

LoopBack Relay

LB363 Series
GLB363 Series

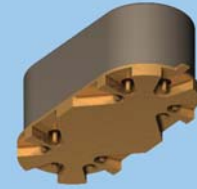

SERIES DESIGNATION	RELAY TYPE
LB363	LoopBack Relay, Sensitive Coil
GLB363	LoopBack Relay, Ground Shield, Surface-Mount (Stub Leads), Sensitive Coil

DESCRIPTION

The LoopBack Series relay combines two DPDT electromechanical relays in one package that includes an internal bypass path for Automated Test Equipment (ATE) applications. The LoopBack combines the technology of two Teledyne RF/GRF300 Series relays which eliminates the need for external PCB traces in loop back test applications. This innovation results in superior signal integrity and RF performance, while taking minimal board space. The LB/GLB363 Series is designed for digital signaling application and provides excellent signal integrity up to 12 Gbps data rates.

The LoopBack relay is available with two different internal paths: Through and AC Bypass. The Through version provides a loop back path across high performance contact material, while the AC Bypass Model adds a coupling capacitor across each loop back path. The internal in-line capacitors allow you to eliminate the footprints for external components, while performing AC bypass functions internal to the relay. The capacitors used feature excellent signal integrity as well as low loss high frequency performance.

A typical loop-back load board application uses the Device Under Test (DUT) to test itself. In this method, the transmitter from the DUT is connected through a loop back path to the

receiver of the DUT. The double pole design of the LoopBack relay is perfectly suited for differential signaling, allowing relay component to provide transmit and receive signals and their inversions to the DUT or through the bypass path.

The internal structure of the LoopBack relay reduces the number of discontinuities and shortens the signal path during loop back testing, providing lower insertion loss and higher signal integrity performance than two RF/GRF303 Series relays. In the normally closed mode (de-energized) the LoopBack relay provides four normally closed contacts. When energized, the moving contacts are connected together across the loop back structure to provide two through paths. The normally closed contacts have similar performance to RF/GRF303 Series relays.

In addition to the thru-hole mount, the LoopBack Series relay is available in through hole surface mount stub leads with a ground shield. The surface mount ground shield used in the stub lead provides improved high data rate and high frequency performance, as well as improved repeatability. Upon request, various ground pin configurations for through lead models are available.

ENVIRONMENTAL AND PHYSICAL SPECIFICATIONS				
Temperature (Ambient)	Storage	-65°C to +125°C	Enclosure	Hermetically sealed
	Operating	-55°C to +85°C		
Vibration (General Note 1)		10 g's to 500 Hz	Shock (General Note 1)	30 g's, 6ms half sine
Weight	LB363	0.16 oz. (4.53g) max.	GLB363	0.18 oz. (5.10g) max.

SERIES LB363/GLB363
TYPICAL RF Characteristics (See RF Notes on next page)

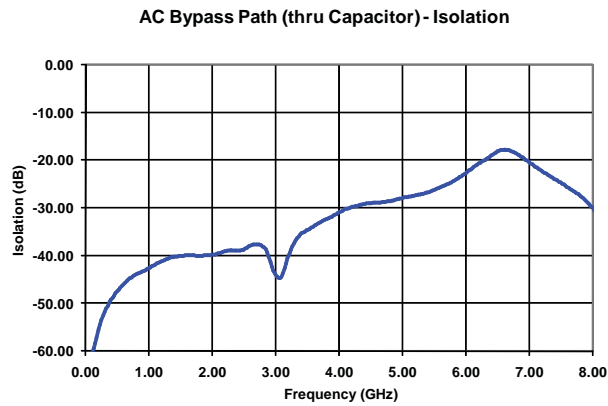
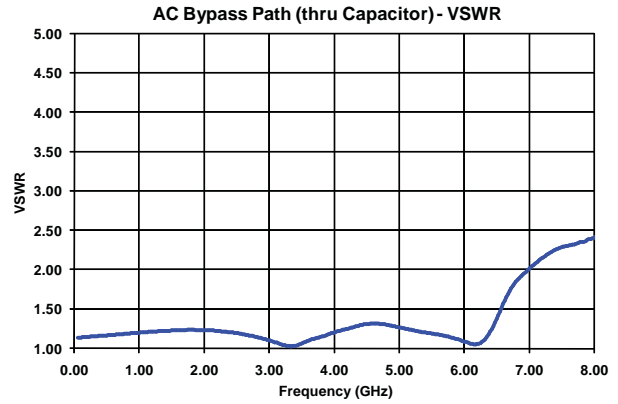
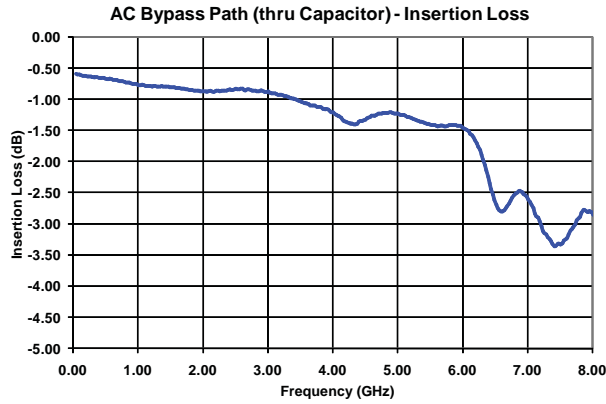

Normally Closed RF Performance

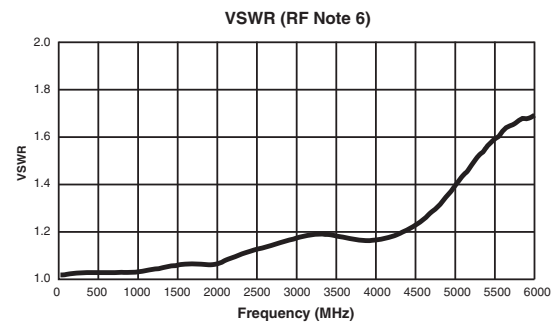
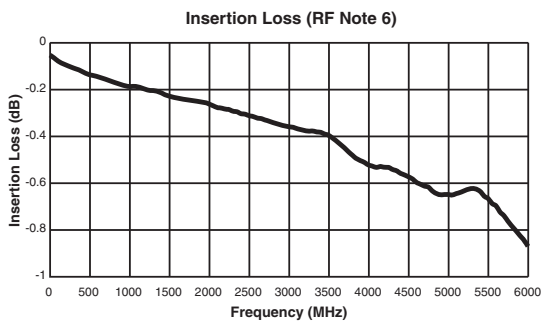
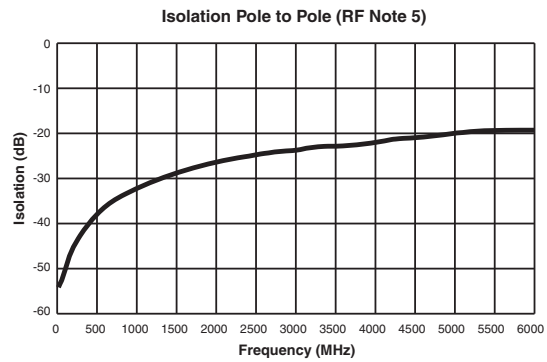
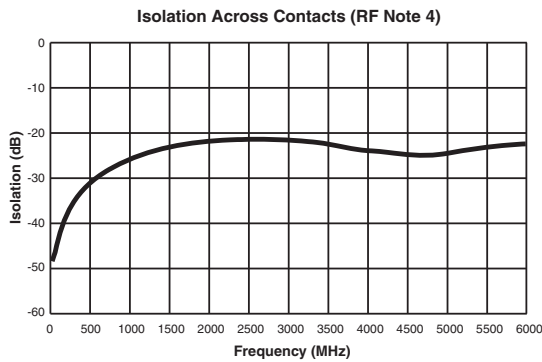

SERIES LB363/GLB363
GENERAL ELECTRICAL SPECIFICATIONS (@ 25 °C unless otherwise noted)

Contact Arrangement	Special (See Schematic on page 5)
Rated Duty	Continuous
Contact Resistance	0.200 Ω max. initial (measured 1/8" from the header)
Contact Load Rating	Resistive: 1Amp/28Vdc Low level: 10 to 50 μ A, 10 to 50 mV
Contact Life Ratings	5,000,000 cycles (typical) at low level
Operate Time	4.0 mS max.
Release Time	3.0 mS max.
Insulation Resistance	1,000 M Ω min. between mutually isolated terminals
Dielectric Strength	350 Vrms (60 Hz) @ atmospheric pressure

DETAILED ELECTRICAL SPECIFICATIONS (@25°C)

BASE PART NUMBERS	LB363-100-5 GLB363-100-5	LB363-100-12 GLB363-100-12
Coil Voltage, Nominal (Vdc)	5.0	12.0
Coil Resistance (Ohms \pm 20%)	56	400
Pick-up Voltage (Vdc max.)	3.6	9.0
Coil Operating Power (mW)	450	360

RF NOTES

- Test conditions:
 - Fixture: .031" copper clad, reinforced PTFE, RT/duroid® 6002 with SMA connectors. (RT/duroid® is a registered trademark of Rogers Corporation.)
 - Room ambient temperature.
 - Terminals not tested were terminated with 50-ohm load.
 - Contact signal level: -10 dBm.
 - No. of test samples: 4.
- Data presented herein represents typical characteristics and is not intended for use as specification limits.
- Data is per pole, except for pole-to-pole data.
- Data is the average from readings taken on all open contacts.
- Data is the average from readings taken on poles with coil energized and de-energized.
- Data is the average from readings taken on all closed contacts.
- Test fixture effect de-embedded from frequency and time response data.

SERIES LB363/GLB363
TYPICAL Single-Ended Signal Integrity Characteristics

AC Bypass Path

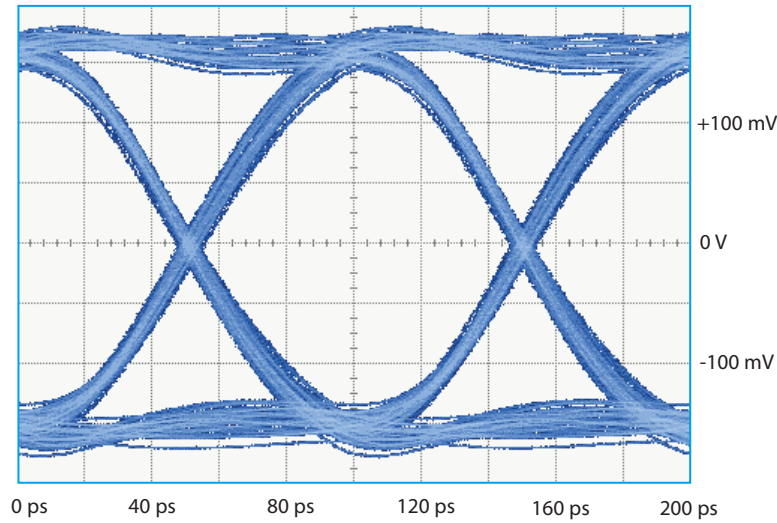

Eye Height	Eye Width	Jitter _{p-p}
254.3 mV	88.64 ps	8.89 ps

SERIES LB363/GLB363
TYPICAL Differential Signal Integrity Characteristics

AC Bypass Path

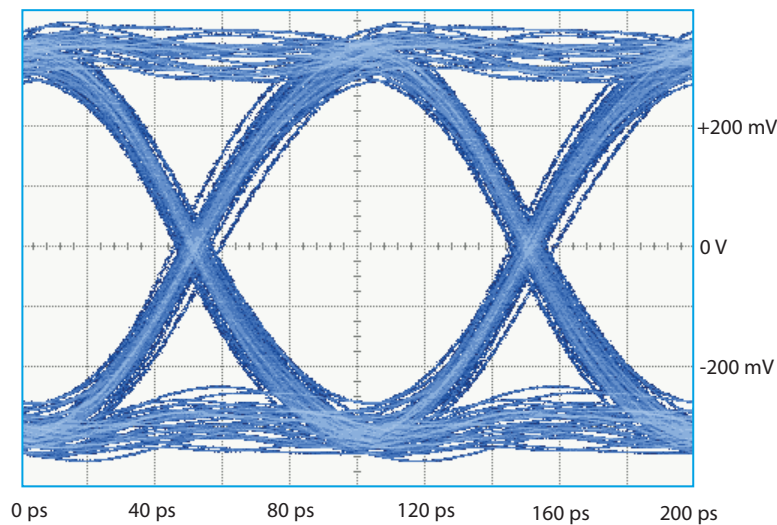

Eye Height	Eye Width	Jitter _{p-p}
492.1 mV	84.29 ps	15.55 ps

**SERIES LB363
OUTLINE DIMENSIONS**

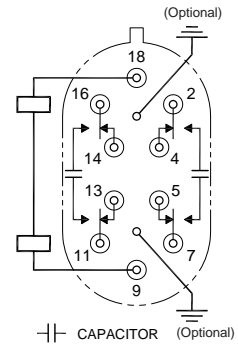
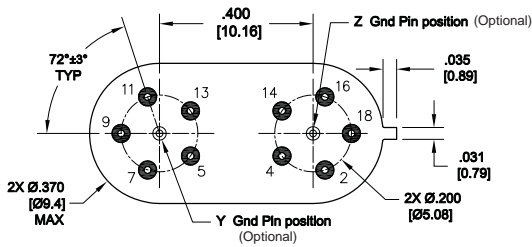
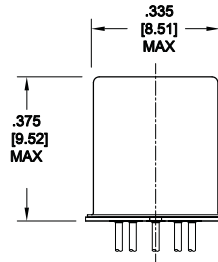
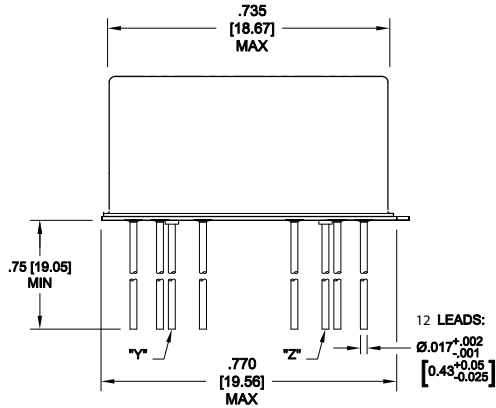

U.S. PATENT PENDING

NOTES:

1. DIMENSIONS ARE IN INCHES. METRIC EQUIVALENTS (MILLIMETERS) ARE SHOWN IN [X.XX].
2. TOLERANCE (UNLESS OTHERWISE SPECIFIED): ±.010 INCH [±0.025 mm]

SCHEMATIC - TERMINAL VIEW
PIN NUMBERS ARE FOR REFERENCE ONLY, NOT MARKED ON RELAY

CONTACT ARRANGEMENT

- N.C. SIDE (COILS DE-ENERGIZED):
4PST, NORMALLY CLOSED
- N.O. SIDE (COILS ENERGIZED):
DPST, NORMALLY OPEN,
DOUBLE MAKE

Teledyne Part Numbering System for LoopBack Relays

LB363 YZ - 100 - 5

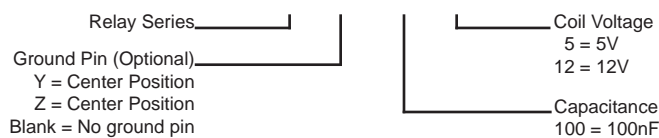

SERIES GLB363
OUTLINE DIMENSIONS

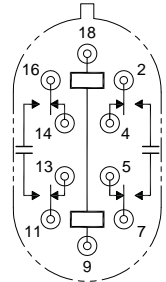
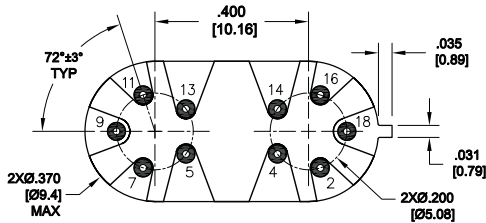
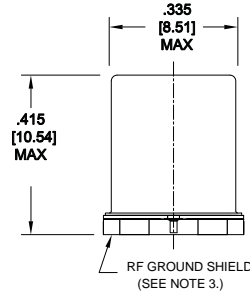
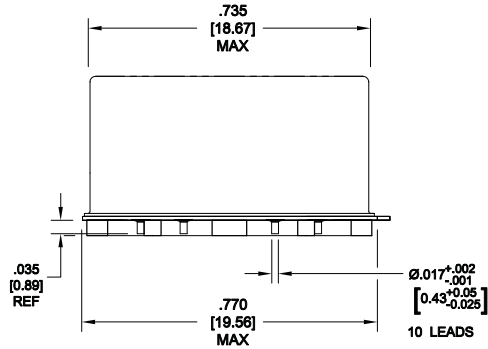

—||— CAPACITOR

SCHEMATIC - TERMINAL VIEW
PIN NUMBERS ARE FOR REFERENCE ONLY, NOT MARKED ON RELAY

NOTES:

1. DIMENSIONS ARE IN INCHES. METRIC EQUIVALENTS (MILLIMETERS) ARE SHOWN IN [X.XX].
2. TOLERANCE (UNLESS OTHERWISE SPECIFIED): ±.010 INCH [±0.025 mm]
3. FOR BEST RF PERFORMANCE, SOLDER BOTTOM OF RF GROUND SHIELD TO RF GROUND PLANE OF PC BOARD.

CONTACT ARRANGEMENT

- N.C. SIDE (COILS DE-ENERGIZED):
4PST, NORMALLY CLOSED
- N.O. SIDE (COILS ENERGIZED):
DPST, NORMALLY OPEN,
DOUBLE MAKE

Teledyne Part Numbering System for LoopBack Relays

GLB363 - 100 - 5

Relay Series _____

Coil Voltage
5 = 5V
12 = 12V

Capacitance
100 = 100nF

SERIES LB363/GLB363
APPLICATION NOTE

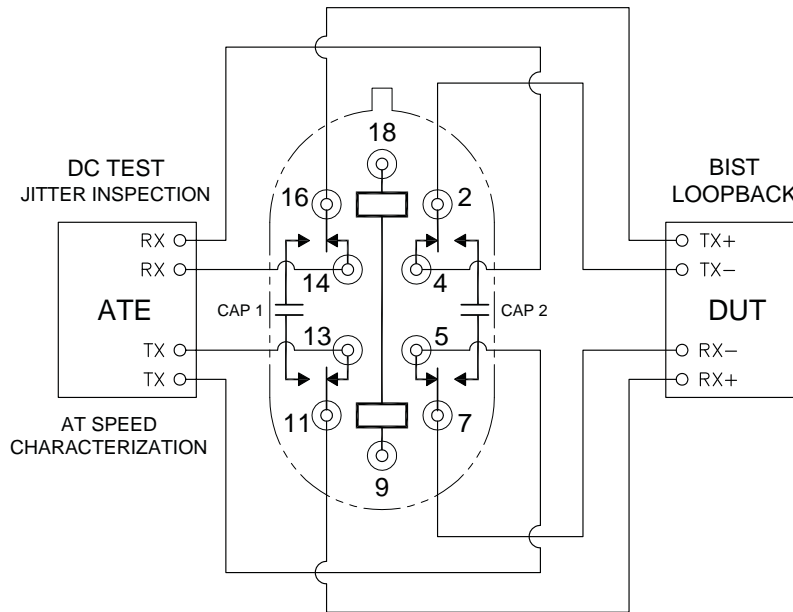

(Contacts shown in *De-Energized* position)

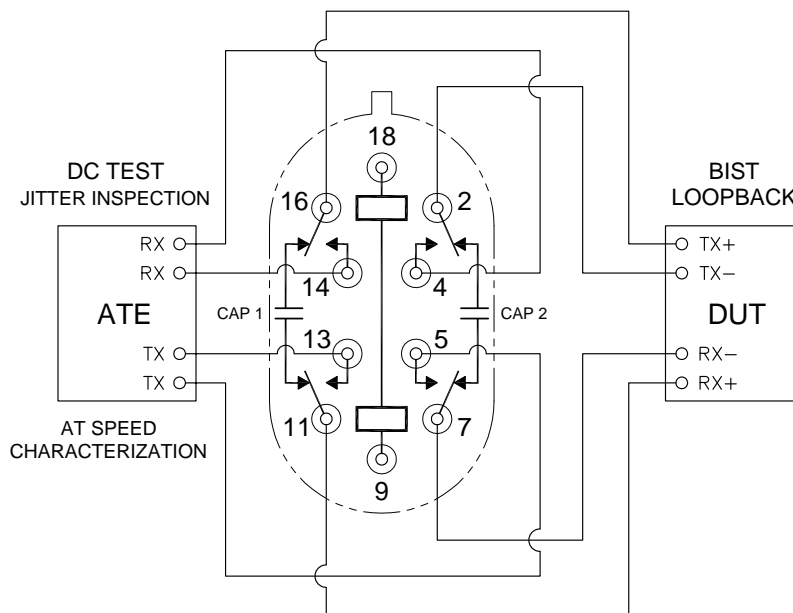

(Contacts shown in *Energized* position)

NOTES:
Coil Pins 9&18 are not polarity sensitive.
Relay pins is bottom view.