

SMD/BLOCK Type EMI Suppression Filters EMIFIL[®]





EU RoHS Compliant

- All the products in this catalog comply with EU RoHS.
- EU RoHS is "the European Directive 2011/65/EU on the Restriction of the Use of Certain Hazardous Substances in Electrical and Electronic Equipment."
- For more details, please refer to our web page, "Murata's Approach for EU RoHS" (<http://www.murata.com/en-eu/support/compliance/rohs>).

Contents

Product specifications are as of September 2018.

| | |
|--|-----|
| Selection Guide for Noise Suppression Filters | p2 |
| EMI Filter Selection by Application | p4 |
| • Digital Still Camera | p4 |
| • Smartphone | p5 |
| • Blu-ray/DVD | p6 |
| • LCD-TV | p7 |
| EMI Filter Selection by Circuits and Noise Frequency | p8 |
| Product Guide | p10 |

Chip Ferrite Bead BLM/BLA/BLT Series

| | |
|------------------------------|------|
| Series Introduction | p16 |
| Part Numbering | p18 |
| Series Lineup | p19 |
| Product Detail | p26 |
| ⚠Caution/Notice | p110 |
| Soldering and Mounting | p111 |
| Packaging | p115 |

Application Specified Noise Filter NFZ_S/NFZ_B/BLF/BLE/LQW_CA Series

| | |
|---|------|
| Part Numbering | p118 |
| Series Lineup | p122 |
| Product Detail | |
| Noise filter for audio lines | p126 |
| Noise filter for LED lighting equipment | p133 |
| Frequency specified noise filter | p142 |
| Noise filter for power charger lines | p145 |
| Inductor for audio line noise suppression | p147 |
| ⚠Caution/Notice | p151 |
| Soldering and Mounting | p154 |
| Packaging | p160 |

Chip EMIFIL® NFL/NFA/NFW/NFE Series

| | |
|------------------------------|------|
| Series Introduction | p166 |
| Part Numbering | p168 |
| Series Lineup | p170 |
| Product Detail | p172 |
| ⚠Caution/Notice | p185 |
| Soldering and Mounting | p186 |
| Packaging | p190 |

Common Mode Choke Coil · Common Mode Noise Filter DLM/DLP/DLW/NFP/PLT Series

| | |
|------------------------------|------|
| Series Introduction | p192 |
| Part Numbering | p194 |
| Series Lineup | p198 |
| Product Detail | p202 |
| ⚠Caution/Notice | p240 |
| Soldering and Mounting | p243 |
| Packaging | p250 |

Block Type EMIFIL® BNX Series

| | |
|--------------------------------------|------|
| Series Lineup/Function Example | p254 |
| Product Detail | p256 |
| ⚠Caution/Notice | p260 |
| Soldering and Mounting | p262 |
| Packaging | p266 |

EMC Absorber EA20/EA21 Series



| | |
|----------------------|------|
| Part Numbering | p268 |
| Product Detail | p269 |
| Notice | p270 |

| | |
|--|------|
| Part Number Quick Reference | p271 |
| Introduction of Related Catalogs | p272 |
| Noise Suppression Basic Course | p273 |

Please check the MURATA website (<https://www.murata.com/>) if you cannot find a part number in this catalog.

Selection Guide for Noise Suppression Filters

Features & Suitable Circuits

| Type Representative series name | Features | Suitable Circuits |
|--|--|---|
| Ferrite Bead BLM/BLA Series  | <ul style="list-style-type: none"> · Miniaturized · GND connection unnecessary · Effective at low impedance line | <ul style="list-style-type: none"> · Application set with less noise radiation · Low impedance line |
| Capacitor Type NFM/NFA/NFE/ NFL/NFW Series  | <ul style="list-style-type: none"> · Great noise suppression effect · With effect as bypass capacitor (Lineup for Power) · Good noise separation from signal (LC filter for Signal) · Effective at high impedance line | <ul style="list-style-type: none"> · Application set with higher noise radiation · High impedance line · Circuit with bypass capacitor · Circuit driven by high frequency |
| Common Mode Choke Coil DLW/DLM/DLP Series  | <ul style="list-style-type: none"> · Possible to suppress noise with less affect of ultra-high-speed signal · Significant improvement in common mode noise · Less magnetic saturation by current | <ul style="list-style-type: none"> · High-speed differential signal line · I/F cable driver · Power line |

Example

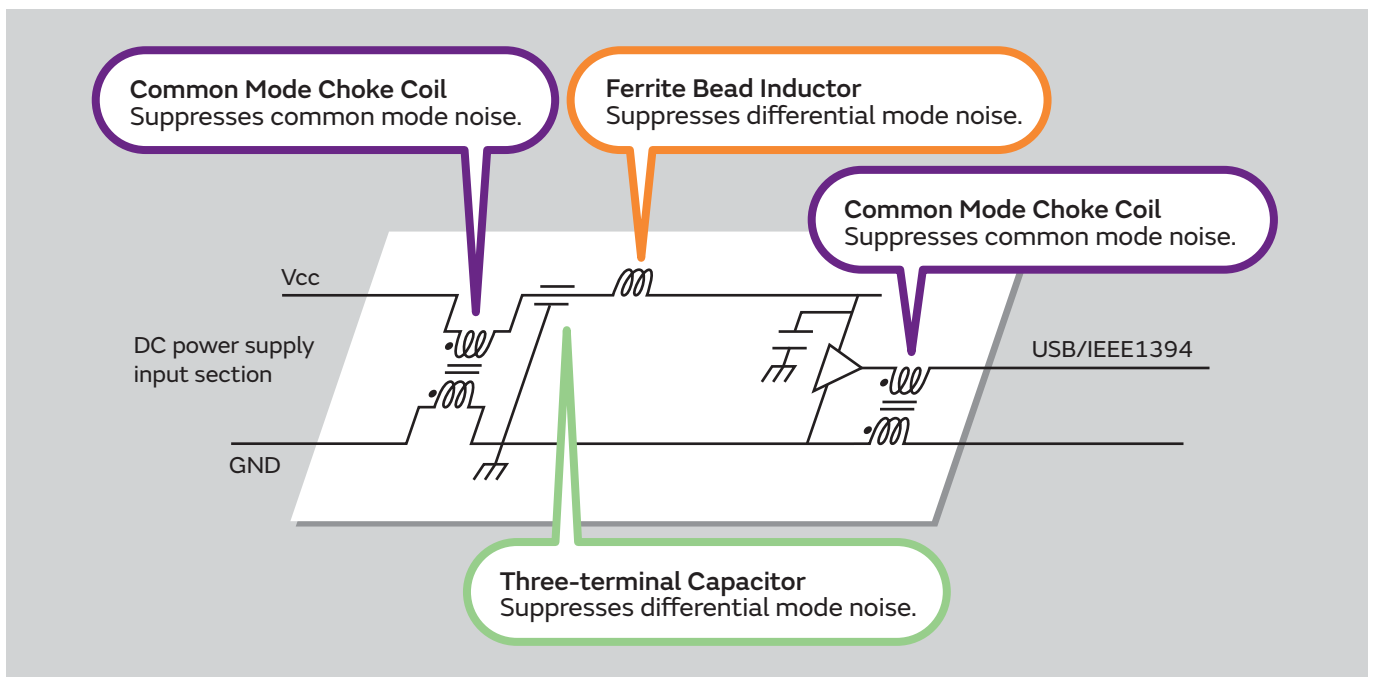

Selection Guide for Noise Suppression Filters

Advantages to Using Common Mode Choke Coils

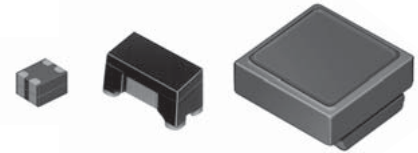

1. Great Effect for Common Mode Noise

Differential mode inductors work as a half impedance for common mode noise. Common Mode Choke Coils are effective for common mode noise.

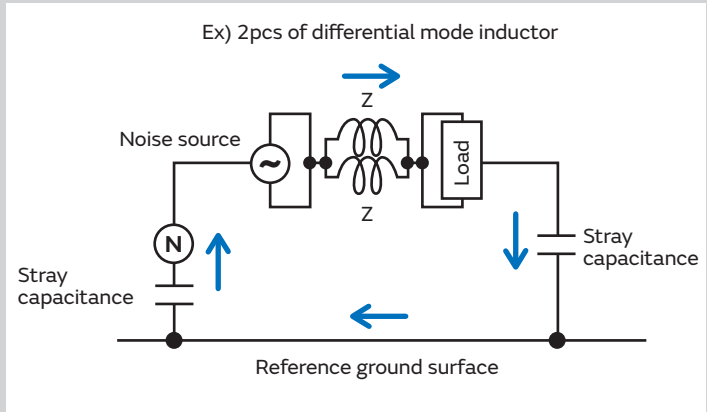

2. Possible to Suppress Noise with Less Effect on the Ultra-High-Speed Signal

Common Mode Choke Coils can suppress Noise with less effect on the Signal, even if the frequency range of Signal and Noise are the same, because they separate each conductive mode of current.

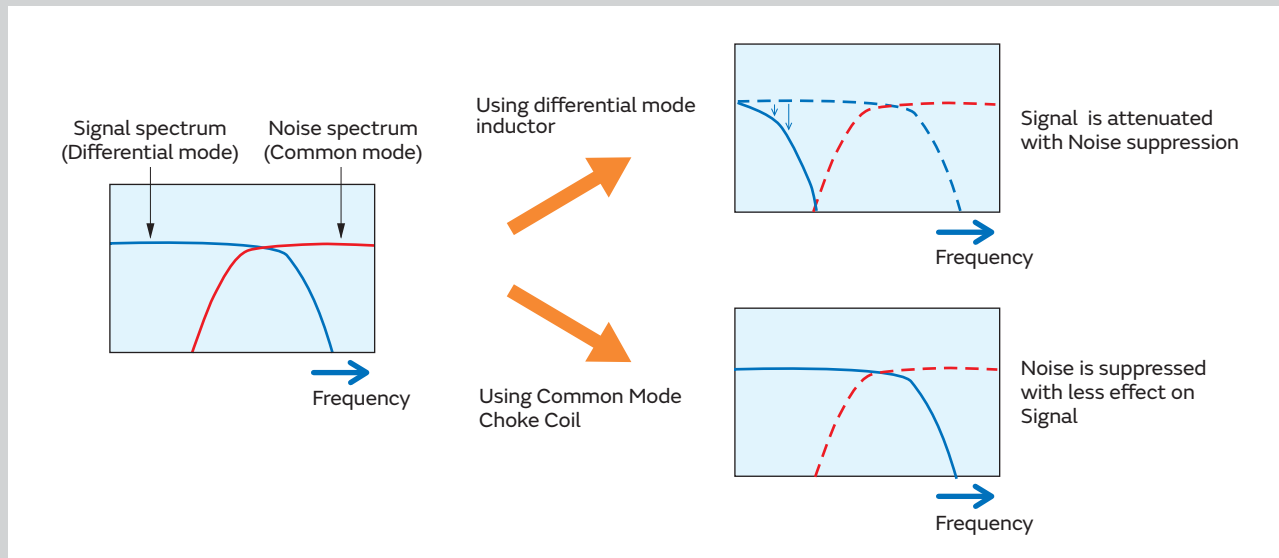

3. Less Magnetic Saturation by Current

Common Mode Choke Coils are effective for noise suppression of DC power lines, due to their less magnetic saturation at high power current, which comes from their construction of cancelling magnetic flux of the differential mode current at each coil.

EMI Filter Selection by Application

Digital Still Camera Application Sample

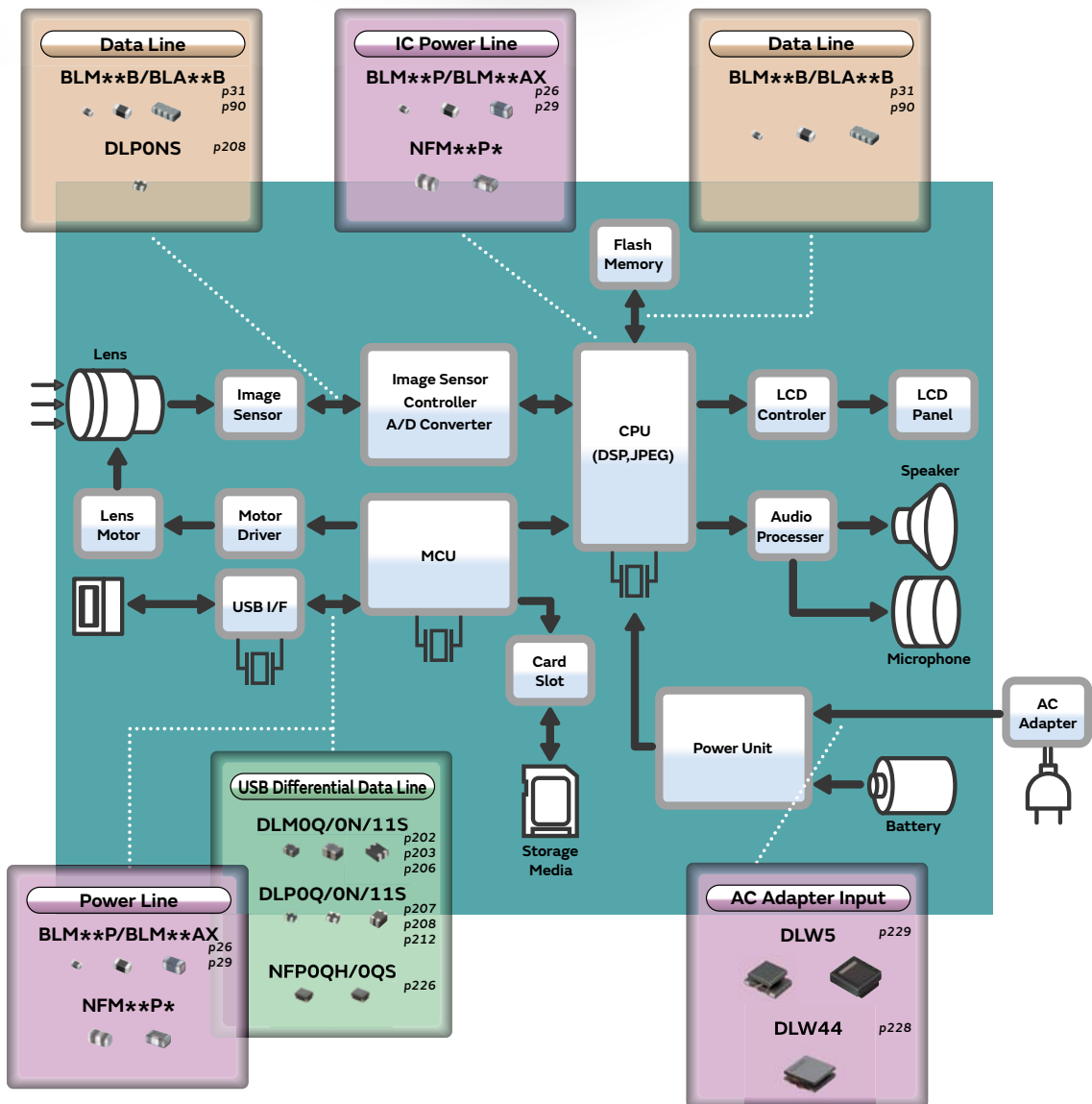

EMI Filter Selection by Application

Smartphone Application Sample

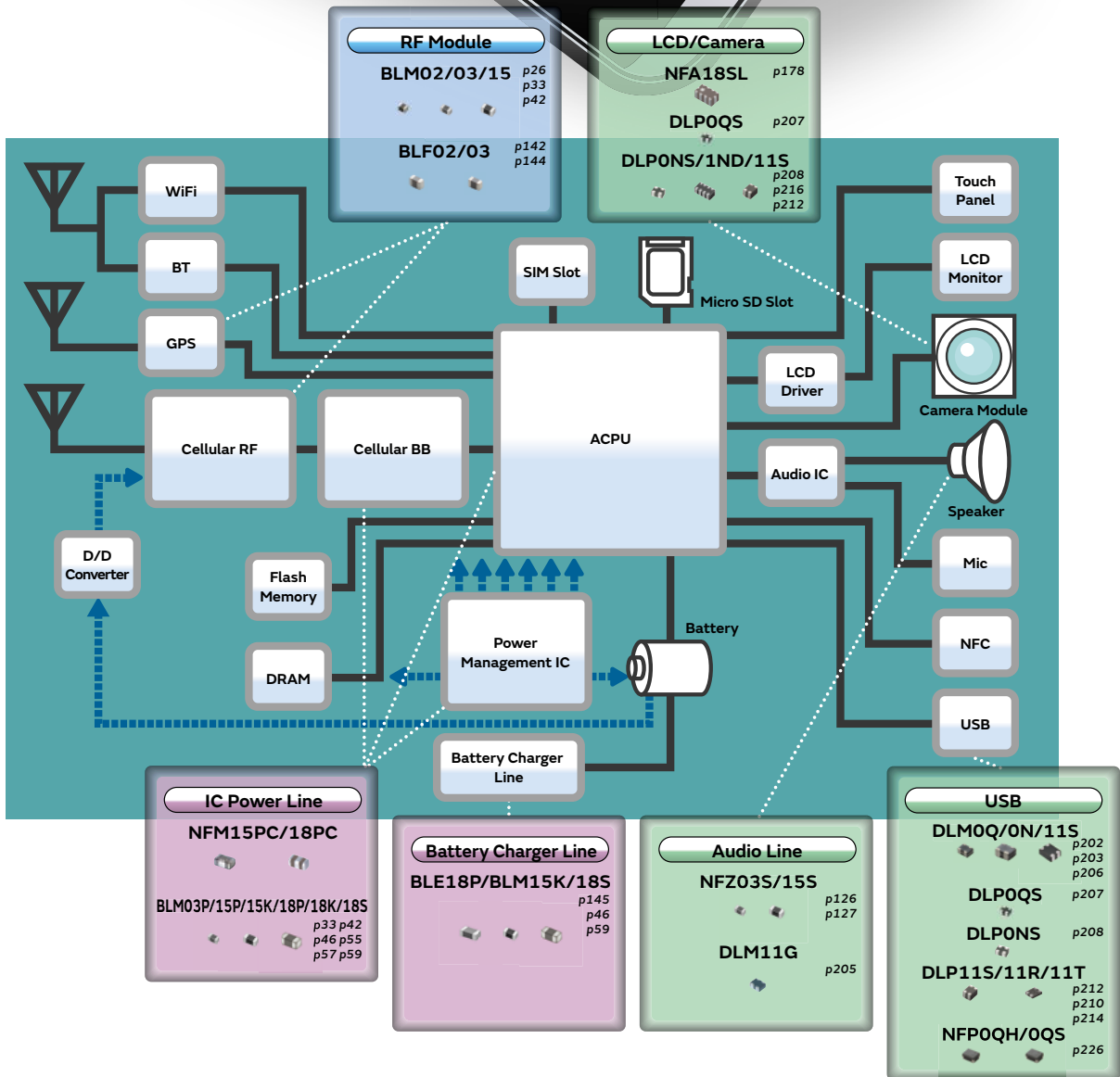

EMI Filter Selection by Application

Blu-ray/DVD Application Sample

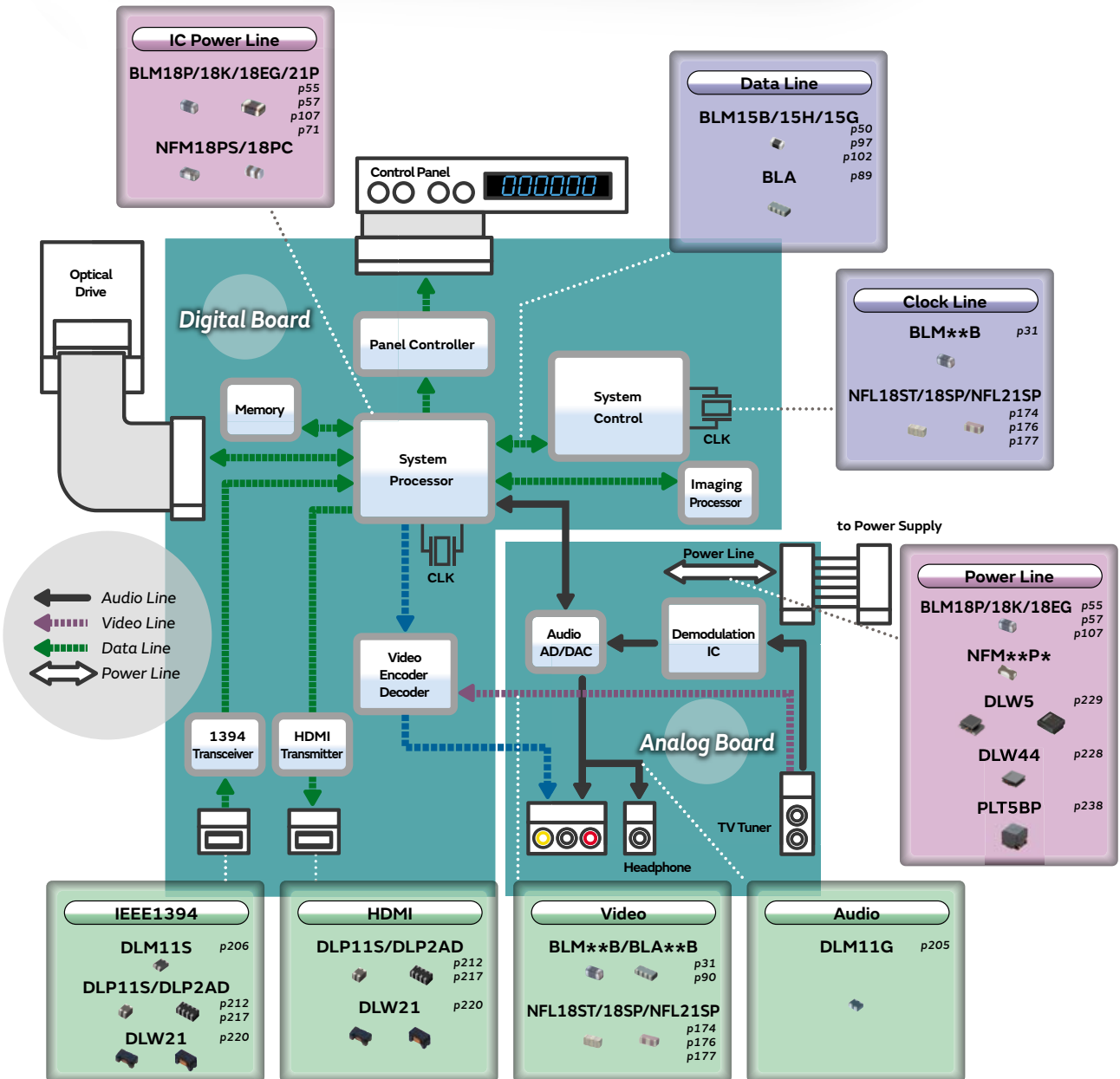

EMI Filter Selection by Application

LCD-TV Application Sample

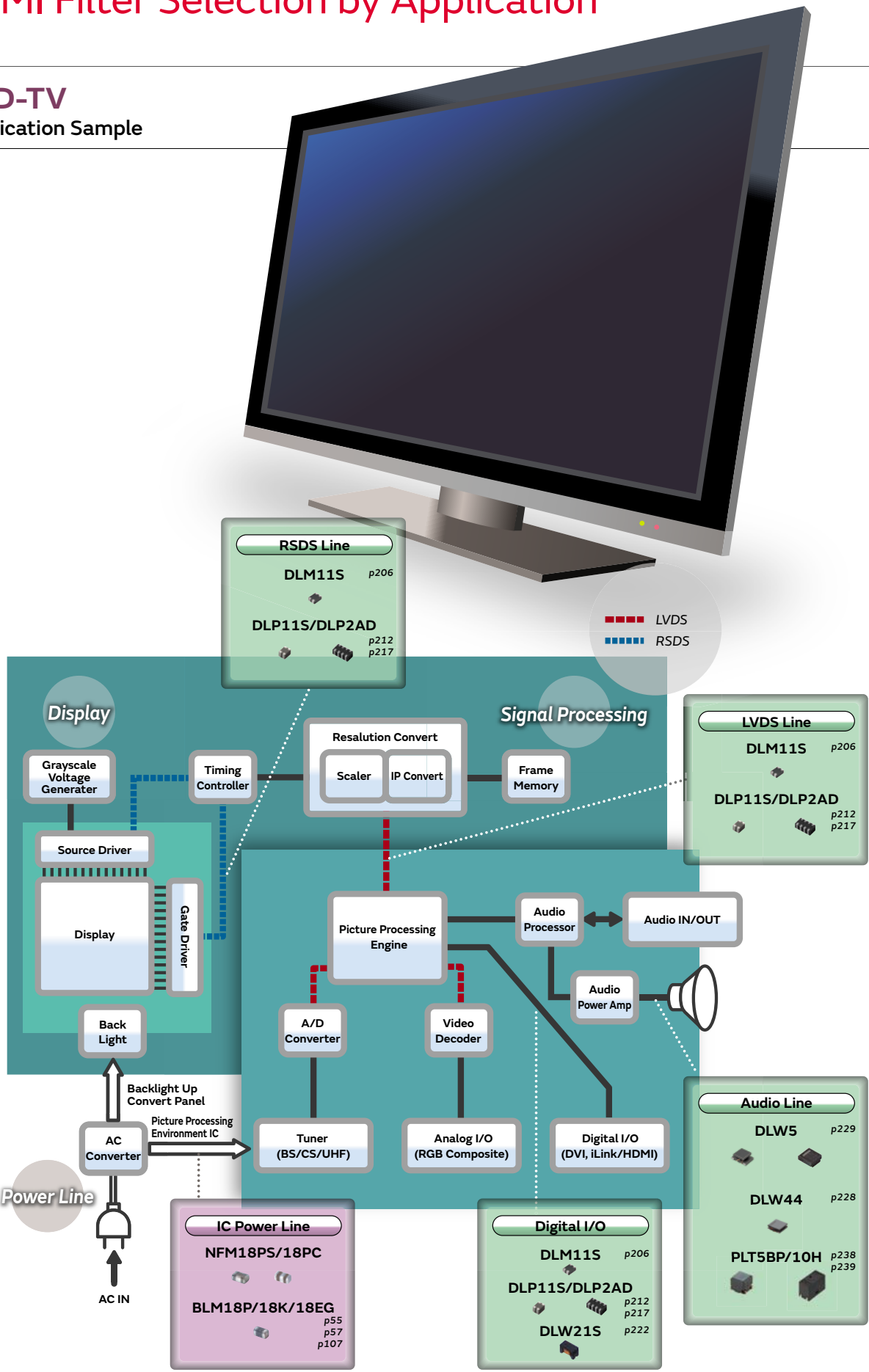

EMI Filter Selection by Circuits and Noise Frequency

Chip Ferrite Bead / Chip EMIFIL[®]

| | | Circuit Type | | | |
|-----------------|---|---|--|---|--|
| | | Power Line | General Signal Line Under 10MHz | High-Speed Signal Line Over 10MHz | |
| Noise Frequency | Noise Frequency: Under 1GHz | Inductor Type (Suppression Effect: Normal) | <ul style="list-style-type: none"> • BLF02JD 01005(0402) p142 • BLM02AX 01005(0402) p29 • BLF03JD 0201(0603) p144 • BLM03AX 0201(0603) p38 | <ul style="list-style-type: none"> • BLM02BX/BC/BB 01005(0402) p31 • BLM03B 0201(0603) p39 • BLM15BX 0402(1005) p53 • BLM15B 0402(1005) p50 • BLM18B 0603(1608) p65 • BLM21B 0805(2012) p77 | |
| | | | <ul style="list-style-type: none"> • BLM03PG 0201(0603) p33 | <ul style="list-style-type: none"> • BLM03AG 0201(0603) p36 • BLM15AG 0402(1005) p47 • BLM18A 0603(1608) p62 | |
| | | | Low DC Resistance / High Current Type | | |
| | | | <ul style="list-style-type: none"> • BLM02PX 01005(0402) p26 • BLM02KX 01005(0402) p28 • BLM03PX 0201(0603) p34 | | |
| | | | | <ul style="list-style-type: none"> • BLM15AX 0402(1005) p48 | |
| | | | <ul style="list-style-type: none"> • BLM15PX 0402(1005) p44 • BLM15P 0402(1005) p42 • BLM15KD 0402(1005) p46 • BLM18P 0603(1608) p55 • BLE18P 0603(1608) p145 • BLM21P 0805(2012) p71 • BLM31P 1206(3216) p83 • BLE32P 1210(3225) p146 • BLM41P 1806(4516) p86 | <ul style="list-style-type: none"> • BLM18T 0603(1608) p64 • BLM18R 0603(1608) p69 • BLM21A 0805(2012) p75 • BLM21R 0805(2012) p80 | |
| | | | | Array Type | |
| | | | <ul style="list-style-type: none"> • BLA2AA 0804(2010) p89 • BLA31A 1206(3216) p92 | <ul style="list-style-type: none"> • BLA2AB 0804(2010) p90 • BLA31B 1206(3216) p93 | |
| | | | | Low DC Resistance Type | |
| | | | <ul style="list-style-type: none"> • BLM18K 0603(1608) p57 • BLM18S 0603(1608) p59 • BLM21S 0805(2012) p73 • BLM31S 1206(3216) p85 • BLM31KN 1206(3216) p81 • BLT5BPT 2020(5050) p88 | | |
| Noise Frequency | Noise Frequency: GHz Band (800MHz to 2.5GHz) | Capacitor Type (Suppression Effect: High) | T Circuit Filter Feed-Through Type | LC Combined | |
| | | | <ul style="list-style-type: none"> • NFE31PT 1206(3216) p172 • NFE61PT 2706(6816) p173 | <ul style="list-style-type: none"> • NFL18ST 0603(1608) p174 • NFL18SP 0603(1608) p176 • NFL21SP 0805(2012) p177 • NFW31SP 1206(3216) p184 | |
| | | | Block Type | Array Type (LC Combined) | |
| | | | <ul style="list-style-type: none"> • BNX022/023/028/029 p256 | <ul style="list-style-type: none"> • NFA18SL/SD 0603(1608) p178 • NFA21SL 0805(2012) p182 | |
| | | | | | |
| Noise Frequency | Noise Frequency: GHz Band (1GHz to 10GHz) | Inductor Type (Suppression Effect: Normal) | <ul style="list-style-type: none"> • BLF02RD 01005(0402) p143 • BLM18HE 0603(1608) p103 | <ul style="list-style-type: none"> • BLM03HG 0201(0603) p94 • BLM15HG 0402(1005) p97 • BLM18HG 0603(1608) p103 • BLM18HK 0603(1608) p103 | <ul style="list-style-type: none"> • BLM03HD 0201(0603) p94 • BLM03HB 0201(0603) p94 • BLM15HD 0402(1005) p97 • BLM15HB 0402(1005) p97 • BLM18HD 0603(1608) p103 • BLM18HE 0603(1608) p103 • BLM18HB 0603(1608) p103 |
| | | | <ul style="list-style-type: none"> • BLM03E 0201(0603) p96 • BLM15E 0402(1005) p99 • BLM18E 0603(1608) p107 | | |
| | | | | LC Combined | |
| | | | | <ul style="list-style-type: none"> • NFL18ST 0603(1608) p174 | |
| Noise Frequency | Noise Frequency: High-Chip Band (1GHz to 10GHz) | Inductor Type | <ul style="list-style-type: none"> • BLM15GG 0402(1005) p102 • BLM18G 0603(1608) p109 | <ul style="list-style-type: none"> • BLM15GA 0402(1005) p102 | |
| | | | | Array Type (LC Combined) | |
| | | | | <ul style="list-style-type: none"> • NFA18SL/SD 0603(1608) p178 • NFA21SL 0805(2012) p182 | |

Noise Filter for Audio Line

| | | Circuit Type | |
|-----------------|-----------------------------|--|--|
| | | Noise Filter For Audio Line | |
| | | Earphone | Speaker |
| Noise Frequency | Noise Frequency: Under 1GHz | | NFZ18SM_10 0603(1608) ^{p129} NFZ2MSM_10 0806(2016) ^{p131} NFZ32SW_10 1210(3225) ^{p132} |
| | Noise Frequency: Over 1GHz | NFZ03SG_10 0201(0603) ^{p126} NFZ15SG_10 0402(1005) ^{p127} | NFZ15SG_11 0402(1005) ^{p127} |

Noise Filter for LED Line

| | | Circuit Type | |
|-----------------|-----------------------------|---|--|
| | | Noise Filter For LED Lighting Equipment | |
| Noise Frequency | Noise Frequency: Under 1MHz | | NFZ2HBM_10 1008(2520) ^{p133} NFZ32BW_11 1210(3225) ^{p135} NFZ32BW_10 1210(3225) ^{p135} NFZ5BBW_10 2020(5050) ^{p139} |

Chip Common Mode Choke Coils

| Circuit Type | | | | |
|--|---|--|--|--|
| DC Power Line | High Speed Differential Signal Line | | Audio Line | |
| | High-Speed Signal Line (USB2.0/LVDS/IEEE1394/mipi etc.) | Ultra-High-Speed Differential Signal Line (HDMI/DVI/Display Port/USB3.0 etc.) | | |
| DLW44S 1515(4040) ^{p228} DLW5AH 2014(5036) ^{p229} DLW5AT 2014(5036) ^{p231} DLW5BS 2020(5050) ^{p229} DLW5BT 2020(5050) ^{p236} High Current Type PLT10HH 12.9mm×6.6mm ^{p239} PLT5BPH 2020(5050) ^{p238} | DLM0QSN 025020(0605) ^{p202} DLM0NSN 03025(0806) ^{p203} DLM11S 0504(1210) ^{p206} DLP0NSC 03025(0806) ^{p208} DLP0NSN 03025(0806) ^{p208} DLP11SN 0504(1210) ^{p212} DLP11RN 0504(1210) ^{p210} DLW21H 0805(2012) ^{p220} DLW21S_S 0805(2012) ^{p222} DLW21S_X 0805(2012) ^{p222} DLP31S 1206(3216) ^{p215} DLW31S 1206(3216) ^{p225} | NFPOQHB 025020(0605) ^{p226} NFPOQSB 025020(0605) ^{p226} DLMOQSB 025020(0605) ^{p202} DLPOQSA 025020(0605) ^{p207} DLMONSB 03025(0806) ^{p203} DLP0NSA 03025(0806) ^{p208} DLP11SA 0504(1210) ^{p212} DLP11RB 0504(1210) ^{p210} DLP11TB 0504(1210) ^{p214} DLW21S_HQ 0805(2012) ^{p222} | DLM11G 0504(1210) ^{p205} DLW5AT 2014(5036) ^{p231} DLW5BT 2020(5050) ^{p236} | |
| | | Array Type DLP1ND 05025(1506) ^{p216} DLP2ADN 0804(2010) ^{p217} DLP31D 1206(3216) ^{p219} | Array Type DLP2ADA 0804(2010) ^{p217} | |

Product Guide

BLM/BLA/BLT

Chip Ferrite Bead

| Part Number | Size Code in inches (mm) | Impedance | | Rated Current | |
|-------------------------------|-----------------------------|--------------|----------------|---------------|----------------|
| | | at 100MHz | at 1GHz | | |
| BLM02PX* | p26 | 01005 (0402) | 10Ω to 60Ω | - | 500mA to 1.1A |
| BLM02KX* | p28 | 01005 (0402) | 10Ω to 18Ω | - | 1.2A to 1.5A |
| BLM02AX | p29 | 01005 (0402) | 10Ω to 240Ω | - | 200mA to 750mA |
| BLM02BB/BC | p31 | 01005 (0402) | 10Ω to 100Ω | 95Ω to 240Ω | 125mA to 250mA |
| BLM02BX* | p32 | 01005 (0402) | 120Ω to 240Ω | - | 240mA to 350mA |
| BLM03PG | p33 | 0201 (0603) | 22Ω to 33Ω | - | 750mA to 900mA |
| BLM03PX* | p34 | 0201 (0603) | 22Ω to 120Ω | - | 900mA to 1.8A |
| BLM03AG | p36 | 0201 (0603) | 10Ω to 1000Ω | - | 100mA to 500mA |
| BLM03AX | p38 | 0201 (0603) | 10Ω to 1000Ω | - | 200mA to 1A |
| BLM03BB/BC/BD | p39 | 0201 (0603) | 10Ω to 600Ω | - | 100mA to 300mA |
| BLM03BX | p41 | 0201 (0603) | 1000Ω to 1800Ω | - | 140mA to 170mA |
| BLM15PD*/PG | p42 | 0402 (1005) | 10Ω to 120Ω | - | 1A to 2.2A |
| BLM15PX* | p44 | 0402 (1005) | 33Ω to 600Ω | - | 900mA to 3A |
| BLM15KD* | p46 | 0402 (1005) | 20Ω to 120Ω | - | 1.5A to 3.8A |
| BLM15AG | p47 | 0402 (1005) | 10Ω to 1000Ω | - | 300mA to 1A |
| BLM15AX | p48 | 0402 (1005) | 10Ω to 1000Ω | - | 350mA to 1.74A |
| BLM15BA/BB/BC/BD | p50 | 0402 (1005) | 5Ω to 1800Ω | - | 100mA to 500mA |
| BLM15BX | p53 | 0402 (1005) | 75Ω to 1800Ω | - | 250mA to 600mA |
| BLM18PG* | p55 | 0603 (1608) | 30Ω to 470Ω | - | 1A to 3A |
| BLM18KG* | p57 | 0603 (1608) | 26Ω to 1000Ω | - | 1A to 6A |
| BLM18SD*/SG*/SN* | p59 | 0603 (1608) | 22Ω to 330Ω | - | 1.5A to 8A |
| BLM18AG | p62 | 0603 (1608) | 120Ω to 1000Ω | - | 450mA to 800mA |
| BLM18TG | p64 | 0603 (1608) | 120Ω to 1000Ω | - | 100mA to 200mA |
| BLM18BA/BB/BD | p65 | 0603 (1608) | 5Ω to 2500Ω | - | 150mA to 800mA |
| BLM18RK | p69 | 0603 (1608) | 120Ω to 1000Ω | - | 200mA |
| BLM21PG* | p71 | 0805 (2012) | 22Ω to 330Ω | - | 1.5A to 6A |
| BLM21SN*/SP* | p73 | 0805 (2012) | 30Ω to 1000Ω | - | 1.6A to 8.5A |
| BLM21AG | p75 | 0805 (2012) | 120Ω to 1000Ω | - | 600mA to 1A |
| BLM21BB/BD | p77 | 0805 (2012) | 5Ω to 2700Ω | - | 200mA to 1A |
| BLM21RK | p80 | 0805 (2012) | 120Ω to 1000Ω | - | 200mA |
| BLM31KN* | p81 | 1206 (3216) | 120Ω to 1000Ω | - | 2A to 6A |
| BLM31PG* | p83 | 1206 (3216) | 33Ω to 600Ω | - | 1.5A to 6A |
| BLM31SN* | p85 | 1206 (3216) | 50Ω | - | 12A |
| BLM41PG* | p86 | 1806 (4516) | 60Ω to 1000Ω | - | 1.5A to 6A |
| BLT5BPT_LN1* | p88 | 2020 (5050) | 68Ω | - | 11A |
| BLA2AAG (4 circuits array) | p89 | 0804 (2010) | 120Ω to 1000Ω | - | 50mA to 100mA |
| BLA2ABB/BD (4 circuits array) | p90 | 0804 (2010) | 10Ω to 1000Ω | - | 50mA to 200mA |
| BLA31AG (4 circuits array) | p92 | 1206 (3216) | 30Ω to 1000Ω | - | 50mA to 200mA |
| BLA31BD (4 circuits array) | p93 | 1206 (3216) | 120Ω to 1000Ω | - | 50mA to 150mA |
| BLM03HB/HD/HG | p94 | 0201 (0603) | 190Ω to 1800Ω | 750Ω to 3000Ω | 100mA to 200mA |
| BLM03EB* | p96 | 0201 (0603) | 25Ω to 50Ω | 105Ω to 255Ω | 400mA to 600mA |
| BLM15HB/HD/HG | p97 | 0402 (1005) | 120Ω to 1800Ω | 500Ω to 2700Ω | 200mA to 300mA |
| BLM15EG* | p99 | 0402 (1005) | 120Ω to 220Ω | 145Ω to 270Ω | 700mA to 1.5A |
| BLM15EX* | p100 | 0402 (1005) | 120Ω to 470Ω | 170Ω to 630Ω | 950mA to 1.8A |
| BLM15GA/GG | p102 | 0402 (1005) | 75Ω to 470Ω | 600Ω to 1200Ω | 200mA to 300mA |
| BLM18HB/HD/HE*/HG/HK | p103 | 0603 (1608) | 120Ω to 1500Ω | 400Ω to 1700Ω | 50mA to 800mA |
| BLM18EG* | p107 | 0603 (1608) | 100Ω to 600Ω | 140Ω to 700Ω | 500mA to 2A |
| BLM18GG | p109 | 0603 (1608) | 470Ω | 1800Ω | 200mA |

* The derating of rated current is required for some items according to the operating temperature on each product page.

NFZ_S

Noise filter for audio lines

| Part Number | Size Code in inches (mm) | Impedance | | | | Rated Current |
|-------------|-----------------------------|--------------|--------------|---------------|---------------|------------------|
| | | at 1MHz | at 100MHz | at 900MHz | at 1.7GHz | |
| NFZ03SG | p126 0201 (0603) | - | - | 330Ω to 1600Ω | 400Ω to 1200Ω | 180mA to 305mA |
| NFZ15SG | p127 0402 (1005) | - | - | 100Ω to 4600Ω | 160Ω to 1800Ω | 270mA to 1.1A |
| NFZ18SM* | p129 0603 (1608) | - | 120Ω to 700Ω | - | - | 800mA to 1.25A |
| NFZ2MSM | p131 0806 (2016) | - | 100Ω to 600Ω | - | - | 2.5A to 4A |
| NFZ32SW | p132 1210 (3225) | 3.2Ω to 6.8Ω | 300Ω to 900Ω | - | - | 2.05A to 2.55A |

* The derating of rated current is required for some items according to the operating temperature on each product page.

NFZ_B

Noise filter for LED lighting equipment

| Part Number | Size Code in inches (mm) | Impedance (at 1MHz) | Rated Current |
|-------------|-----------------------------|------------------------|---------------|
| NFZ2HBM | p133 1008 (2520) | 1.5Ω to 60Ω | 400mA to 1.2A |
| NFZ32BW* | p135 1210 (3225) | 3.3Ω to 880Ω | 200mA to 2.9A |
| NFZ5BBW* | p139 2020 (5050) | 2.9Ω to 140Ω | 1.05A to 4A |

* The derating of rated current is required for some items according to the operating temperature on each product page.

BLF

Frequency specified noise filter

| Part Number | Size Code in inches (mm) | Target Frequency | Rated Current |
|-------------|-----------------------------|------------------|----------------|
| BLF02JD* | p142 01005 (0402) | 700MHz | 330mA to 380mA |
| BLF02RD* | p143 01005 (0402) | 2.4GHz | 200mA to 330mA |
| BLF03JD* | p144 0201 (0603) | 700MHz | 480mA |

* The derating of rated current is required for some items according to the operating temperature on each product page.

BLE

Noise filter for power charger lines

| Part Number | Size Code in inches (mm) | Impedance (at 100MHz) | Rated Current |
|-------------|-----------------------------|--------------------------|---------------|
| BLE18PS* | p145 0603 (1608) | 8.5Ω | 8A |
| BLE32PN | p146 1210 (3225) | 26Ω to 30Ω | 10A |

* The derating of rated current is required for some items according to the operating temperature on each product page.

LQW_CA

Inductor for audio line noise suppression

| Part Number | Size Code in inches (mm) | Inductance | Rated Current |
|-------------|-----------------------------|----------------|-----------------|
| LQW04CA_00 | p147 03019 (0805) | 60nH to 510nH | 200mA to 620mA |
| LQW15CA_00 | p148 0402 (1005) | 22nH to 2000nH | 130mA to 1300mA |
| LQW18CA_00 | p150 0603 (1608) | 32nH to 580nH | 450mA to 2200mA |

NFE

Feed-Through Chip EMI Filters

| Part Number | Size Code in inches (mm) | Capacitance | Rated Current |
|-----------------------------|-----------------------------|----------------|---------------|
| NFE31PT <small>p172</small> | 1206 (3216) | 22pF to 2200pF | 6A |
| NFE61PT <small>p173</small> | 2706 (6816) | 33pF to 4700pF | 2A |

NFL/NFA/NFW

LC Combined Chip EMI Filters

| Part Number | Size Code in inches (mm) | Nominal Cut-off Frequency | Rated Current |
|--|-----------------------------|---------------------------|----------------|
| NFL18ST <small>p174</small> | 0603 (1608) | 50MHz to 500MHz | 75mA to 200mA |
| NFL18SP <small>p176</small> | 0603 (1608) | 150MHz to 500MHz | 100mA |
| NFL21SP <small>p177</small> | 0805 (2012) | 10MHz to 500MHz | 100mA to 300mA |
| NFA18SL (4 circuits array) <small>p178</small> | 0603 (1608) | 50MHz to 480MHz | 25mA to 100mA |
| NFA18SD (4 circuits array) <small>p181</small> | 0603 (1608) | 180MHz to 200MHz | 25mA |
| NFA21SL (4 circuits array) <small>p182</small> | 0805 (2012) | 50MHz to 330MHz | 20mA to 100mA |
| NFW31SP <small>p184</small> | 1206 (3216) | 10MHz to 500MHz | 200mA |

DLM/DLP/DLW/NFP

Common Mode Choke Coil/Common Mode Noise Filter

| Part Number | Size Code in inches (mm) | Common Mode Impedance (at 100MHz) | Rated Current |
|--|-----------------------------|--------------------------------------|----------------|
| DLM0QS (Limited for differential signal interface line) <small>p202</small> | 025020(0605) | 12Ω to 90Ω | 50mA to 150mA |
| DLM0NS (Limited for differential signal interface line) <small>p203</small> | 03025(0806) | 12Ω to 90Ω | 100mA to 160mA |
| DLM11G <small>p205</small> | 0504(1210) | 600Ω | 100mA |
| DLM11S <small>p206</small> | 0504(1210) | 45Ω to 90Ω | 100mA |
| DLP0QS <small>p207</small> | 025020(0605) | 7Ω to 35Ω | 100mA |
| DLP0NS <small>p208</small> | 03025(0806) | 7Ω to 120Ω | 75mA to 110mA |
| DLP11R <small>p210</small> | 0504(1210) | 15Ω to 45Ω | 100mA |
| DLP11S <small>p212</small> | 0504(1210) | 35Ω to 330Ω | 80mA to 180mA |
| DLP11T <small>p214</small> | 0504(1210) | 80Ω | 100mA |
| DLP31S <small>p215</small> | 1206(3216) | 120Ω to 550Ω | 100mA |
| DLP1ND (2 circuits array) <small>p216</small> | 05025(1506) | 35Ω to 90Ω | 60mA to 100mA |
| DLP2AD (2 circuits array) <small>p217</small> | 0804(2010) | 35Ω to 280Ω | 80mA to 150mA |
| DLP31D (2 circuits array) <small>p219</small> | 1206(3216) | 90Ω to 440Ω | 70mA to 160mA |
| DLW21H <small>p220</small> | 0805(2012) | 67Ω to 180Ω | 200mA to 330mA |
| DLW21S <small>p222</small> | 0805(2012) | 67Ω to 920Ω | 160mA to 400mA |
| DLW31S <small>p225</small> | 1206(3216) | 90Ω to 2200Ω | 200mA to 370mA |
| NFP0Q <small>p226</small> | 025020(0605) | 90Ω | 100mA |
| DLW44S* <small>p228</small> | 1515(4040) | 100Ω to 2400Ω | 1.1A to 3.1A |
| DLW5AH_SQ2/DLW5BS_SQ2* <small>p229</small> | 2014(5036)/2020(5050) | 190Ω to 4000Ω | 200mA to 5A |
| DLW5AT_SQ2* <small>p231</small> | 2014(5036) | 110Ω to 2700Ω | 1A to 5A |
| DLW5AT_MQ2* <small>p233</small> | 2014(5036) | 50Ω to 1100Ω | 2A to 6A |
| DLW5AT_TQ2* <small>p234</small> | 2014(5036) | 110Ω to 500Ω | 2A to 5A |
| DLW5BS_TQ2* <small>p235</small> | 2020(5050) | 500Ω to 800Ω | 1A to 2A |
| DLW5BT_SQ2* <small>p236</small> | 2020(5050) | 100Ω to 1400Ω | 1.5A to 6A |
| DLW5BT_TQ2* <small>p237</small> | 2020(5050) | 100Ω to 1400Ω | 2A to 6A |

* The derating of rated current is required for some items according to the operating temperature on each product page.

PL□

Large Current Common Mode Choke Coil for Automotive Available

| Part Number | Size Code in inches (mm) | Common Mode Impedance (at 10MHz) | Rated Current |
|-------------------------------------|-----------------------------|-------------------------------------|---------------|
| PLT5BPH* <small>p238</small> | 2020(5050) | 100Ω to 500Ω | 3.1A to 5.6A |
| PLT10HH* <small>p239</small> | (12.9×6.6) | 45Ω to 1000Ω | 6A to 18A |

* The derating of rated current is required for some items according to the operating temperature on each product page.

BNX

Block Type EMIFIL®

| | Part Number | Rated Voltage | Rated Current |
|-----------|------------------------------------|------------------|---------------|
| SMD Type | BNX02□* <small>p256</small> | 6.3Vdc to 100Vdc | 20A |
| Lead Type | BNX01□* <small>p258</small> | 25Vdc to 50Vdc | 15A |

* The derating of rated current is required for some items according to the operating temperature on each product page.

Chip Ferrite Bead BLM/BLA/BLT Series

| | |
|------------------------------|------|
| Series Introduction | p16 |
| Part Numbering | p18 |
| Series Lineup | p19 |
| Product Detail | p26 |
| ⚠Caution/Notice | p110 |
| Soldering and Mounting | p111 |
| Packaging | p115 |

Chip Ferrite Bead (BL□) Series Introduction

● Example of Chip Ferrite Bead BLM Series Structure

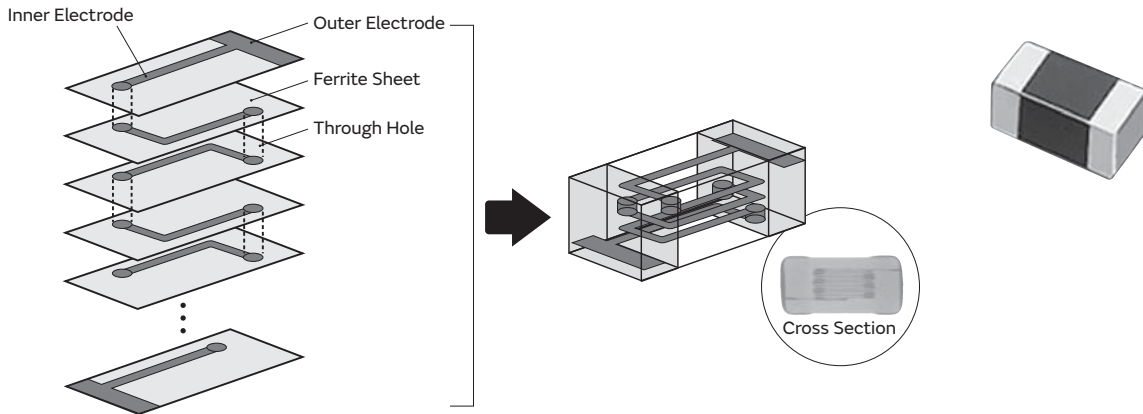

● Lineup Classification of Chip Ferrite Bead

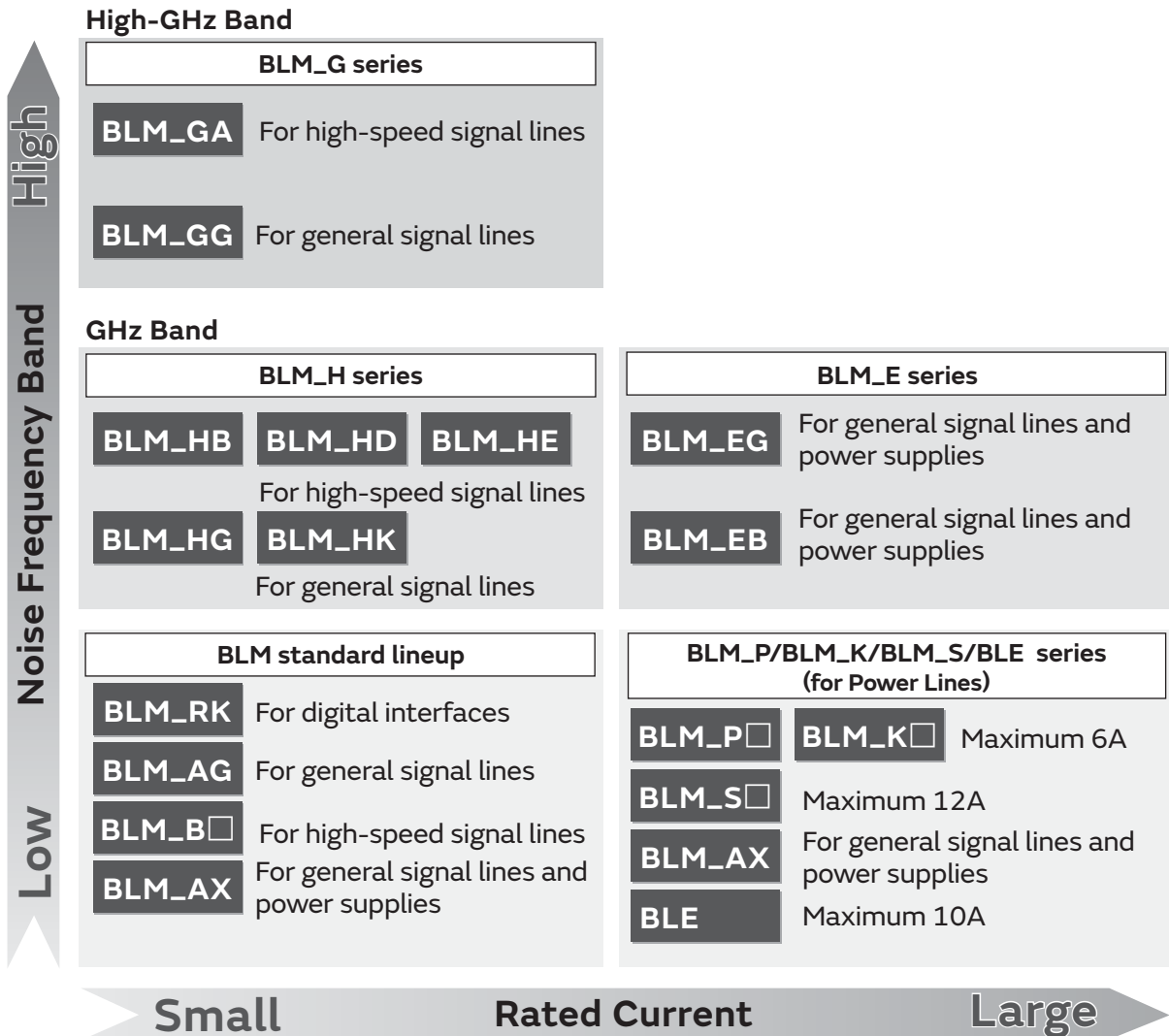

Chip Ferrite Bead (BL□) Series Introduction

●Difference between BLM A type and B type (HG type vs HD/HB/HE type)

A type: Impedance curve rises from low frequency range. Suppresses noise in a wide frequency range.
 B type: Impedance curve rises sharply. Less damage to signal waveforms.

Comparison of Impedance Curve

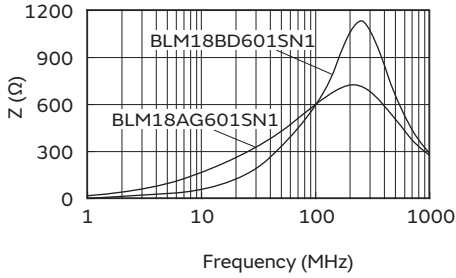

Comparison of Resistance Element

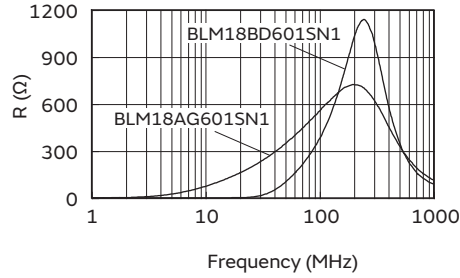

Comparison of Test Effect (25MHz)

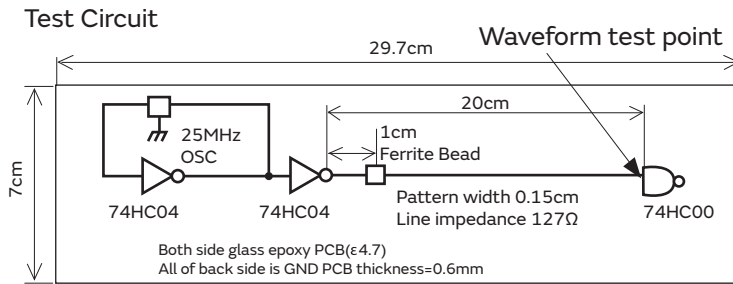

BLM_B Series has less damage to high-speed signal waveform.

Waveform

No filter

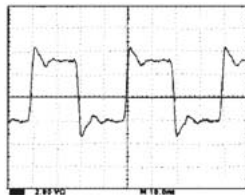

BLM18AG601SN1

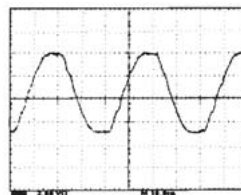

BLM18BD601SN1

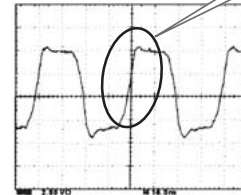

Small Distortion

Spectrum

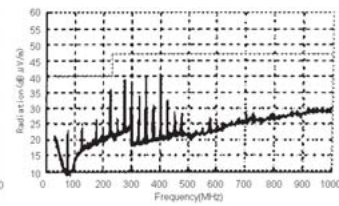
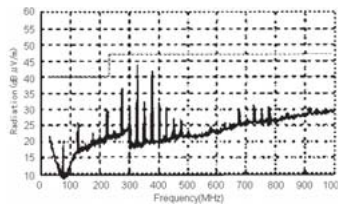
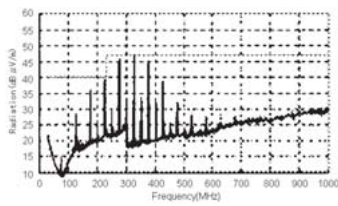

Spectrum has been reduced from low frequency range.

Noise frequency has been reduced without reducing signals of low frequency.

● Part Numbering

Chip Ferrite Bead

(Part Number)



① Product ID

| Product ID | |
|------------|--------------------|
| BL | Chip Ferrite Beads |

② Type

| Code | Type |
|------|--------------------------|
| A | Array Type |
| M | Ferrite Bead Single Type |
| T | Assembly Type |

④ Characteristics/Applications

| Code *1 | Characteristics/Applications |
|---------|--|
| AG | For General Use |
| AX | |
| TG | |
| BA | For High-speed Signal Lines |
| BB | |
| BC | |
| BD | |
| BX | |
| KD | |
| KG | For Power Lines |
| KN | |
| KX | |
| PD | |
| PG | |
| PX | |
| PT | |
| SD | |
| SG | |
| SN | |
| SP | |
| RK | For Digital Interface |
| HG | For GHz Band General Use |
| EB | For GHz Band High-speed Signal Lines (Low Direct Current Type) |
| EG | For GHz Band General Use (Low DC Resistance Type) |
| EX | |
| HB | For GHz Band High-speed Signal Lines |
| HD | |
| HE | |
| HK | For GHz Band Digital Interface |
| GA | For High-GHz Band High-speed Signal Lines |
| GG | For High-GHz Band General Use |

*1 Frequency characteristics vary with each code.

③ Dimensions (LxW)

| Code | Dimensions (LxW) | Size Code (inch) |
|------|------------------|------------------|
| 02 | 0.4x0.2mm | 01005 |
| 03 | 0.6x0.3mm | 0201 |
| 15 | 1.0x0.5mm | 0402 |
| 18 | 1.6x0.8mm | 0603 |
| 2A | 2.0x1.0mm | 0804 |
| 21 | 2.0x1.25mm | 0805 |
| 31 | 3.2x1.6mm | 1206 |
| 41 | 4.5x1.6mm | 1806 |
| 5B | 5.0x5.0mm | 2020 |

⑤ Impedance

Expressed by three figures. The unit is in ohm (Ω) at 100MHz. The first and second figures are significant digits, and the third figure expresses the number of zeros that follow the two figures.

⑥ Electrode

Expressed by a letter.

Ex.)

| Code | Electrode |
|-------|--------------------------|
| S/F/T | Sn Plating |
| A | Au Plating |
| L | Lead-Free Solder Plating |

⑦ Category

| Code | Category |
|------|---------------------|
| N | For General-Purpose |

⑧ Number of Circuits

| Code | Number of Circuits |
|------|--------------------|
| 1 | 1 Circuit |
| 4 | 4 Circuits |

⑨ Packaging

| Code | Packaging |
|------|--------------------------------------|
| K | Embossed Taping (ϕ 330mm Reel) |
| L | Embossed Taping (ϕ 180mm Reel) |
| B | Bulk |
| J | Paper Taping (ϕ 330mm Reel) |
| D | Paper Taping (ϕ 180mm Reel) |

Series Lineup

BLM/BLA/BLT

Chip Ferrite Bead

| Type | Size Code in inches (mm) | Thickness (mm) | Part Number | Impedance | | Rated Current | |
|--|------------------------------|------------------------------|------------------------------|------------------------------|----------|------------------|-------|
| | | | | at 100MHz | at 1GHz | | |
| For Power Lines | 01005 (0402) | 0.2 | BLM02PX100SN1 ^{p26} | 10Ω±5Ω | - | 1.1A | |
| | | 0.2 | BLM02PX220SN1 ^{p26} | 22Ω±25% | - | 750mA | |
| | | 0.2 | BLM02PX330SN1 ^{p26} | 33Ω±25% | - | 550mA | |
| | | 0.2 | BLM02PX600SN1 ^{p26} | 60Ω±25% | - | 500mA | |
| | | 0.3 | BLM02KX100SN1 ^{p28} | 10Ω±5Ω | - | 1.5A | |
| | | 0.3 | BLM02KX180SN1 ^{p28} | 18Ω±25% | - | 1.2A | |
| Universal Type [Power Lines/Signal Lines] | | 0.2 | BLM02AX100SN1 ^{p29} | 10Ω±5Ω | - | 750mA | |
| | | 0.2 | BLM02AX700SN1 ^{p29} | 70Ω±25% | - | 300mA | |
| | | 0.2 | BLM02AX121SN1 ^{p29} | 120Ω±25% | - | 250mA | |
| For High-Speed Signal Lines | | 0.2 | BLM02AX241SN1 ^{p29} | 240Ω±25% | - | 200mA | |
| | | 0.2 | BLM02BB101SN1 ^{p31} | 100Ω±25% | - | 125mA | |
| | | 0.2 | BLM02BC100SN1 ^{p31} | 10Ω±5Ω | 95Ω±50% | 250mA | |
| | | 0.2 | BLM02BC220SN1 ^{p31} | 22Ω±25% | 240Ω±40% | 200mA | |
| | | 0.2 | BLM02BX121SN1 ^{p32} | 120Ω±25% | - | 350mA | |
| | | 0.2 | BLM02BX151SN1 ^{p32} | 150Ω±25% | - | 280mA | |
| For Power Lines | | 0.2 | BLM02BX241SN1 ^{p32} | 240Ω±25% | - | 240mA | |
| | | 0201 (0603) | 0.3 | BLM03PG220SN1 ^{p33} | 22Ω±25% | - | 900mA |
| | | | 0.3 | BLM03PG330SN1 ^{p33} | 33Ω±25% | - | 750mA |
| | 0.3 | | BLM03PX220SN1 ^{p34} | 22Ω±25% | - | 1.8A | |
| | 0.3 | | BLM03PX330SN1 ^{p34} | 33Ω±25% | - | 1.5A | |
| | 0.3 | | BLM03PX800SN1 ^{p34} | 80Ω±25% | - | 1A | |
| 0.3 | BLM03PX121SN1 ^{p34} | | 120Ω±25% | - | 900mA | | |
| For General Signal Lines | 0.3 | BLM03AG100SN1 ^{p36} | 10Ω (Typ.) | - | 500mA | | |
| | 0.3 | BLM03AG700SN1 ^{p36} | 70Ω (Typ.) | - | 200mA | | |
| | 0.3 | BLM03AG800SN1 ^{p36} | 80Ω±25% | - | 200mA | | |
| | 0.3 | BLM03AG121SN1 ^{p36} | 120Ω±25% | - | 200mA | | |
| | 0.3 | BLM03AG241SN1 ^{p36} | 240Ω±25% | - | 200mA | | |
| | 0.3 | BLM03AG601SN1 ^{p36} | 600Ω±25% | - | 100mA | | |
| Universal Type [Power Lines/Signal Lines] | 0.3 | BLM03AG102SN1 ^{p36} | 1000Ω±25% | - | 100mA | | |
| | 0.3 | BLM03AX100SN1 ^{p38} | 10Ω (Typ.) | - | 1A | | |
| | 0.3 | BLM03AX800SN1 ^{p38} | 80Ω±25% | - | 500mA | | |
| | 0.3 | BLM03AX121SN1 ^{p38} | 120Ω±25% | - | 450mA | | |
| | 0.3 | BLM03AX241SN1 ^{p38} | 240Ω±25% | - | 350mA | | |
| | 0.3 | BLM03AX601SN1 ^{p38} | 600Ω±25% | - | 250mA | | |
| For High-Speed Signal Lines (Sharp Impedance Curve) | 0.3 | BLM03AX102SN1 ^{p38} | 1000Ω±25% | - | 200mA | | |
| | 0.3 | BLM03BB100SN1 ^{p39} | 10Ω±25% | - | 300mA | | |
| | 0.3 | BLM03BB220SN1 ^{p39} | 22Ω±25% | - | 200mA | | |
| | 0.3 | BLM03BB470SN1 ^{p39} | 47Ω±25% | - | 200mA | | |
| | 0.3 | BLM03BB750SN1 ^{p39} | 75Ω±25% | - | 200mA | | |
| | 0.3 | BLM03BB121SN1 ^{p39} | 120Ω±25% | - | 100mA | | |
| | 0.3 | BLM03BC330SN1 ^{p39} | 33Ω±25% | - | 150mA | | |
| | 0.3 | BLM03BC560SN1 ^{p39} | 56Ω±25% | - | 100mA | | |
| | 0.3 | BLM03BC800SN1 ^{p39} | 80Ω±25% | - | 100mA | | |
| | 0.3 | BLM03BD750SN1 ^{p39} | 75Ω±25% | - | 300mA | | |
| | 0.3 | BLM03BD121SN1 ^{p39} | 120Ω±25% | - | 250mA | | |
| | 0.3 | BLM03BD241SN1 ^{p39} | 240Ω±25% | - | 200mA | | |
| | 0.3 | BLM03BD471SN1 ^{p39} | 470Ω±25% | - | 215mA | | |
| | 0.3 | BLM03BD601SN1 ^{p39} | 600Ω±25% | - | 200mA | | |
| | 0.3 | BLM03BX102SN1 ^{p41} | 1000Ω±25% | - | 170mA | | |
| 0.3 | BLM03BX182SN1 ^{p41} | 1800Ω±25% | - | 140mA | | | |

Continued on the following page. ↗

Chip Ferrite Bead

Application Specified Noise Filter

Chip EMIFIL®

Common Mode Choke Coil
 Common Mode Noise Filter

Block Type EMIFIL®

EMC Absorber

| Type | Size Code in inches (mm) | Thickness (mm) | Part Number | Impedance | | Rated Current |
|--|------------------------------|--------------------------|------------------------------|------------|------------------------------|------------------|
| | | | | at 100MHz | at 1GHz | |
| For Power Lines | 0402 (1005) | 0.5 | BLM15PD300SN1 ^{p42} | 30Ω±25% | - | 2.2A |
| | | 0.5 | BLM15PD600SN1 ^{p42} | 60Ω±25% | - | 1.7A |
| | | 0.5 | BLM15PD800SN1 ^{p42} | 80Ω±25% | - | 1.5A |
| | | 0.5 | BLM15PD121SN1 ^{p42} | 120Ω±25% | - | 1.3A |
| | | 0.5 | BLM15PG100SN1 ^{p42} | 10Ω (Typ.) | - | 1A |
| | | 0.5 | BLM15PX330SN1 ^{p44} | 33Ω±25% | - | 3A |
| | | 0.5 | BLM15PX600SN1 ^{p44} | 60Ω±25% | - | 2.5A |
| | | 0.5 | BLM15PX800SN1 ^{p44} | 80Ω±25% | - | 2.3A |
| | | 0.5 | BLM15PX121SN1 ^{p44} | 120Ω±25% | - | 2A |
| | | 0.5 | BLM15PX181SN1 ^{p44} | 180Ω±25% | - | 1.5A |
| | | 0.5 | BLM15PX221SN1 ^{p44} | 220Ω±25% | - | 1.4A |
| | | 0.5 | BLM15PX331SN1 ^{p44} | 330Ω±25% | - | 1.2A |
| | | 0.5 | BLM15PX471SN1 ^{p44} | 470Ω±25% | - | 1A |
| | | 0.5 | BLM15PX601SN1 ^{p44} | 600Ω±25% | - | 900mA |
| | | For General Signal Lines | 0402 (1005) | 0.5 | BLM15KD200SN1 ^{p46} | 20Ω±25% |
| 0.5 | BLM15KD300SN1 ^{p46} | | | 30Ω±25% | - | 3.1A |
| 0.5 | BLM15KD121SN1 ^{p46} | | | 120Ω±25% | - | 1.5A |
| 0.5 | BLM15AG100SN1 ^{p47} | | | 10Ω (Typ.) | - | 1A |
| 0.5 | BLM15AG700SN1 ^{p47} | | | 70Ω (Typ.) | - | 600mA |
| 0.5 | BLM15AG121SN1 ^{p47} | | | 120Ω±25% | - | 550mA |
| Universal Type [Power Lines/Signal Lines] | 0402 (1005) | 0.5 | BLM15AG221SN1 ^{p47} | 220Ω±25% | - | 450mA |
| | | 0.5 | BLM15AG601SN1 ^{p47} | 600Ω±25% | - | 300mA |
| | | 0.5 | BLM15AG102SN1 ^{p47} | 1000Ω±25% | - | 300mA |
| | | 0.5 | BLM15AX100SN1 ^{p48} | 10Ω±5Ω | - | 1.74A |
| | | 0.5 | BLM15AX300SN1 ^{p48} | 30Ω±25% | - | 1.1A |
| | | 0.5 | BLM15AX700SN1 ^{p48} | 70Ω±25% | - | 780mA |
| | | 0.5 | BLM15AX121SN1 ^{p48} | 120Ω±25% | - | 700mA |
| | | 0.5 | BLM15AX221SN1 ^{p48} | 220Ω±25% | - | 600mA |
| For High-Speed Signal Lines (Sharp Impedance Curve) | 0402 (1005) | 0.5 | BLM15AX601SN1 ^{p48} | 600Ω±25% | - | 500mA |
| | | 0.5 | BLM15AX102SN1 ^{p48} | 1000Ω±25% | - | 350mA |
| | | 0.5 | BLM15BA050SN1 ^{p50} | 5Ω±25% | - | 300mA |
| | | 0.5 | BLM15BA100SN1 ^{p50} | 10Ω±25% | - | 300mA |
| | | 0.5 | BLM15BA220SN1 ^{p50} | 22Ω±25% | - | 300mA |
| | | 0.5 | BLM15BA330SN1 ^{p50} | 33Ω±25% | - | 300mA |
| | | 0.5 | BLM15BA470SN1 ^{p50} | 47Ω±25% | - | 200mA |
| | | 0.5 | BLM15BA750SN1 ^{p50} | 75Ω±25% | - | 200mA |
| | | 0.5 | BLM15BB050SN1 ^{p50} | 5Ω±25% | - | 500mA |
| | | 0.5 | BLM15BB100SN1 ^{p50} | 10Ω±25% | - | 300mA |
| | | 0.5 | BLM15BB220SN1 ^{p50} | 22Ω±25% | - | 300mA |
| | | 0.5 | BLM15BB470SN1 ^{p50} | 47Ω±25% | - | 300mA |
| | | 0.5 | BLM15BB750SN1 ^{p50} | 75Ω±25% | - | 300mA |
| | | 0.5 | BLM15BB121SN1 ^{p50} | 120Ω±25% | - | 300mA |
| | | 0.5 | BLM15BB221SN1 ^{p50} | 220Ω±25% | - | 200mA |
| | | 0.5 | BLM15BC121SN1 ^{p50} | 120Ω±25% | - | 350mA |
| | | 0.5 | BLM15BC241SN1 ^{p50} | 240Ω±25% | - | 250mA |
| | | 0.5 | BLM15BD750SN1 ^{p50} | 75Ω±25% | - | 300mA |
| | | 0.5 | BLM15BD121SN1 ^{p50} | 120Ω±25% | - | 300mA |
| | | 0.5 | BLM15BD221SN1 ^{p50} | 220Ω±25% | - | 300mA |
| 0.5 | BLM15BD471SN1 ^{p50} | 470Ω±25% | - | 200mA | | |
| 0.5 | BLM15BD601SN1 ^{p50} | 600Ω±25% | - | 200mA | | |
| 0.5 | BLM15BD102SN1 ^{p50} | 1000Ω±25% | - | 200mA | | |

Continued on the following page. ↗

| Type | Size Code in inches (mm) | Thickness (mm) | Part Number | Impedance | | Rated Current |
|---|--------------------------|----------------|------------------------------|------------|---------|---------------|
| | | | | at 100MHz | at 1GHz | |
| For High-Speed Signal Lines (Sharp Impedance Curve) | 0402 (1005) | 0.5 | BLM15BD152SN1 ^{p50} | 1500Ω±25% | - | 190mA |
| | | 0.5 | BLM15BD182SN1 ^{p50} | 1800Ω±25% | - | 100mA |
| | | 0.5 | BLM15BX750SN1 ^{p53} | 75Ω±25% | - | 600mA |
| | | 0.5 | BLM15BX121SN1 ^{p53} | 120Ω±25% | - | 600mA |
| | | 0.5 | BLM15BX221SN1 ^{p53} | 220Ω±25% | - | 450mA |
| | | 0.5 | BLM15BX471SN1 ^{p53} | 470Ω±25% | - | 350mA |
| | | 0.5 | BLM15BX601SN1 ^{p53} | 600Ω±25% | - | 350mA |
| | | 0.5 | BLM15BX102SN1 ^{p53} | 1000Ω±25% | - | 300mA |
| For Power Lines Standard Type | 0603 (1608) | 0.8 | BLM18PG300SN1 ^{p55} | 30Ω (Typ.) | - | 1A |
| | | 0.8 | BLM18PG330SN1 ^{p55} | 33Ω±25% | - | 3A |
| | | 0.8 | BLM18PG600SN1 ^{p55} | 60Ω (Typ.) | - | 1A |
| | | 0.8 | BLM18PG121SN1 ^{p55} | 120Ω±25% | - | 2A |
| | | 0.8 | BLM18PG181SN1 ^{p55} | 180Ω±25% | - | 1.5A |
| | | 0.8 | BLM18PG221SN1 ^{p55} | 220Ω±25% | - | 1.4A |
| | | 0.8 | BLM18PG331SN1 ^{p55} | 330Ω±25% | - | 1.2A |
| | | 0.8 | BLM18PG471SN1 ^{p55} | 470Ω±25% | - | 1A |
| For Power Lines Low DC Resistance Type | 0603 (1608) | 0.8 | BLM18KG221SN1 ^{p57} | 220Ω±25% | - | 2.2A |
| | | 0.8 | BLM18KG331SN1 ^{p57} | 330Ω±25% | - | 1.7A |
| | | 0.8 | BLM18KG471SN1 ^{p57} | 470Ω±25% | - | 1.5A |
| | | 0.8 | BLM18KG601SN1 ^{p57} | 600Ω±25% | - | 1.3A |
| | | 0.8 | BLM18KG102SN1 ^{p57} | 1000Ω±25% | - | 1A |
| | | 0.6 | BLM18KG260TN1 ^{p57} | 26Ω±25% | - | 6A |
| | | 0.6 | BLM18KG300TN1 ^{p57} | 30Ω±25% | - | 5A |
| | | 0.6 | BLM18KG700TN1 ^{p57} | 70Ω±25% | - | 3.5A |
| | | 0.6 | BLM18KG101TN1 ^{p57} | 100Ω±25% | - | 3A |
| | | 0.6 | BLM18KG121TN1 ^{p57} | 120Ω±25% | - | 3A |
| | | 0.8 | BLM18SD220SN1 ^{p59} | 22Ω±25% | - | 6A |
| | | 0.8 | BLM18SG330SN1 ^{p59} | 33Ω±25% | - | 6A |
| | | 0.5 | BLM18SG260TN1 ^{p59} | 26Ω±25% | - | 6A |
| | | 0.5 | BLM18SG700TN1 ^{p59} | 70Ω±25% | - | 4A |
| For General Signal Lines | 0603 (1608) | 0.5 | BLM18SG121TN1 ^{p59} | 120Ω±25% | - | 3A |
| | | 0.5 | BLM18SG221TN1 ^{p60} | 220Ω±25% | - | 2.5A |
| | | 0.5 | BLM18SG331TN1 ^{p60} | 330Ω±25% | - | 1.5A |
| | | 0.6 | BLM18SN220TN1 ^{p60} | 22Ω±7Ω | - | 8A |
| | | 0.8 | BLM18AG121SN1 ^{p62} | 120Ω±25% | - | 800mA |
| | | 0.8 | BLM18AG151SN1 ^{p62} | 150Ω±25% | - | 700mA |
| | | 0.8 | BLM18AG221SN1 ^{p62} | 220Ω±25% | - | 700mA |
| | | 0.8 | BLM18AG331SN1 ^{p62} | 330Ω±25% | - | 600mA |
| | | 0.8 | BLM18AG471SN1 ^{p62} | 470Ω±25% | - | 550mA |
| | | 0.8 | BLM18AG601SN1 ^{p62} | 600Ω±25% | - | 500mA |
| For High-Speed Signal Lines (Sharp Impedance Curve) | 0603 (1608) | 0.8 | BLM18AG102SN1 ^{p62} | 1000Ω±25% | - | 450mA |
| | | 0.6 | BLM18TG121TN1 ^{p64} | 120Ω±25% | - | 200mA |
| | | 0.6 | BLM18TG221TN1 ^{p64} | 220Ω±25% | - | 200mA |
| | | 0.6 | BLM18TG601TN1 ^{p64} | 600Ω±25% | - | 200mA |
| | | 0.6 | BLM18TG102TN1 ^{p64} | 1000Ω±25% | - | 100mA |
| | | 0.8 | BLM18BA050SN1 ^{p65} | 5Ω±25% | - | 500mA |
| For High-Speed Signal Lines (Sharp Impedance Curve) | 0603 (1608) | 0.8 | BLM18BA100SN1 ^{p65} | 10Ω±25% | - | 500mA |
| | | 0.8 | BLM18BA220SN1 ^{p65} | 22Ω±25% | - | 500mA |
| | | 0.8 | BLM18BA470SN1 ^{p65} | 47Ω±25% | - | 300mA |
| | | 0.8 | BLM18BA750SN1 ^{p65} | 75Ω±25% | - | 300mA |

Continued on the following page. ↗

| Type | Size Code in inches (mm) | Thickness (mm) | Part Number | Impedance | | Rated Current |
|---|------------------------------|--------------------------|------------------------------|------------|------------------------------|---------------|
| | | | | at 100MHz | at 1GHz | |
| For High-Speed Signal Lines (Sharp Impedance Curve) | 0603 (1608) | 0.8 | BLM18BA121SN1 ^{p65} | 120Ω±25% | - | 200mA |
| | | 0.8 | BLM18BB050SN1 ^{p65} | 5Ω±25% | - | 800mA |
| | | 0.8 | BLM18BB100SN1 ^{p65} | 10Ω±25% | - | 700mA |
| | | 0.8 | BLM18BB220SN1 ^{p65} | 22Ω±25% | - | 700mA |
| | | 0.8 | BLM18BB470SN1 ^{p65} | 47Ω±25% | - | 600mA |
| | | 0.8 | BLM18BB600SN1 ^{p65} | 60Ω±25% | - | 600mA |
| | | 0.8 | BLM18BB750SN1 ^{p65} | 75Ω±25% | - | 600mA |
| | | 0.8 | BLM18BB121SN1 ^{p65} | 120Ω±25% | - | 550mA |
| | | 0.8 | BLM18BB141SN1 ^{p65} | 140Ω±25% | - | 500mA |
| | | 0.8 | BLM18BB151SN1 ^{p65} | 150Ω±25% | - | 450mA |
| | | 0.8 | BLM18BB221SN1 ^{p65} | 220Ω±25% | - | 450mA |
| | | 0.8 | BLM18BB331SN1 ^{p65} | 330Ω±25% | - | 400mA |
| | | 0.8 | BLM18BB471SN1 ^{p65} | 470Ω±25% | - | 300mA |
| | | 0.8 | BLM18BD470SN1 ^{p65} | 47Ω±25% | - | 500mA |
| | | 0.8 | BLM18BD121SN1 ^{p65} | 120Ω±25% | - | 300mA |
| | | 0.8 | BLM18BD151SN1 ^{p65} | 150Ω±25% | - | 300mA |
| | | 0.8 | BLM18BD221SN1 ^{p65} | 220Ω±25% | - | 250mA |
| | | 0.8 | BLM18BD331SN1 ^{p65} | 330Ω±25% | - | 250mA |
| | | 0.8 | BLM18BD421SN1 ^{p65} | 420Ω±25% | - | 250mA |
| | | 0.8 | BLM18BD471SN1 ^{p65} | 470Ω±25% | - | 250mA |
| | | 0.8 | BLM18BD601SN1 ^{p65} | 600Ω±25% | - | 200mA |
| | | 0.8 | BLM18BD102SN1 ^{p65} | 1000Ω±25% | - | 200mA |
| | | 0.8 | BLM18BD152SN1 ^{p65} | 1500Ω±25% | - | 150mA |
| | | 0.8 | BLM18BD182SN1 ^{p65} | 1800Ω±25% | - | 150mA |
| 0.8 | BLM18BD222SN1 ^{p65} | 2200Ω±25% | - | 150mA | | |
| 0.8 | BLM18BD252SN1 ^{p65} | 2500Ω±25% | - | 150mA | | |
| For Digital Interface Lines | | 0.8 | BLM18RK121SN1 ^{p69} | 120Ω±25% | - | 200mA |
| | | 0.8 | BLM18RK221SN1 ^{p69} | 220Ω±25% | - | 200mA |
| | | 0.8 | BLM18RK471SN1 ^{p69} | 470Ω±25% | - | 200mA |
| | | 0.8 | BLM18RK601SN1 ^{p69} | 600Ω±25% | - | 200mA |
| | | 0.8 | BLM18RK102SN1 ^{p69} | 1000Ω±25% | - | 200mA |
| For Power Lines | 0805 (2012) | 0.85 | BLM21PG220SN1 ^{p71} | 22Ω±25% | - | 6A |
| | | 0.85 | BLM21PG300SN1 ^{p71} | 30Ω (Typ.) | - | 4A |
| | | 0.85 | BLM21PG600SN1 ^{p71} | 60Ω±25% | - | 3.5A |
| | | 0.85 | BLM21PG121SN1 ^{p71} | 120Ω±25% | - | 3A |
| | | 0.85 | BLM21PG221SN1 ^{p71} | 220Ω±25% | - | 2A |
| | | 0.85 | BLM21PG331SN1 ^{p71} | 330Ω±25% | - | 1.5A |
| | | 0.85 | BLM21SN300SN1 ^{p73} | 30Ω±10Ω | - | 8.5A |
| | | 0.85 | BLM21SP700SN1 ^{p73} | 70Ω±25% | - | 6A |
| | | 0.85 | BLM21SP111SN1 ^{p73} | 110Ω±25% | - | 5A |
| | | 0.85 | BLM21SP181SN1 ^{p73} | 180Ω±25% | - | 4A |
| | | 0.85 | BLM21SP331SN1 ^{p73} | 330Ω±25% | - | 2.8A |
| | | 0.85 | BLM21SP471SN1 ^{p73} | 470Ω±25% | - | 2.5A |
| | | 0.85 | BLM21SP601SN1 ^{p73} | 600Ω±25% | - | 2.3A |
| | | 0.85 | BLM21SP102SN1 ^{p73} | 1000Ω±25% | - | 1.6A |
| | | For General Signal Lines | | 0.85 | BLM21AG121SN1 ^{p75} | 120Ω±25% |
| 0.85 | BLM21AG151SN1 ^{p75} | | | 150Ω±25% | - | 1A |
| 0.85 | BLM21AG221SN1 ^{p75} | | | 220Ω±25% | - | 900mA |
| 0.85 | BLM21AG331SN1 ^{p75} | | | 330Ω±25% | - | 800mA |
| 0.85 | BLM21AG471SN1 ^{p75} | | | 470Ω±25% | - | 700mA |
| 0.85 | BLM21AG601SN1 ^{p75} | 600Ω±25% | - | 700mA | | |

Continued on the following page. ↗

| Type | Size Code in inches (mm) | Thickness (mm) | Part Number | Impedance | | Rated Current | | |
|---|-------------------------------------|-------------------------------------|-------------------------------------|------------|-------------------------------------|---------------|---|-------|
| | | | | at 100MHz | at 1GHz | | | |
| For General Signal Lines | | 0.85 | BLM21AG102SN1 ^{p75} | 1000Ω±25% | - | 600mA | | |
| | | 0.85 | BLM21BB050SN1 ^{p77} | 5Ω±25% | - | 1A | | |
| For High-Speed Signal Lines (Sharp Impedance Curve) | 0805 (2012) | 0.85 | BLM21BB600SN1 ^{p77} | 60Ω±25% | - | 800mA | | |
| | | 0.85 | BLM21BB750SN1 ^{p77} | 75Ω±25% | - | 700mA | | |
| | | 0.85 | BLM21BB121SN1 ^{p77} | 120Ω±25% | - | 600mA | | |
| | | 0.85 | BLM21BB151SN1 ^{p77} | 150Ω±25% | - | 600mA | | |
| | | 0.85 | BLM21BB201SN1 ^{p77} | 200Ω±25% | - | 500mA | | |
| | | 0.85 | BLM21BB221SN1 ^{p77} | 220Ω±25% | - | 500mA | | |
| | | 0.85 | BLM21BB331SN1 ^{p77} | 330Ω±25% | - | 400mA | | |
| | | 0.85 | BLM21BB471SN1 ^{p77} | 470Ω±25% | - | 400mA | | |
| | | 0.85 | BLM21BD121SN1 ^{p77} | 120Ω±25% | - | 350mA | | |
| | | 0.85 | BLM21BD151SN1 ^{p77} | 150Ω±25% | - | 350mA | | |
| | | 0.85 | BLM21BD221SN1 ^{p77} | 220Ω±25% | - | 350mA | | |
| | | 0.85 | BLM21BD331SN1 ^{p77} | 330Ω±25% | - | 300mA | | |
| | | 0.85 | BLM21BD421SN1 ^{p77} | 420Ω±25% | - | 300mA | | |
| | | 0.85 | BLM21BD471SN1 ^{p77} | 470Ω±25% | - | 300mA | | |
| | | 0.85 | BLM21BD601SN1 ^{p77} | 600Ω±25% | - | 300mA | | |
| | | 0.85 | BLM21BD751SN1 ^{p77} | 750Ω±25% | - | 250mA | | |
| | | 0.85 | BLM21BD102SN1 ^{p77} | 1000Ω±25% | - | 250mA | | |
| | | 0.85 | BLM21BD152SN1 ^{p77} | 1500Ω±25% | - | 250mA | | |
| | | 0.85 | BLM21BD182SN1 ^{p77} | 1800Ω±25% | - | 250mA | | |
| | | For Digital Interface Lines | | 1.25 | BLM21BD222SN1 ^{p77} | 2250Ω (Typ.) | - | 250mA |
| 1.25 | BLM21BD272SN1 ^{p77} | | | 2700Ω±25% | - | 200mA | | |
| 0.85 | BLM21BD222TN1 ^{p77} | | | 2200Ω±25% | - | 200mA | | |
| 0.85 | BLM21RK121SN1 ^{p80} | | | 120Ω±25% | - | 200mA | | |
| 0.85 | BLM21RK221SN1 ^{p80} | | | 220Ω±25% | - | 200mA | | |
| 0.85 | BLM21RK471SN1 ^{p80} | | | 470Ω±25% | - | 200mA | | |
| 0.85 | BLM21RK601SN1 ^{p80} | | | 600Ω±25% | - | 200mA | | |
| 0.85 | BLM21RK102SN1 ^{p80} | | | 1000Ω±25% | - | 200mA | | |
| For Power Lines | 1206 (3216) | | | 1.6 | BLM31KN121SN1 ^{p81} | 120Ω±25% | - | 6A |
| | | | | 1.6 | BLM31KN271SN1 ^{p81} | 270Ω±25% | - | 4.5A |
| | | 1.6 | BLM31KN471SN1 ^{p81} | 470Ω±25% | - | 4A | | |
| | | 1.6 | BLM31KN601SN1 ^{p81} | 600Ω±25% | - | 2.9A | | |
| | | 1.6 | BLM31KN801SN1 ^{p81} | 800Ω±25% | - | 2.5A | | |
| | | 1.6 | BLM31KN102SN1 ^{p81} | 1000Ω±25% | - | 2A | | |
| | | 1.1 | BLM31PG330SN1 ^{p83} | 33Ω±25% | - | 6A | | |
| | | 1.1 | BLM31PG500SN1 ^{p83} | 50Ω (Typ.) | - | 3.5A | | |
| | | 1.1 | BLM31PG121SN1 ^{p83} | 120Ω±25% | - | 3.5A | | |
| | | 1.1 | BLM31PG391SN1 ^{p83} | 390Ω±25% | - | 2A | | |
| | 1.1 | BLM31PG601SN1 ^{p83} | 600Ω±25% | - | 1.5A | | | |
| | 1.1 | BLM31SN500SN1 ^{p85} | 50Ω±12.5Ω | - | 12A | | | |
| | 1806 (4516) | 1.6 | BLM41PG600SN1 ^{p86} | 60Ω (Typ.) | - | 6A | | |
| | | 1.6 | BLM41PG750SN1 ^{p86} | 75Ω (Typ.) | - | 3.5A | | |
| | | 1.6 | BLM41PG181SN1 ^{p86} | 180Ω±25% | - | 3.5A | | |
| 1.6 | | BLM41PG471SN1 ^{p86} | 470Ω±25% | - | 2A | | | |
| 1.6 | | BLM41PG102SN1 ^{p86} | 1000Ω±25% | - | 1.5A | | | |
| For Power Lines | 2020 (5050) | 5.0 | BLT5BPT680LN1 ^{p88} | 68Ω (Typ.) | - | 11A | | |
| For General Signal Lines | 0804 (2010) | 0.5 | BLA2AAG121SN4 ^{p89} | 120Ω±25% | - | 100mA | | |
| | | 0.5 | BLA2AAG221SN4 ^{p89} | 220Ω±25% | - | 50mA | | |
| | | 0.5 | BLA2AAG601SN4 ^{p89} | 600Ω±25% | - | 50mA | | |
| | | 0.5 | BLA2AAG102SN4 ^{p89} | 1000Ω±25% | - | 50mA | | |

Continued on the following page. ↗

Chip Ferrite Bead

Application Specified Noise Filter

Chip EMIFIL®

Common Mode Choke Coil
 Common Mode Noise Filter

Block Type EMIFIL®

EMC Absorber

| Type | Size Code in inches (mm) | Thickness (mm) | Part Number | Impedance | | Rated Current | |
|---|--|-------------------|-------------------------------|------------------------------|-------------|------------------|-------|
| | | | | at 100MHz | at 1GHz | | |
| For High-Speed Signal Lines | 0804 (2010) | 0.5 | BLA2ABB100SN4 ^{p90} | 10Ω±25% | - | 200mA | |
| | | 0.5 | BLA2ABB220SN4 ^{p90} | 22Ω±25% | - | 200mA | |
| | | 0.5 | BLA2ABB470SN4 ^{p90} | 47Ω±25% | - | 200mA | |
| | | 0.5 | BLA2ABB121SN4 ^{p90} | 120Ω±25% | - | 50mA | |
| | | 0.5 | BLA2ABB221SN4 ^{p90} | 220Ω±25% | - | 50mA | |
| | | 0.5 | BLA2ABD750SN4 ^{p90} | 75Ω±25% | - | 200mA | |
| | | 0.5 | BLA2ABD121SN4 ^{p90} | 120Ω±25% | - | 200mA | |
| | | 0.5 | BLA2ABD221SN4 ^{p90} | 220Ω±25% | - | 100mA | |
| | | 0.5 | BLA2ABD471SN4 ^{p90} | 470Ω±25% | - | 100mA | |
| | | 0.5 | BLA2ABD601SN4 ^{p90} | 600Ω±25% | - | 100mA | |
| For General Signal Lines | 1206 (3216) | 0.8 | BLA31AG300SN4 ^{p92} | 30Ω±25% | - | 200mA | |
| | | 0.8 | BLA31AG600SN4 ^{p92} | 60Ω±25% | - | 200mA | |
| | | 0.8 | BLA31AG121SN4 ^{p92} | 120Ω±25% | - | 150mA | |
| | | 0.8 | BLA31AG221SN4 ^{p92} | 220Ω±25% | - | 150mA | |
| | | 0.8 | BLA31AG601SN4 ^{p92} | 600Ω±25% | - | 100mA | |
| | | 0.8 | BLA31AG102SN4 ^{p92} | 1000Ω±25% | - | 50mA | |
| For High-Speed Signal Lines | | 0.8 | BLA31BD121SN4 ^{p93} | 120Ω±25% | - | 150mA | |
| | | 0.8 | BLA31BD221SN4 ^{p93} | 220Ω±25% | - | 150mA | |
| | | 0.8 | BLA31BD471SN4 ^{p93} | 470Ω±25% | - | 100mA | |
| | | 0.8 | BLA31BD601SN4 ^{p93} | 600Ω±25% | - | 100mA | |
| | | 0.8 | BLA31BD102SN4 ^{p93} | 1000Ω±25% | - | 50mA | |
| For GHz | For High-Speed Signal Lines | 0201 (0603) | 0.3 | BLM03HB191SN1 ^{p94} | 190Ω±25% | 1150Ω±40% | 150mA |
| | | | 0.3 | BLM03HB401SN1 ^{p94} | 400Ω±25% | 1850Ω±40% | 125mA |
| | | | 0.3 | BLM03HD102FN1 ^{p94} | 1000Ω±25% | 2300Ω±40% | 135mA |
| | | | 0.3 | BLM03HD152FN1 ^{p94} | 1500Ω±25% | 2700Ω±40% | 120mA |
| | | | 0.3 | BLM03HD182FN1 ^{p94} | 1800Ω±25% | 3000Ω±40% | 100mA |
| | | | 0.3 | BLM03HD331SN1 ^{p94} | 330Ω±25% | 750Ω±40% | 200mA |
| | | | 0.3 | BLM03HD471SN1 ^{p94} | 470Ω±25% | 1000Ω±40% | 175mA |
| | | | 0.3 | BLM03HD601SN1 ^{p94} | 600Ω±25% | 1500Ω±40% | 150mA |
| | | | 0.3 | BLM03HD102SN1 ^{p94} | 1000Ω±25% | 2300Ω±40% | 120mA |
| | | | 0.3 | BLM03HG601SN1 ^{p94} | 600Ω±25% | 1000Ω±40% | 150mA |
| | For General Signal Lines | | 0.3 | BLM03HG102SN1 ^{p94} | 1000Ω±25% | 1800Ω±40% | 125mA |
| | | | 0.3 | BLM03HG122SN1 ^{p94} | 1200Ω±25% | 2000Ω±40% | 100mA |
| | Universal Type [Power Lines/Signal Lines] | | 0.3 | BLM03EB250SN1 ^{p96} | 25Ω±25% | 105Ω±40% | 600mA |
| | | | 0.3 | BLM03EB500SN1 ^{p96} | 50Ω±25% | 255Ω±40% | 400mA |
| | For High-Speed Signal Lines (Sharp Impedance Curve) | | 0.5 | BLM15HB121SN1 ^{p97} | 120Ω±25% | 500Ω±40% | 300mA |
| | | | 0.5 | BLM15HB221SN1 ^{p97} | 220Ω±25% | 900Ω±40% | 250mA |
| | | | 0.5 | BLM15HD601SN1 ^{p97} | 600Ω±25% | 1400Ω±40% | 300mA |
| | | | 0.5 | BLM15HD102SN1 ^{p97} | 1000Ω±25% | 2000Ω±40% | 250mA |
| | | | 0.5 | BLM15HD182SN1 ^{p97} | 1800Ω±25% | 2700Ω±40% | 200mA |
| | For General Signal Lines | | 0.5 | BLM15HG601SN1 ^{p97} | 600Ω±25% | 1000Ω±40% | 300mA |
| 0.5 | | | BLM15HG102SN1 ^{p97} | 1000Ω±25% | 1400Ω±40% | 250mA | |
| Universal Type [Power Lines/Signal Lines] | 0402 (1005) | 0.5 | BLM15EG121SN1 ^{p99} | 120Ω±25% | 145Ω (Typ.) | 1.5A | |
| | | 0.5 | BLM15EG221SN1 ^{p99} | 220Ω±25% | 270Ω (Typ.) | 700mA | |
| | | 0.5 | BLM15EX121SN1 ^{p100} | 120Ω±25% | 170Ω±40% | 1.8A | |
| | | 0.5 | BLM15EX221SN1 ^{p100} | 220Ω±25% | 300Ω±40% | 1.3A | |
| | | 0.5 | BLM15EX331SN1 ^{p100} | 330Ω±25% | 450Ω±40% | 1.1A | |
| | | 0.5 | BLM15EX471SN1 ^{p100} | 470Ω±25% | 630Ω±40% | 950mA | |
| | | 0.5 | BLM15GA750SN1 ^{p102} | 75Ω±25% | 1000Ω±40% | 200mA | |
| | | 0.5 | BLM15GG221SN1 ^{p102} | 220Ω±25% | 600Ω±40% | 300mA | |
| For High-GHz Band Noise For High-Speed Signal Lines | | | | | | | |
| For High-GHz Band Noise For General Signal Lines | | | | | | | |

Continued on the following page. ↗

| Type | Size Code in inches (mm) | Thickness (mm) | Part Number | Impedance | | Rated Current | |
|---------|--|---------------------------|---------------------------|---------------------------|---------------------------|------------------|-------------|
| | | | | at 100MHz | at 1GHz | | |
| For GHz | For High-GHz Band Noise For General Signal Lines | 0402 (1005) | 0.5 | BLM15GG471SN1 p102 | 470Ω±25% | 1200Ω±40% | 200mA |
| | For High-Speed Signal Lines (Sharp Impedance Curve) | 0603 (1608) | 0.8 | BLM18HB121SN1 p103 | 120Ω±25% | 500Ω±40% | 200mA |
| | | | 0.8 | BLM18HB221SN1 p103 | 220Ω±25% | 1100Ω±40% | 100mA |
| | | | 0.8 | BLM18HB331SN1 p103 | 330Ω±25% | 1600Ω±40% | 50mA |
| | | | 0.8 | BLM18HD471SN1 p103 | 470Ω±25% | 1000Ω (Typ.) | 100mA |
| | | | 0.8 | BLM18HD601SN1 p103 | 600Ω±25% | 1200Ω (Typ.) | 100mA |
| | | | 0.8 | BLM18HD102SN1 p103 | 1000Ω±25% | 1700Ω (Typ.) | 50mA |
| | | | 0.8 | BLM18HE601SN1 p103 | 600Ω±25% | 600Ω (Typ.) | 800mA |
| | | | 0.8 | BLM18HE102SN1 p103 | 1000Ω±25% | 1000Ω (Typ.) | 600mA |
| | | | 0.8 | BLM18HE152SN1 p103 | 1500Ω±25% | 1500Ω (Typ.) | 500mA |
| | | | For General Signal Lines | 0.8 | BLM18HG471SN1 p103 | 470Ω±25% | 600Ω (Typ.) |
| | 0.8 | BLM18HG601SN1 p103 | | 600Ω±25% | 700Ω (Typ.) | 200mA | |
| | 0.8 | BLM18HG102SN1 p103 | | 1000Ω±25% | 1000Ω (Typ.) | 100mA | |
| | For Digital Interface Lines | 0.8 | BLM18HK331SN1 p103 | 330Ω±25% | 400Ω±40% | 200mA | |
| | | 0.8 | BLM18HK471SN1 p103 | 470Ω±25% | 600Ω±40% | 200mA | |
| | | 0.8 | BLM18HK601SN1 p103 | 600Ω±25% | 700Ω±40% | 100mA | |
| | | 0.8 | BLM18HK102SN1 p103 | 1000Ω±25% | 1200Ω±40% | 50mA | |
| | Universal Type [Power Lines/Signal Lines] | 0.8 | BLM18EG121SN1 p107 | 120Ω±25% | 145Ω (Typ.) | 2A | |
| | | 0.8 | BLM18EG221SN1 p107 | 220Ω±25% | 260Ω (Typ.) | 2A | |
| | | 0.8 | BLM18EG471SN1 p107 | 470Ω±25% | 550Ω (Typ.) | 500mA | |
| | | 0.8 | BLM18EG601SN1 p107 | 600Ω±25% | 700Ω (Typ.) | 500mA | |
| | | 0.5 | BLM18EG101TN1 p107 | 100Ω±25% | 140Ω (Typ.) | 2A | |
| | | 0.5 | BLM18EG221TN1 p107 | 220Ω±25% | 300Ω (Typ.) | 1A | |
| | | 0.5 | BLM18EG331TN1 p107 | 330Ω±25% | 450Ω (Typ.) | 500mA | |
| | | 0.5 | BLM18EG391TN1 p107 | 390Ω±25% | 520Ω (Typ.) | 500mA | |
| | For High-GHz Band Noise | 0.8 | BLM18GG471SN1 p109 | 470Ω±25% | 1800Ω±30% | 200mA | |

Chip Ferrite Bead

Application Specified Noise Filter

Chip EMIFIL®

Common Mode Choke Coil
 · Common Mode Noise Filter

Block Type EMIFIL®

EMC Absorber

Chip ferrite bead

BLM02PX Series 01005/0402(inch/mm)

Appearance/Dimensions

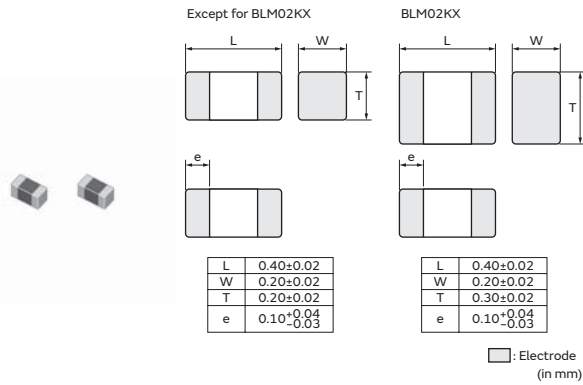

Packaging

| Code | Packaging | Minimum Quantity |
|------|-------------------|------------------|
| D | ø180mm Paper Tape | 20000 |
| B | Bulk(Bag) | 1000 |

Equivalent Circuit



(Resistance element becomes dominant at high frequencies.)

Rated Value (□: packaging code)

| Part Number | Impedance at 100MHz | Rated Current at 85°C | Rated Current at 125°C | DC Resistance |
|----------------|---------------------|-----------------------|------------------------|---------------|
| BLM02PX100SN1□ | 10Ω±5Ω | 1.1A | 850mA | 0.05Ω |
| BLM02PX220SN1□ | 22Ω±25% | 750mA | 550mA | 0.11Ω |
| BLM02PX330SN1□ | 33Ω±25% | 550mA | 400mA | 0.2Ω |
| BLM02PX600SN1□ | 60Ω±25% | 500mA | 350mA | 0.25Ω |

Operating Temp. Range: -55°C to 125°C

Z-f characteristics

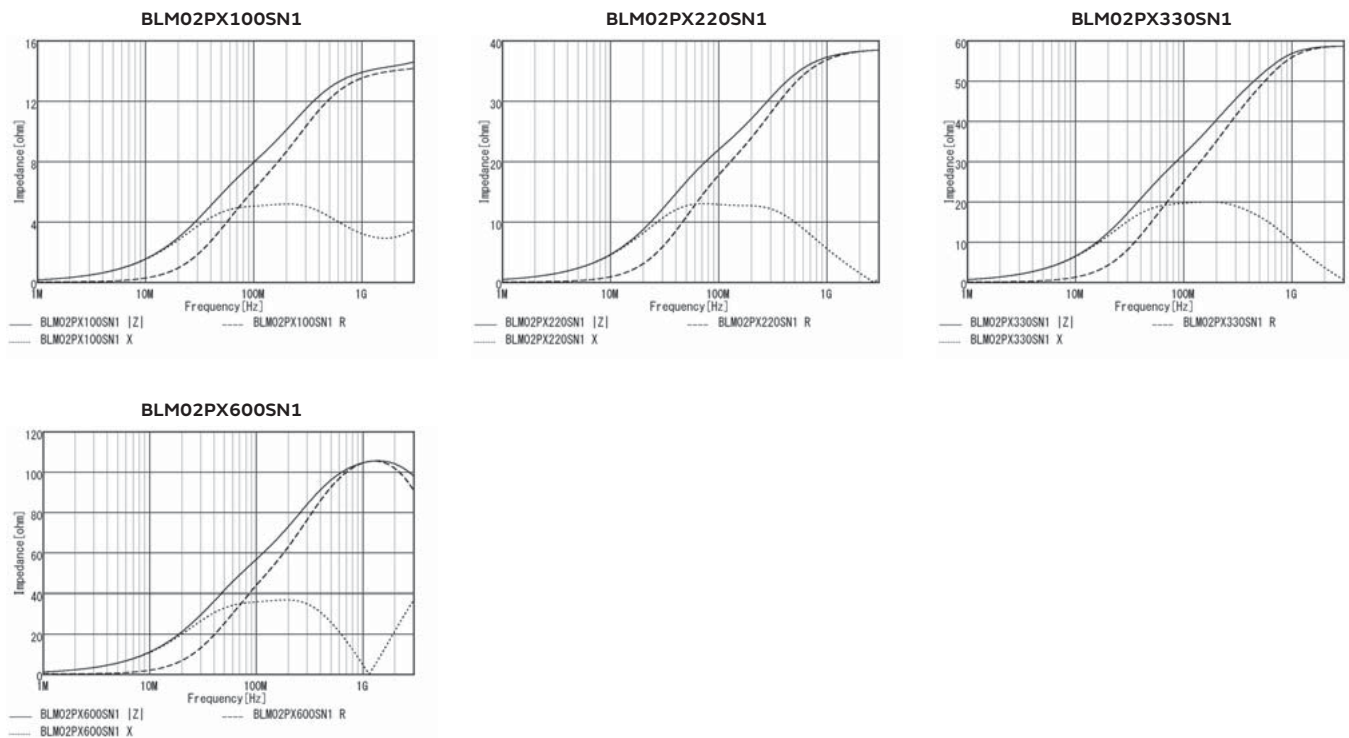

Continued on the following page. ↗

Continued from the preceding page. ↘

Derating of Rated Current

In operating temperature exceeding +85°C, derating of current is necessary for BLM02PX series.
Please apply the derating curve shown in chart according to the operating temperature.

Derating of Rated Current

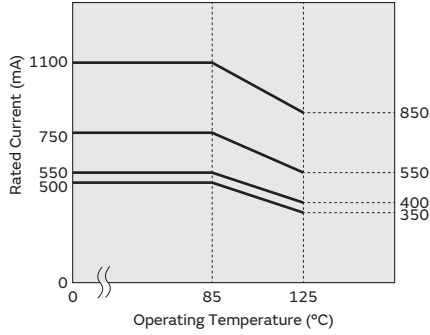

Chip ferrite bead

BLM02KX Series 01005/0402(inch/mm)

Appearance/Dimensions

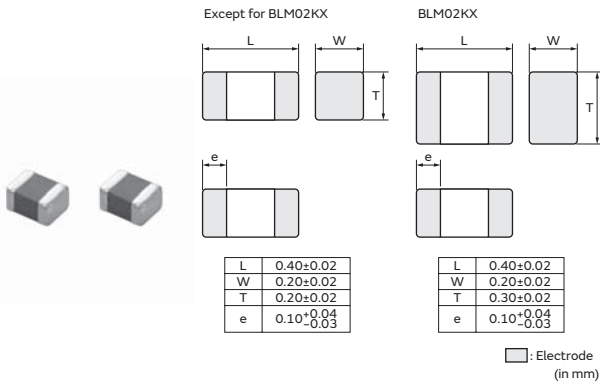

Packaging

| Code | Packaging | Minimum Quantity |
|------|-------------------|------------------|
| D | ø180mm Paper Tape | 15000 |
| B | Bulk(Bag) | 1000 |

Equivalent Circuit

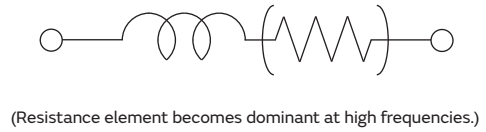

Rated Value (□: packaging code)

| Part Number | Impedance at 100MHz | Rated Current at 85°C | Rated Current at 125°C | DC Resistance |
|----------------|---------------------|-----------------------|------------------------|---------------|
| BLM02KX100SN1□ | 10Ω±5Ω | 1.5A | 1.25A | 0.03Ω |
| BLM02KX180SN1□ | 18Ω±25% | 1.2A | 950mA | 0.045Ω |

Operating Temp. Range: -55°C to 125°C

Z-f characteristics

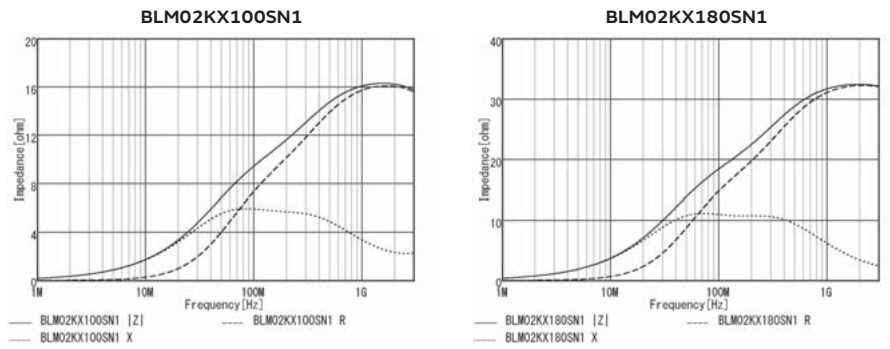

Derating of Rated Current

In operating temperature exceeding +85°C, derating of current is necessary for this series.
 Please apply the derating curve shown in chart according to the operating temperature.

Derating of Rated Current

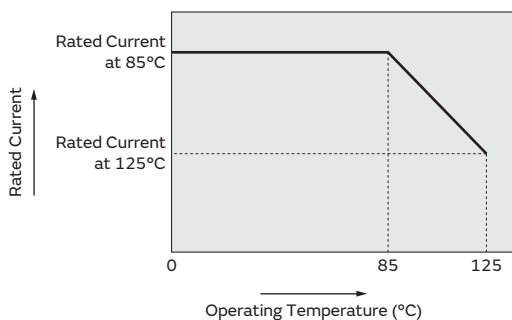

Chip ferrite bead

BLM02AX Series 01005/0402(inch/mm)

Appearance/Dimensions

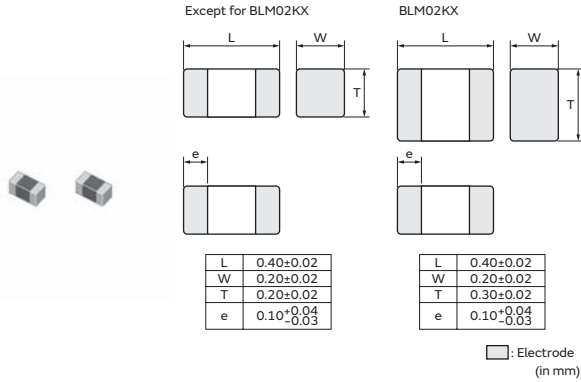

Packaging

| Code | Packaging | Minimum Quantity |
|------|-------------------|------------------|
| D | ø180mm Paper Tape | 20000 |
| B | Bulk(Bag) | 1000 |

Equivalent Circuit



(Resistance element becomes dominant at high frequencies.)

Rated Value (□: packaging code)

| Part Number | Impedance at 100MHz | Rated Current at 85°C | Rated Current at 125°C | DC Resistance |
|----------------|---------------------|-----------------------|------------------------|---------------|
| BLM02AX100SN1□ | 10Ω±5Ω | 750mA | 750mA | 0.07Ω |
| BLM02AX700SN1□ | 70Ω±25% | 300mA | 300mA | 0.36Ω |
| BLM02AX121SN1□ | 120Ω±25% | 250mA | 250mA | 0.5Ω |
| BLM02AX241SN1□ | 240Ω±25% | 200mA | 200mA | 0.9Ω |

Operating Temp. Range: -55°C to 125°C

Z-f characteristics

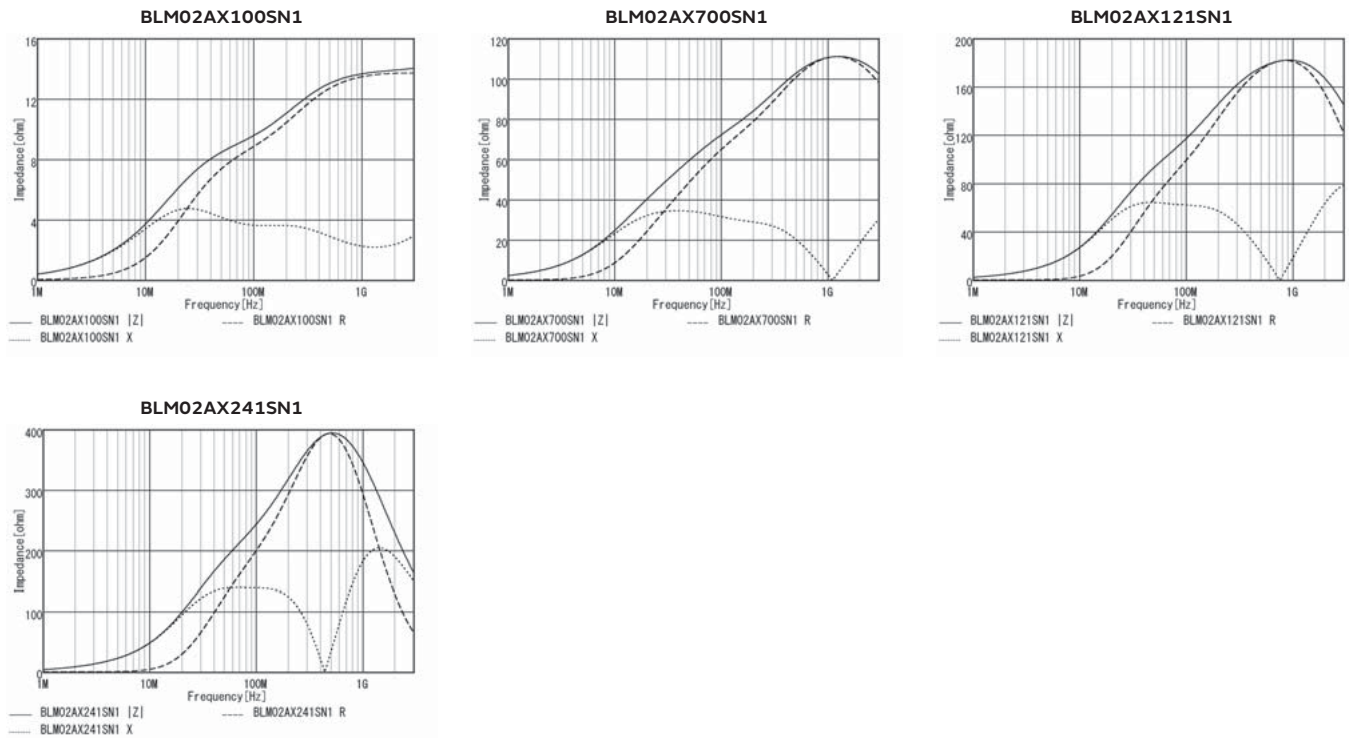

Chip Ferrite Bead (BLM□□AX Series) Feature Advantage

Excellent for Both Signal and Power Lines.
Multi Function Chip Ferrite Bead BLM□□AX Series

Feature

- 1/2 the DC resistance than conventional type utilizing the latest technology
 - New ferrite material
 - Optimum ferrite firing condition
 - Fine piling technology
 - Advanced coil pattern design technology
- Improved stability of performance at heat shock
- Wide line-up from 10 to 1000ohm(@100MHz) useful for signal line

Advantage

- High Rated Current
 - Good for miniaturization of high power equipment
- Lower Voltage down at Ferrite bead
 - Good for Battery driven equipment by saving running voltage margin
- Higher Reliability

Drastically Reduced DC Resistance

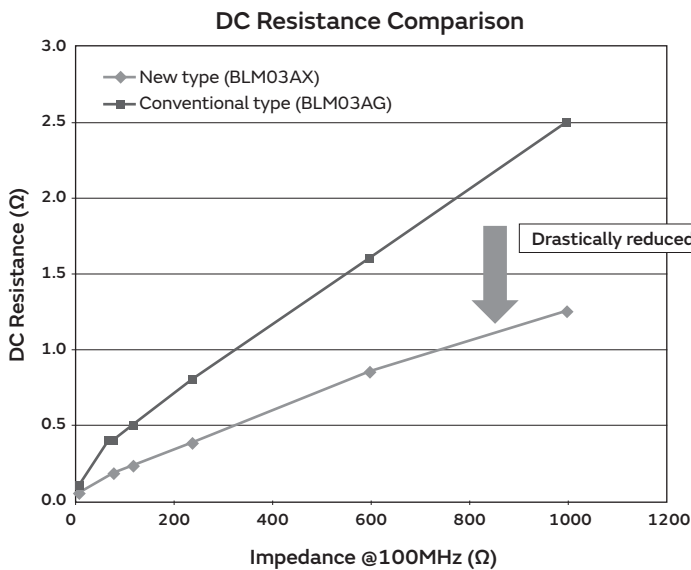

Test Result - Heat Shock

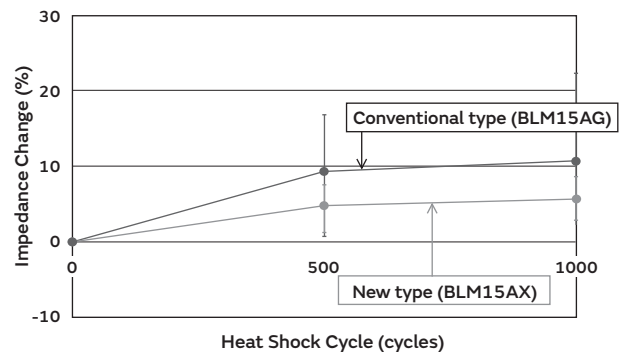

Chip Ferrite Bead

Application Specified Noise Filter

Chip EMIFIL®

Common Mode Choke Coil
 Common Mode Noise Filter

Block Type EMIFIL®

EMC Absorber

Chip ferrite bead

BLM02BB/BC Series 01005/0402(inch/mm)

Appearance/Dimensions

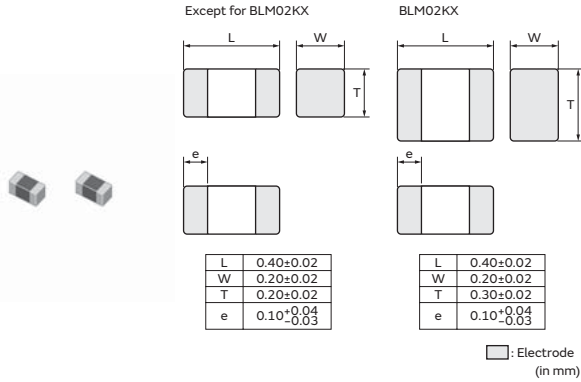

Packaging

BLM02BB101SN1 only

| Code | Packaging | Minimum Quantity |
|------|----------------------|------------------|
| D | ø180mm Paper Tape | 20000 |
| L | ø180mm Embossed Tape | 40000 |

All except for BLM02BB101SN1

| Code | Packaging | Minimum Quantity |
|------|----------------------|------------------|
| D | ø180mm Paper Tape | 20000 |
| L | ø180mm Embossed Tape | 40000 |
| B | Bulk(Bag) | 1000 |

Equivalent Circuit



(Resistance element becomes dominant at high frequencies.)

Rated Value (□: packaging code)

| Part Number | Impedance at 100MHz | Impedance at 1GHz | Impedance at 2GHz | Rated Current at 85°C | Rated Current at 125°C | DC Resistance |
|----------------|---------------------|-------------------|-------------------|-----------------------|------------------------|---------------|
| BLM02BB101SN1□ | 100Ω±25% | - | - | 125mA | 125mA | 2Ω |
| BLM02BC100SN1□ | 10Ω±5Ω | 95Ω±50% | 140Ω±50% | 250mA | 250mA | 0.5Ω |
| BLM02BC220SN1□ | 22Ω±25% | 240Ω±40% | 340Ω±40% | 200mA | 200mA | 0.9Ω |

Operating Temp. Range: -55°C to 125°C

Z-f characteristics

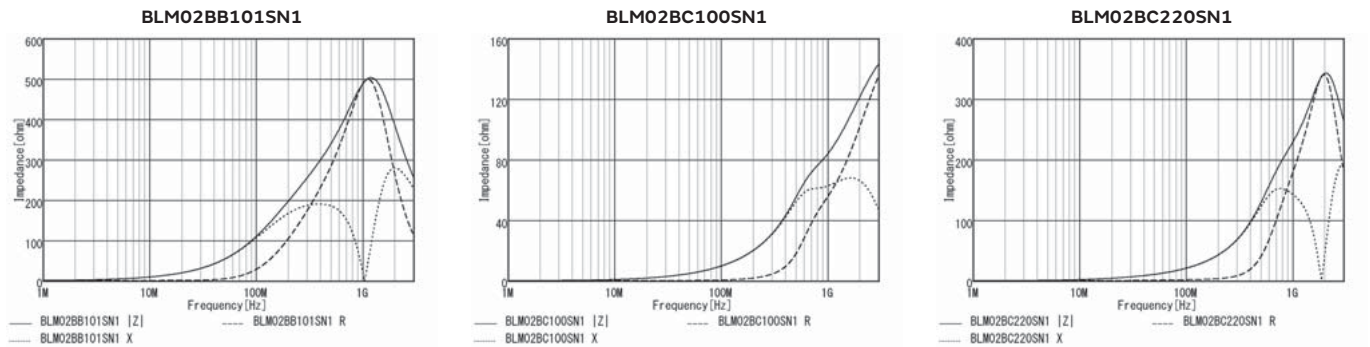

Chip ferrite bead

BLM02BX Series 01005/0402(inch/mm)

Appearance/Dimensions

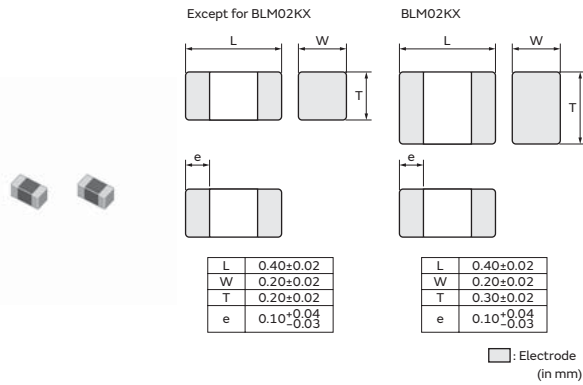

Packaging

| Code | Packaging | Minimum Quantity |
|------|-------------------|------------------|
| D | ø180mm Paper Tape | 20000 |
| B | Bulk(Bag) | 1000 |

Equivalent Circuit



(Resistance element becomes dominant at high frequencies.)

Rated Value (□: packaging code)

| Part Number | Impedance at 100MHz | Rated Current at 85°C | Rated Current at 125°C | DC Resistance |
|----------------|---------------------|-----------------------|------------------------|---------------|
| BLM02BX121SN1□ | 120Ω±25% | 350mA | 240mA | 0.5Ω |
| BLM02BX151SN1□ | 150Ω±25% | 280mA | 200mA | 0.7Ω |
| BLM02BX241SN1□ | 240Ω±25% | 240mA | 160mA | 1.1Ω |

Operating Temp. Range: -55°C to 125°C

Z-f characteristics

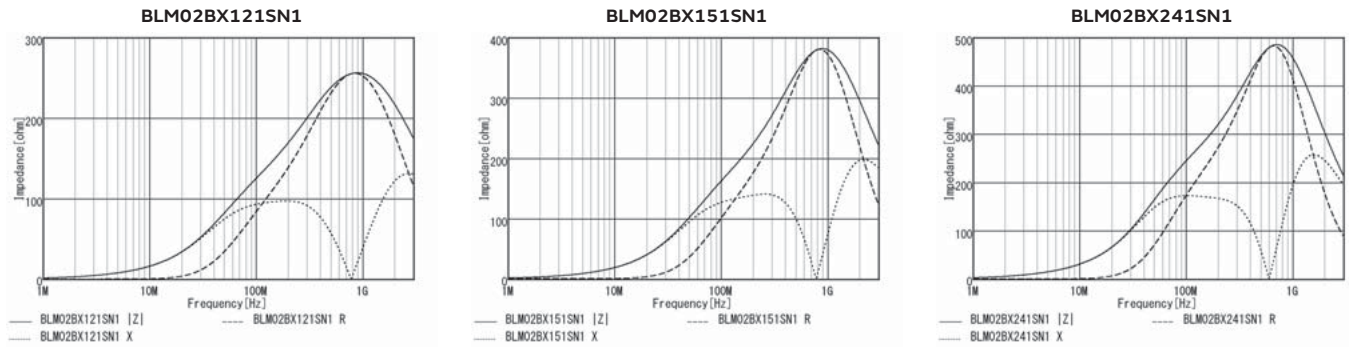

Derating of Rated Current

In operating temperature exceeding +85°C, derating of current is necessary for BLM02BX series. Please apply the derating curve shown in chart according to the operating temperature.

Derating of Rated Current

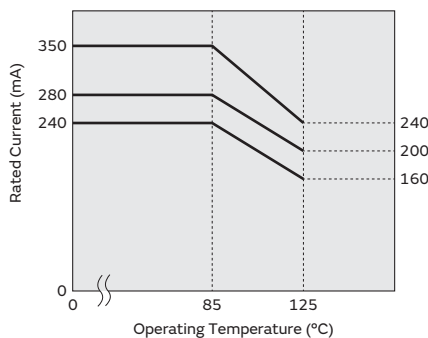

Chip ferrite bead

BLM03PG Series 0201/0603(inch/mm)

Appearance/Dimensions

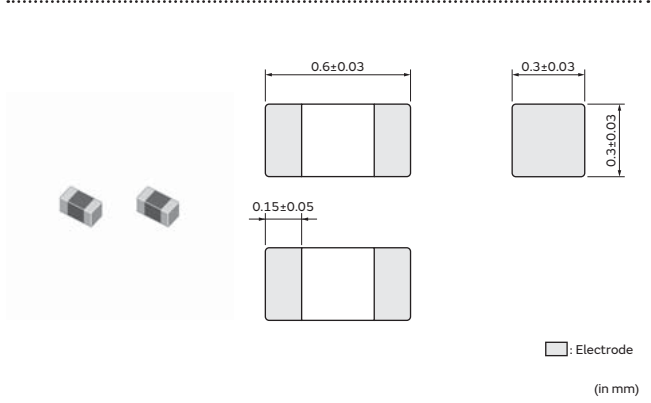

Packaging

| Code | Packaging | Minimum Quantity |
|------|-------------------|------------------|
| D | ø180mm Paper Tape | 15000 |
| J | ø330mm Paper Tape | 50000 |
| B | Bulk(Bag) | 1000 |

Equivalent Circuit



(Resistance element becomes dominant at high frequencies.)

Rated Value (□: packaging code)

| Part Number | Impedance at 100MHz | Rated Current at 85°C | Rated Current at 125°C | DC Resistance |
|----------------|---------------------|-----------------------|------------------------|---------------|
| BLM03PG220SN1□ | 22Ω±25% | 900mA | 900mA | 0.065Ω |
| BLM03PG330SN1□ | 33Ω±25% | 750mA | 750mA | 0.09Ω |

Operating Temp. Range: -55°C to 125°C

Z-f characteristics

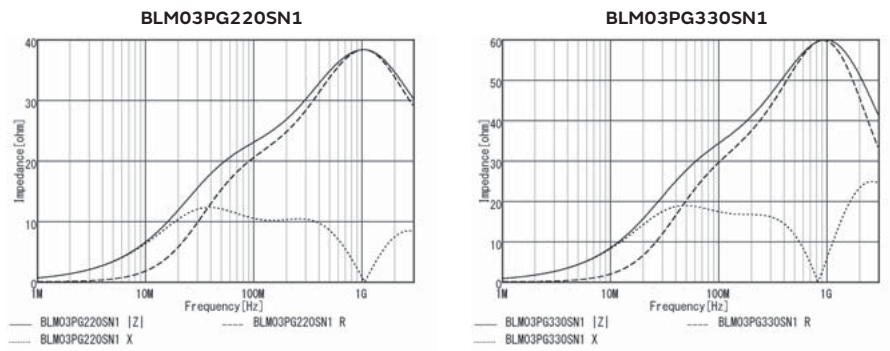

Chip ferrite bead

BLM03PX Series 0201/0603(inch/mm)

Appearance/Dimensions

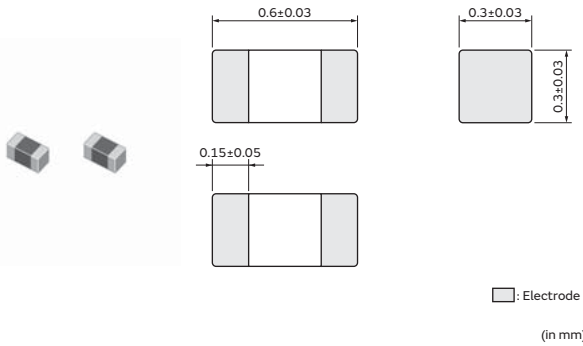

Packaging

| Code | Packaging | Minimum Quantity |
|------|-------------------|------------------|
| D | ø180mm Paper Tape | 15000 |
| J | ø330mm Paper Tape | 50000 |
| B | Bulk(Bag) | 1000 |

Equivalent Circuit



(Resistance element becomes dominant at high frequencies.)

Rated Value (□: packaging code)

| Part Number | Impedance at 100MHz | Rated Current at 85°C | Rated Current at 125°C | DC Resistance |
|----------------|---------------------|-----------------------|------------------------|---------------|
| BLM03PX220SN1□ | 22Ω±25% | 1.8A | 1.45A | 0.04Ω |
| BLM03PX330SN1□ | 33Ω±25% | 1.5A | 1.2A | 0.055Ω |
| BLM03PX800SN1□ | 80Ω±25% | 1A | 800mA | 0.13Ω |
| BLM03PX121SN1□ | 120Ω±25% | 900mA | 700mA | 0.16Ω |

Operating Temp. Range: -55°C to 125°C

Z-f characteristics

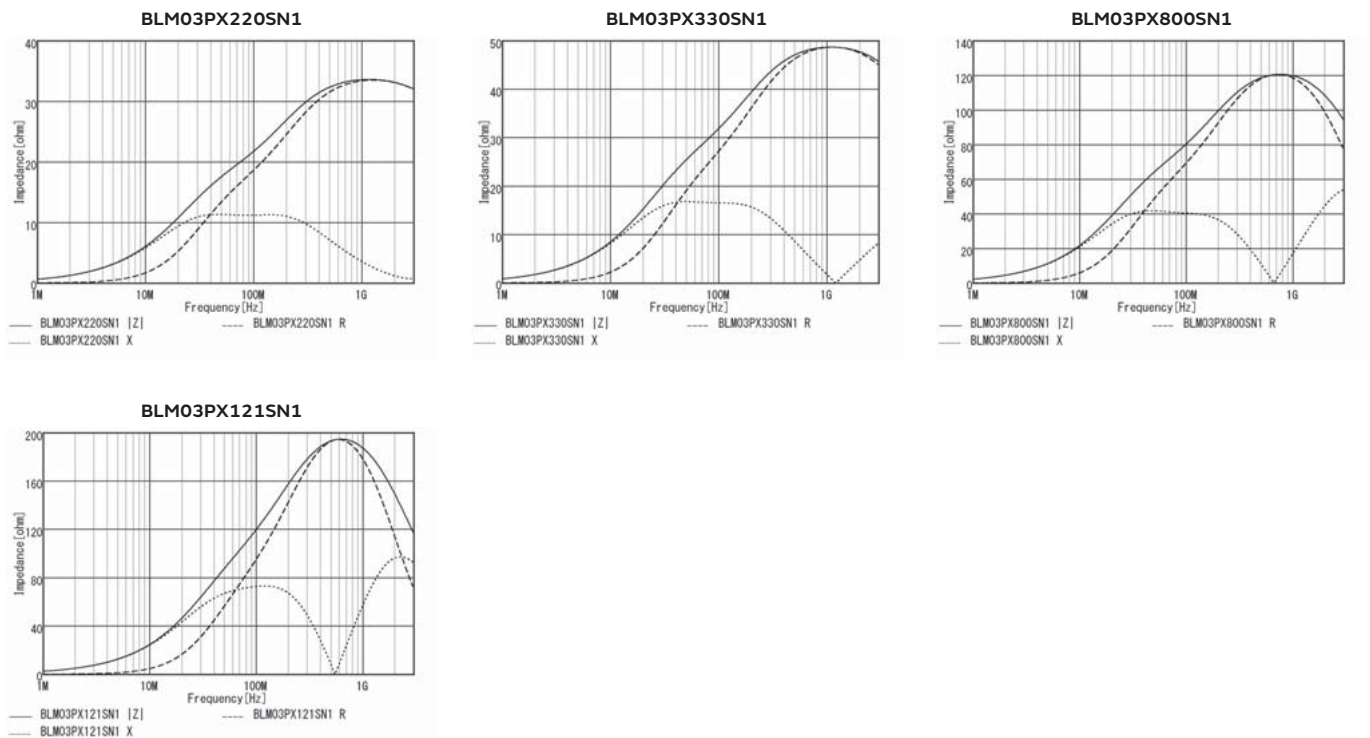

Continued on the following page. ↗

Continued from the preceding page. ↘

Derating of Rated Current

In operating temperature exceeding +85°C, derating of current is necessary for BLM03PX_S□1 series. Please apply the derating curve shown in chart according to the operating temperature.

Derating of Rated Current

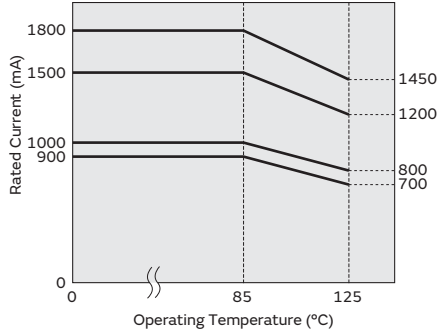

Chip ferrite bead

BLM03AG Series 0201/0603(inch/mm)

Appearance/Dimensions

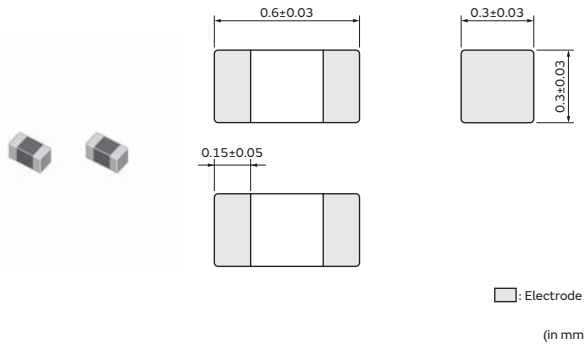

Packaging

| Code | Packaging | Minimum Quantity |
|------|-------------------|------------------|
| D | ø180mm Paper Tape | 15000 |
| J | ø330mm Paper Tape | 50000 |
| B | Bulk(Bag) | 1000 |

Equivalent Circuit



(Resistance element becomes dominant at high frequencies.)

Rated Value (□: packaging code)

| Part Number | Impedance at 100MHz | Rated Current at 85°C | Rated Current at 125°C | DC Resistance |
|----------------|---------------------|-----------------------|------------------------|---------------|
| BLM03AG100SN1□ | 10Ω(Typ.) | 500mA | 500mA | 0.1Ω |
| BLM03AG700SN1□ | 70Ω(Typ.) | 200mA | 200mA | 0.4Ω |
| BLM03AG800SN1□ | 80Ω±25% | 200mA | 200mA | 0.4Ω |
| BLM03AG121SN1□ | 120Ω±25% | 200mA | 200mA | 0.5Ω |
| BLM03AG241SN1□ | 240Ω±25% | 200mA | 200mA | 0.8Ω |
| BLM03AG601SN1□ | 600Ω±25% | 100mA | 100mA | 1.5Ω |
| BLM03AG102SN1□ | 1000Ω±25% | 100mA | 100mA | 2.5Ω |

Operating Temp. Range: -55°C to 125°C

Z-f characteristics

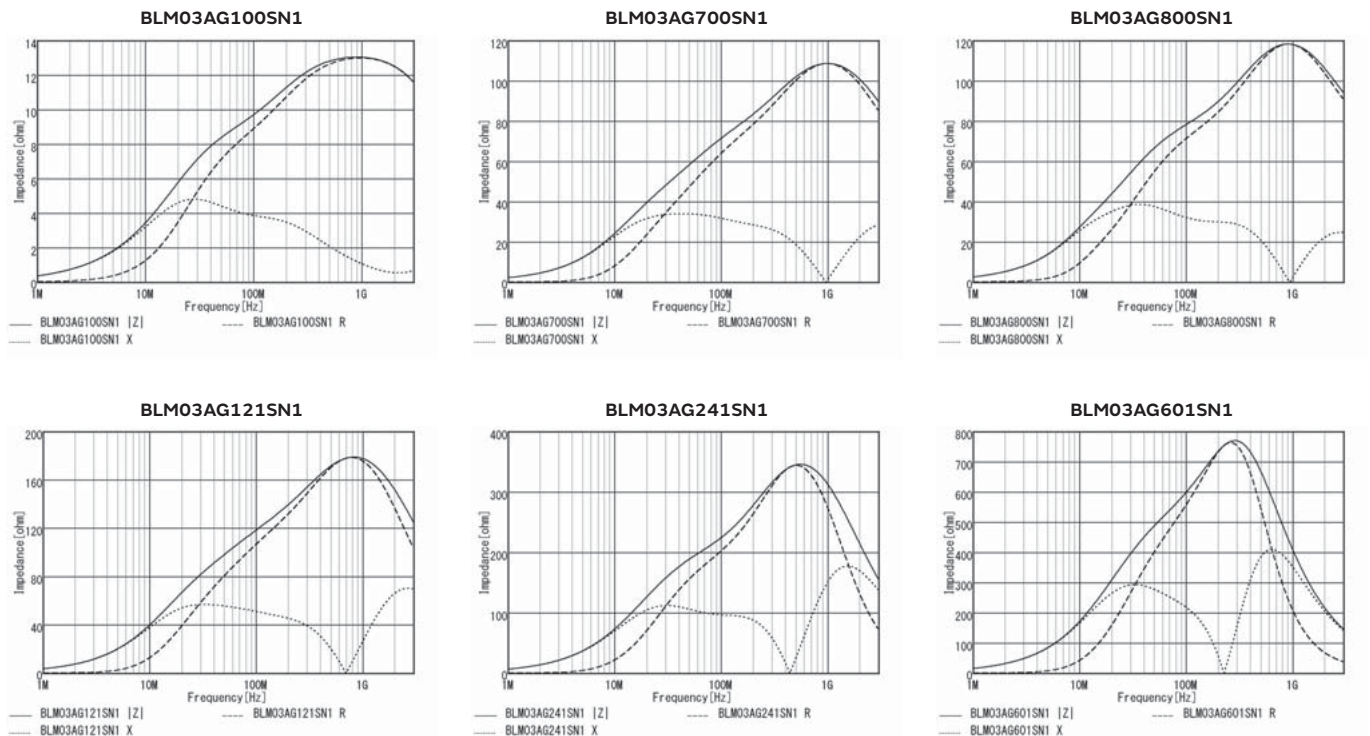

Continued on the following page. ↗

Continued from the preceding page. ↘

Z-f characteristics

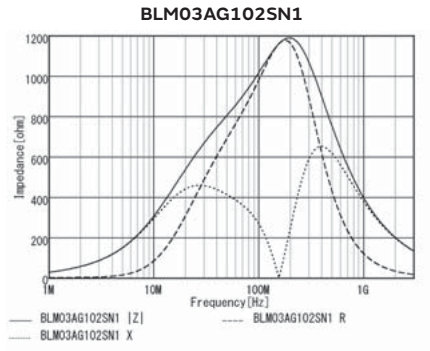

Chip Ferrite Bead

Application Specified Noise Filter

Chip EMIFIL®

Common Mode Choke Coil
 · Common Mode Noise Filter

Block Type EMIFIL®

EMC Absorber

Chip ferrite bead

BLM03AX Series 0201/0603(inch/mm)

Appearance/Dimensions

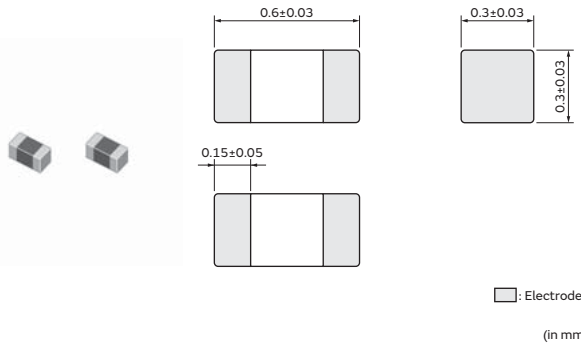

Packaging

| Code | Packaging | Minimum Quantity |
|------|-------------------|------------------|
| D | ø180mm Paper Tape | 15000 |
| J | ø330mm Paper Tape | 50000 |
| B | Bulk(Bag) | 1000 |

Equivalent Circuit



(Resistance element becomes dominant at high frequencies.)

Rated Value (□: packaging code)

| Part Number | Impedance at 100MHz | Rated Current at 85°C | Rated Current at 125°C | DC Resistance |
|----------------|---------------------|-----------------------|------------------------|---------------|
| BLM03AX100SN1□ | 10Ω(Typ.) | 1A | 1A | 0.05Ω |
| BLM03AX800SN1□ | 80Ω±25% | 500mA | 500mA | 0.18Ω |
| BLM03AX121SN1□ | 120Ω±25% | 450mA | 450mA | 0.23Ω |
| BLM03AX241SN1□ | 240Ω±25% | 350mA | 350mA | 0.38Ω |
| BLM03AX601SN1□ | 600Ω±25% | 250mA | 250mA | 0.85Ω |
| BLM03AX102SN1□ | 1000Ω±25% | 200mA | 200mA | 1.25Ω |

Operating Temp. Range: -55°C to 125°C

Z-f characteristics

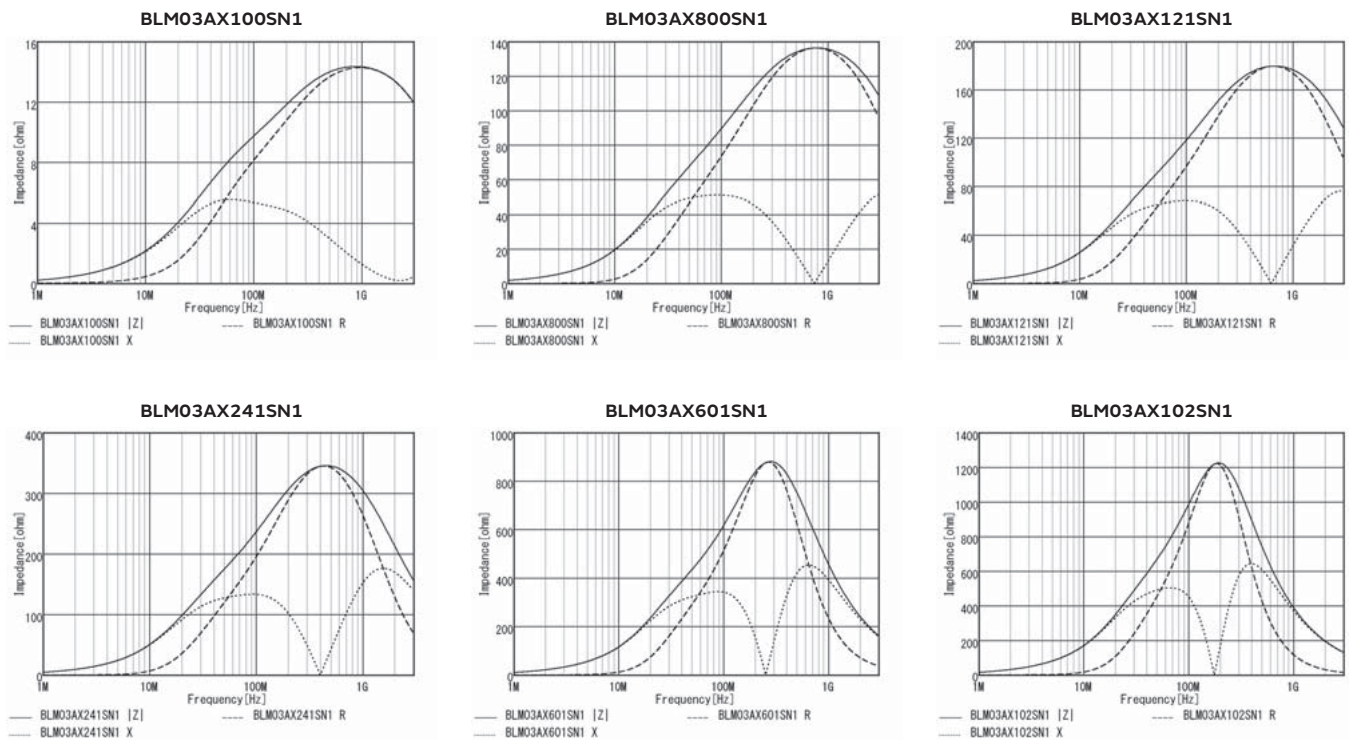

Chip ferrite bead

BLM03BB/BC/BD Series 0201/0603(inch/mm)

Appearance/Dimensions

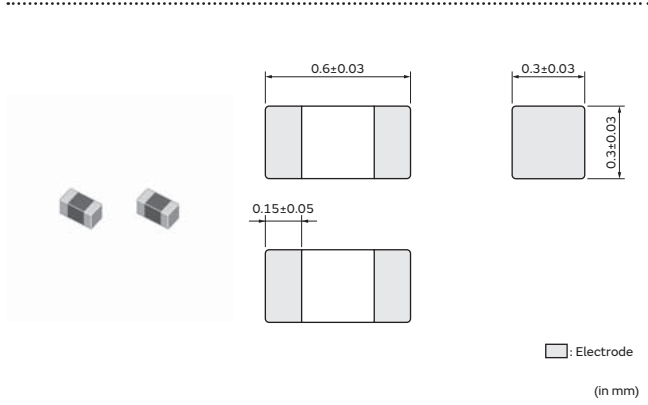

Packaging

| Code | Packaging | Minimum Quantity |
|------|-------------------|------------------|
| D | ø180mm Paper Tape | 15000 |
| J | ø330mm Paper Tape | 50000 |
| B | Bulk(Bag) | 1000 |

Equivalent Circuit



(Resistance element becomes dominant at high frequencies.)

Rated Value (□: packaging code)

| Part Number | Impedance at 100MHz | Rated Current at 85°C | Rated Current at 125°C | DC Resistance |
|----------------|---------------------|-----------------------|------------------------|---------------|
| BLM03BB100SN1□ | 10Ω±25% | 300mA | 300mA | 0.4Ω |
| BLM03BB220SN1□ | 22Ω±25% | 200mA | 200mA | 0.5Ω |
| BLM03BB470SN1□ | 47Ω±25% | 200mA | 200mA | 0.7Ω |
| BLM03BB750SN1□ | 75Ω±25% | 200mA | 200mA | 1Ω |
| BLM03BB121SN1□ | 120Ω±25% | 100mA | 100mA | 1.5Ω |
| BLM03BC330SN1□ | 33Ω±25% | 150mA | 150mA | 0.85Ω |
| BLM03BC560SN1□ | 56Ω±25% | 100mA | 100mA | 1.05Ω |
| BLM03BC800SN1□ | 80Ω±25% | 100mA | 100mA | 1.4Ω |
| BLM03BD750SN1□ | 75Ω±25% | 300mA | 300mA | 0.4Ω |
| BLM03BD121SN1□ | 120Ω±25% | 250mA | 250mA | 0.5Ω |
| BLM03BD241SN1□ | 240Ω±25% | 200mA | 200mA | 0.8Ω |
| BLM03BD471SN1□ | 470Ω±25% | 215mA | 215mA | 1.5Ω |
| BLM03BD601SN1□ | 600Ω±25% | 200mA | 200mA | 1.7Ω |

Operating Temp. Range: -55°C to 125°C

Z-f characteristics

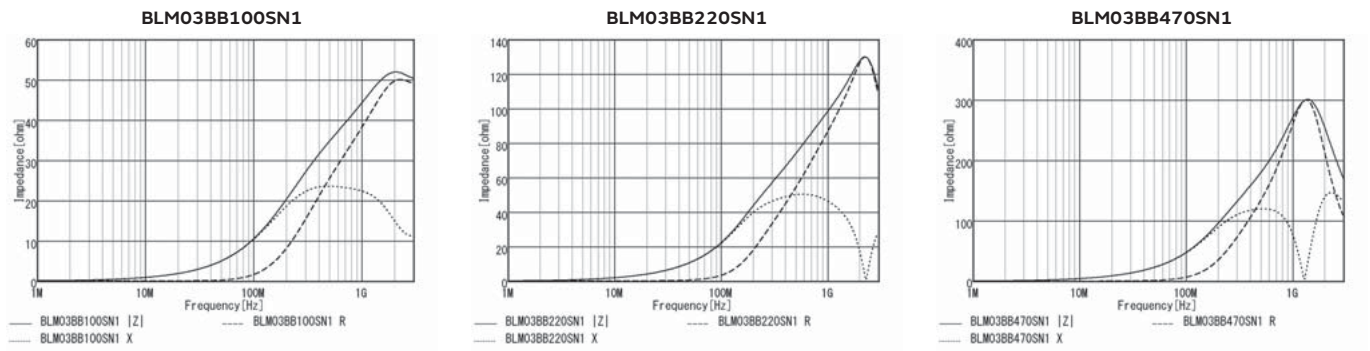

Continued on the following page. ↗

Continued from the preceding page. ↘

Z-f characteristics

BLM03BB750SN1

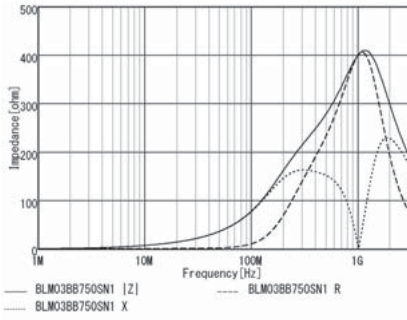

BLM03BB121SN1

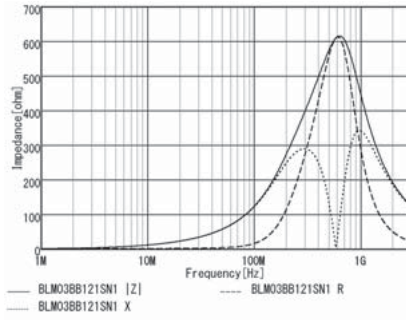

BLM03BC330SN1

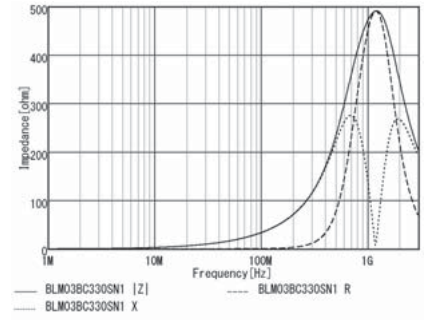

BLM03BC560SN1

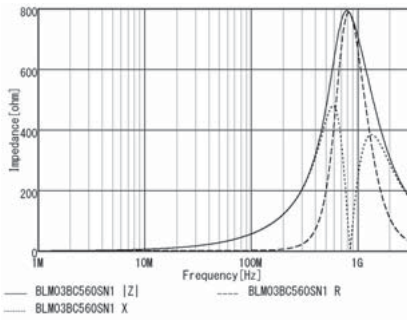

BLM03BC800SN1

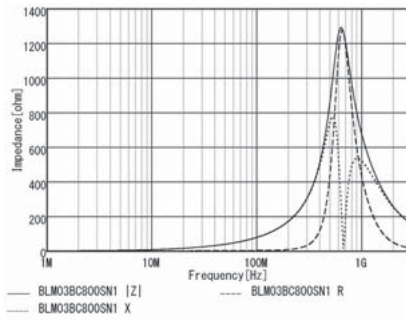

BLM03BD750SN1

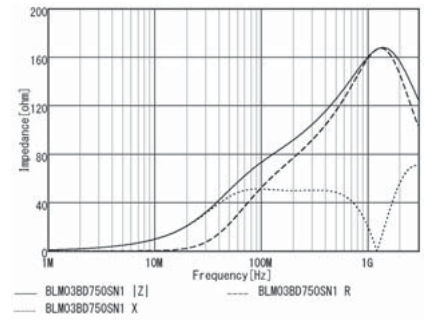

BLM03BD121SN1

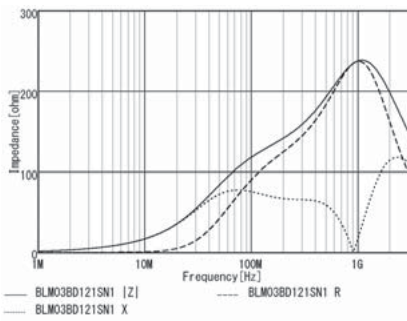

BLM03BD241SN1

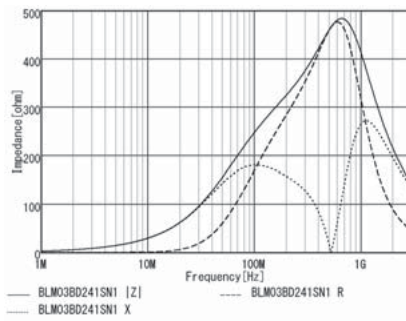

BLM03BD471SN1

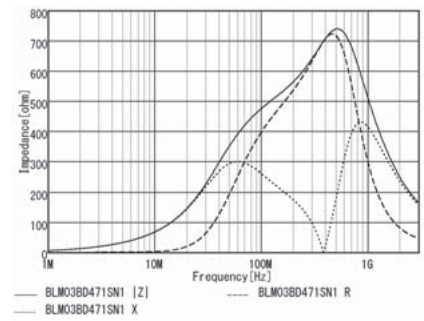

BLM03BD601SN1

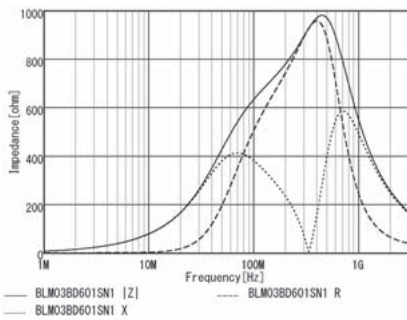

Chip ferrite bead

BLM03BX Series 0201/0603(inch/mm)

Appearance/Dimensions

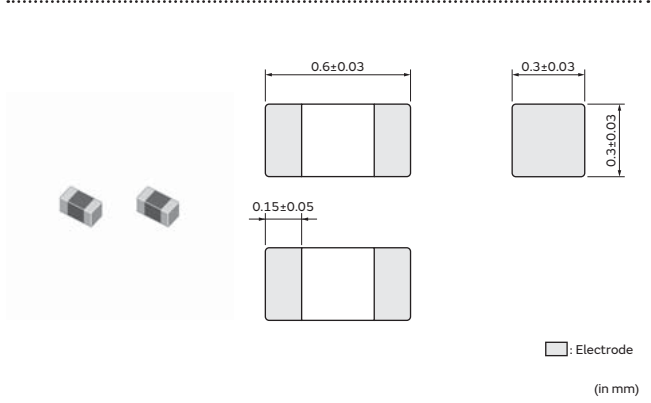

Packaging

| Code | Packaging | Minimum Quantity |
|------|-------------------|------------------|
| D | ø180mm Paper Tape | 15000 |
| J | ø330mm Paper Tape | 50000 |
| B | Bulk(Bag) | 1000 |

Equivalent Circuit

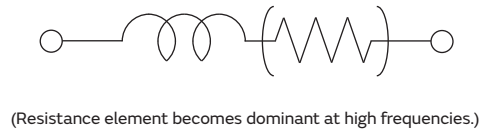

Rated Value (□: packaging code)

| Part Number | Impedance at 100MHz | Rated Current at 85°C | Rated Current at 125°C | DC Resistance |
|----------------|---------------------|-----------------------|------------------------|---------------|
| BLM03BX102SN1□ | 1000Ω±25% | 170mA | 170mA | 1.7Ω |
| BLM03BX182SN1□ | 1800Ω±25% | 140mA | 140mA | 2.5Ω |

Operating Temp. Range: -55°C to 125°C

Z-f characteristics

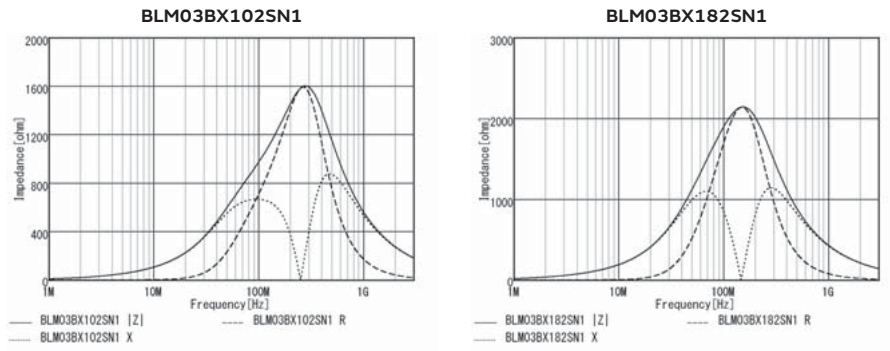

Chip ferrite bead

BLM15PD/PG Series 0402/1005(inch/mm)

Appearance/Dimensions

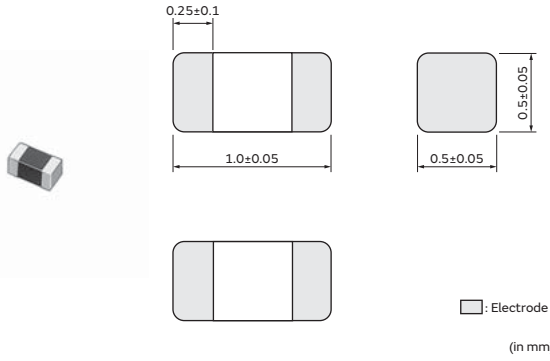

Packaging

| Code | Packaging | Minimum Quantity |
|------|-------------------|------------------|
| D | ø180mm Paper Tape | 10000 |
| J | ø330mm Paper Tape | 50000 |
| B | Bulk(Bag) | 1000 |

Equivalent Circuit



(Resistance element becomes dominant at high frequencies.)

Rated Value (□: packaging code)

| Part Number | Impedance at 100MHz | Rated Current at 85°C | Rated Current at 125°C | DC Resistance |
|----------------|---------------------|-----------------------|------------------------|---------------|
| BLM15PD300SN1□ | 30Ω±25% | 2.2A | 1.4A | 0.035Ω |
| BLM15PD600SN1□ | 60Ω±25% | 1.7A | 1.1A | 0.06Ω |
| BLM15PD800SN1□ | 80Ω±25% | 1.5A | 1A | 0.07Ω |
| BLM15PD121SN1□ | 120Ω±25% | 1.3A | 900mA | 0.09Ω |
| BLM15PG100SN1□ | 10Ω(Typ.) | 1A | 1A | 0.025Ω |

Operating Temp. Range: -55°C to 125°C

Z-f characteristics

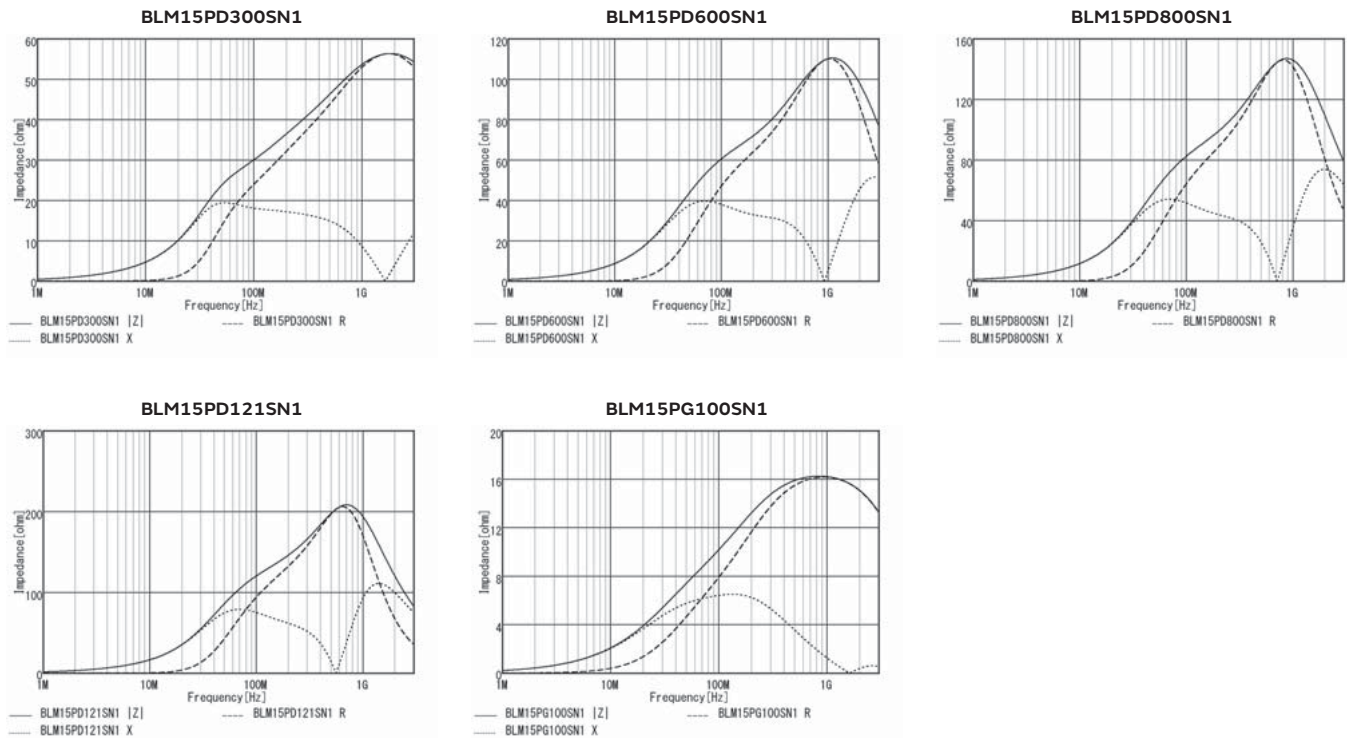

Continued on the following page. ↗

Continued from the preceding page. ↘

Derating of Rated Current

In operating temperature exceeding +85°C, derating of current is necessary for BLM15PD series.
 Please apply the derating curve shown in chart according to the operating temperature.

Derating of Rated Current

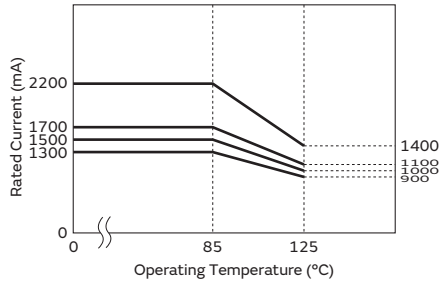

Chip ferrite bead

BLM15PX Series 0402/1005(inch/mm)

Appearance/Dimensions

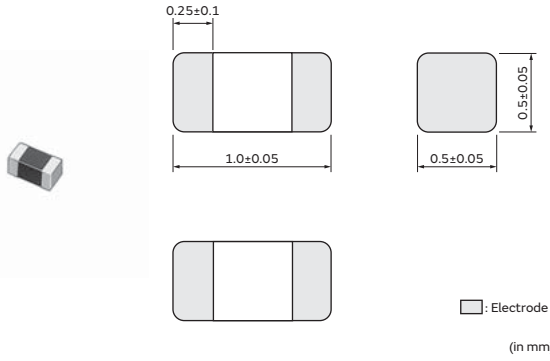

Packaging

| Code | Packaging | Minimum Quantity |
|------|-------------------|------------------|
| D | ø180mm Paper Tape | 10000 |
| J | ø330mm Paper Tape | 50000 |
| B | Bulk(Bag) | 1000 |

Equivalent Circuit



(Resistance element becomes dominant at high frequencies.)

Rated Value (□: packaging code)

| Part Number | Impedance at 100MHz | Rated Current at 85°C | Rated Current at 125°C | DC Resistance |
|----------------|---------------------|-----------------------|------------------------|---------------|
| BLM15PX330SN1□ | 33Ω±25% | 3A | 1.7A | 0.022Ω |
| BLM15PX600SN1□ | 60Ω±25% | 2.5A | 1.4A | 0.032Ω |
| BLM15PX800SN1□ | 80Ω±25% | 2.3A | 1.3A | 0.038Ω |
| BLM15PX121SN1□ | 120Ω±25% | 2A | 1.1A | 0.055Ω |
| BLM15PX181SN1□ | 180Ω±25% | 1.5A | 800mA | 0.09Ω |
| BLM15PX221SN1□ | 220Ω±25% | 1.4A | 800mA | 0.1Ω |
| BLM15PX331SN1□ | 330Ω±25% | 1.2A | 700mA | 0.15Ω |
| BLM15PX471SN1□ | 470Ω±25% | 1A | 600mA | 0.2Ω |
| BLM15PX601SN1□ | 600Ω±25% | 900mA | 500mA | 0.23Ω |

Operating Temp. Range: -55°C to 125°C

Z-f characteristics

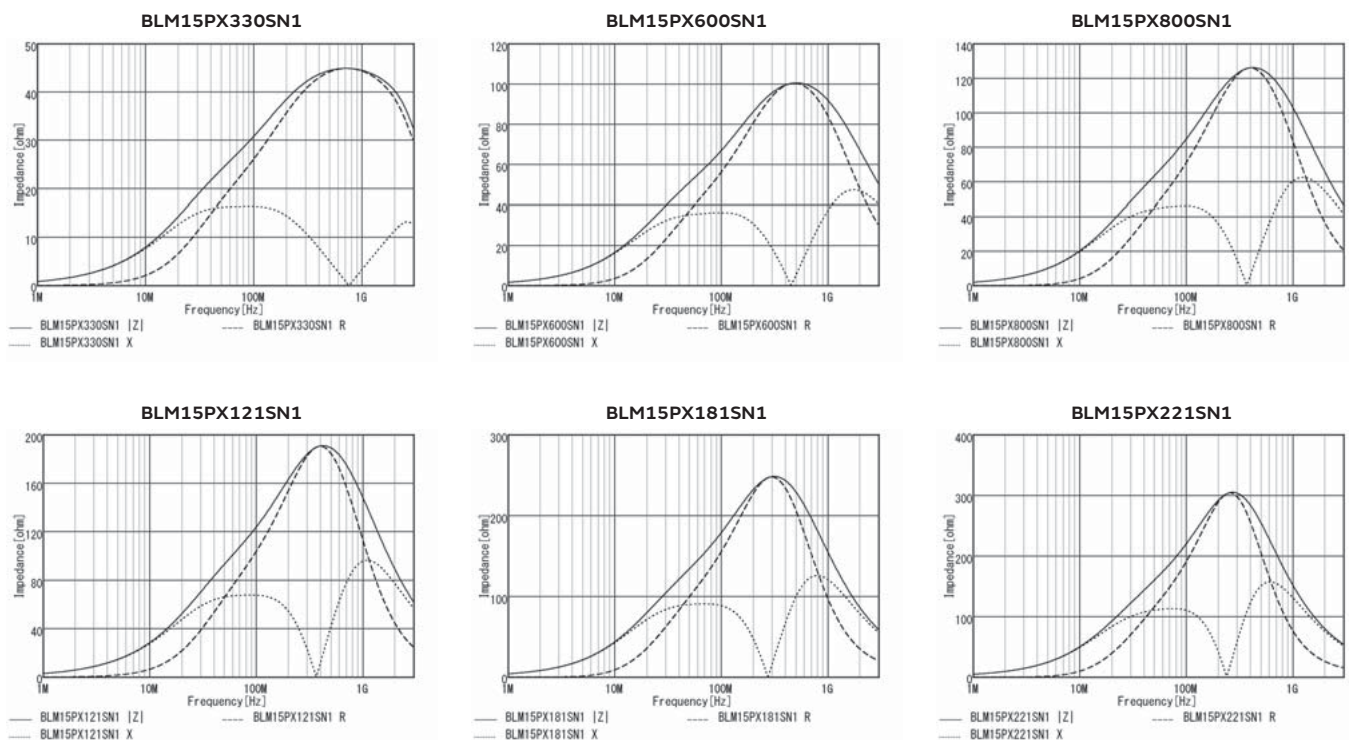

Continued from the preceding page. ↘

Z-f characteristics

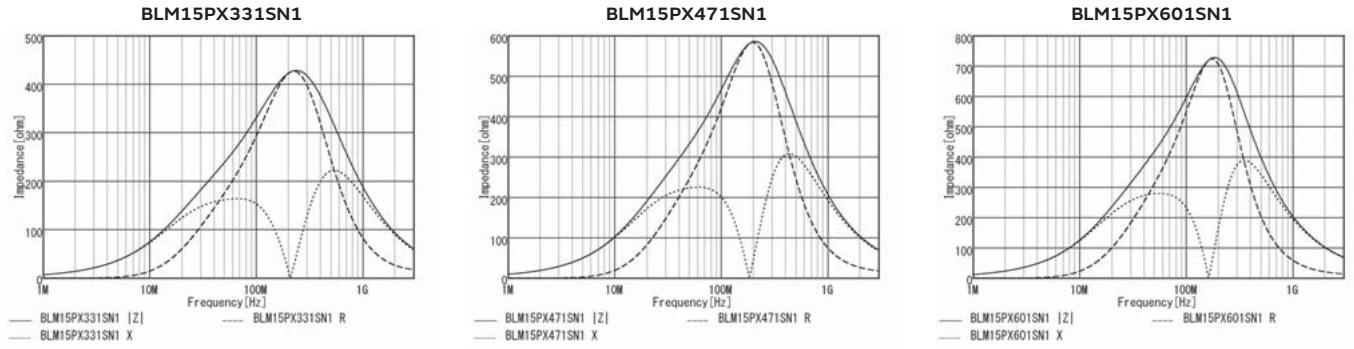

Derating of Rated Current

In operating temperature exceeding +85°C, derating of current is necessary for BLM15PX series.
 Please apply the derating curve shown in chart according to the operating temperature.

Derating of Rated Current

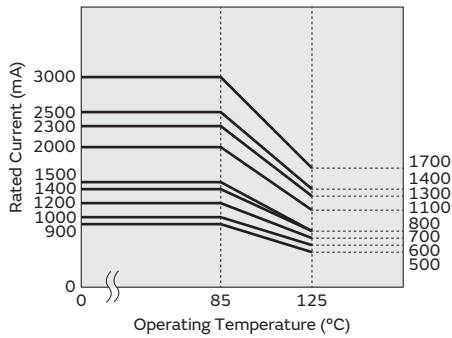

Chip ferrite bead

BLM15KD Series 0402/1005(inch/mm)

Appearance/Dimensions

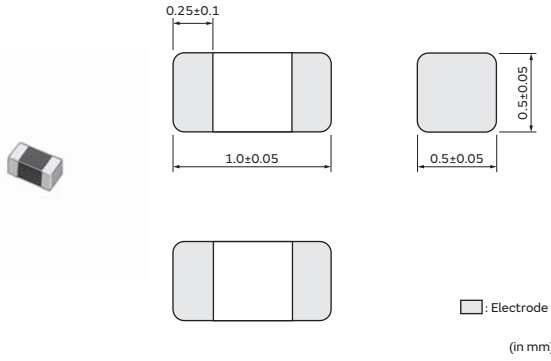

Packaging

| Code | Packaging | Minimum Quantity |
|------|-------------------|------------------|
| D | ø180mm Paper Tape | 10000 |
| J | ø330mm Paper Tape | 50000 |
| B | Bulk(Bag) | 1000 |

Equivalent Circuit



(Resistance element becomes dominant at high frequencies.)

Rated Value (□: packaging code)

| Part Number | Impedance at 100MHz | Rated Current at 85°C | Rated Current at 125°C | DC Resistance |
|----------------|---------------------|-----------------------|------------------------|---------------|
| BLM15KD200SN1□ | 20Ω±25% | 3.8A | 2.35A | 0.011Ω |
| BLM15KD300SN1□ | 30Ω±25% | 3.1A | 1.9A | 0.017Ω |
| BLM15KD121SN1□ | 120Ω±25% | 1.5A | 930mA | 0.07Ω |

Operating Temp. Range: -55°C to 125°C

Z-f characteristics

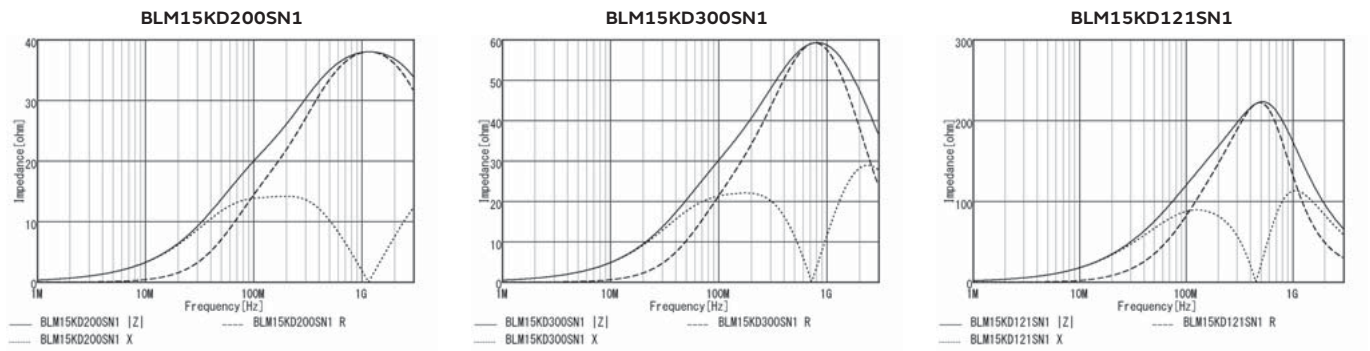

Derating of Rated Current

In operating temperature exceeding +85°C, derating of current is necessary for BLM15KD_SN1 series. Please apply the derating curve shown in chart according to the operating temperature.

Derating of Rated Current

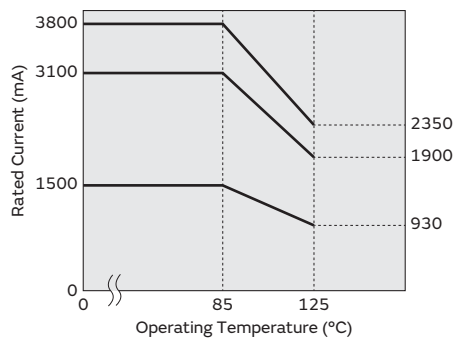

Chip ferrite bead

BLM15AG Series 0402/1005(inch/mm)

Appearance/Dimensions

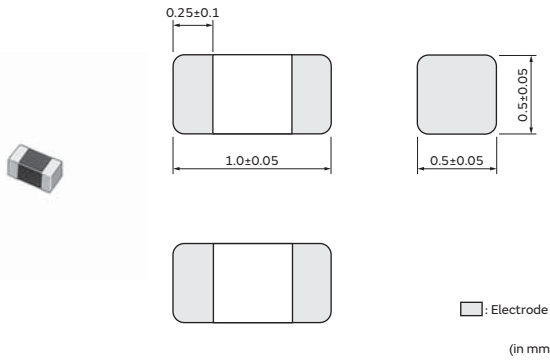

Packaging

| Code | Packaging | Minimum Quantity |
|------|-------------------|------------------|
| D | ø180mm Paper Tape | 10000 |
| J | ø330mm Paper Tape | 50000 |
| B | Bulk(Bag) | 1000 |

Equivalent Circuit



(Resistance element becomes dominant at high frequencies.)

Rated Value (□: packaging code)

| Part Number | Impedance at 100MHz | Rated Current at 85°C | Rated Current at 125°C | DC Resistance |
|----------------|---------------------|-----------------------|------------------------|---------------|
| BLM15AG100SN1□ | 10Ω(Typ.) | 1A | 1A | 0.025Ω |
| BLM15AG700SN1□ | 70Ω(Typ.) | 600mA | 600mA | 0.15Ω |
| BLM15AG121SN1□ | 120Ω±25% | 550mA | 550mA | 0.19Ω |
| BLM15AG221SN1□ | 220Ω±25% | 450mA | 450mA | 0.29Ω |
| BLM15AG601SN1□ | 600Ω±25% | 300mA | 300mA | 0.52Ω |
| BLM15AG102SN1□ | 1000Ω±25% | 300mA | 300mA | 0.65Ω |

Operating Temp. Range: -55°C to 125°C

Z-f characteristics

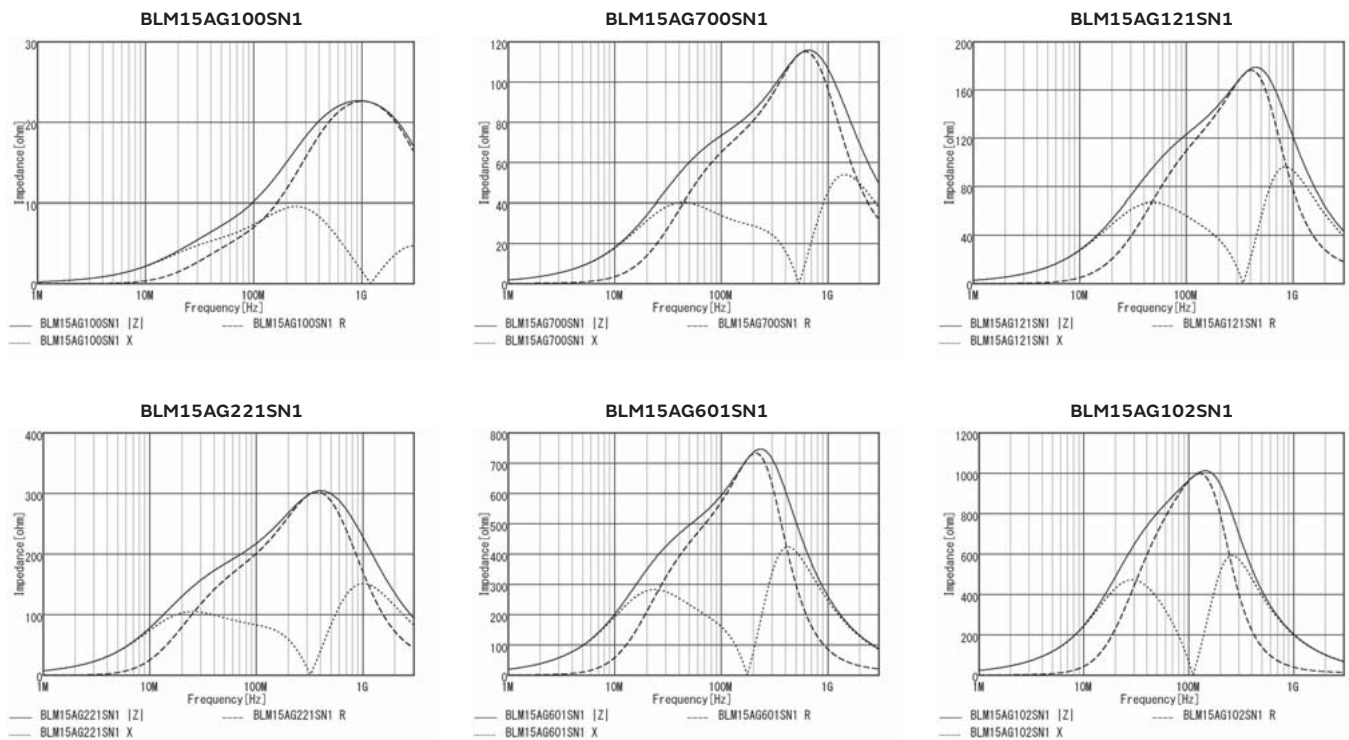

Chip ferrite bead

BLM15AX Series 0402/1005(inch/mm)

Appearance/Dimensions

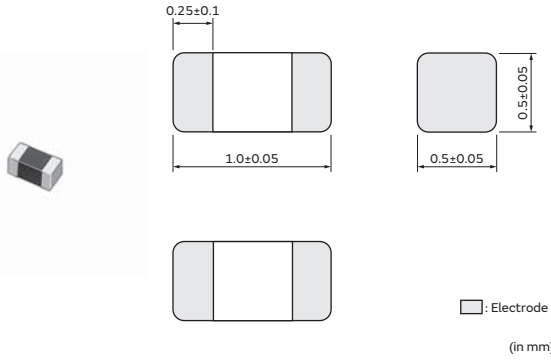

Packaging

| Code | Packaging | Minimum Quantity |
|------|-------------------|------------------|
| D | ø180mm Paper Tape | 10000 |
| J | ø330mm Paper Tape | 50000 |
| B | Bulk(Bag) | 1000 |

Equivalent Circuit



(Resistance element becomes dominant at high frequencies.)

Rated Value (□: packaging code)

| Part Number | Impedance at 100MHz | Rated Current at 85°C | Rated Current at 125°C | DC Resistance |
|----------------|---------------------|-----------------------|------------------------|---------------|
| BLM15AX100SN1□ | 10Ω±5% | 1.74A | 1.74A | 0.015Ω |
| BLM15AX300SN1□ | 30Ω±25% | 1.1A | 1.1A | 0.06Ω |
| BLM15AX700SN1□ | 70Ω±25% | 780mA | 780mA | 0.1Ω |
| BLM15AX121SN1□ | 120Ω±25% | 700mA | 700mA | 0.13Ω |
| BLM15AX221SN1□ | 220Ω±25% | 600mA | 600mA | 0.18Ω |
| BLM15AX601SN1□ | 600Ω±25% | 500mA | 500mA | 0.34Ω |
| BLM15AX102SN1□ | 1000Ω±25% | 350mA | 350mA | 0.49Ω |

Operating Temp. Range: -55°C to 125°C

Z-f characteristics

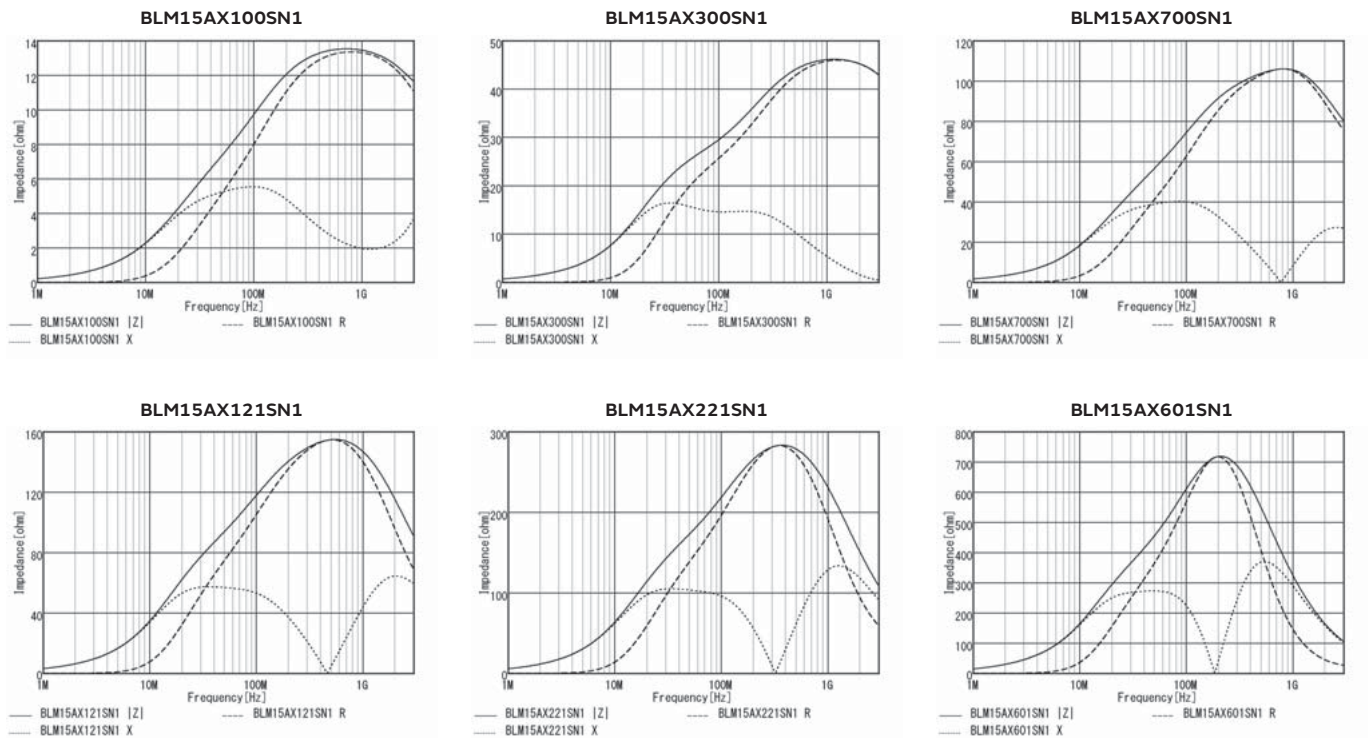

Continued on the following page. ↗

Continued from the preceding page. ↘

Z-f characteristics

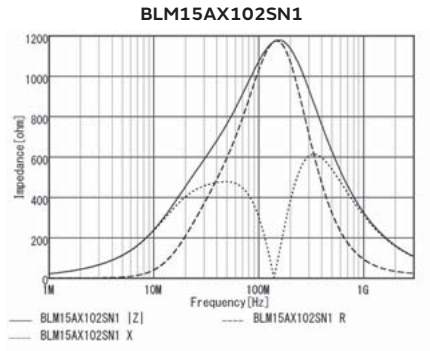

Chip ferrite bead

BLM15BA/BB/BC/BD Series 0402/1005(inch/mm)

Appearance/Dimensions

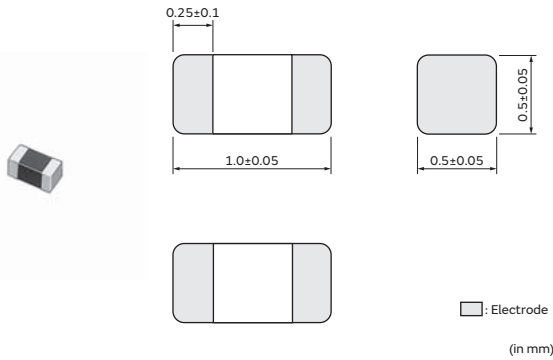

Packaging

| Code | Packaging | Minimum Quantity |
|------|-------------------|------------------|
| D | ø180mm Paper Tape | 10000 |
| J | ø330mm Paper Tape | 50000 |
| B | Bulk(Bag) | 1000 |

Equivalent Circuit



(Resistance element becomes dominant at high frequencies.)

Rated Value (□: packaging code)

| Part Number | Impedance at 100MHz | Rated Current at 85°C | Rated Current at 125°C | DC Resistance |
|----------------|---------------------|-----------------------|------------------------|---------------|
| BLM15BA050SN1□ | 5Ω±25% | 300mA | 300mA | 0.1Ω |
| BLM15BA100SN1□ | 10Ω±25% | 300mA | 300mA | 0.2Ω |
| BLM15BA220SN1□ | 22Ω±25% | 300mA | 300mA | 0.3Ω |
| BLM15BA330SN1□ | 33Ω±25% | 300mA | 300mA | 0.4Ω |
| BLM15BA470SN1□ | 47Ω±25% | 200mA | 200mA | 0.6Ω |
| BLM15BA750SN1□ | 75Ω±25% | 200mA | 200mA | 0.8Ω |
| BLM15BB050SN1□ | 5Ω±25% | 500mA | 500mA | 0.08Ω |
| BLM15BB100SN1□ | 10Ω±25% | 300mA | 300mA | 0.1Ω |
| BLM15BB220SN1□ | 22Ω±25% | 300mA | 300mA | 0.2Ω |
| BLM15BB470SN1□ | 47Ω±25% | 300mA | 300mA | 0.35Ω |
| BLM15BB750SN1□ | 75Ω±25% | 300mA | 300mA | 0.4Ω |
| BLM15BB121SN1□ | 120Ω±25% | 300mA | 300mA | 0.55Ω |
| BLM15BB221SN1□ | 220Ω±25% | 200mA | 200mA | 0.8Ω |
| BLM15BC121SN1□ | 120Ω±25% | 350mA | 350mA | 0.45Ω |
| BLM15BC241SN1□ | 240Ω±25% | 250mA | 250mA | 0.7Ω |
| BLM15BD750SN1□ | 75Ω±25% | 300mA | 300mA | 0.2Ω |
| BLM15BD121SN1□ | 120Ω±25% | 300mA | 300mA | 0.3Ω |
| BLM15BD221SN1□ | 220Ω±25% | 300mA | 300mA | 0.4Ω |
| BLM15BD471SN1□ | 470Ω±25% | 200mA | 200mA | 0.6Ω |
| BLM15BD601SN1□ | 600Ω±25% | 200mA | 200mA | 0.65Ω |
| BLM15BD102SN1□ | 1000Ω±25% | 200mA | 200mA | 0.9Ω |
| BLM15BD152SN1□ | 1500Ω±25% | 190mA | 190mA | 1Ω |
| BLM15BD182SN1□ | 1800Ω±25% | 100mA | 100mA | 1.4Ω |

Operating Temp. Range: -55°C to 125°C

Continued on the following page. ↗

Continued from the preceding page. ↘

Z-f characteristics

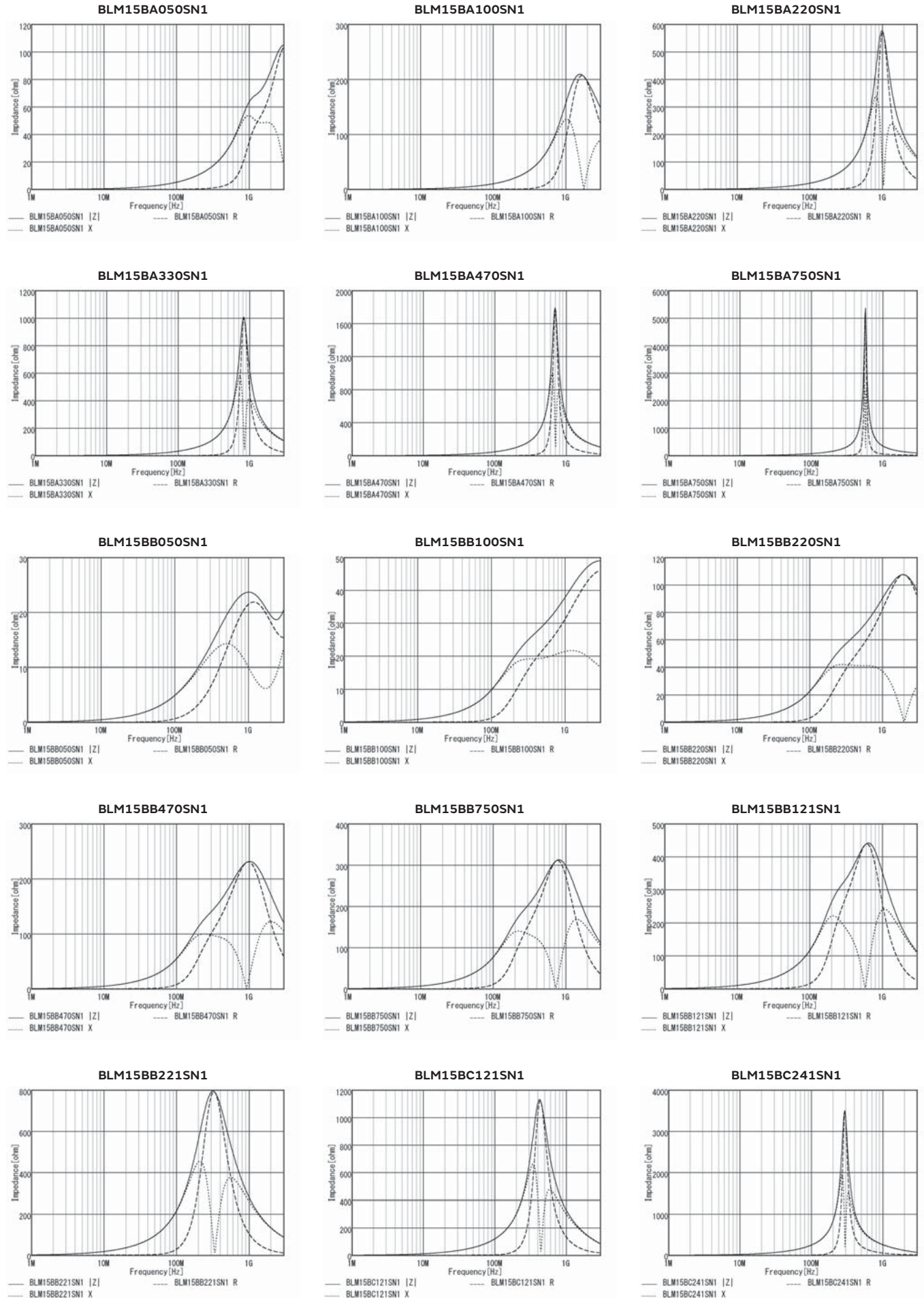

Chip Ferrite Bead

Application Specified Noise Filter

Chip EMIFIL®

Common Mode Choke Coil
 Common Mode Noise Filter

Block Type EMIFIL®

EMC Absorber

Continued from the preceding page. ↘

Z-f characteristics

BLM15BD750SN1

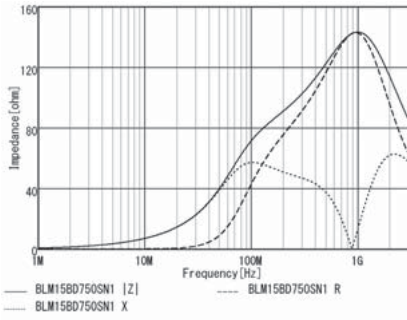

BLM15BD121SN1

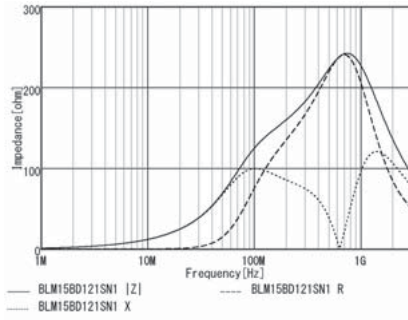

BLM15BD221SN1

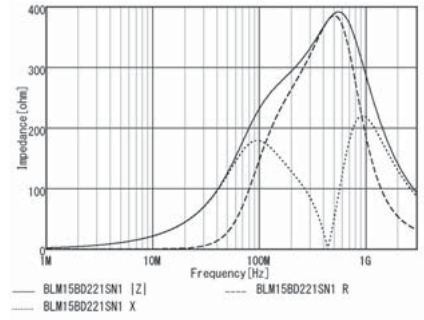

BLM15BD471SN1

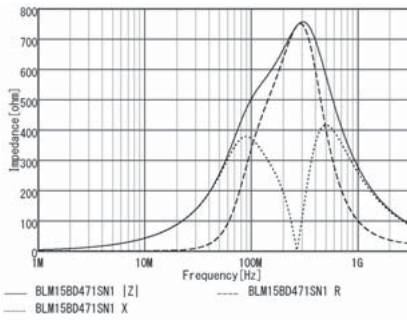

BLM15BD601SN1

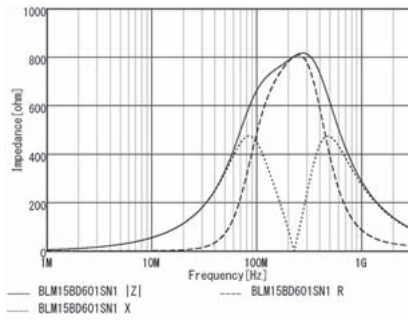

BLM15BD102SN1

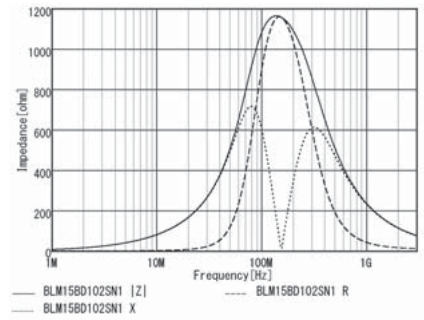

BLM15BD152SN1

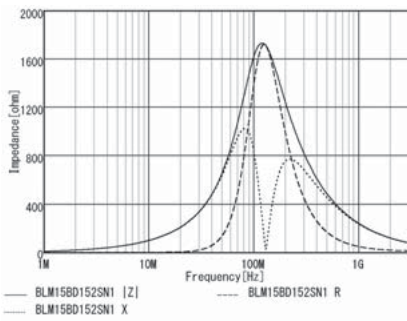

BLM15BD182SN1

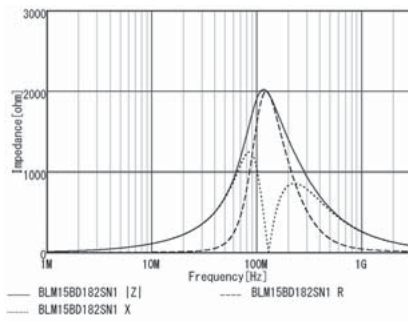

Chip ferrite bead

BLM15BX Series 0402/1005(inch/mm)

Appearance/Dimensions

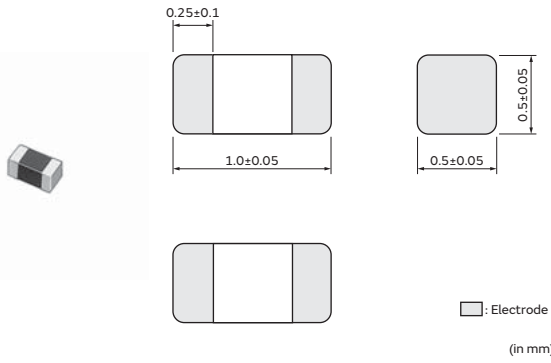

Packaging

| Code | Packaging | Minimum Quantity |
|------|-------------------|------------------|
| D | ø180mm Paper Tape | 10000 |
| J | ø330mm Paper Tape | 50000 |
| B | Bulk(Bag) | 1000 |

Equivalent Circuit



(Resistance element becomes dominant at high frequencies.)

Rated Value (□: packaging code)

| Part Number | Impedance at 100MHz | Rated Current at 85°C | Rated Current at 125°C | DC Resistance |
|----------------|---------------------|-----------------------|------------------------|---------------|
| BLM15BX750SN1□ | 75Ω±25% | 600mA | 600mA | 0.15Ω |
| BLM15BX121SN1□ | 120Ω±25% | 600mA | 600mA | 0.17Ω |
| BLM15BX221SN1□ | 220Ω±25% | 450mA | 450mA | 0.27Ω |
| BLM15BX471SN1□ | 470Ω±25% | 350mA | 350mA | 0.41Ω |
| BLM15BX601SN1□ | 600Ω±25% | 350mA | 350mA | 0.46Ω |
| BLM15BX102SN1□ | 1000Ω±25% | 300mA | 300mA | 0.65Ω |
| BLM15BX182SN1□ | 1800Ω±25% | 250mA | 250mA | 0.9Ω |

Operating Temp. Range: -55°C to 125°C

Z-f characteristics

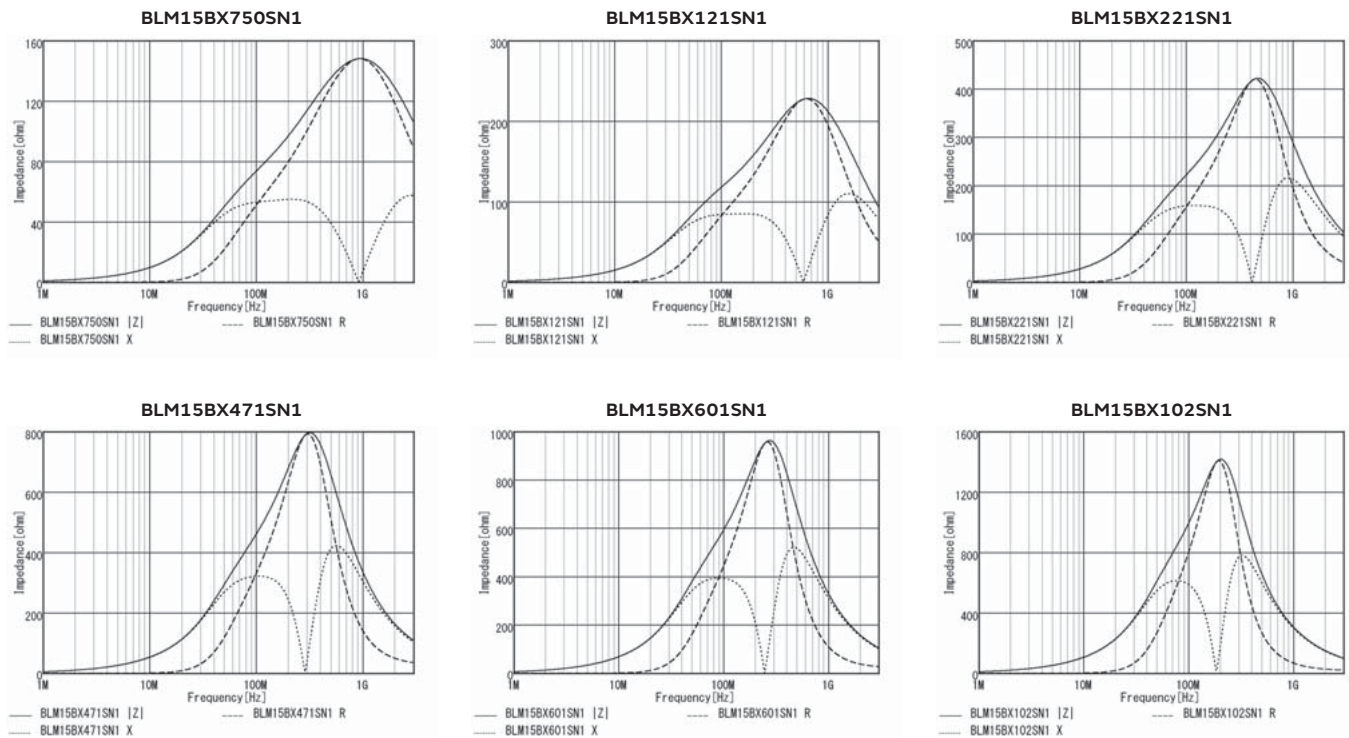

Continued on the following page. ↗

Continued from the preceding page. ↘

Z-f characteristics

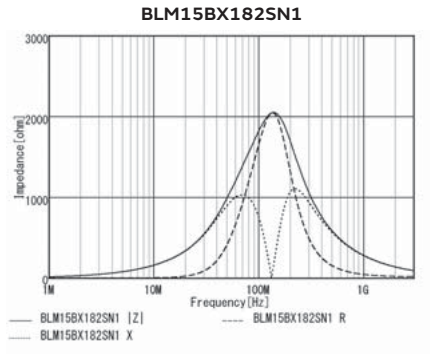

Chip Ferrite Bead

Application Specified Noise Filter

Chip EMIFIL®

Common Mode Choke Coil
Common Mode Noise Filter

Block Type EMIFIL®

EMC Absorber

Chip ferrite bead

BLM18PG Series 0603/1608(inch/mm)

Appearance/Dimensions

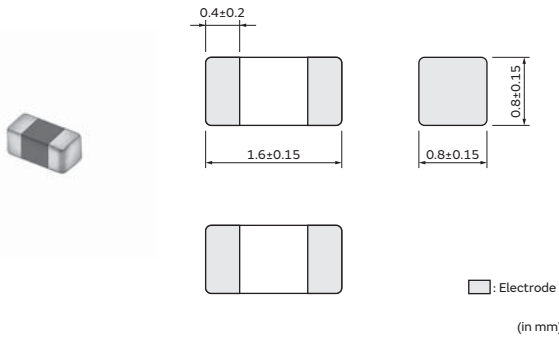

Packaging

| Code | Packaging | Minimum Quantity |
|------|-------------------|------------------|
| D | ø180mm Paper Tape | 4000 |
| J | ø330mm Paper Tape | 10000 |
| B | Bulk(Bag) | 1000 |

Equivalent Circuit



(Resistance element becomes dominant at high frequencies.)

Rated Value (□: packaging code)

| Part Number | Impedance at 100MHz | Rated Current at 85°C | Rated Current at 125°C | DC Resistance |
|----------------|---------------------|-----------------------|------------------------|---------------|
| BLM18PG300SN1□ | 30Ω(Typ.) | 1A | 1A | 0.05Ω |
| BLM18PG330SN1□ | 33Ω±25% | 3A | 1A | 0.025Ω |
| BLM18PG600SN1□ | 60Ω(Typ.) | 1A | 1A | 0.1Ω |
| BLM18PG121SN1□ | 120Ω±25% | 2A | 1A | 0.05Ω |
| BLM18PG181SN1□ | 180Ω±25% | 1.5A | 1A | 0.09Ω |
| BLM18PG221SN1□ | 220Ω±25% | 1.4A | 1A | 0.1Ω |
| BLM18PG331SN1□ | 330Ω±25% | 1.2A | 1A | 0.15Ω |
| BLM18PG471SN1□ | 470Ω±25% | 1A | 1A | 0.2Ω |

Operating Temp. Range: -55°C to 125°C

Z-f characteristics

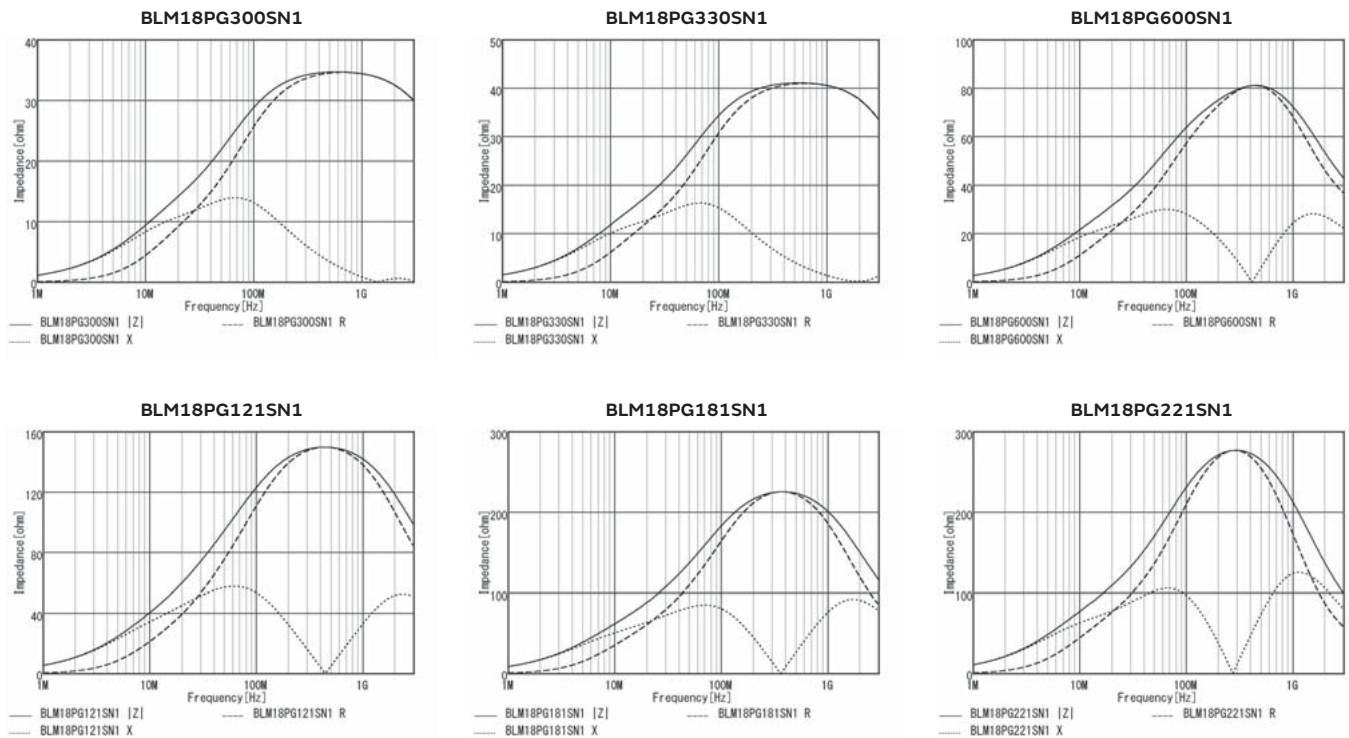

Continued on the following page. ↗

Continued from the preceding page. ↘

Z-f characteristics

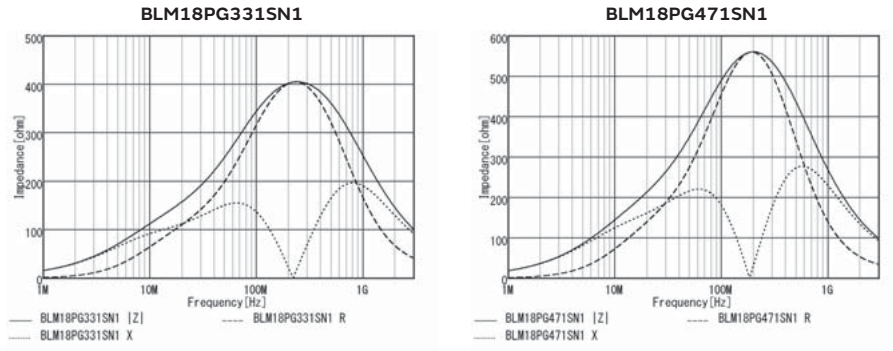

Derating of Rated Current

In operating temperature exceeding +85°C, derating of current is necessary for BLM18PG series.
 Please apply the derating curve shown in chart according to the operating temperature.

Derating of Rated Current

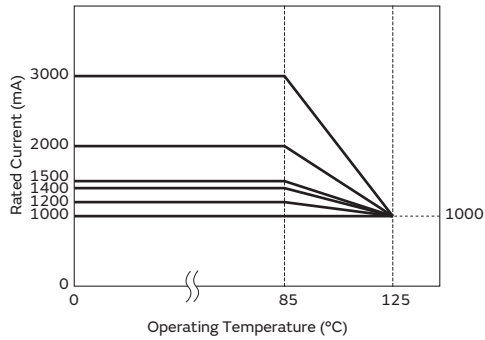

Chip ferrite bead

BLM18KG Series 0603/1608(inch/mm)

Appearance/Dimensions

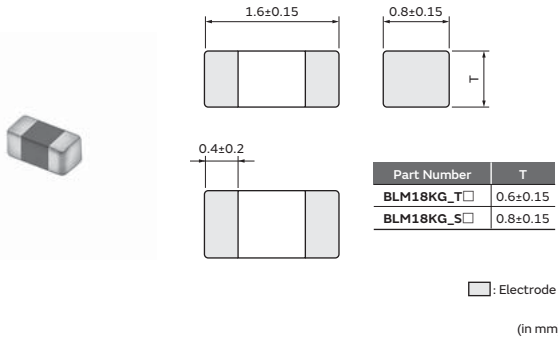

Packaging

| Code | Packaging | Minimum Quantity |
|------|-------------------|------------------|
| D | ø180mm Paper Tape | 4000 |
| J | ø330mm Paper Tape | 10000 |
| B | Bulk(Bag) | 1000 |

Equivalent Circuit



(Resistance element becomes dominant at high frequencies.)

Rated Value (□: packaging code)

| Part Number | Impedance at 100MHz | Rated Current at 85°C | Rated Current at 125°C | DC Resistance |
|----------------|---------------------|-----------------------|------------------------|---------------|
| BLM18KG221SN1□ | 220Ω±25% | 2.2A | 1.5A | 0.05Ω |
| BLM18KG331SN1□ | 330Ω±25% | 1.7A | 1.2A | 0.08Ω |
| BLM18KG471SN1□ | 470Ω±25% | 1.5A | 1A | 0.13Ω |
| BLM18KG601SN1□ | 600Ω±25% | 1.3A | 1A | 0.15Ω |
| BLM18KG102SN1□ | 1000Ω±25% | 1A | 800mA | 0.2Ω |
| BLM18KG260TN1□ | 26Ω±25% | 6A | 4A | 0.007Ω |
| BLM18KG300TN1□ | 30Ω±25% | 5A | 3.3A | 0.01Ω |
| BLM18KG700TN1□ | 70Ω±25% | 3.5A | 2.2A | 0.022Ω |
| BLM18KG101TN1□ | 100Ω±25% | 3A | 1.9A | 0.03Ω |
| BLM18KG121TN1□ | 120Ω±25% | 3A | 1.9A | 0.03Ω |

Operating Temp. Range: -55°C to 125°C

Z-f characteristics

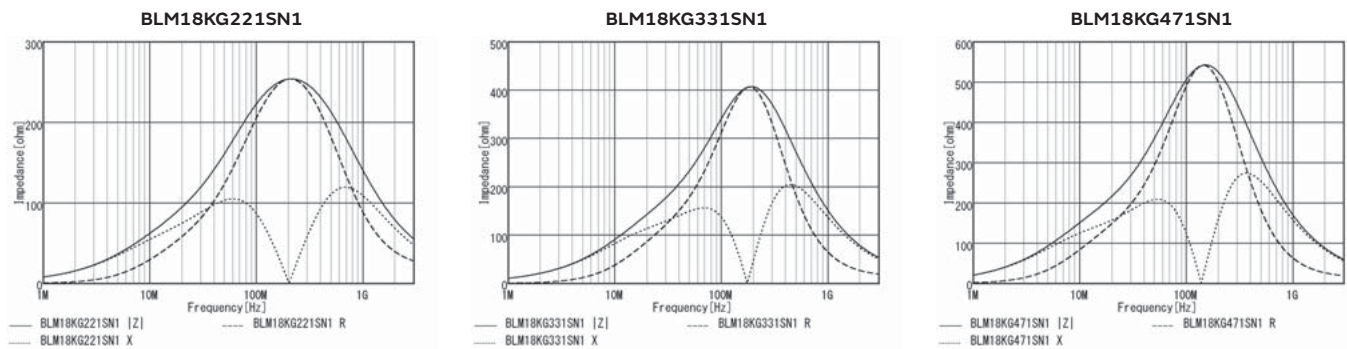

Continued on the following page. ↗

Continued from the preceding page. ↘

Z-f characteristics

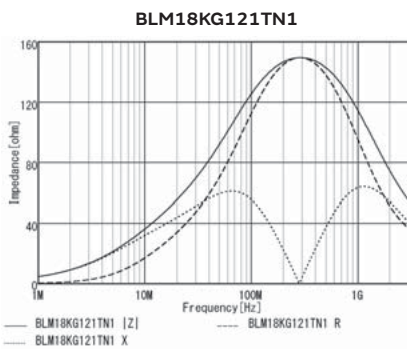
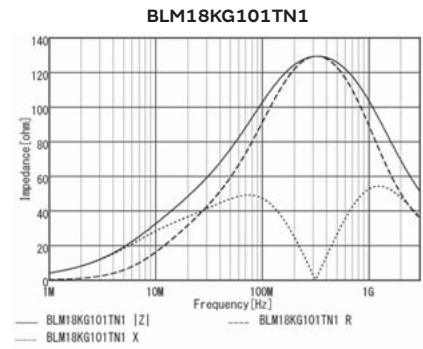
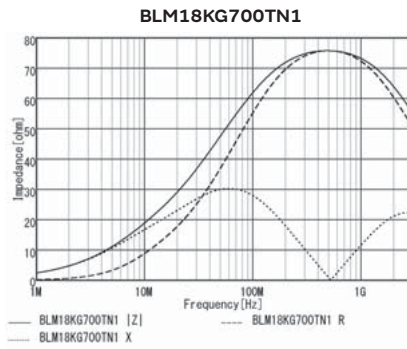
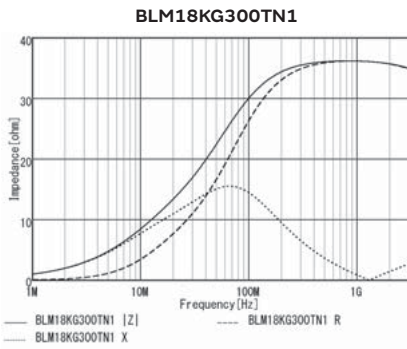
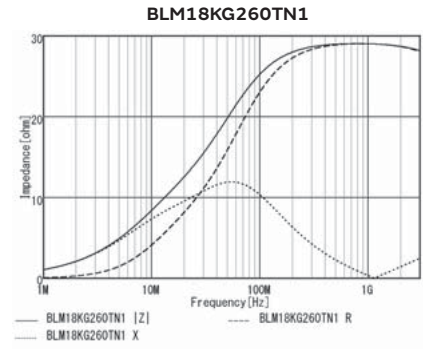
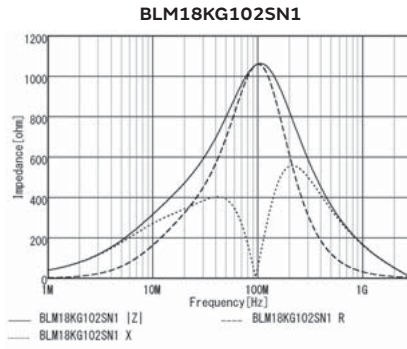
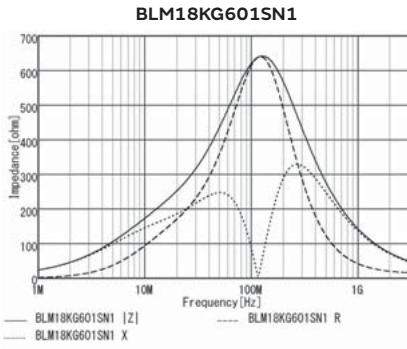

Derating of Rated Current

In operating temperature exceeding +85°C, derating of current is necessary for BLM18KG series. Please apply the derating curve shown in chart according to the operating temperature.

Derating of Rated Current

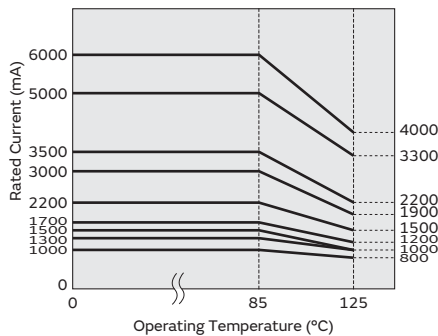

Chip ferrite bead

BLM18SD/SG/SN Series 0603/1608(inch/mm)

Appearance/Dimensions

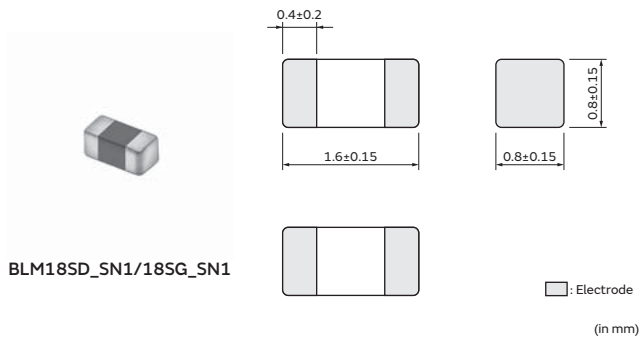

Packaging

| Code | Packaging | Minimum Quantity |
|------|-------------------|------------------|
| D | ø180mm Paper Tape | 4000 |
| J | ø330mm Paper Tape | 10000 |
| B | Bulk(Bag) | 1000 |

Equivalent Circuit

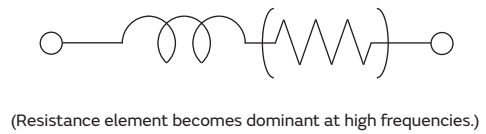

Appearance/Dimensions

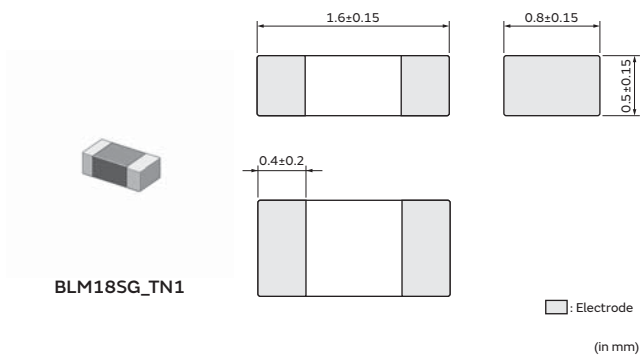

Packaging

| Code | Packaging | Minimum Quantity |
|------|-------------------|------------------|
| D | ø180mm Paper Tape | 10000 |
| J | ø330mm Paper Tape | 30000 |
| B | Bulk(Bag) | 1000 |

Equivalent Circuit

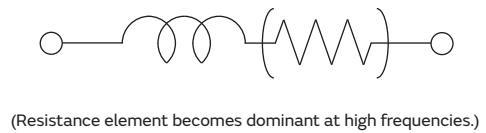

Appearance/Dimensions

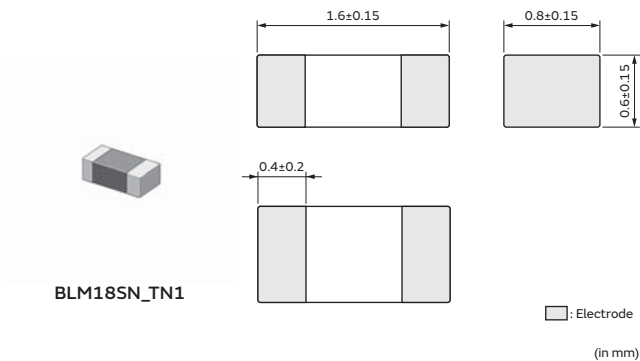

Packaging

| Code | Packaging | Minimum Quantity |
|------|-------------------|------------------|
| D | ø180mm Paper Tape | 4000 |
| B | Bulk(Bag) | 1000 |

Equivalent Circuit

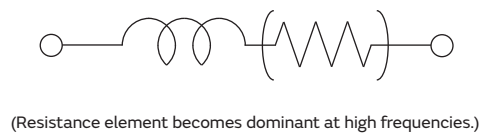

Rated Value (□: packaging code)

| Part Number | Impedance at 100MHz | Rated Current at 85°C | Rated Current at 125°C | DC Resistance |
|----------------|---------------------|-----------------------|------------------------|---------------|
| BLM18SD220SN1□ | 22Ω±25% | 6A | 3.5A | 0.008Ω |
| BLM18SG330SN1□ | 33Ω±25% | 6A | 3.5A | 0.008Ω |
| BLM18SG260TN1□ | 26Ω±25% | 6A | 1A | 0.007Ω |
| BLM18SG700TN1□ | 70Ω±25% | 4A | 1A | 0.02Ω |
| BLM18SG121TN1□ | 120Ω±25% | 3A | 1A | 0.025Ω |

Operating Temp. Range: -55°C to 125°C

Continued from the preceding page. ↘

| Part Number | Impedance at 100MHz | Rated Current at 85°C | Rated Current at 125°C | DC Resistance |
|----------------|---------------------|-----------------------|------------------------|---------------|
| BLM18SG221TN1□ | 220Ω±25% | 2.5A | 1A | 0.04Ω |
| BLM18SG331TN1□ | 330Ω±25% | 1.5A | 1A | 0.07Ω |
| BLM18SN220TN1□ | 22Ω±7% | 8A | 5A | 0.004Ω |

Operating Temp. Range: -55°C to 125°C

Z-f characteristics

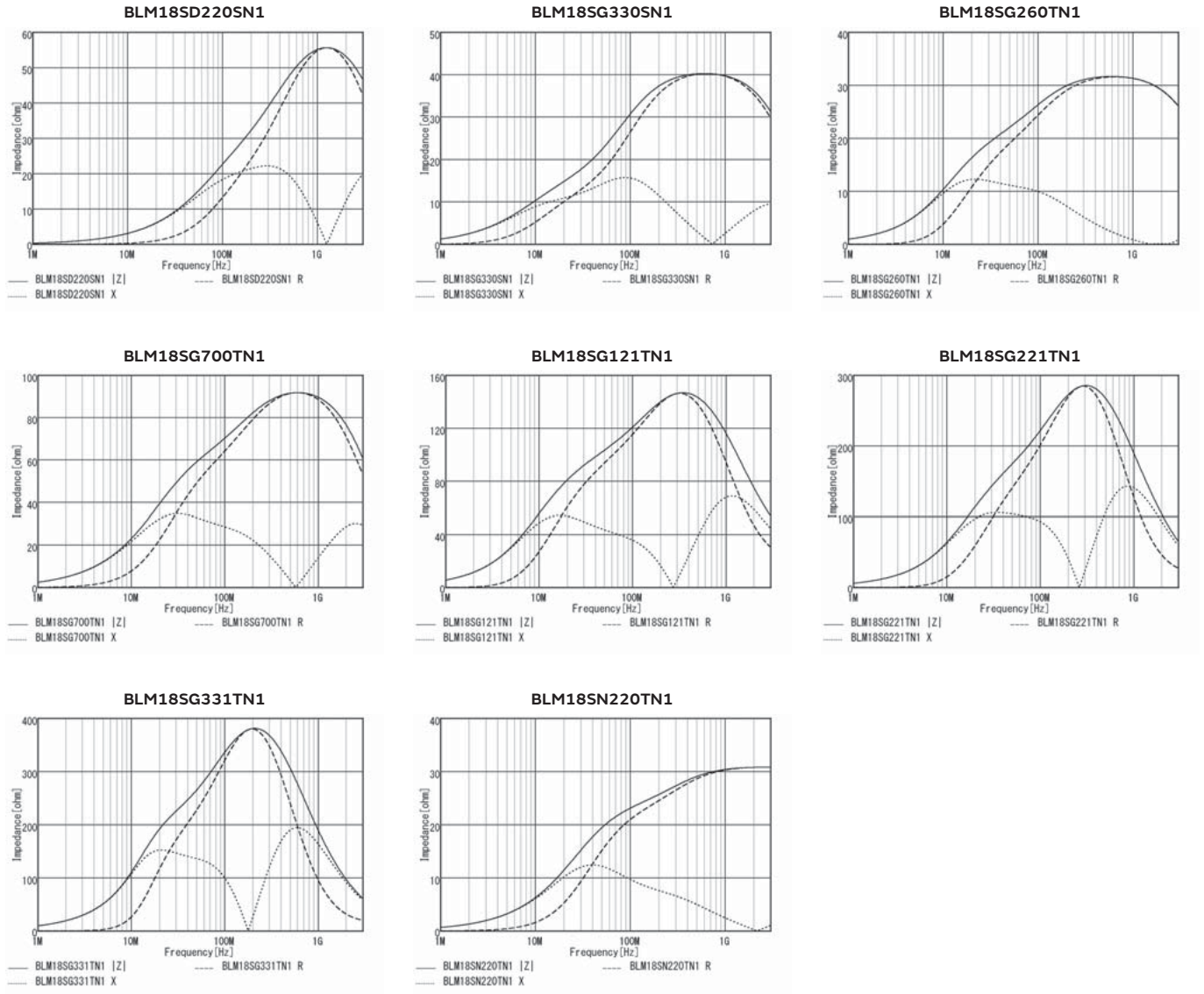

Continued on the following page. ↗

Chip Ferrite Bead

Application Specified Noise Filter

Chip EMIFIL®

Common Mode Choke Coil
 Common Mode Noise Filter

Block Type EMIFIL®

EMC Absorber

Continued from the preceding page. ↘

Derating of Rated Current

In operating temperature exceeding +85°C, derating of current is necessary for BLM18SD series. Please apply the derating curve shown in chart according to the operating temperature.

Derating of Rated Current

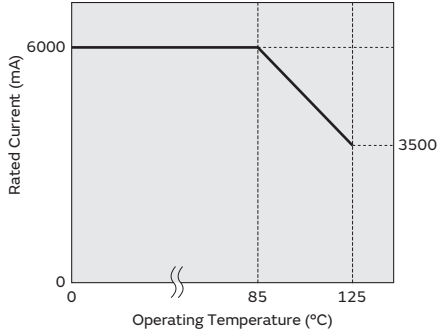

In operating temperature exceeding +85°C, derating of current is necessary for BLM18SG_S□1 series. Please apply the derating curve shown in chart according to the operating temperature.

Derating of Rated Current

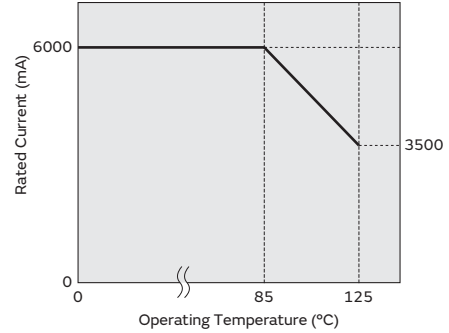

In operating temperature exceeding +85°C, derating of current is necessary for BLM18SG_T□1 series. Please apply the derating curve shown in chart according to the operating temperature.

Derating of Rated Current

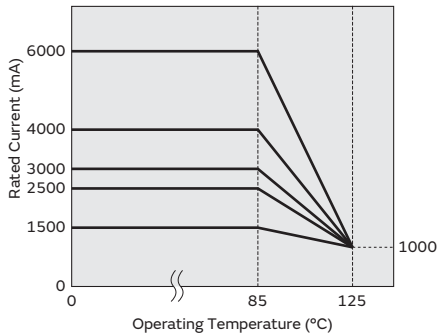

In operating temperature exceeding +85°C, derating of current is necessary for BLM18SN series. Please apply the derating curve shown in chart according to the operating temperature.

Derating of Rated Current

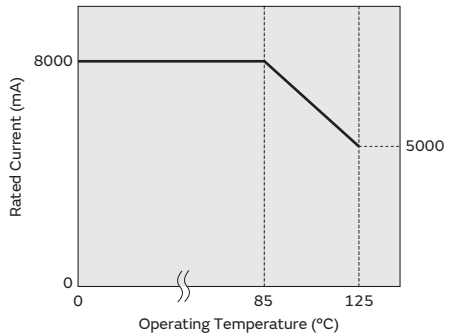

Chip ferrite bead

BLM18AG Series 0603/1608(inch/mm)

Appearance/Dimensions

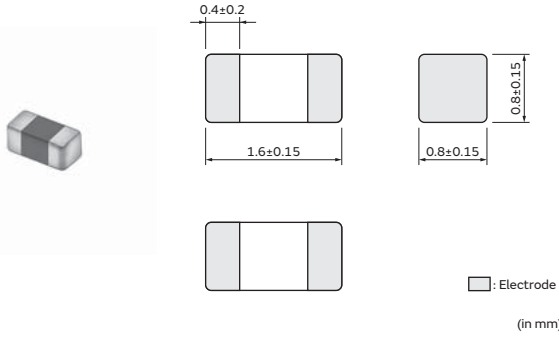

Packaging

| Code | Packaging | Minimum Quantity |
|------|-------------------|------------------|
| D | ø180mm Paper Tape | 4000 |
| J | ø330mm Paper Tape | 10000 |
| B | Bulk(Bag) | 1000 |

Equivalent Circuit



(Resistance element becomes dominant at high frequencies.)

Rated Value (□: packaging code)

| Part Number | Impedance at 100MHz | Rated Current at 85°C | Rated Current at 125°C | DC Resistance |
|----------------|---------------------|-----------------------|------------------------|---------------|
| BLM18AG121SN1□ | 120Ω±25% | 800mA | 800mA | 0.18Ω |
| BLM18AG151SN1□ | 150Ω±25% | 700mA | 700mA | 0.25Ω |
| BLM18AG221SN1□ | 220Ω±25% | 700mA | 700mA | 0.25Ω |
| BLM18AG331SN1□ | 330Ω±25% | 600mA | 600mA | 0.3Ω |
| BLM18AG471SN1□ | 470Ω±25% | 550mA | 550mA | 0.35Ω |
| BLM18AG601SN1□ | 600Ω±25% | 500mA | 500mA | 0.38Ω |
| BLM18AG102SN1□ | 1000Ω±25% | 450mA | 450mA | 0.5Ω |

Operating Temp. Range: -55°C to 125°C

Z-f characteristics

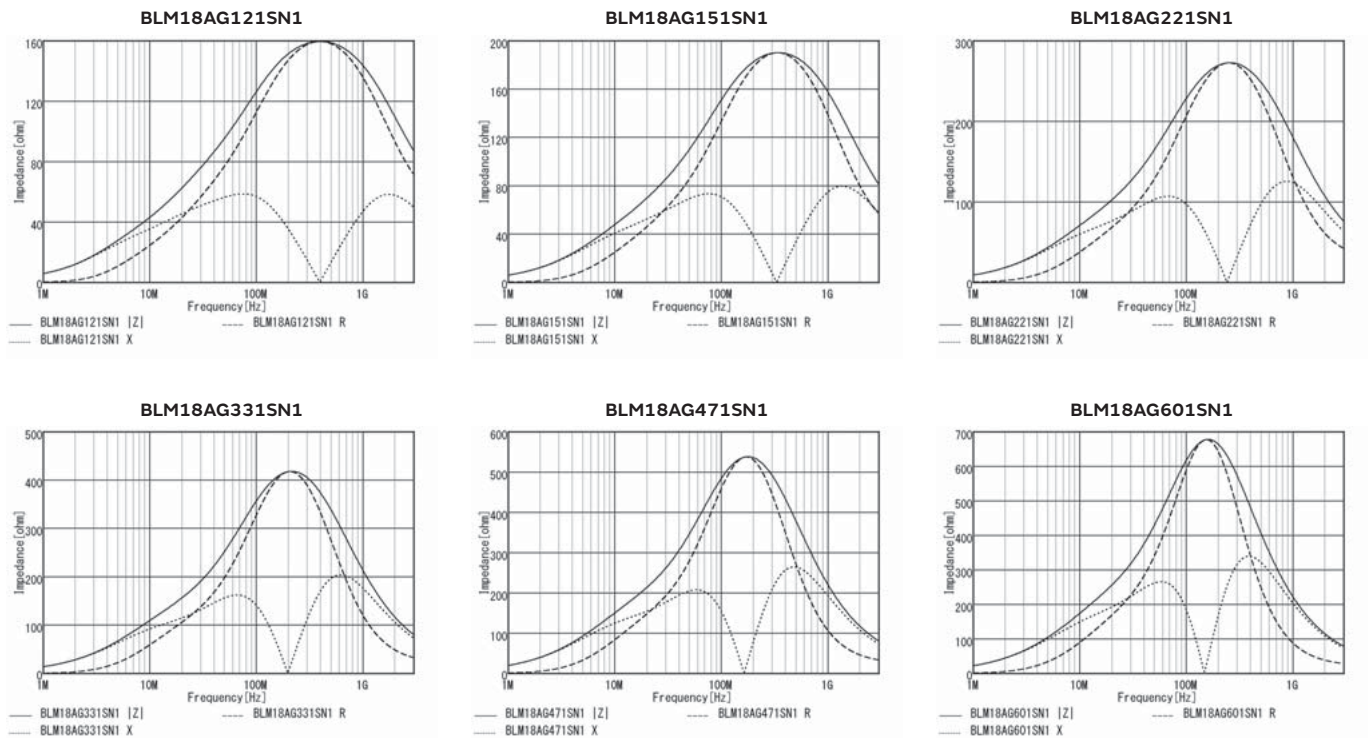

Continued on the following page. ↗

Continued from the preceding page. ↘

Z-f characteristics

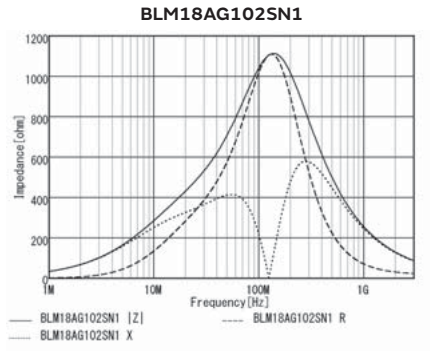

Chip ferrite bead

BLM18TG Series 0603/1608(inch/mm)

Appearance/Dimensions

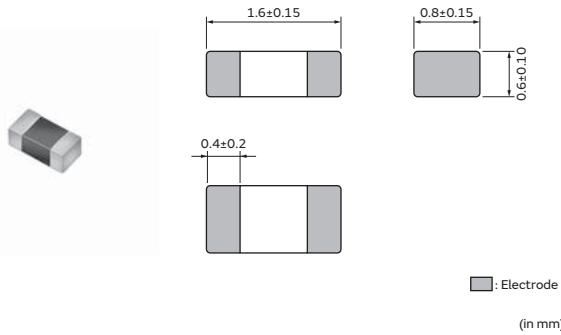

Packaging

| Code | Packaging | Minimum Quantity |
|------|-------------------|------------------|
| D | ø180mm Paper Tape | 10000 |
| B | Bulk(Bag) | 1000 |

Equivalent Circuit



(Resistance element becomes dominant at high frequencies.)

Rated Value (□: packaging code)

| Part Number | Impedance at 100MHz | Rated Current at 85°C | Rated Current at 125°C | DC Resistance |
|----------------|---------------------|-----------------------|------------------------|---------------|
| BLM18TG121TN1□ | 120Ω±25% | 200mA | 200mA | 0.25Ω |
| BLM18TG221TN1□ | 220Ω±25% | 200mA | 200mA | 0.3Ω |
| BLM18TG601TN1□ | 600Ω±25% | 200mA | 200mA | 0.45Ω |
| BLM18TG102TN1□ | 1000Ω±25% | 100mA | 100mA | 0.6Ω |

Operating Temp. Range: -55°C to 125°C

Z-f characteristics

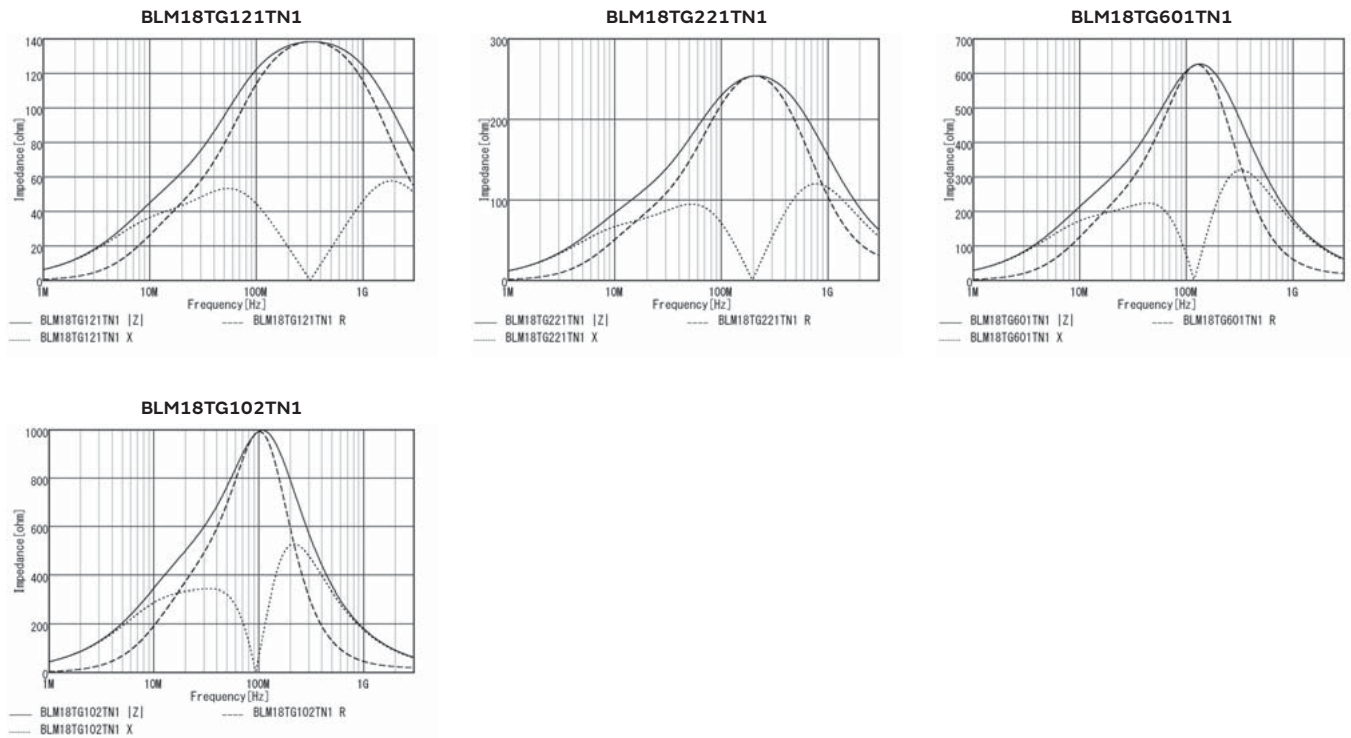

Chip ferrite bead

BLM18BA/BB/BD Series 0603/1608(inch/mm)

Appearance/Dimensions

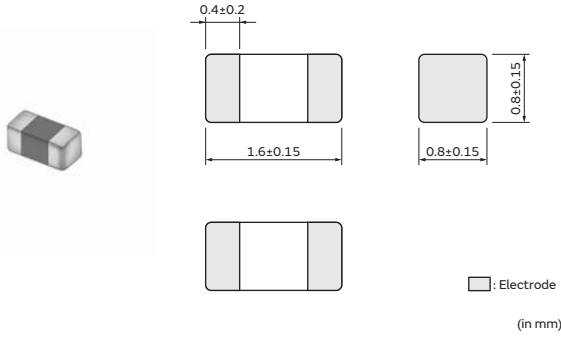

Packaging

| Code | Packaging | Minimum Quantity |
|------|-------------------|------------------|
| D | ø180mm Paper Tape | 4000 |
| J | ø330mm Paper Tape | 10000 |
| B | Bulk(Bag) | 1000 |

Equivalent Circuit



(Resistance element becomes dominant at high frequencies.)

Rated Value (□: packaging code)

| Part Number | Impedance at 100MHz | Rated Current at 85°C | Rated Current at 125°C | DC Resistance |
|----------------|---------------------|-----------------------|------------------------|---------------|
| BLM18BA050SN1□ | 5Ω±25% | 500mA | 500mA | 0.2Ω |
| BLM18BA100SN1□ | 10Ω±25% | 500mA | 500mA | 0.25Ω |
| BLM18BA220SN1□ | 22Ω±25% | 500mA | 500mA | 0.35Ω |
| BLM18BA470SN1□ | 47Ω±25% | 300mA | 300mA | 0.55Ω |
| BLM18BA750SN1□ | 75Ω±25% | 300mA | 300mA | 0.7Ω |
| BLM18BA121SN1□ | 120Ω±25% | 200mA | 200mA | 0.9Ω |
| BLM18BB050SN1□ | 5Ω±25% | 800mA | 800mA | 0.05Ω |
| BLM18BB100SN1□ | 10Ω±25% | 700mA | 700mA | 0.1Ω |
| BLM18BB220SN1□ | 22Ω±25% | 700mA | 700mA | 0.2Ω |
| BLM18BB470SN1□ | 47Ω±25% | 600mA | 600mA | 0.25Ω |
| BLM18BB600SN1□ | 60Ω±25% | 600mA | 600mA | 0.25Ω |
| BLM18BB750SN1□ | 75Ω±25% | 600mA | 600mA | 0.3Ω |
| BLM18BB121SN1□ | 120Ω±25% | 550mA | 550mA | 0.3Ω |
| BLM18BB141SN1□ | 140Ω±25% | 500mA | 500mA | 0.35Ω |
| BLM18BB151SN1□ | 150Ω±25% | 450mA | 450mA | 0.37Ω |
| BLM18BB221SN1□ | 220Ω±25% | 450mA | 450mA | 0.45Ω |
| BLM18BB331SN1□ | 330Ω±25% | 400mA | 400mA | 0.58Ω |
| BLM18BB471SN1□ | 470Ω±25% | 300mA | 300mA | 0.85Ω |
| BLM18BD470SN1□ | 47Ω±25% | 500mA | 500mA | 0.3Ω |
| BLM18BD121SN1□ | 120Ω±25% | 300mA | 300mA | 0.4Ω |
| BLM18BD151SN1□ | 150Ω±25% | 300mA | 300mA | 0.4Ω |
| BLM18BD221SN1□ | 220Ω±25% | 250mA | 250mA | 0.45Ω |
| BLM18BD331SN1□ | 330Ω±25% | 250mA | 250mA | 0.5Ω |
| BLM18BD421SN1□ | 420Ω±25% | 250mA | 250mA | 0.55Ω |
| BLM18BD471SN1□ | 470Ω±25% | 250mA | 250mA | 0.55Ω |
| BLM18BD601SN1□ | 600Ω±25% | 200mA | 200mA | 0.65Ω |
| BLM18BD102SN1□ | 1000Ω±25% | 200mA | 200mA | 0.85Ω |
| BLM18BD152SN1□ | 1500Ω±25% | 150mA | 150mA | 1.2Ω |
| BLM18BD182SN1□ | 1800Ω±25% | 150mA | 150mA | 1.5Ω |
| BLM18BD222SN1□ | 2200Ω±25% | 150mA | 150mA | 1.5Ω |
| BLM18BD252SN1□ | 2500Ω±25% | 150mA | 150mA | 1.5Ω |

Operating Temp. Range: -55°C to 125°C

Continued on the following page. ↗

Continued from the preceding page. ↘

Z-f characteristics

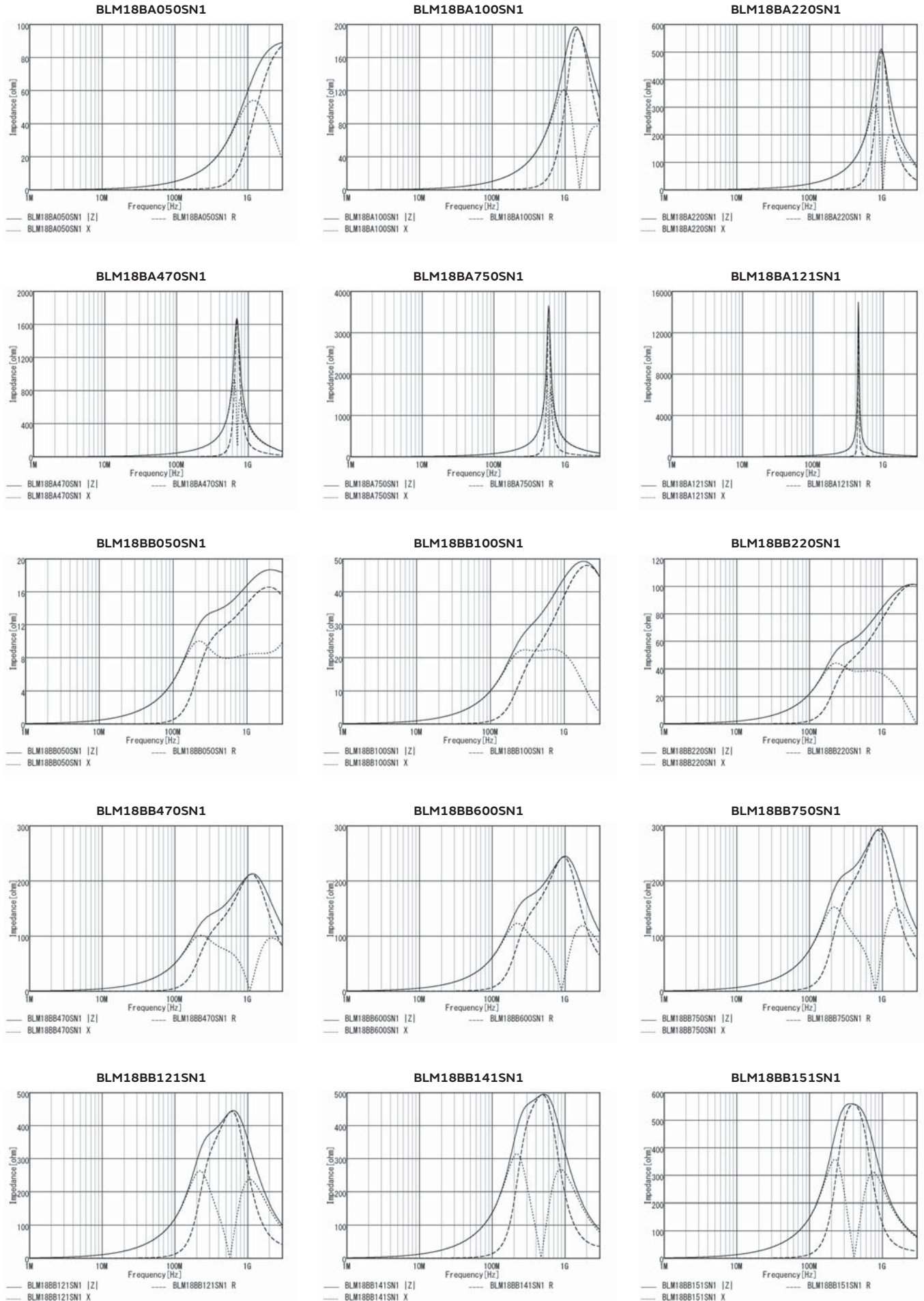

Chip Ferrite Bead

Application Specified Noise Filter

Chip EMIFIL®

Common Mode Choke Coil
 Common Mode Noise Filter

Block Type EMIFIL®

EMC Absorber

Continued from the preceding page. ↘

Z-f characteristics

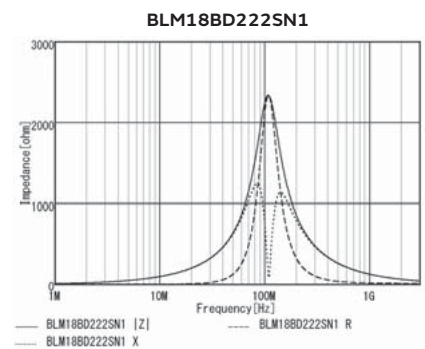
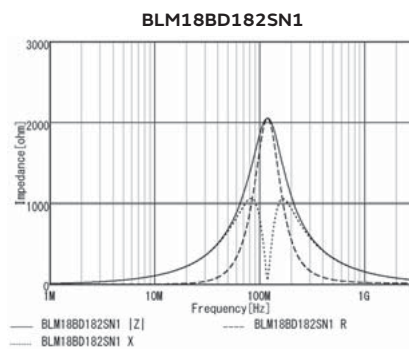
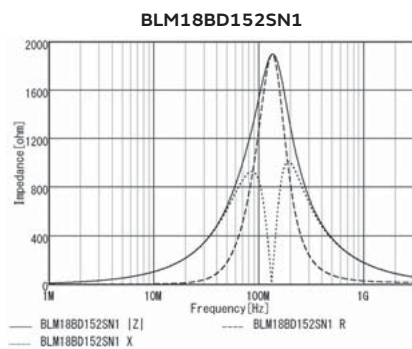
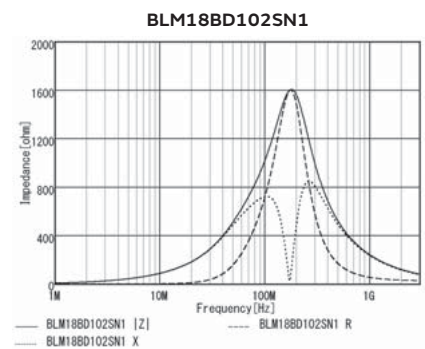
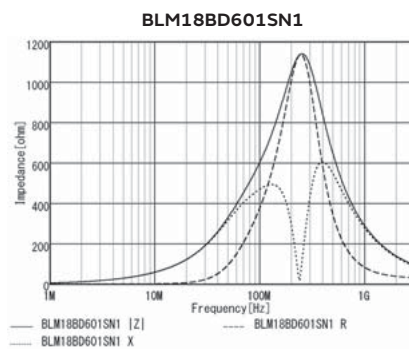
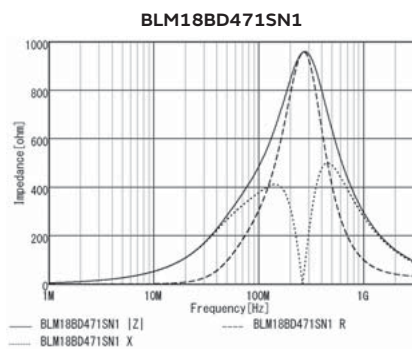
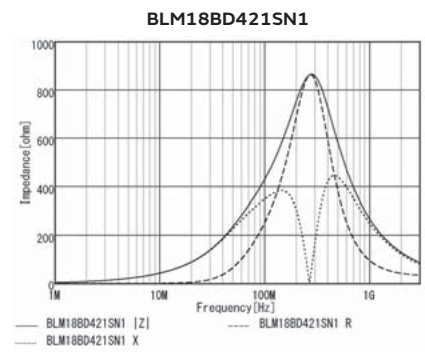
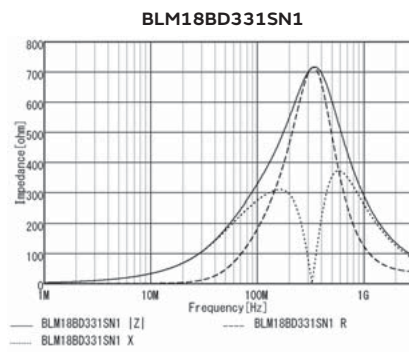
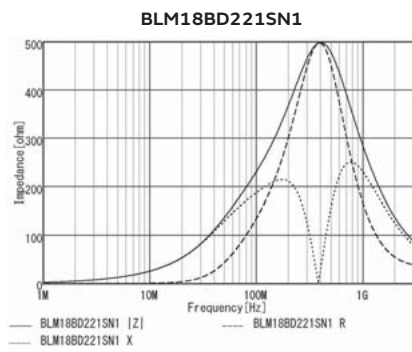
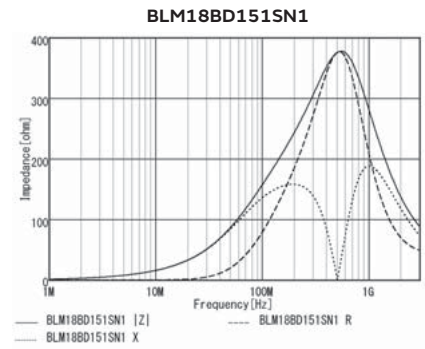
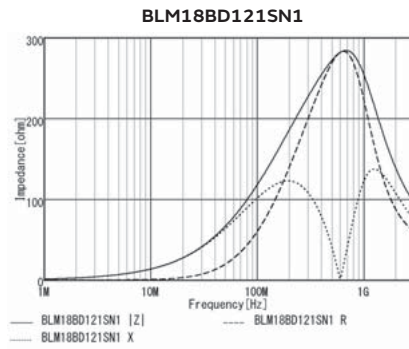
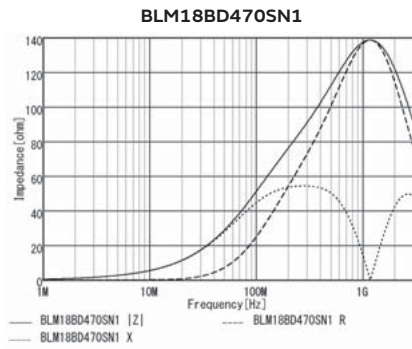
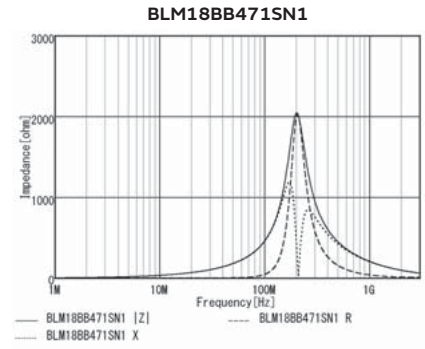
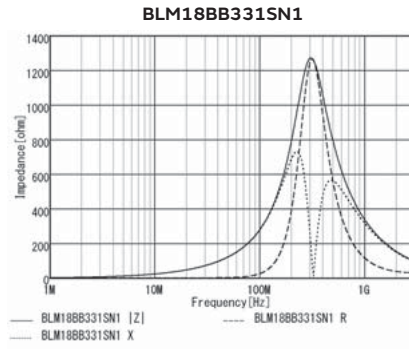
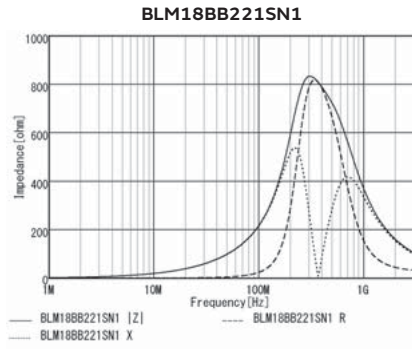

Continued from the preceding page. ↘

Z-f characteristics

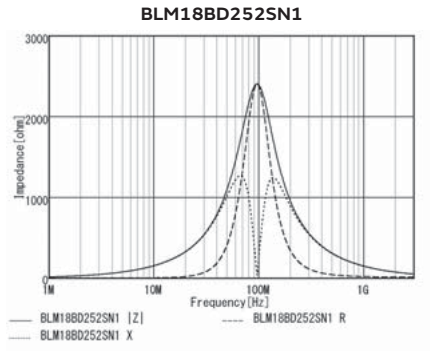

Chip Ferrite Bead

Application Specified Noise Filter

Chip EMIFIL®

Common Mode Choke Coil
Common Mode Noise Filter

Block Type EMIFIL®

EMC Absorber

Chip ferrite bead

BLM18RK Series 0603/1608(inch/mm)

Appearance/Dimensions

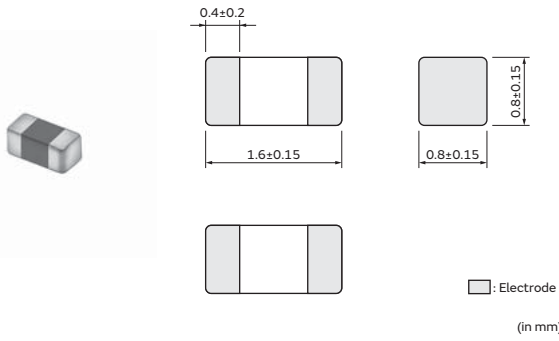

Packaging

| Code | Packaging | Minimum Quantity |
|------|-------------------|------------------|
| D | ø180mm Paper Tape | 4000 |
| J | ø330mm Paper Tape | 10000 |
| B | Bulk(Bag) | 1000 |

Equivalent Circuit



(Resistance element becomes dominant at high frequencies.)

Rated Value (□: packaging code)

| Part Number | Impedance at 100MHz | Rated Current at 85°C | Rated Current at 125°C | DC Resistance |
|----------------|---------------------|-----------------------|------------------------|---------------|
| BLM18RK121SN1□ | 120Ω±25% | 200mA | 200mA | 0.25Ω |
| BLM18RK221SN1□ | 220Ω±25% | 200mA | 200mA | 0.3Ω |
| BLM18RK471SN1□ | 470Ω±25% | 200mA | 200mA | 0.5Ω |
| BLM18RK601SN1□ | 600Ω±25% | 200mA | 200mA | 0.6Ω |
| BLM18RK102SN1□ | 1000Ω±25% | 200mA | 200mA | 0.8Ω |

Operating Temp. Range: -55°C to 125°C

Z-f characteristics

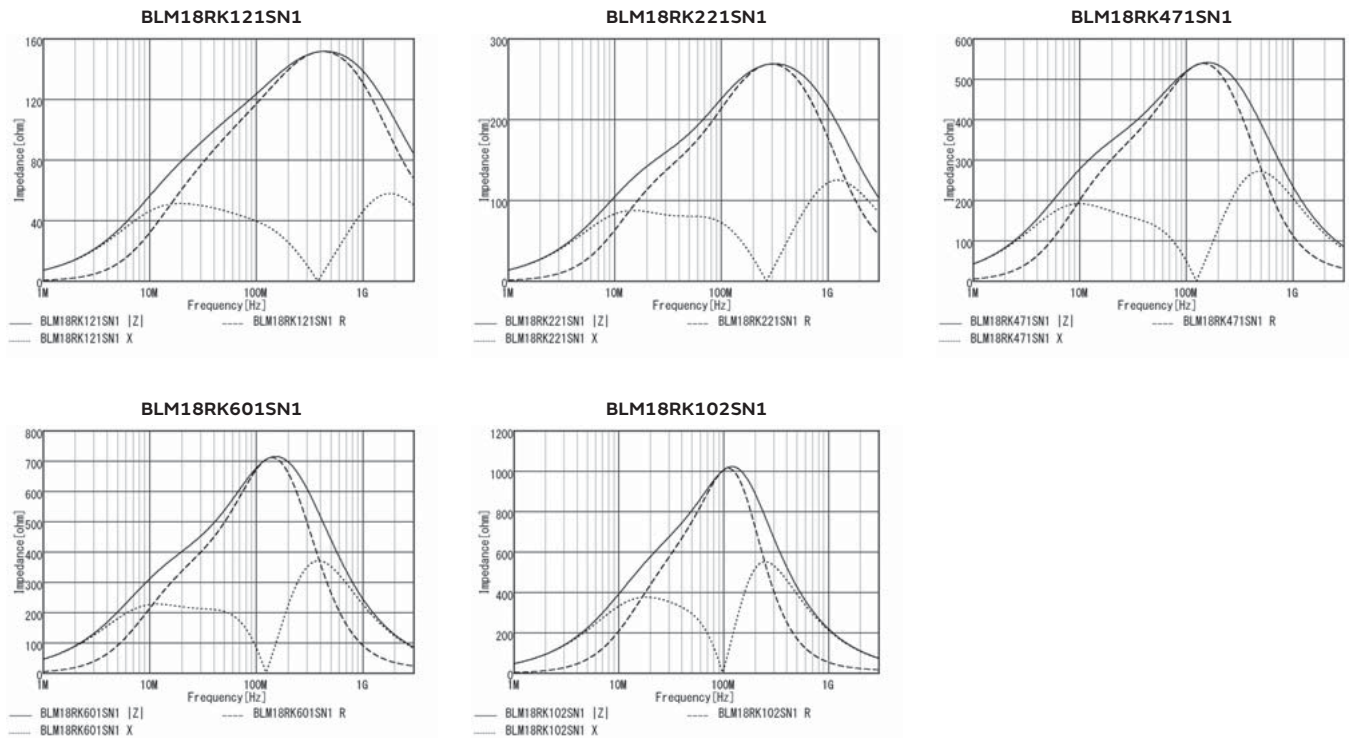

Chip Ferrite Bead (BLM□□R Series) EMI Suppression Effect

Waveform Distortion Suppressing Performance of BLM□□R Series

Measuring Circuits

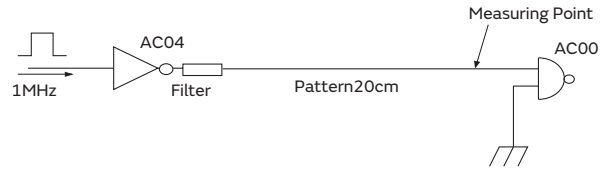

| Type of Filter | EMI Suppression Effect / Description | | |
|--|--|------------------------------------|-----------------|
| Initial (No filter) | <p>Signal waveform (100nsec/div, 2V/div)</p> | <p>Expand (10nsec/div, 2V/div)</p> | <p>Spectrum</p> |
| Resistor (47Ω) is used | <p>Signal waveform (100nsec/div, 2V/div)</p> | <p>Expand (10nsec/div, 2V/div)</p> | <p>Spectrum</p> |
| BLM18RK221SN1 (220Ω at 100MHz) is used | <p>Signal waveform (100nsec/div, 2V/div)</p> | <p>Expand (10nsec/div, 2V/div)</p> | <p>Spectrum</p> |

Ringing is caused on the signal waveform.
 Such ringing contains several hundred MHz harmonic components and generates noise.

Comparing initial waveform, ringing is suppressed a little.
 However, high level waveform distortion still remains.

BLM18R has excellent performance for noise suppression and waveform distortion suppression.
 BLM18R suppresses drastically not only the spectrum level in more than 100MHz range but waveform distortion.

Chip Ferrite Bead

Application Specified Noise Filter

Chip EMIFIL®

Common Mode Choke Coil
 Common Mode Noise Filter

Block Type EMIFIL®

EMC Absorber

Chip ferrite bead

BLM21PG Series 0805/2012(inch/mm)

Appearance/Dimensions

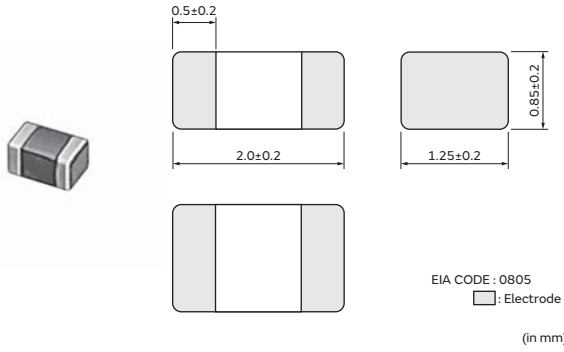

Packaging

| Code | Packaging | Minimum Quantity |
|------|-------------------|------------------|
| D | ø180mm Paper Tape | 4000 |
| J | ø330mm Paper Tape | 10000 |
| B | Bulk(Bag) | 1000 |

Equivalent Circuit



(Resistance element becomes dominant at high frequencies.)

Rated Value (□: packaging code)

| Part Number | Impedance at 100MHz | Rated Current at 85°C | Rated Current at 125°C | DC Resistance |
|----------------|---------------------|-----------------------|------------------------|---------------|
| BLM21PG220SN1□ | 22Ω±25% | 6A | 3.3A | 0.009Ω |
| BLM21PG300SN1□ | 30Ω(Typ.) | 4A | 2.3A | 0.014Ω |
| BLM21PG600SN1□ | 60Ω±25% | 3.5A | 1.9A | 0.02Ω |
| BLM21PG121SN1□ | 120Ω±25% | 3A | 1.55A | 0.03Ω |
| BLM21PG221SN1□ | 220Ω±25% | 2A | 1.25A | 0.045Ω |
| BLM21PG331SN1□ | 330Ω±25% | 1.5A | 1A | 0.07Ω |

Operating Temp. Range: -55°C to 125°C

Z-f characteristics

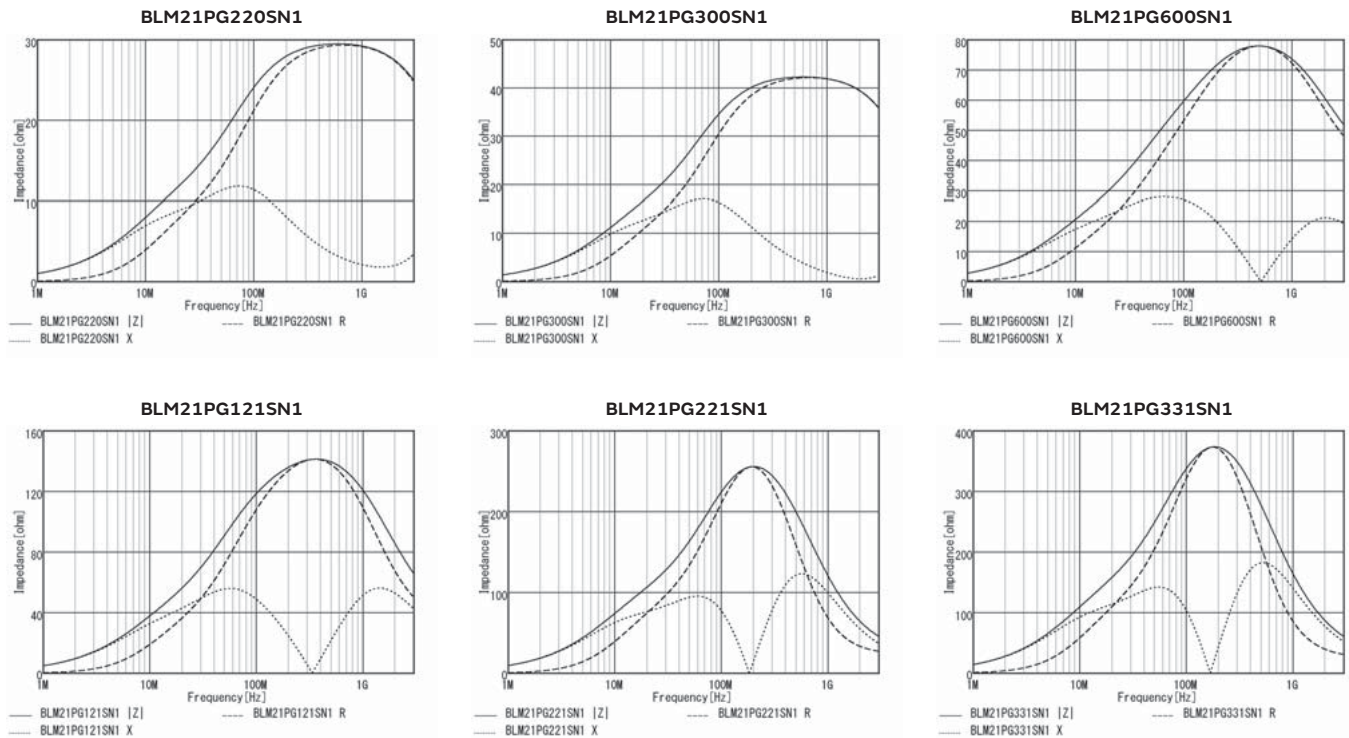

Continued on the following page. ↗

Continued from the preceding page. ↘

Derating of Rated Current

In operating temperature exceeding +85°C, derating of current is necessary for BLM21PG series.
 Please apply the derating curve shown in chart according to the operating temperature.

Derating of Rated Current

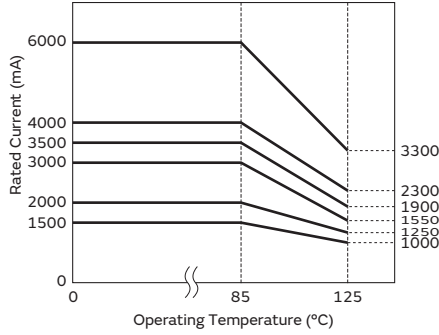

Chip ferrite bead

BLM21SN/SP Series 0805/2012(inch/mm)

Appearance/Dimensions

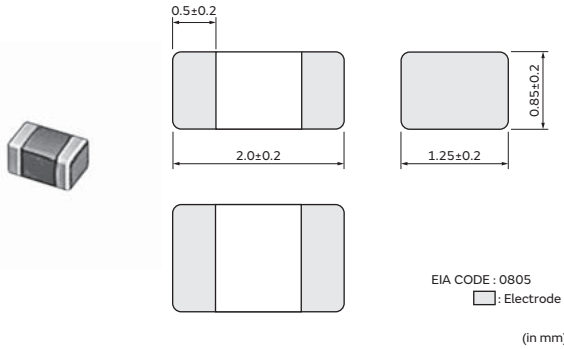

Packaging

| Code | Packaging | Minimum Quantity |
|------|-------------------|------------------|
| D | ø180mm Paper Tape | 4000 |
| J | ø330mm Paper Tape | 10000 |
| B | Bulk(Bag) | 1000 |

Equivalent Circuit



(Resistance element becomes dominant at high frequencies.)

Rated Value (□: packaging code)

| Part Number | Impedance at 100MHz | Rated Current at 85°C | Rated Current at 125°C | DC Resistance |
|----------------|---------------------|-----------------------|------------------------|---------------|
| BLM21SN300SN1□ | 30Ω±10Ω | 8.5A | 6A | 0.004Ω |
| BLM21SP700SN1□ | 70Ω±25% | 6A | 4A | 0.009Ω |
| BLM21SP111SN1□ | 110Ω±25% | 5A | 3.3A | 0.013Ω |
| BLM21SP181SN1□ | 180Ω±25% | 4A | 2.6A | 0.02Ω |
| BLM21SP331SN1□ | 330Ω±25% | 2.8A | 1.9A | 0.04Ω |
| BLM21SP471SN1□ | 470Ω±25% | 2.5A | 1.7A | 0.05Ω |
| BLM21SP601SN1□ | 600Ω±25% | 2.3A | 1.5A | 0.06Ω |
| BLM21SP102SN1□ | 1000Ω±25% | 1.6A | 1.1A | 0.12Ω |

Operating Temp. Range: -55°C to 125°C

Z-f characteristics

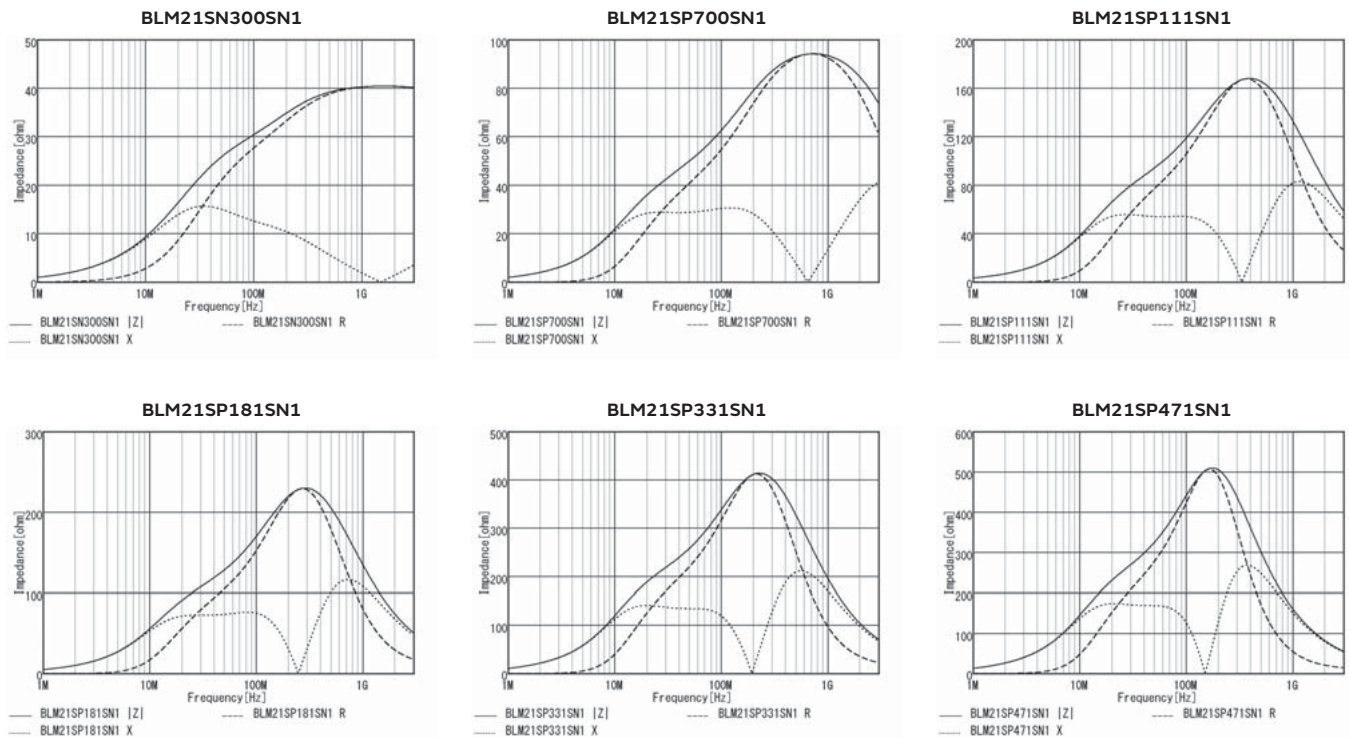

Continued on the following page. ↗

Continued from the preceding page. ↘

Z-f characteristics

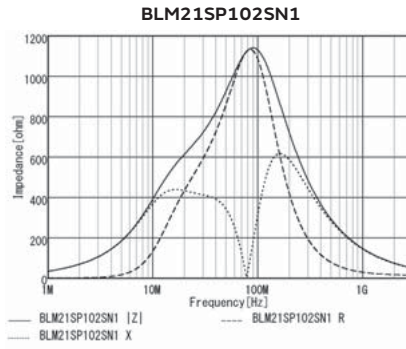
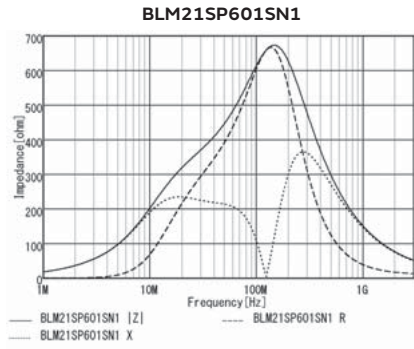

Derating of Rated Current

In operating temperature exceeding +85°C, derating of current is necessary for BLM21SN series. Please apply the derating curve shown in chart according to the operating temperature.

Derating of Rated Current

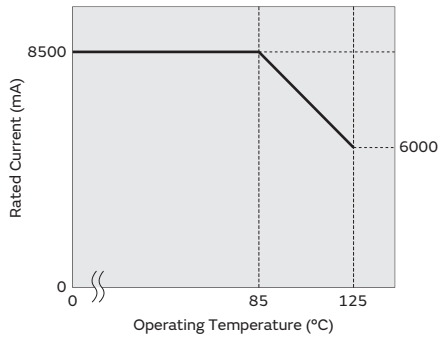

In operating temperature exceeding +85°C, derating of current is necessary for BLM21SP series. Please apply the derating curve shown in chart according to the operating temperature.

Derating of Rated Current

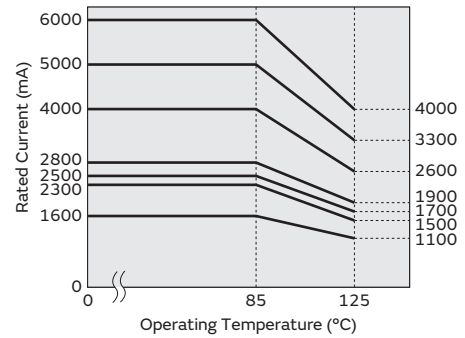

Chip ferrite bead

BLM21AG Series 0805/2012(inch/mm)

Appearance/Dimensions

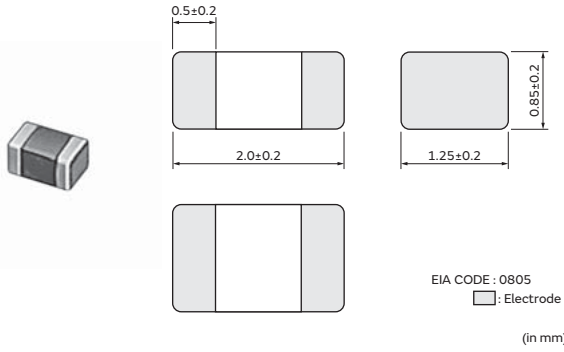

Packaging

| Code | Packaging | Minimum Quantity |
|------|-------------------|------------------|
| D | ø180mm Paper Tape | 4000 |
| J | ø330mm Paper Tape | 10000 |
| B | Bulk(Bag) | 1000 |

Equivalent Circuit



(Resistance element becomes dominant at high frequencies.)

Rated Value (□: packaging code)

| Part Number | Impedance at 100MHz | Rated Current at 85°C | Rated Current at 125°C | DC Resistance |
|----------------|---------------------|-----------------------|------------------------|---------------|
| BLM21AG121SN1□ | 120Ω±25% | 1A | 1A | 0.09Ω |
| BLM21AG151SN1□ | 150Ω±25% | 1A | 1A | 0.09Ω |
| BLM21AG221SN1□ | 220Ω±25% | 900mA | 900mA | 0.12Ω |
| BLM21AG331SN1□ | 330Ω±25% | 800mA | 800mA | 0.15Ω |
| BLM21AG471SN1□ | 470Ω±25% | 700mA | 700mA | 0.18Ω |
| BLM21AG601SN1□ | 600Ω±25% | 700mA | 700mA | 0.2Ω |
| BLM21AG102SN1□ | 1000Ω±25% | 600mA | 600mA | 0.27Ω |

Operating Temp. Range: -55°C to 125°C

Z-f characteristics

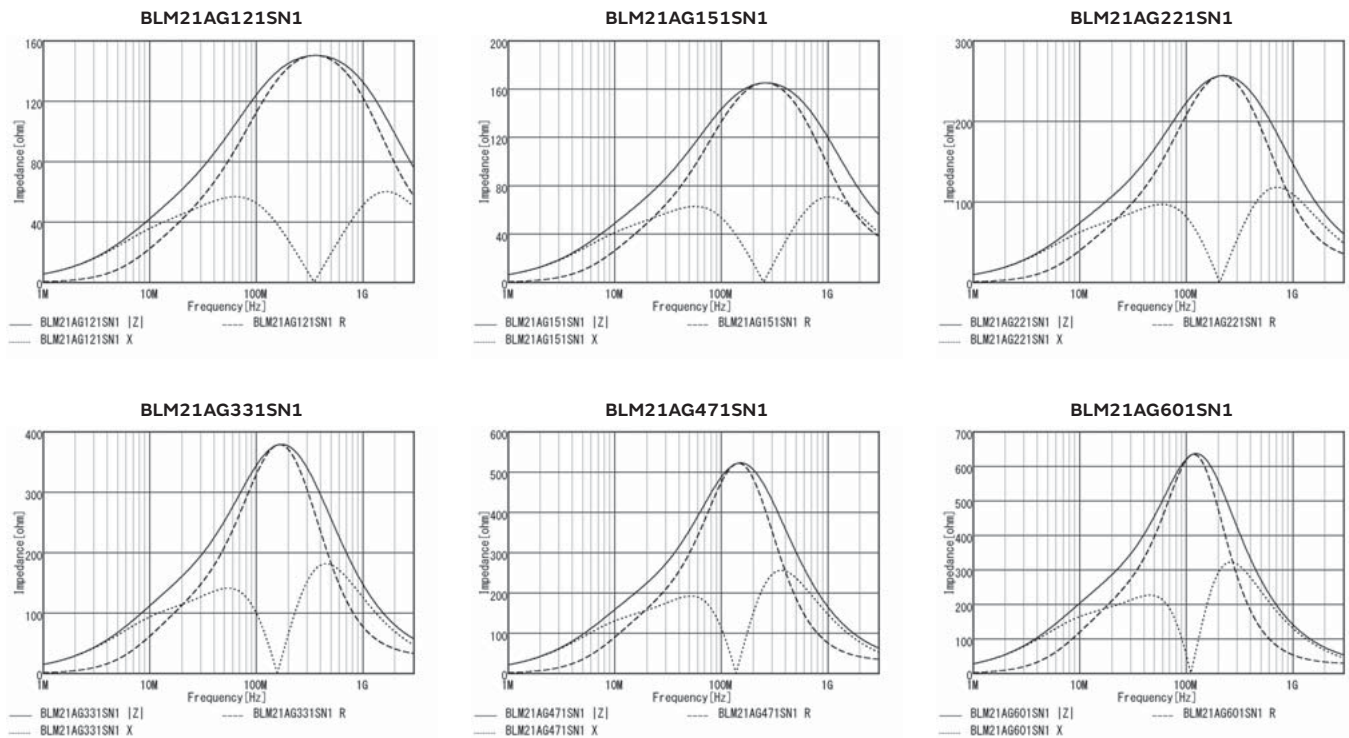

Continued on the following page. ↗

Continued from the preceding page. ↘

Z-f characteristics

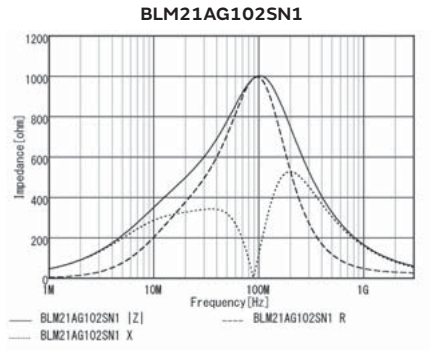

Chip Ferrite Bead

Application Specified Noise Filter

Chip EMIFIL®

Common Mode Choke Coil
Common Mode Noise Filter

Block Type EMIFIL®

EMC Absorber

Chip ferrite bead

BLM21BB/BD Series 0805/2012(inch/mm)

Appearance/Dimensions

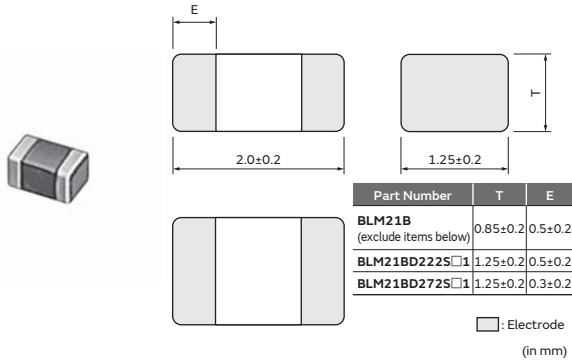

Packaging

All except for BLM21BD222SN1/BLM21BD272SN1

| Code | Packaging | Minimum Quantity |
|------|-------------------|------------------|
| D | ø180mm Paper Tape | 4000 |
| J | ø330mm Paper Tape | 10000 |
| B | Bulk(Bag) | 1000 |

BLM21BD222SN1/BLM21BD272SN1 only

| Code | Packaging | Minimum Quantity |
|------|----------------------|------------------|
| K | ø330mm Embossed Tape | 10000 |
| L | ø180mm Embossed Tape | 3000 |
| B | Bulk(Bag) | 1000 |

Equivalent Circuit



(Resistance element becomes dominant at high frequencies.)

Rated Value (□: packaging code)

| Part Number | Impedance at 100MHz | Rated Current at 85°C | Rated Current at 125°C | DC Resistance |
|----------------|---------------------|-----------------------|------------------------|---------------|
| BLM21BB050SN1□ | 5Ω±25% | 1A | 1A | 0.02Ω |
| BLM21BB600SN1□ | 60Ω±25% | 800mA | 800mA | 0.13Ω |
| BLM21BB750SN1□ | 75Ω±25% | 700mA | 700mA | 0.16Ω |
| BLM21BB121SN1□ | 120Ω±25% | 600mA | 600mA | 0.19Ω |
| BLM21BB151SN1□ | 150Ω±25% | 600mA | 600mA | 0.21Ω |
| BLM21BB201SN1□ | 200Ω±25% | 500mA | 500mA | 0.26Ω |
| BLM21BB221SN1□ | 220Ω±25% | 500mA | 500mA | 0.26Ω |
| BLM21BB331SN1□ | 330Ω±25% | 400mA | 400mA | 0.33Ω |
| BLM21BB471SN1□ | 470Ω±25% | 400mA | 400mA | 0.4Ω |
| BLM21BD121SN1□ | 120Ω±25% | 350mA | 350mA | 0.25Ω |
| BLM21BD151SN1□ | 150Ω±25% | 350mA | 350mA | 0.25Ω |
| BLM21BD221SN1□ | 220Ω±25% | 350mA | 350mA | 0.25Ω |
| BLM21BD331SN1□ | 330Ω±25% | 300mA | 300mA | 0.3Ω |
| BLM21BD421SN1□ | 420Ω±25% | 300mA | 300mA | 0.3Ω |
| BLM21BD471SN1□ | 470Ω±25% | 300mA | 300mA | 0.35Ω |
| BLM21BD601SN1□ | 600Ω±25% | 300mA | 300mA | 0.35Ω |
| BLM21BD751SN1□ | 750Ω±25% | 250mA | 250mA | 0.4Ω |
| BLM21BD102SN1□ | 1000Ω±25% | 250mA | 250mA | 0.4Ω |
| BLM21BD152SN1□ | 1500Ω±25% | 250mA | 250mA | 0.45Ω |
| BLM21BD182SN1□ | 1800Ω±25% | 250mA | 250mA | 0.5Ω |
| BLM21BD222SN1□ | 2250Ω(Typ.) | 250mA | 250mA | 0.6Ω |
| BLM21BD272SN1□ | 2700Ω±25% | 200mA | 200mA | 0.8Ω |
| BLM21BD222TN1□ | 2200Ω±25% | 200mA | 200mA | 0.6Ω |

Operating Temp. Range: -55°C to 125°C

Continued on the following page. ↗

Continued from the preceding page. ↘

Z-f characteristics

BLM21BB050SN1

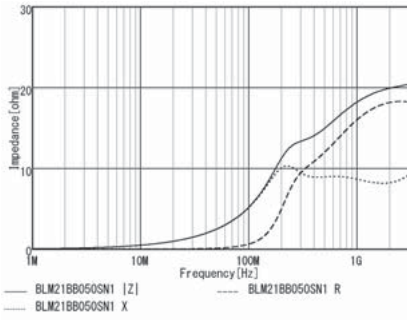

BLM21BB600SN1

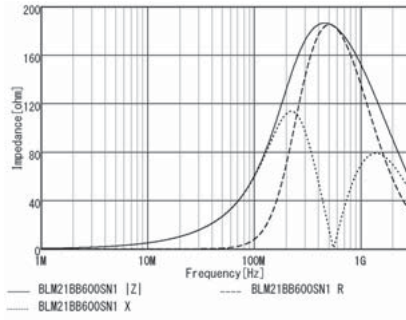

BLM21BB750SN1

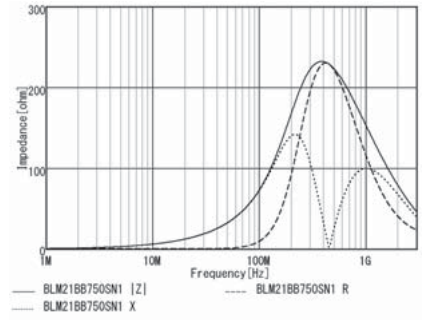

BLM21BB121SN1

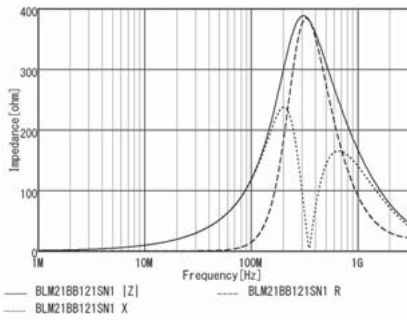

BLM21BB151SN1

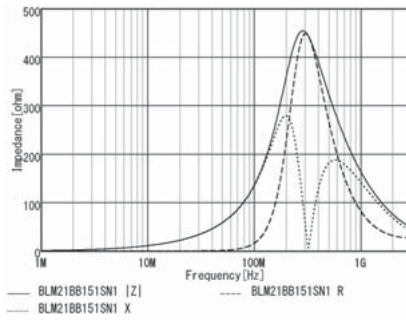

BLM21BB201SN1

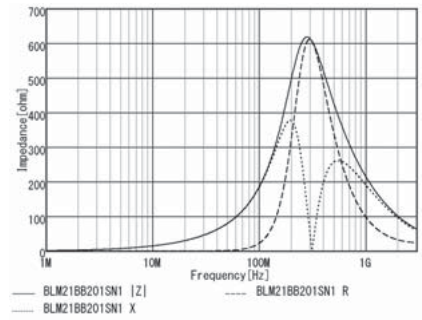

BLM21BB221SN1

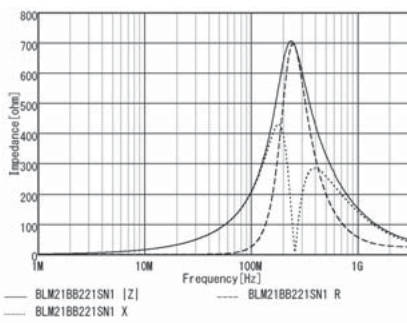

BLM21BB331SN1

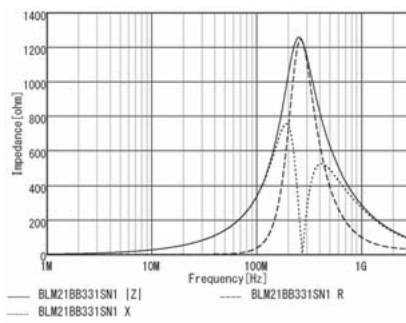

BLM21BB471SN1

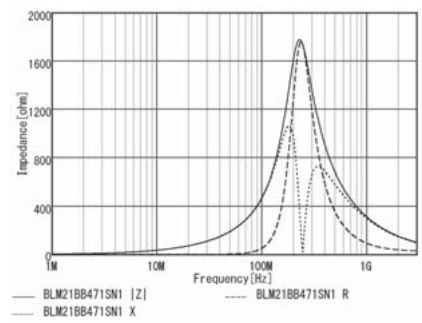

BLM21BD121SN1

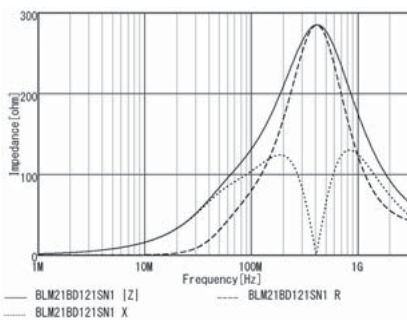

BLM21BD151SN1

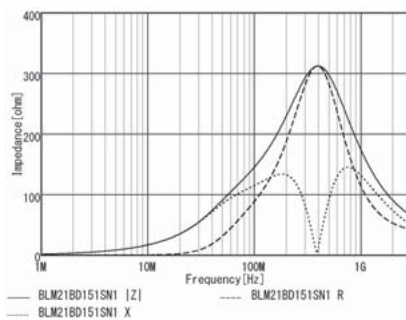

BLM21BD221SN1

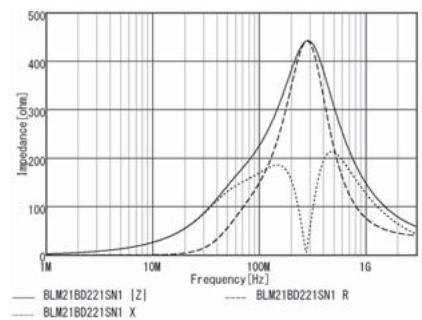

BLM21BD331SN1

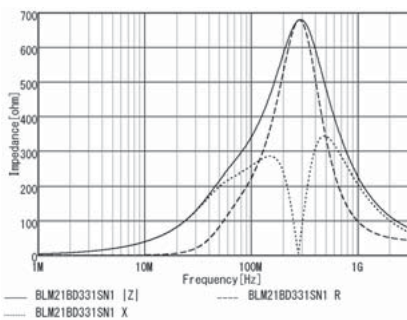

BLM21BD421SN1

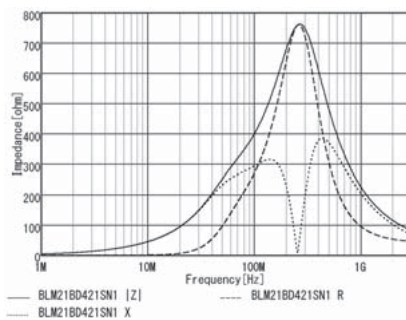

BLM21BD471SN1

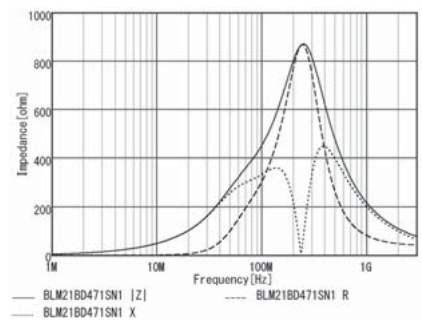

Chip Ferrite Bead

Application Specified Noise Filter

Chip EMIFIL®

Common Mode Choke Coil
 Common Mode Noise Filter

Block Type EMIFIL®

EMC Absorber

Continued from the preceding page. ↘

Z-f characteristics

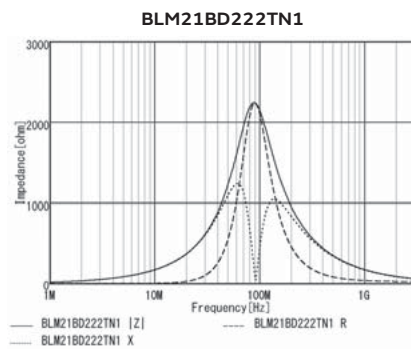
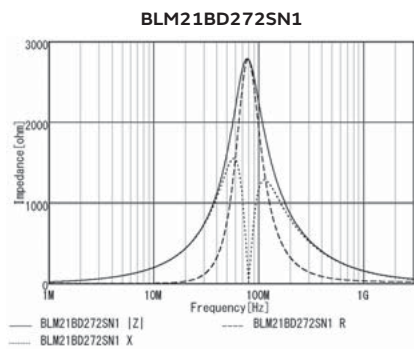
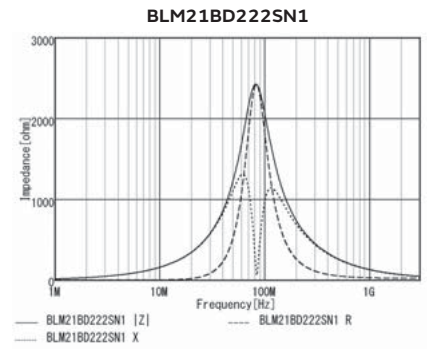
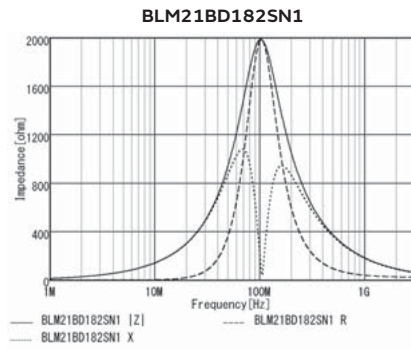
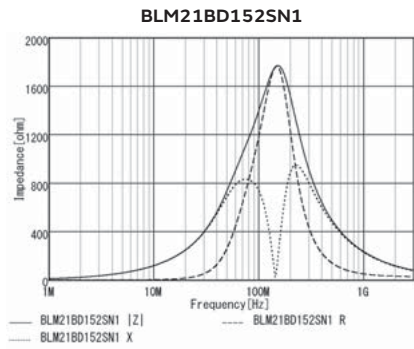
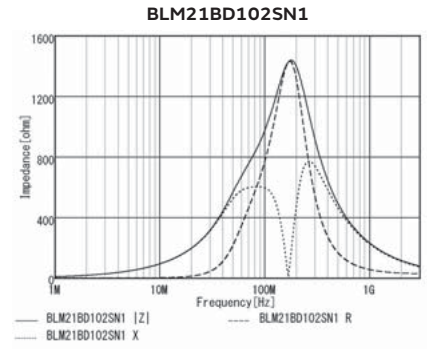
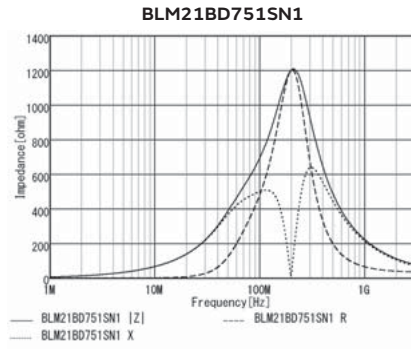
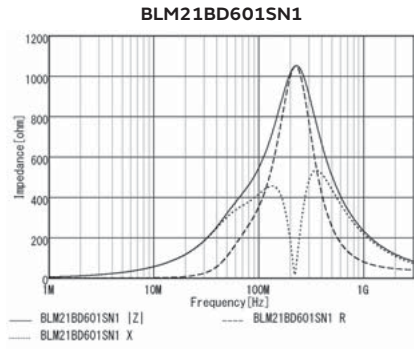

Chip ferrite bead

BLM21RK Series 0805/2012(inch/mm)

Appearance/Dimensions

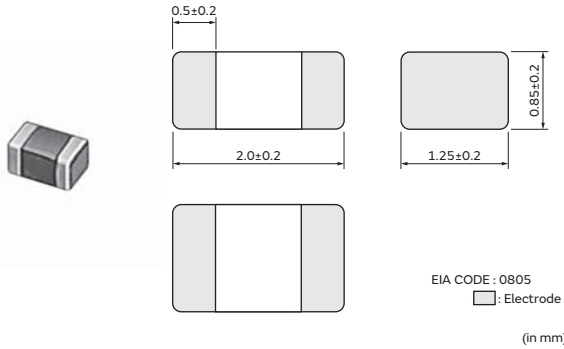

Packaging

| Code | Packaging | Minimum Quantity |
|------|-------------------|------------------|
| D | ø180mm Paper Tape | 4000 |
| J | ø330mm Paper Tape | 10000 |
| B | Bulk(Bag) | 1000 |

Equivalent Circuit



(Resistance element becomes dominant at high frequencies.)

Rated Value (□: packaging code)

| Part Number | Impedance at 100MHz | Rated Current at 85°C | Rated Current at 125°C | DC Resistance |
|----------------|---------------------|-----------------------|------------------------|---------------|
| BLM21RK121SN1□ | 120Ω±25% | 200mA | 200mA | 0.15Ω |
| BLM21RK221SN1□ | 220Ω±25% | 200mA | 200mA | 0.2Ω |
| BLM21RK471SN1□ | 470Ω±25% | 200mA | 200mA | 0.25Ω |
| BLM21RK601SN1□ | 600Ω±25% | 200mA | 200mA | 0.3Ω |
| BLM21RK102SN1□ | 1000Ω±25% | 200mA | 200mA | 0.5Ω |

Operating Temp. Range: -55°C to 125°C

Z-f characteristics

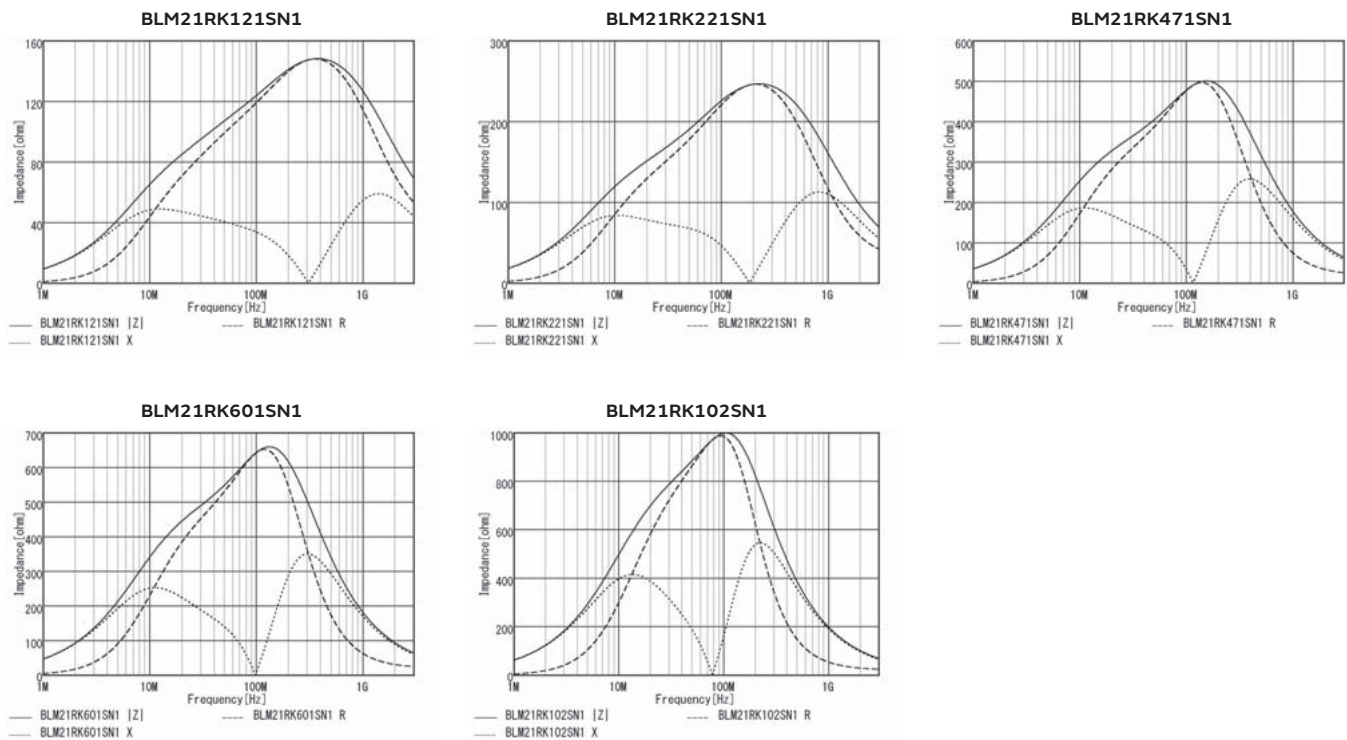

Chip ferrite bead

BLM31KN Series 1206/3216(inch/mm)

Appearance/Dimensions

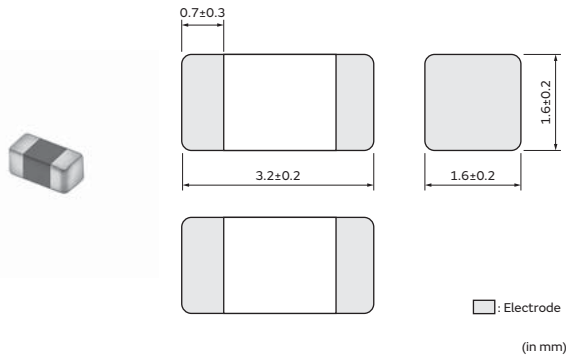

Packaging

| Code | Packaging | Minimum Quantity |
|------|----------------------|------------------|
| K | ø330mm Embossed Tape | 8000 |
| L | ø180mm Embossed Tape | 2500 |
| B | Bulk(Bag) | 1000 |

Equivalent Circuit



(Resistance element becomes dominant at high frequencies.)

Rated Value (□: packaging code)

| Part Number | Impedance at 100MHz | Rated Current at 85°C | Rated Current at 125°C | DC Resistance |
|----------------|---------------------|-----------------------|------------------------|---------------|
| BLM31KN121SN1□ | 120Ω±25% | 6A | 4A | 0.009Ω |
| BLM31KN271SN1□ | 270Ω±25% | 4.5A | 3A | 0.016Ω |
| BLM31KN471SN1□ | 470Ω±25% | 4A | 2.7A | 0.02Ω |
| BLM31KN601SN1□ | 600Ω±25% | 2.9A | 2A | 0.038Ω |
| BLM31KN801SN1□ | 800Ω±25% | 2.5A | 1.7A | 0.05Ω |
| BLM31KN102SN1□ | 1000Ω±25% | 2A | 1.4A | 0.075Ω |

Operating Temp. Range: -55°C to 125°C

Z-f characteristics

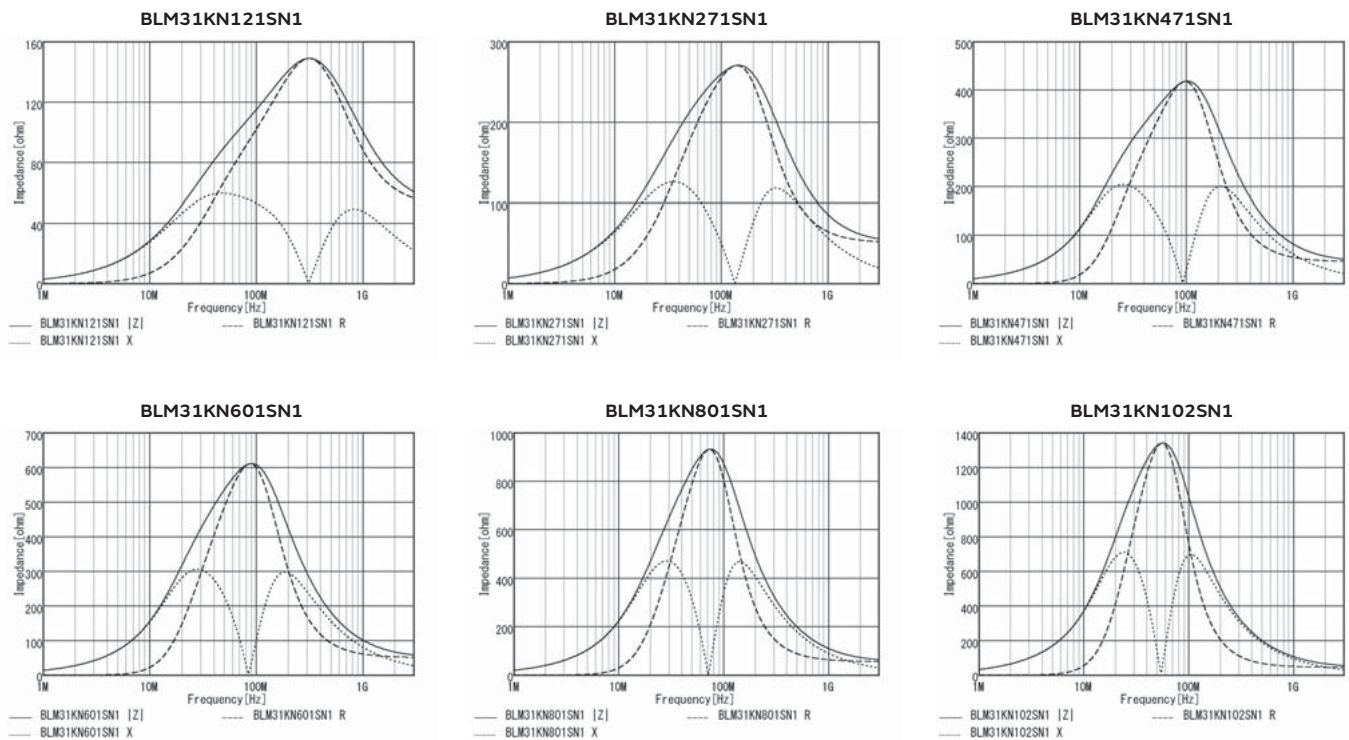

Continued on the following page. ↗

Continued from the preceding page. ↘

Derating of Rated Current

In operating temperature exceeding +85°C, derating of current is necessary for BLM31KN series.
 Please apply the derating curve shown in chart according to the operating temperature.

Derating of Rated Current

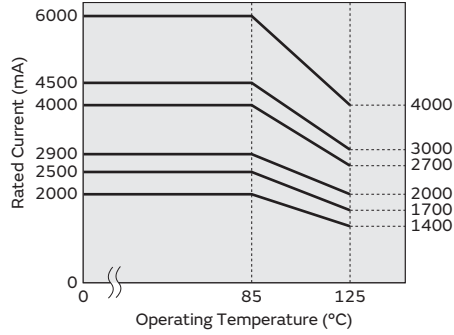

Chip Ferrite Bead

Application Specified Noise Filter

Chip EMIFIL®

Common Mode Choke Coil
 Common Mode Noise Filter

Block Type EMIFIL®

EMC Absorber

Chip ferrite bead

BLM31PG Series 1206/3216(inch/mm)

Appearance/Dimensions

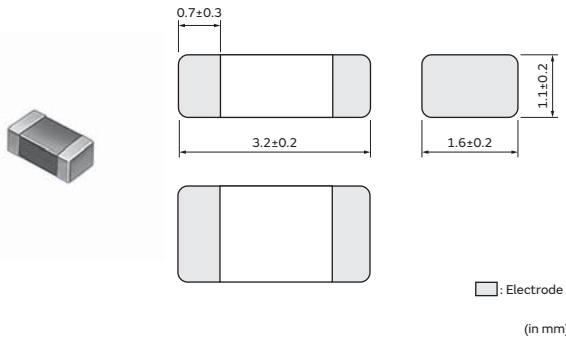

Packaging

| Code | Packaging | Minimum Quantity |
|------|----------------------|------------------|
| K | ø330mm Embossed Tape | 10000 |
| L | ø180mm Embossed Tape | 3000 |
| B | Bulk(Bag) | 1000 |

Equivalent Circuit



(Resistance element becomes dominant at high frequencies.)

Rated Value (□: packaging code)

| Part Number | Impedance at 100MHz | Rated Current at 85°C | Rated Current at 125°C | DC Resistance |
|----------------|---------------------|-----------------------|------------------------|---------------|
| BLM31PG330SN1□ | 33Ω±25% | 6A | 3.5A | 0.009Ω |
| BLM31PG500SN1□ | 50Ω(Typ.) | 3.5A | 2.3A | 0.015Ω |
| BLM31PG121SN1□ | 120Ω±25% | 3.5A | 2A | 0.02Ω |
| BLM31PG391SN1□ | 390Ω±25% | 2A | 1.25A | 0.05Ω |
| BLM31PG601SN1□ | 600Ω±25% | 1.5A | 1A | 0.08Ω |

Operating Temp. Range: -55°C to 125°C

Z-f characteristics

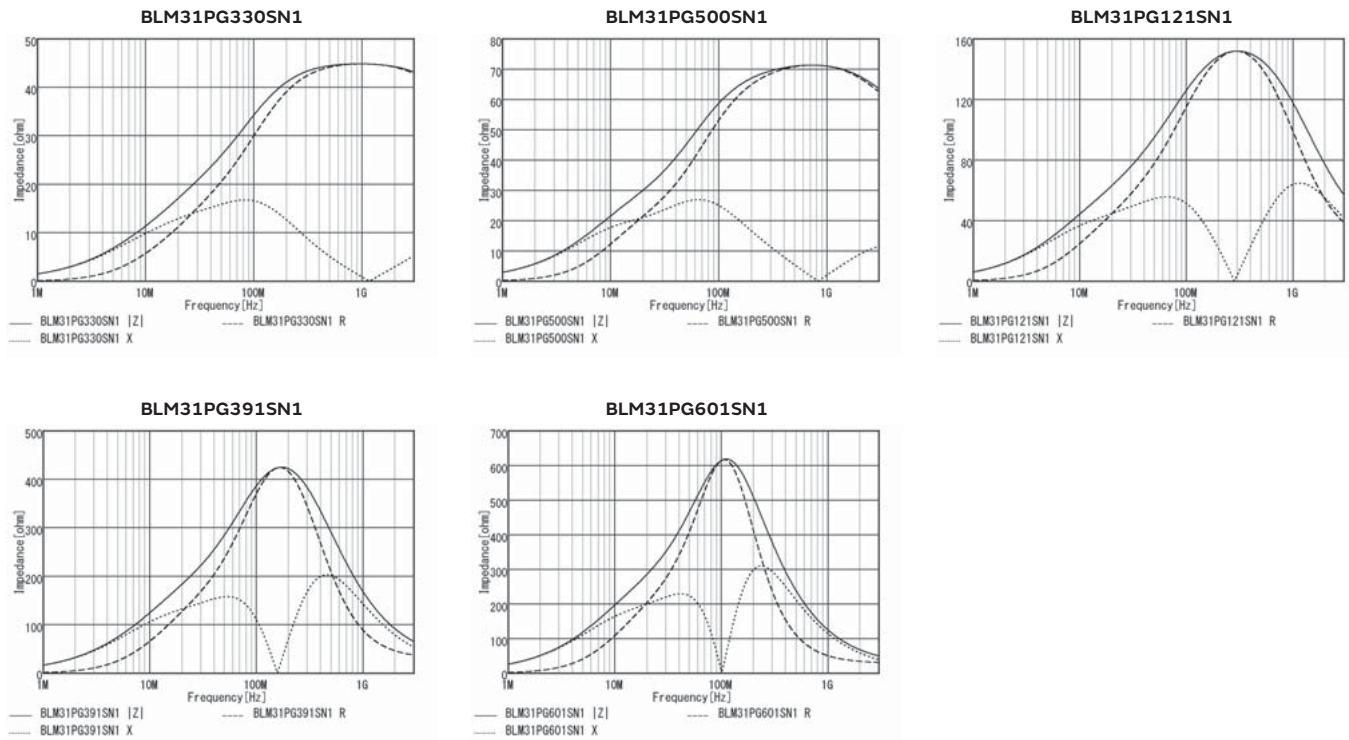

Continued on the following page. ↗

Continued from the preceding page. ↘

Derating of Rated Current

In operating temperature exceeding +85°C, derating of current is necessary for BLM31PG series.
 Please apply the derating curve shown in chart according to the operating temperature.

Derating of Rated Current

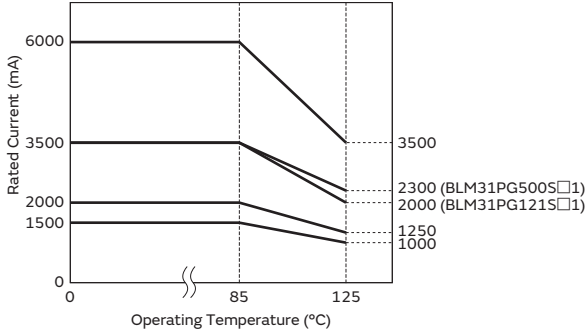

Chip ferrite bead

BLM31SN Series 1206/3216(inch/mm)

Appearance/Dimensions

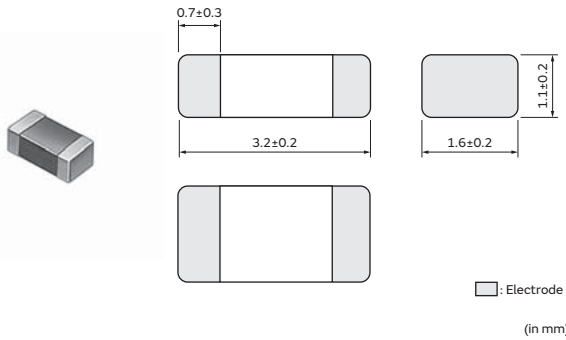

Packaging

| Code | Packaging | Minimum Quantity |
|------|----------------------|------------------|
| L | ø180mm Embossed Tape | 3000 |
| B | Bulk(Bag) | 1000 |

Equivalent Circuit

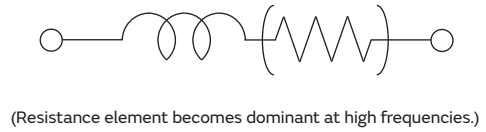

Rated Value (□: packaging code)

| Part Number | Impedance at 100MHz | Rated Current at 85°C | Rated Current at 125°C | DC Resistance | Operating Temp. Range |
|----------------|---------------------|-----------------------|------------------------|---------------|-----------------------|
| BLM31SN500SN1□ | 50Ω±12.5Ω | 12A | 10A | 0.0016Ω | -55°C to 125°C |

Z-f characteristics

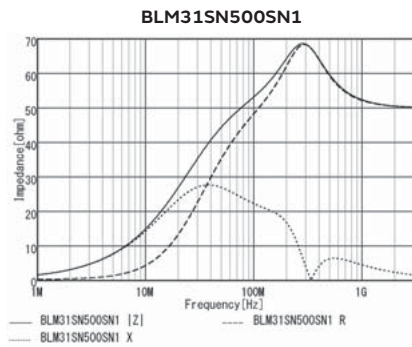

Derating of Rated Current

In operating temperature exceeding +85°C, derating of current is necessary for BLM31SN series. Please apply the derating curve shown in chart according to the operating temperature.

Derating of Rated Current

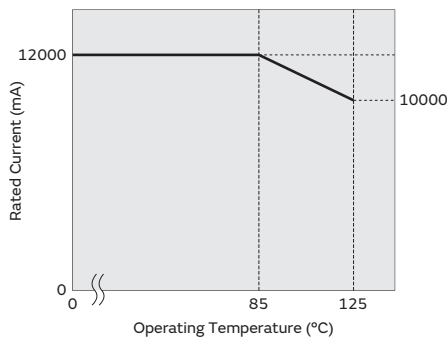

Chip ferrite bead

BLM41PG Series 1806/4516(inch/mm)

Appearance/Dimensions

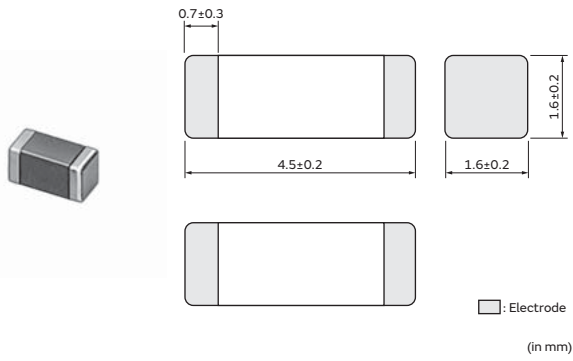

Packaging

| Code | Packaging | Minimum Quantity |
|------|----------------------|------------------|
| K | ø330mm Embossed Tape | 8000 |
| L | ø180mm Embossed Tape | 2500 |
| B | Bulk(Bag) | 1000 |

Equivalent Circuit



(Resistance element becomes dominant at high frequencies.)

Rated Value (□: packaging code)

| Part Number | Impedance at 100MHz | Rated Current at 85°C | Rated Current at 125°C | DC Resistance |
|----------------|---------------------|-----------------------|------------------------|---------------|
| BLM41PG600SN1□ | 60Ω(Typ.) | 6A | 3.7A | 0.009Ω |
| BLM41PG750SN1□ | 75Ω(Typ.) | 3.5A | 2.45A | 0.015Ω |
| BLM41PG181SN1□ | 180Ω±25% | 3.5A | 2.1A | 0.02Ω |
| BLM41PG471SN1□ | 470Ω±25% | 2A | 1.35A | 0.05Ω |
| BLM41PG102SN1□ | 1000Ω±25% | 1.5A | 1A | 0.09Ω |

Operating Temp. Range: -55°C to 125°C

Z-f characteristics

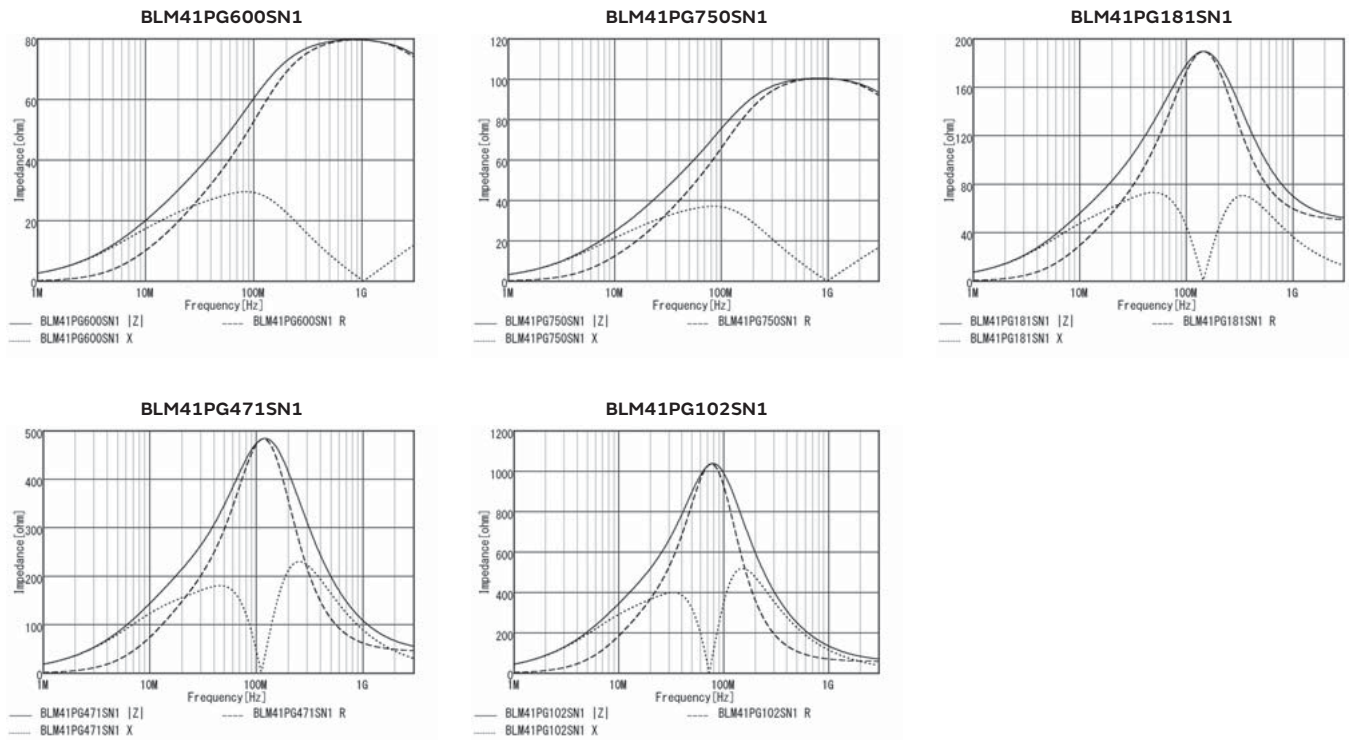

Continued on the following page. ↗

Continued from the preceding page. ↘

Derating of Rated Current

In operating temperature exceeding +85°C, derating of current is necessary for BLM41PG series.
 Please apply the derating curve shown in chart according to the operating temperature.

Derating of Rated Current

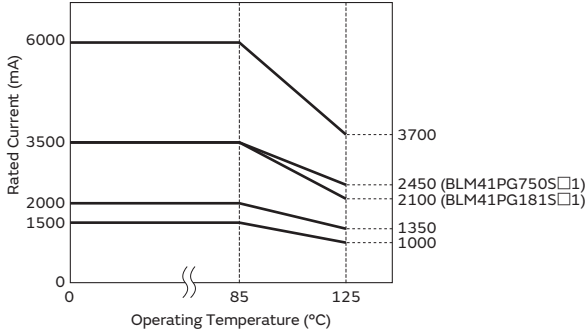

Chip ferrite bead

BLT5BPT_LN1 Series 2020/5050(inch/mm)

Appearance/Dimensions

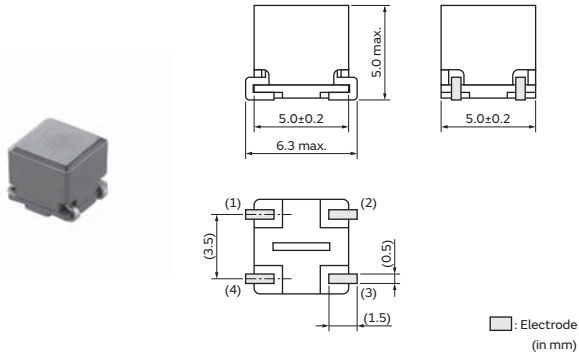

Packaging

| Code | Packaging | Minimum Quantity |
|------|----------------------|------------------|
| L | ø180mm Embossed Tape | 300 |
| B | Bulk(Bag) | 50 |

Equivalent Circuit

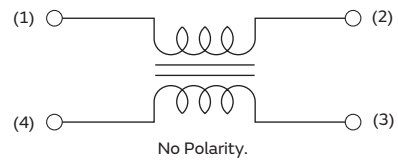

Rated Value (□: packaging code)

| Part Number | Impedance at 100MHz | Rated Current at 85°C | Rated Current at 125°C | Rated Current at 150°C | DC Resistance | Operating Temp. Range |
|----------------|---------------------|-----------------------|------------------------|------------------------|---------------|-----------------------|
| BLT5BPT680LN1□ | 68Ω(Typ.) | 11A | 7A | 4.5A | 10mΩ | -55°C to 150°C |

Z-f characteristics

BLT5BPT680LN1

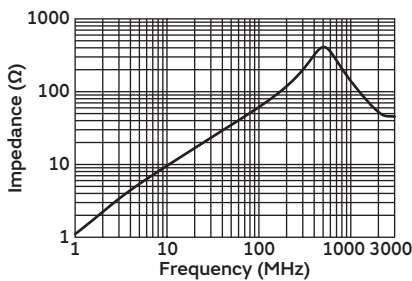

Derating of Rated Current

In operating temperature exceeding +85°C, derating of current is necessary for BLT5BPT_LN1 series. Please apply the derating curve shown in chart according to the operating temperature.

Derating of Rated Current

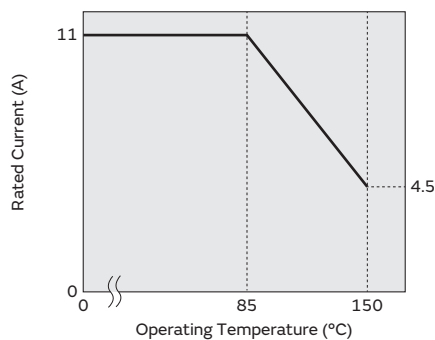

Notification about terminal connection

Connect terminal rightly.

This product consists of two coils. When it is connected to the same power source line and used as a coil, its inherent properties can be obtained. When it is connected to separate power source lines, serious trouble such as open or short circuit or flames due to extreme heat generation occurs.

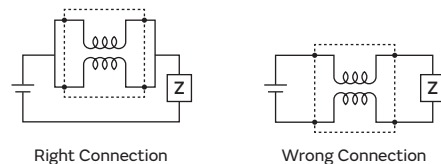

Chip ferrite bead

BLA2AAG Series 0804/2010(inch/mm)

Appearance/Dimensions

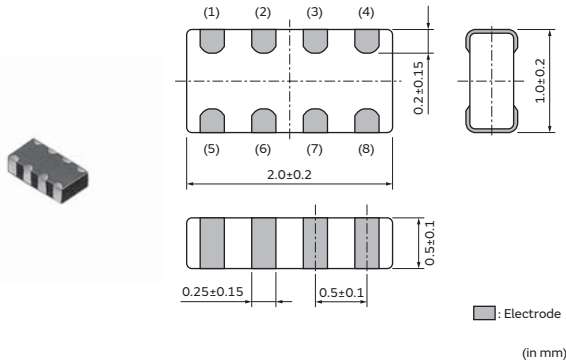

Packaging

| Code | Packaging | Minimum Quantity |
|------|-------------------|------------------|
| D | ø180mm Paper Tape | 10000 |
| J | ø330mm Paper Tape | 50000 |
| B | Bulk(Bag) | 1000 |

Equivalent Circuit

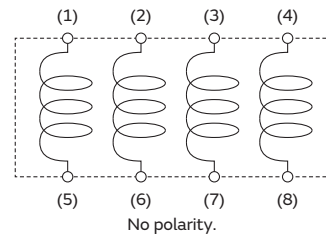

Rated Value (□: packaging code)

| Part Number | Impedance at 100MHz | Rated Current at 85°C | Rated Current at 125°C | DC Resistance |
|----------------|---------------------|-----------------------|------------------------|---------------|
| BLA2AAG121SN4□ | 120Ω±25% | 100mA | 100mA | 0.5Ω |
| BLA2AAG221SN4□ | 220Ω±25% | 50mA | 50mA | 0.7Ω |
| BLA2AAG601SN4□ | 600Ω±25% | 50mA | 50mA | 1.1Ω |
| BLA2AAG102SN4□ | 1000Ω±25% | 50mA | 50mA | 1.3Ω |

Operating Temp. Range: -55°C to 125°C

Z-f characteristics

BLA2AAG121SN4

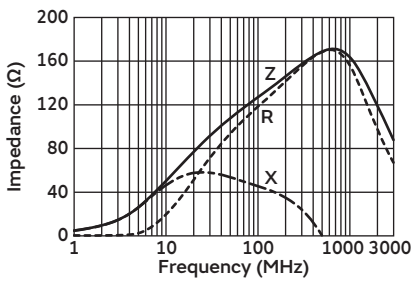

BLA2AAG221SN4

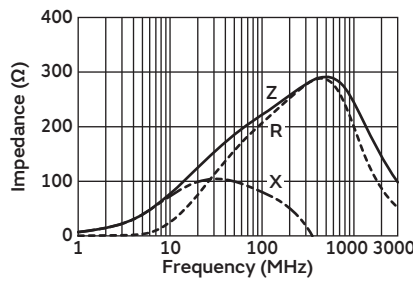

BLA2AAG601SN4

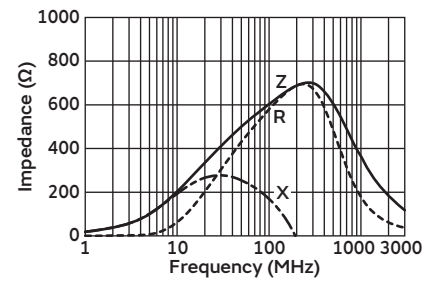

BLA2AAG102SN4

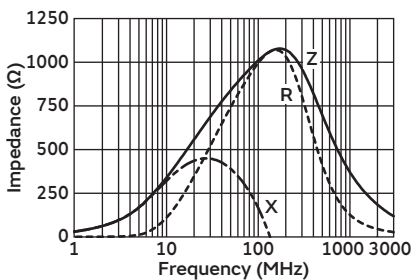

Chip ferrite bead

BLA2ABB/BD Series 0804/2010(inch/mm)

Appearance/Dimensions

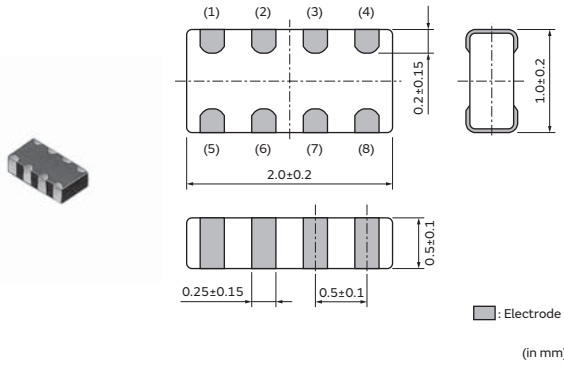

Packaging

| Code | Packaging | Minimum Quantity |
|------|-------------------|------------------|
| D | ø180mm Paper Tape | 10000 |
| J | ø330mm Paper Tape | 50000 |
| B | Bulk(Bag) | 1000 |

Equivalent Circuit

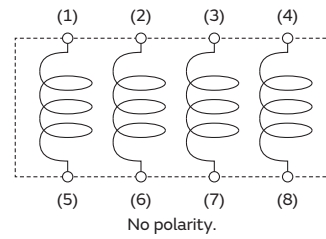

Rated Value (□: packaging code)

| Part Number | Impedance at 100MHz | Rated Current at 85°C | Rated Current at 125°C | DC Resistance |
|----------------|---------------------|-----------------------|------------------------|---------------|
| BLA2ABB100SN4□ | 10Ω±25% | 200mA | 200mA | 0.1Ω |
| BLA2ABB220SN4□ | 22Ω±25% | 200mA | 200mA | 0.2Ω |
| BLA2ABB470SN4□ | 47Ω±25% | 200mA | 200mA | 0.35Ω |
| BLA2ABB121SN4□ | 120Ω±25% | 50mA | 50mA | 0.6Ω |
| BLA2ABB221SN4□ | 220Ω±25% | 50mA | 50mA | 0.9Ω |
| BLA2ABD750SN4□ | 75Ω±25% | 200mA | 200mA | 0.2Ω |
| BLA2ABD121SN4□ | 120Ω±25% | 200mA | 200mA | 0.35Ω |
| BLA2ABD221SN4□ | 220Ω±25% | 100mA | 100mA | 0.4Ω |
| BLA2ABD471SN4□ | 470Ω±25% | 100mA | 100mA | 0.65Ω |
| BLA2ABD601SN4□ | 600Ω±25% | 100mA | 100mA | 0.8Ω |
| BLA2ABD102SN4□ | 1000Ω±25% | 50mA | 50mA | 1Ω |

Operating Temp. Range: -55°C to 125°C

Z-f characteristics

BLA2ABB100SN4

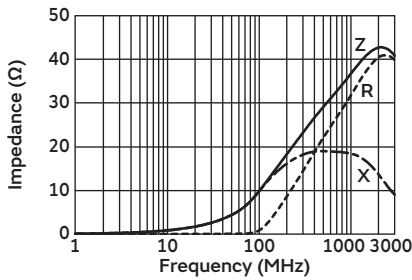

BLA2ABB220SN4

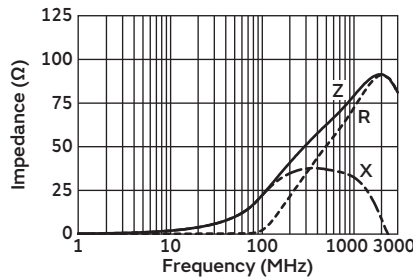

BLA2ABB470SN4

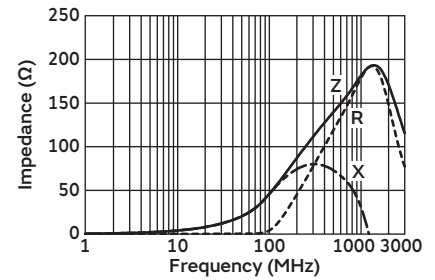

Continued on the following page. ↗

Chip Ferrite Bead

Application Specified Noise Filter

Chip EMIFIL®

Common Mode Choke Coil
 Common Mode Noise Filter

Block Type EMIFIL®

EMC Absorber

Continued from the preceding page. ↘

Z-f characteristics

BLA2ABB121SN4

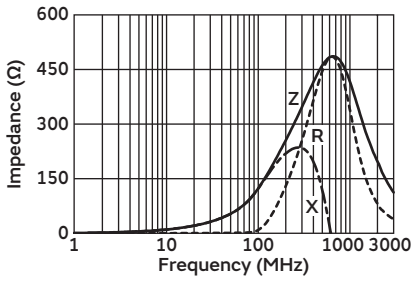

BLA2ABB221SN4

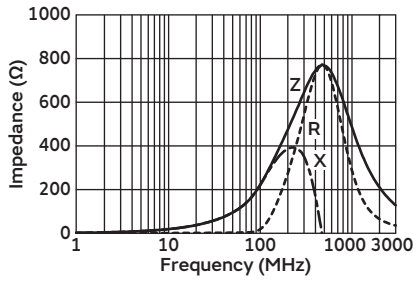

BLA2ABD750SN4

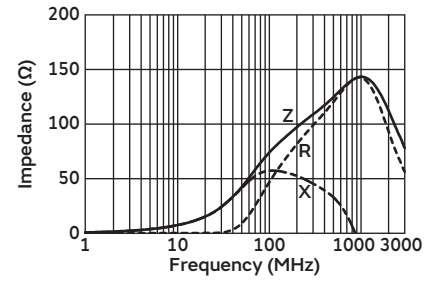

BLA2ABD121SN4

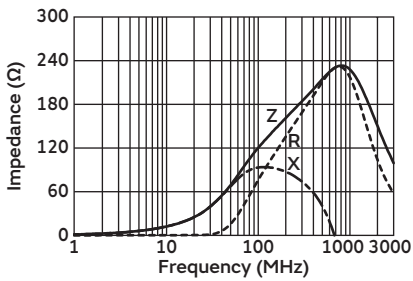

BLA2ABD221SN4

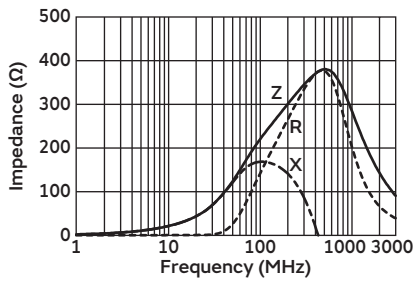

BLA2ABD471SN4

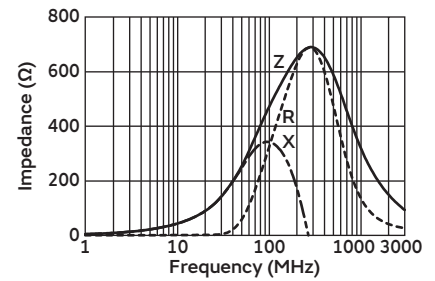

BLA2ABD601SN4

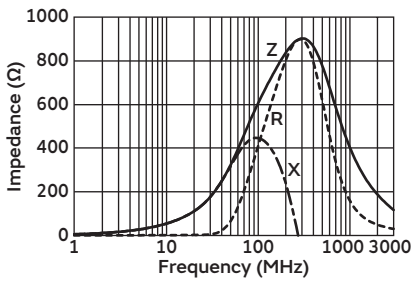

BLA2ABD102SN4

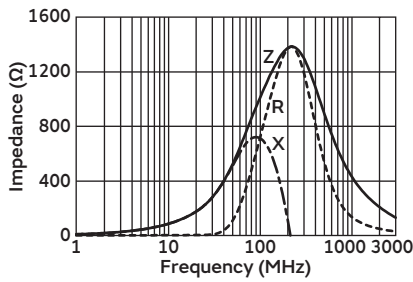

Chip Ferrite Bead

Application Specified Noise Filter

Chip EMIFIL®

Common Mode Choke Coil
 Common Mode Noise Filter

Block Type EMIFIL®

EMC Absorber

Chip ferrite bead

BLA31AG Series 1206/3216(inch/mm)

Appearance/Dimensions

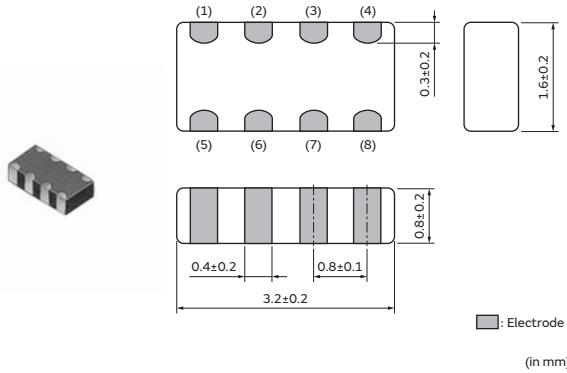

Packaging

| Code | Packaging | Minimum Quantity |
|------|-------------------|------------------|
| D | ø180mm Paper Tape | 4000 |
| J | ø330mm Paper Tape | 10000 |
| B | Bulk(Bag) | 1000 |

Equivalent Circuit

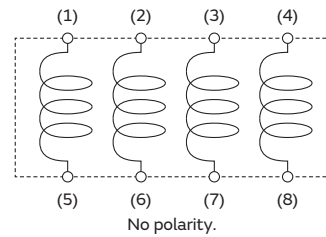

Rated Value (□: packaging code)

| Part Number | Impedance at 100MHz | Rated Current at 85°C | Rated Current at 125°C | DC Resistance |
|----------------|---------------------|-----------------------|------------------------|---------------|
| BLA31AG300SN4□ | 30Ω±25% | 200mA | 200mA | 0.1Ω |
| BLA31AG600SN4□ | 60Ω±25% | 200mA | 200mA | 0.15Ω |
| BLA31AG121SN4□ | 120Ω±25% | 150mA | 150mA | 0.2Ω |
| BLA31AG221SN4□ | 220Ω±25% | 150mA | 150mA | 0.25Ω |
| BLA31AG601SN4□ | 600Ω±25% | 100mA | 100mA | 0.35Ω |
| BLA31AG102SN4□ | 1000Ω±25% | 50mA | 50mA | 0.45Ω |

Operating Temp. Range: -55°C to 125°C

Z-f characteristics

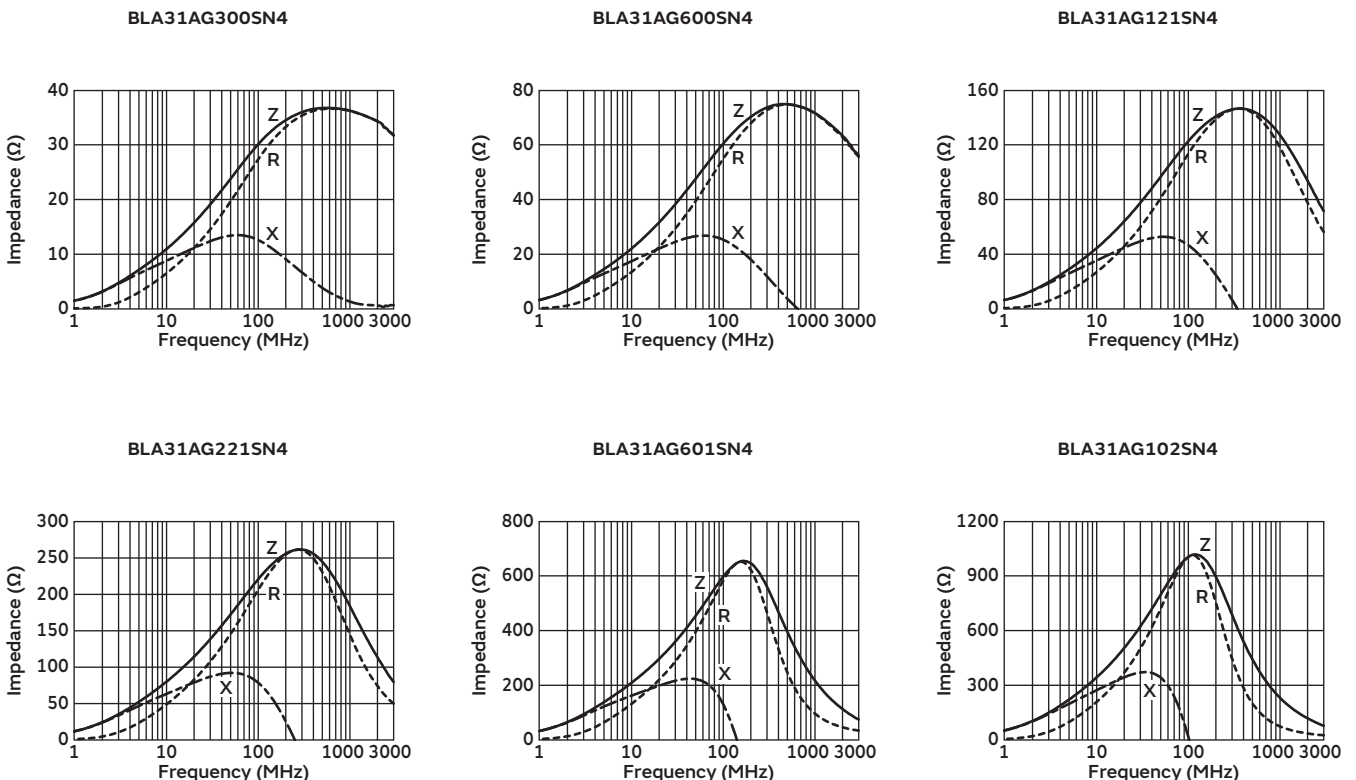

Chip Ferrite Bead
Application Specified Noise Filter
Chip EMIFIL®
Common Mode Choke Coil
Common Mode Noise Filter
Block Type EMIFIL®
EMC Absorber

Chip ferrite bead

BLA31BD Series 1206/3216(inch/mm)

Appearance/Dimensions

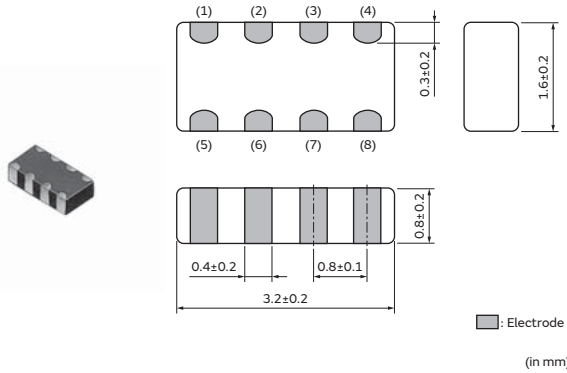

Packaging

| Code | Packaging | Minimum Quantity |
|------|-------------------|------------------|
| D | ø180mm Paper Tape | 4000 |
| J | ø330mm Paper Tape | 10000 |
| B | Bulk(Bag) | 1000 |

Equivalent Circuit

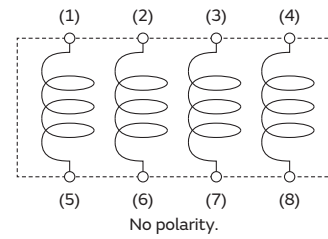

Rated Value (□: packaging code)

| Part Number | Impedance at 100MHz | Rated Current at 85°C | Rated Current at 125°C | DC Resistance |
|----------------|---------------------|-----------------------|------------------------|---------------|
| BLA31BD121SN4□ | 120Ω±25% | 150mA | 150mA | 0.3Ω |
| BLA31BD221SN4□ | 220Ω±25% | 150mA | 150mA | 0.35Ω |
| BLA31BD471SN4□ | 470Ω±25% | 100mA | 100mA | 0.4Ω |
| BLA31BD601SN4□ | 600Ω±25% | 100mA | 100mA | 0.45Ω |
| BLA31BD102SN4□ | 1000Ω±25% | 50mA | 50mA | 0.55Ω |

Operating Temp. Range: -55°C to 125°C

Z-f characteristics

BLA31BD121SN4

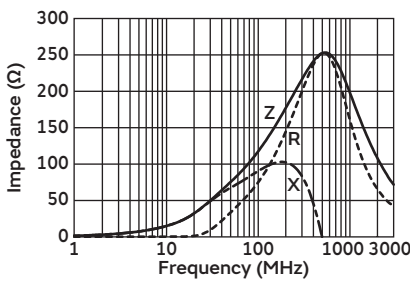

BLA31BD221SN4

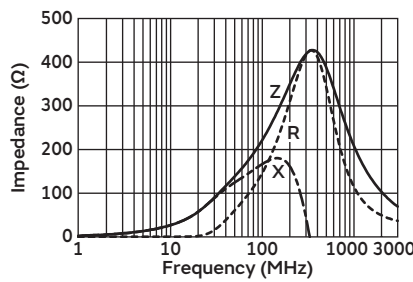

BLA31BD471SN4

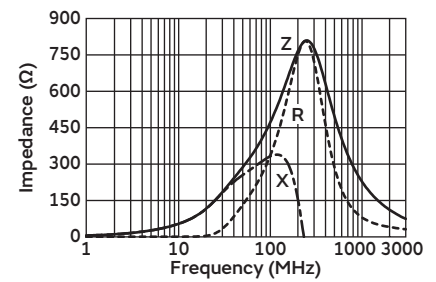

BLA31BD601SN4

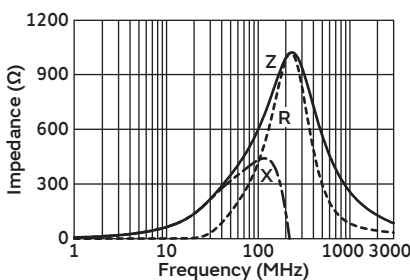

BLA31BD102SN4

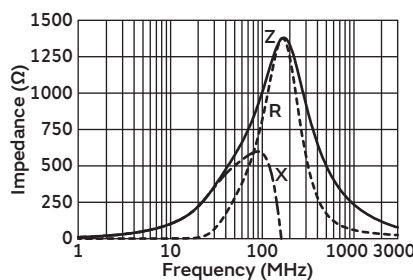

Chip ferrite bead

BLM03HB/HD/HG Series 0201/0603(inch/mm)

Appearance/Dimensions

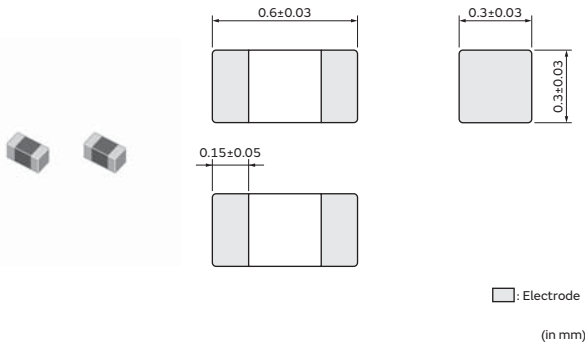

Packaging

| Code | Packaging | Minimum Quantity |
|------|-------------------|------------------|
| D | ø180mm Paper Tape | 15000 |
| J | ø330mm Paper Tape | 50000 |
| B | Bulk(Bag) | 1000 |

Equivalent Circuit



(Resistance element becomes dominant at high frequencies.)

Rated Value (□: packaging code)

| Part Number | Impedance at 100MHz | Impedance at 1GHz | Rated Current at 85°C | Rated Current at 125°C | DC Resistance |
|----------------|---------------------|-------------------|-----------------------|------------------------|---------------|
| BLM03HB191SN1□ | 190Ω±25% | 1150Ω±40% | 150mA | 150mA | 2Ω |
| BLM03HB401SN1□ | 400Ω±25% | 1850Ω±40% | 125mA | 125mA | 2.8Ω |
| BLM03HD102FN1□ | 1000Ω±25% | 2300Ω±40% | 135mA | 135mA | 2.4Ω |
| BLM03HD152FN1□ | 1500Ω±25% | 2700Ω±40% | 120mA | 120mA | 3.1Ω |
| BLM03HD182FN1□ | 1800Ω±25% | 3000Ω±40% | 100mA | 100mA | 3.8Ω |
| BLM03HD331SN1□ | 330Ω±25% | 750Ω±40% | 200mA | 200mA | 1Ω |
| BLM03HD471SN1□ | 470Ω±25% | 1000Ω±40% | 175mA | 175mA | 1.3Ω |
| BLM03HD601SN1□ | 600Ω±25% | 1500Ω±40% | 150mA | 150mA | 1.7Ω |
| BLM03HD102SN1□ | 1000Ω±25% | 2300Ω±40% | 120mA | 120mA | 2.9Ω |
| BLM03HG601SN1□ | 600Ω±25% | 1000Ω±40% | 150mA | 150mA | 1.6Ω |
| BLM03HG102SN1□ | 1000Ω±25% | 1800Ω±40% | 125mA | 125mA | 2.6Ω |
| BLM03HG122SN1□ | 1200Ω±25% | 2000Ω±40% | 100mA | 100mA | 3.5Ω |

Operating Temp. Range: -55°C to 125°C

Z-f characteristics

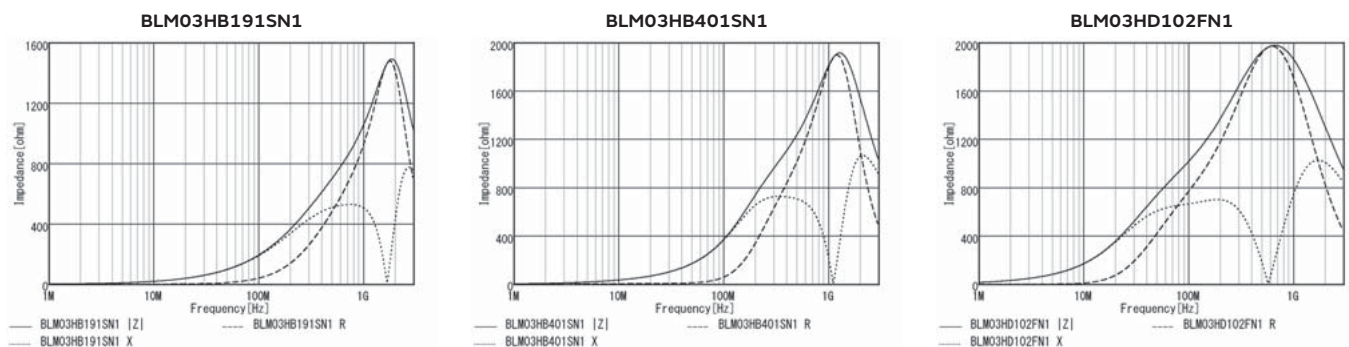

Continued on the following page. ↗

Chip Ferrite Bead

Application Specified Noise Filter

Chip EMIFIL®

Common Mode Choke Coil
 Common Mode Noise Filter

Block Type EMIFIL®

EMC Absorber

Continued from the preceding page. ↘

Z-f characteristics

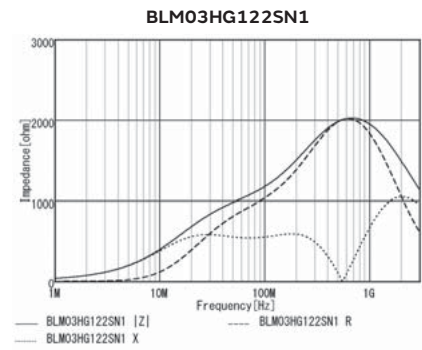
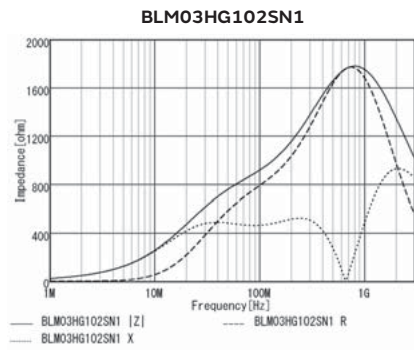
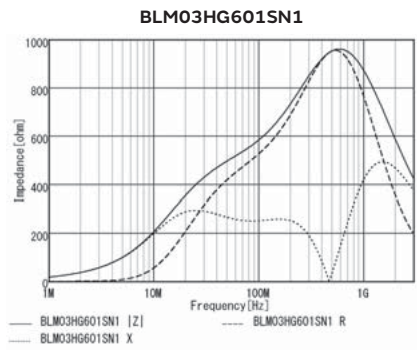
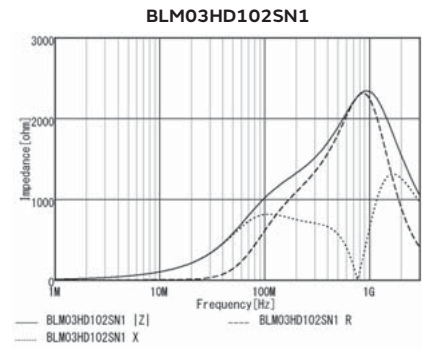
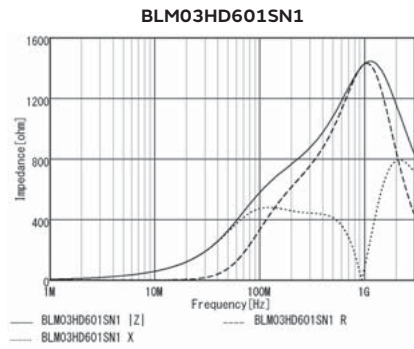
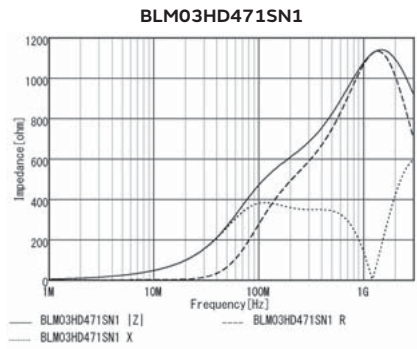
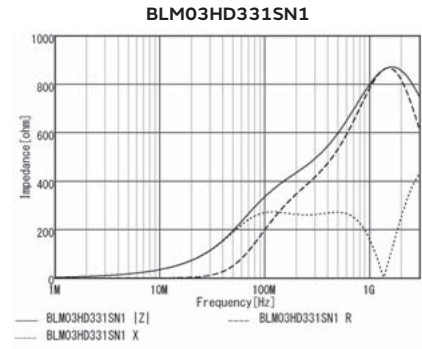
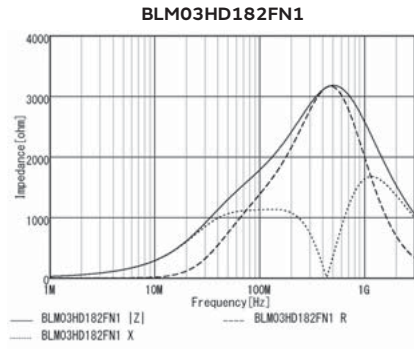
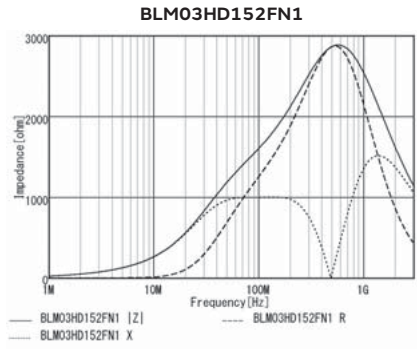

Chip ferrite bead

BLM03EB Series 0201/0603(inch/mm)

Appearance/Dimensions

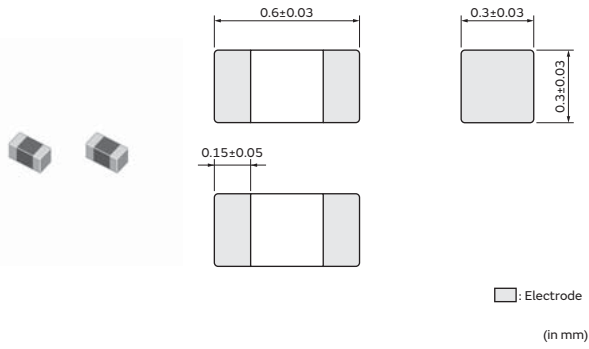

Packaging

| Code | Packaging | Minimum Quantity |
|------|-------------------|------------------|
| D | ø180mm Paper Tape | 15000 |
| J | ø330mm Paper Tape | 50000 |
| B | Bulk(Bag) | 1000 |

Equivalent Circuit

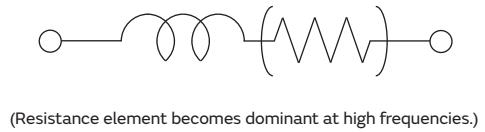

Rated Value (□: packaging code)

| Part Number | Impedance at 100MHz | Impedance at 1GHz | Rated Current at 85°C | Rated Current at 125°C | DC Resistance |
|----------------|---------------------|-------------------|-----------------------|------------------------|---------------|
| BLM03EB250SN1□ | 25Ω±25% | 105Ω±40% | 600mA | 450mA | 0.26Ω |
| BLM03EB500SN1□ | 50Ω±25% | 255Ω±40% | 400mA | 300mA | 0.58Ω |

Operating Temp. Range: -55°C to 125°C

Z-f characteristics

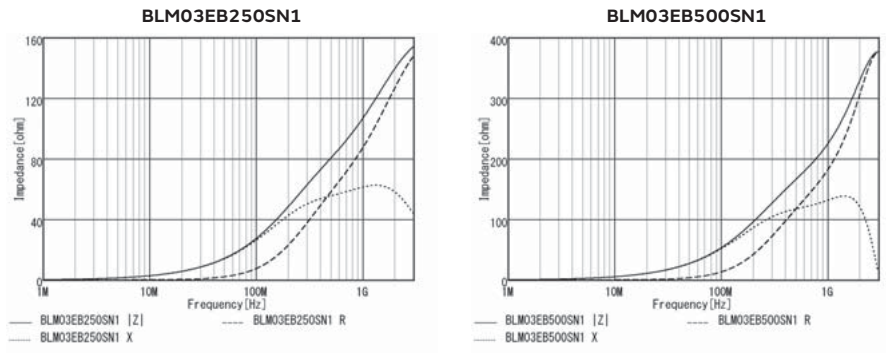

Derating of Rated Current

In operating temperature exceeding +85°C, derating of current is necessary for BLM03E series.
 Please apply the derating curve shown in chart according to the operating temperature.

Derating of Rated Current

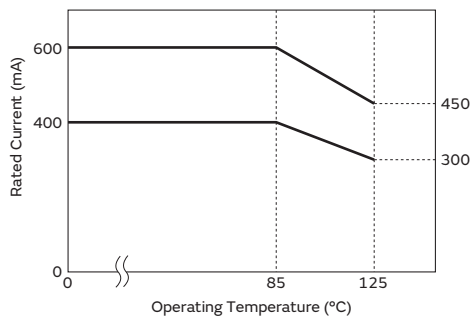

Chip ferrite bead

BLM15HB/HD/HG Series 0402/1005(inch/mm)

Appearance/Dimensions

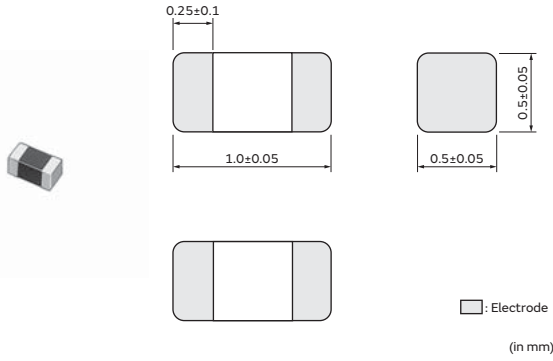

Packaging

| Code | Packaging | Minimum Quantity |
|------|-------------------|------------------|
| D | ø180mm Paper Tape | 10000 |
| J | ø330mm Paper Tape | 50000 |
| B | Bulk(Bag) | 1000 |

Equivalent Circuit



(Resistance element becomes dominant at high frequencies.)

Rated Value (□: packaging code)

| Part Number | Impedance at 100MHz | Impedance at 1GHz | Rated Current at 85°C | Rated Current at 125°C | DC Resistance |
|----------------|---------------------|-------------------|-----------------------|------------------------|---------------|
| BLM15HB121SN1□ | 120Ω±25% | 500Ω±40% | 300mA | 300mA | 0.7Ω |
| BLM15HB221SN1□ | 220Ω±25% | 900Ω±40% | 250mA | 250mA | 1Ω |
| BLM15HD601SN1□ | 600Ω±25% | 1400Ω±40% | 300mA | 300mA | 0.85Ω |
| BLM15HD102SN1□ | 1000Ω±25% | 2000Ω±40% | 250mA | 250mA | 1.25Ω |
| BLM15HD182SN1□ | 1800Ω±25% | 2700Ω±40% | 200mA | 200mA | 2.2Ω |
| BLM15HG601SN1□ | 600Ω±25% | 1000Ω±40% | 300mA | 300mA | 0.7Ω |
| BLM15HG102SN1□ | 1000Ω±25% | 1400Ω±40% | 250mA | 250mA | 1.1Ω |

Operating Temp. Range: -55°C to 125°C

Z-f characteristics

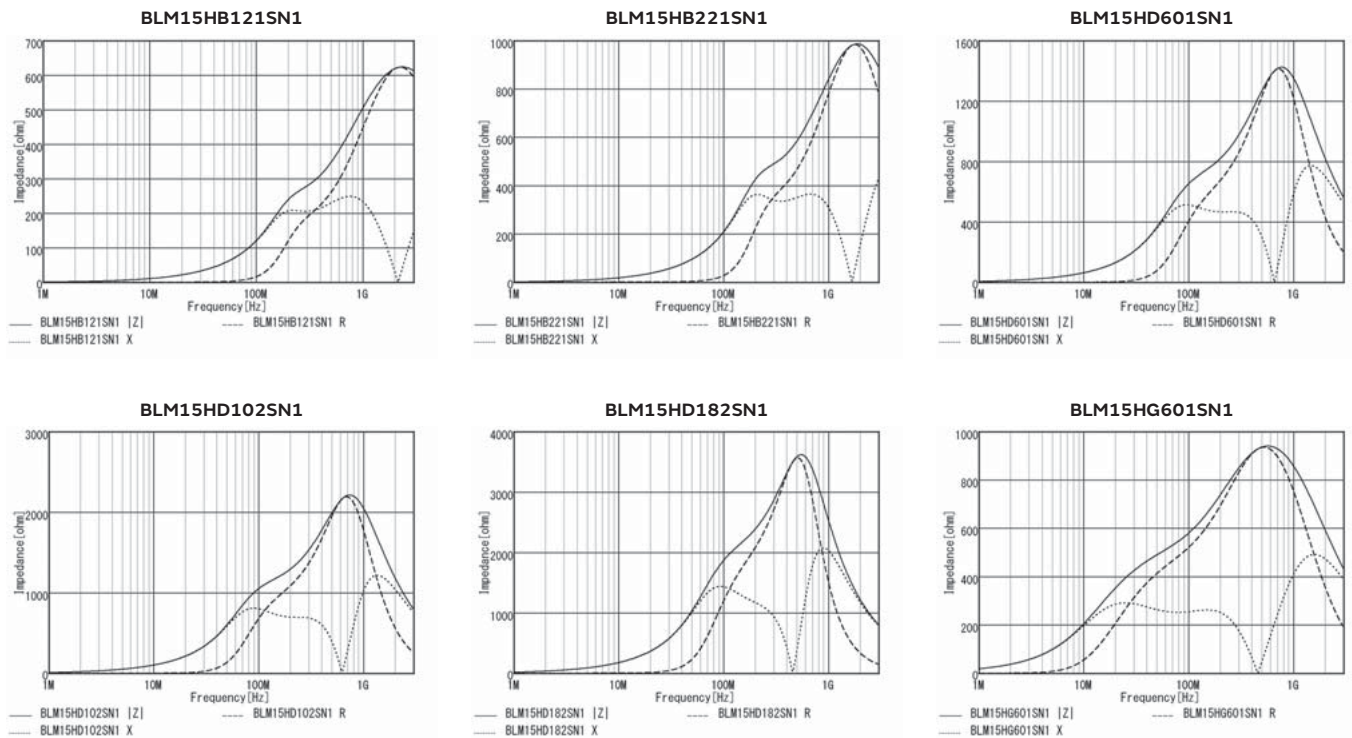

Continued on the following page. ↗

Continued from the preceding page. ↘

Z-f characteristics

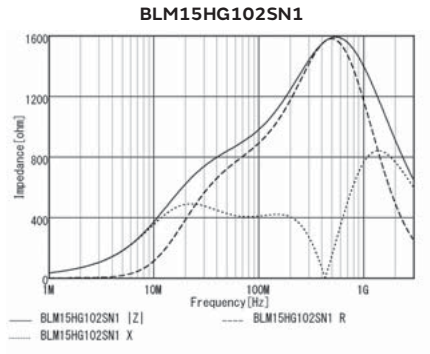

Chip Ferrite Bead

Application Specified Noise Filter

Chip EMIFIL®

Common Mode Choke Coil
 Common Mode Noise Filter

Block Type EMIFIL®

EMC Absorber

Chip ferrite bead

BLM15EG Series 0402/1005(inch/mm)

Appearance/Dimensions

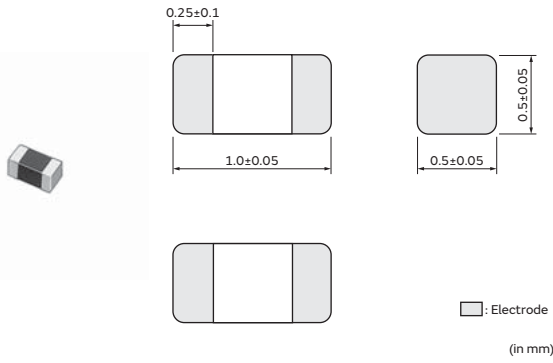

Packaging

| Code | Packaging | Minimum Quantity |
|------|-------------------|------------------|
| D | ø180mm Paper Tape | 10000 |
| J | ø330mm Paper Tape | 50000 |
| B | Bulk(Bag) | 1000 |

Equivalent Circuit



(Resistance element becomes dominant at high frequencies.)

Rated Value (□: packaging code)

| Part Number | Impedance at 100MHz | Impedance at 1GHz | Rated Current at 85°C | Rated Current at 125°C | DC Resistance |
|----------------|---------------------|-------------------|-----------------------|------------------------|---------------|
| BLM15EG121SN1□ | 120Ω±25% | 145Ω(Typ.) | 1.5A | 900mA | 0.095Ω |
| BLM15EG221SN1□ | 220Ω±25% | 270Ω(Typ.) | 700mA | 500mA | 0.28Ω |

Operating Temp. Range: -55°C to 125°C

Z-f characteristics

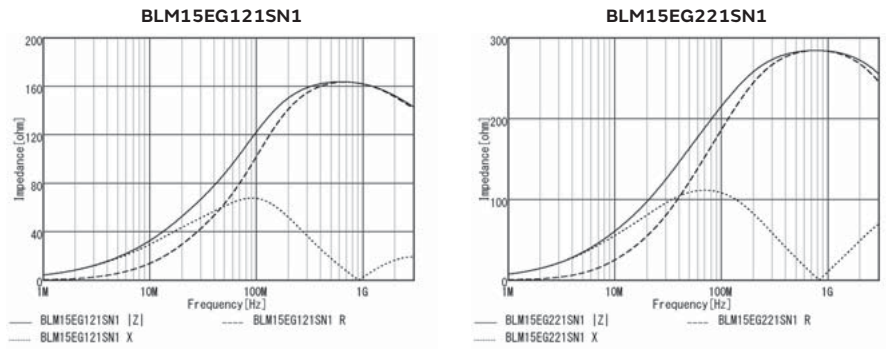

Derating of Rated Current

In operating temperature exceeding +85°C, derating of current is necessary for BLM15E series.
 Please apply the derating curve shown in chart according to the operating temperature.

Derating of Rated Current

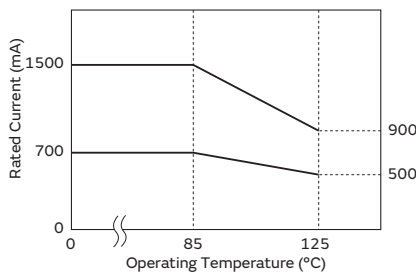

Chip ferrite bead

BLM15EX Series 0402/1005(inch/mm)

Appearance/Dimensions

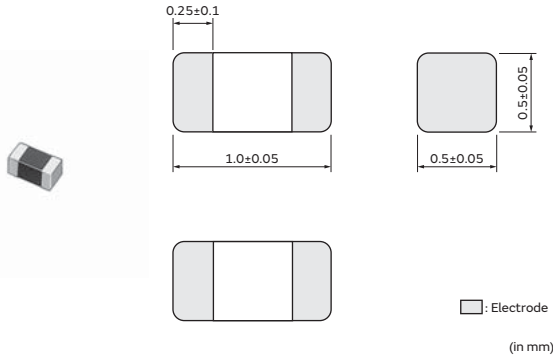

Packaging

| Code | Packaging | Minimum Quantity |
|------|-------------------|------------------|
| D | ø180mm Paper Tape | 10000 |
| J | ø330mm Paper Tape | 50000 |
| B | Bulk(Bag) | 1000 |

Equivalent Circuit



(Resistance element becomes dominant at high frequencies.)

Rated Value (□: packaging code)

| Part Number | Impedance at 100MHz | Impedance at 1GHz | Rated Current at 85°C | Rated Current at 125°C | DC Resistance |
|----------------|---------------------|-------------------|-----------------------|------------------------|---------------|
| BLM15EX121SN1□ | 120Ω±25% | 170Ω±40% | 1.8A | 1.2A | 0.075Ω |
| BLM15EX221SN1□ | 220Ω±25% | 300Ω±40% | 1.3A | 850mA | 0.14Ω |
| BLM15EX331SN1□ | 330Ω±25% | 450Ω±40% | 1.1A | 700mA | 0.205Ω |
| BLM15EX471SN1□ | 470Ω±25% | 630Ω±40% | 950mA | 600mA | 0.28Ω |

Operating Temp. Range: -55°C to 125°C

Z-f characteristics

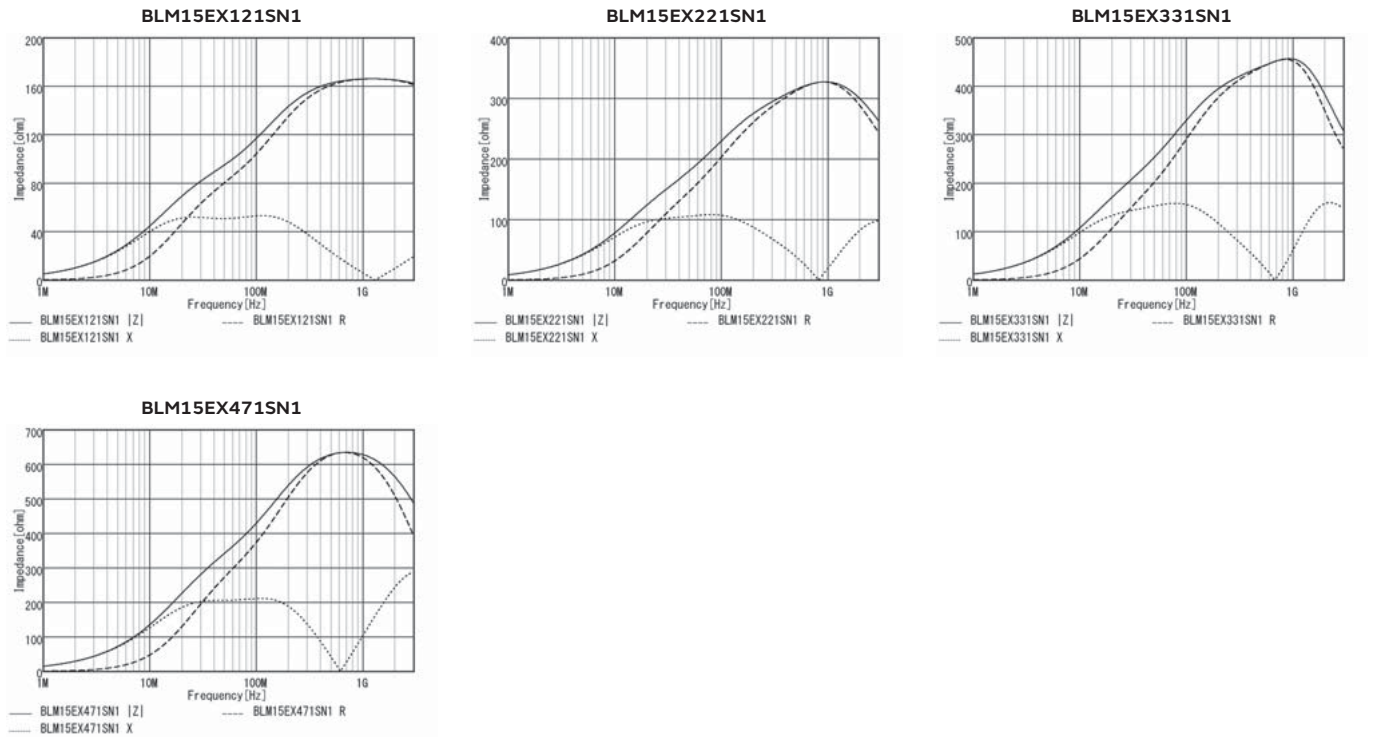

Continued on the following page. ↗

Continued from the preceding page. ↘

Derating of Rated Current

In operating temperature exceeding +85°C, derating of current is necessary for BLM15EX series.
Please apply the derating curve shown in chart according to the operating temperature.

Derating of Rated Current

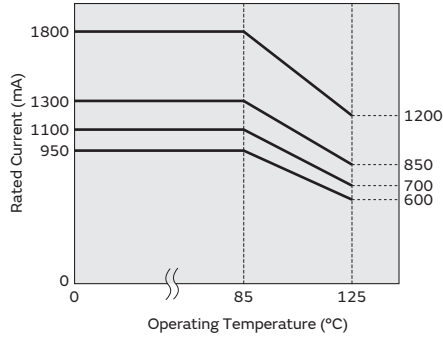

Chip ferrite bead

BLM15GA/GG Series 0402/1005(inch/mm)

Appearance/Dimensions

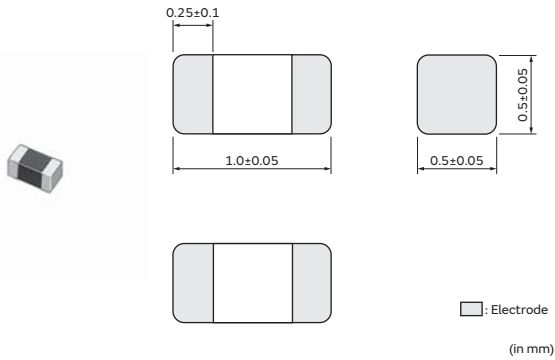

Packaging

| Code | Packaging | Minimum Quantity |
|------|-------------------|------------------|
| D | ø180mm Paper Tape | 10000 |
| J | ø330mm Paper Tape | 50000 |
| B | Bulk(Bag) | 1000 |

Equivalent Circuit



(Resistance element becomes dominant at high frequencies.)

Rated Value (□: packaging code)

| Part Number | Impedance at 100MHz | Impedance at 1GHz | Rated Current at 85°C | Rated Current at 125°C | DC Resistance |
|----------------|---------------------|-------------------|-----------------------|------------------------|---------------|
| BLM15GA750SN1□ | 75Ω±25% | 1000Ω±40% | 200mA | 200mA | 1.3Ω |
| BLM15GG221SN1□ | 220Ω±25% | 600Ω±40% | 300mA | 300mA | 0.7Ω |
| BLM15GG471SN1□ | 470Ω±25% | 1200Ω±40% | 200mA | 200mA | 1.3Ω |

Operating Temp. Range: -55°C to 125°C

Z-f characteristics

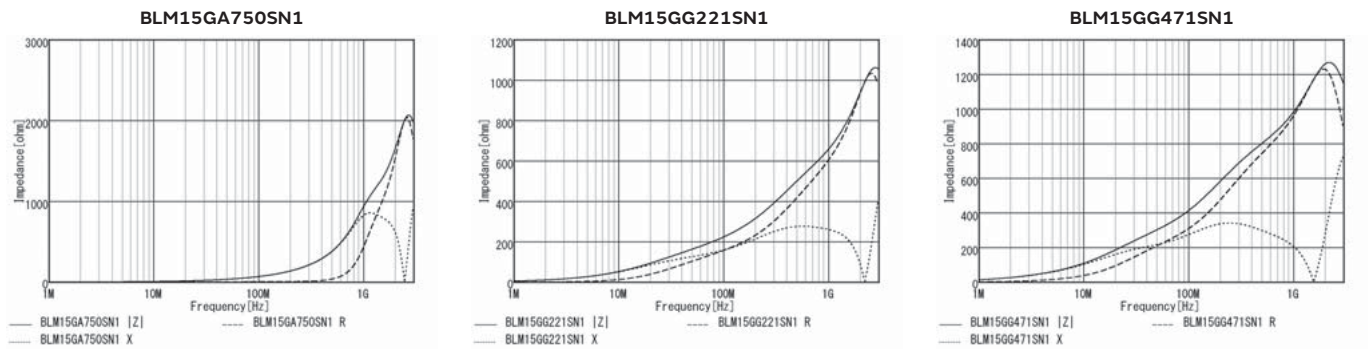

Chip ferrite bead

BLM18HB/HD/HE/HG/HK Series 0603/1608(inch/mm)

Appearance/Dimensions

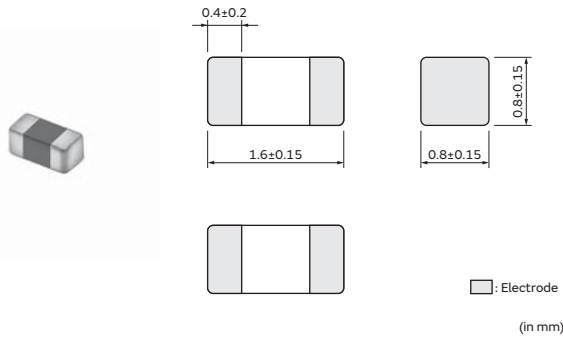

Packaging

| Code | Packaging | Minimum Quantity |
|------|-------------------|------------------|
| D | ø180mm Paper Tape | 4000 |
| J | ø330mm Paper Tape | 10000 |
| B | Bulk(Bag) | 1000 |

Equivalent Circuit



(Resistance element becomes dominant at high frequencies.)

Rated Value (□: packaging code)

| Part Number | Impedance at 100MHz | Impedance at 1GHz | Rated Current at 85°C | Rated Current at 125°C | DC Resistance |
|----------------|---------------------|-------------------|-----------------------|------------------------|---------------|
| BLM18HB121SN1□ | 120Ω±25% | 500Ω±40% | 200mA | 200mA | 0.5Ω |
| BLM18HB221SN1□ | 220Ω±25% | 1100Ω±40% | 100mA | 100mA | 0.8Ω |
| BLM18HB331SN1□ | 330Ω±25% | 1600Ω±40% | 50mA | 50mA | 1.2Ω |
| BLM18HD471SN1□ | 470Ω±25% | 1000Ω(Typ.) | 100mA | 100mA | 1.2Ω |
| BLM18HD601SN1□ | 600Ω±25% | 1200Ω(Typ.) | 100mA | 100mA | 1.5Ω |
| BLM18HD102SN1□ | 1000Ω±25% | 1700Ω(Typ.) | 50mA | 50mA | 1.8Ω |
| BLM18HE601SN1□ | 600Ω±25% | 600Ω(Typ.) | 800mA | 600mA | 0.25Ω |
| BLM18HE102SN1□ | 1000Ω±25% | 1000Ω(Typ.) | 600mA | 500mA | 0.35Ω |
| BLM18HE152SN1□ | 1500Ω±25% | 1500Ω(Typ.) | 500mA | 400mA | 0.5Ω |
| BLM18HG471SN1□ | 470Ω±25% | 600Ω(Typ.) | 200mA | 200mA | 0.85Ω |
| BLM18HG601SN1□ | 600Ω±25% | 700Ω(Typ.) | 200mA | 200mA | 1Ω |
| BLM18HG102SN1□ | 1000Ω±25% | 1000Ω(Typ.) | 100mA | 100mA | 1.6Ω |
| BLM18HK331SN1□ | 330Ω±25% | 400Ω±40% | 200mA | 200mA | 0.5Ω |
| BLM18HK471SN1□ | 470Ω±25% | 600Ω±40% | 200mA | 200mA | 0.7Ω |
| BLM18HK601SN1□ | 600Ω±25% | 700Ω±40% | 100mA | 100mA | 0.9Ω |
| BLM18HK102SN1□ | 1000Ω±25% | 1200Ω±40% | 50mA | 50mA | 1.5Ω |

Operating Temp. Range: -55°C to 125°C

Z-f characteristics

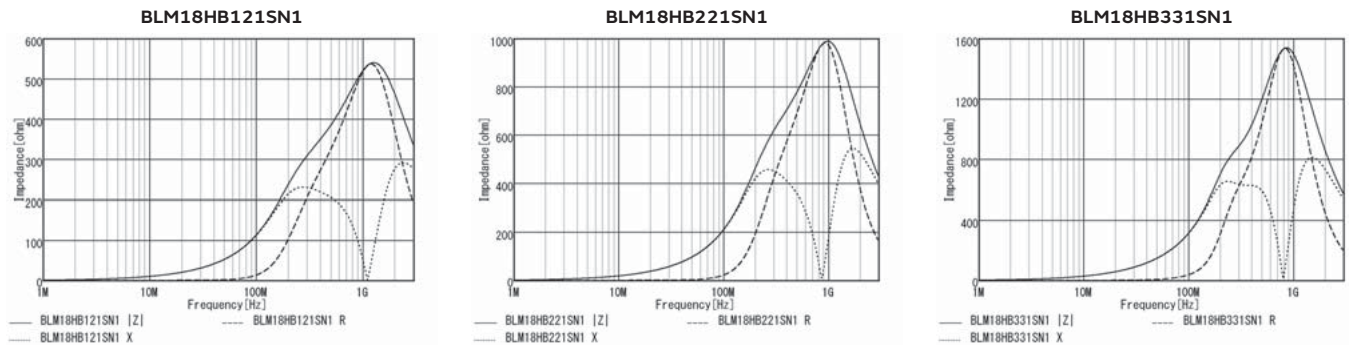

Continued on the following page. ↗

Continued from the preceding page. ↘

Z-f characteristics

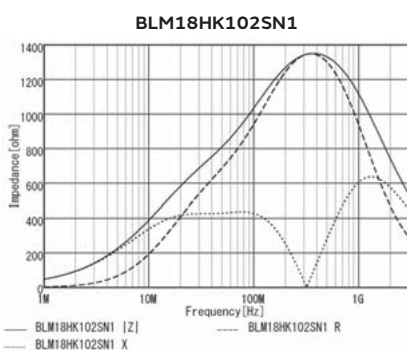
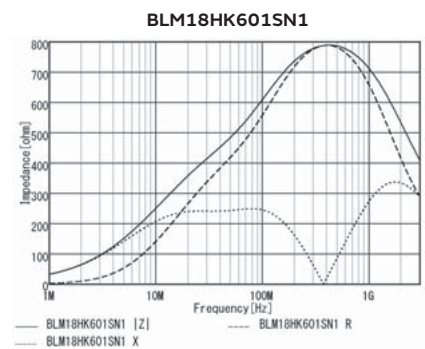
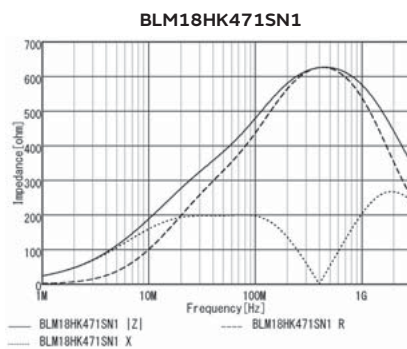
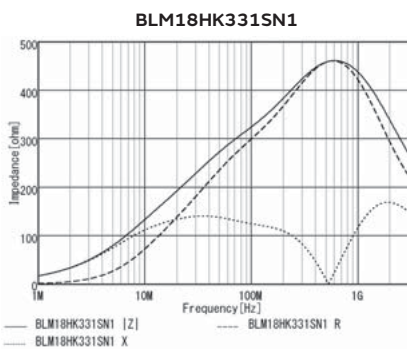
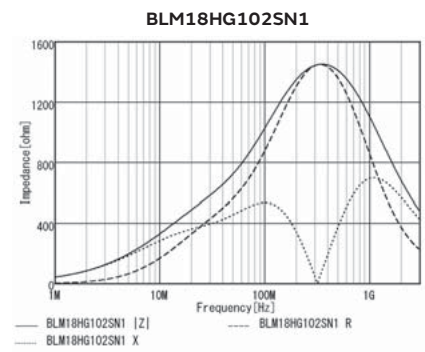
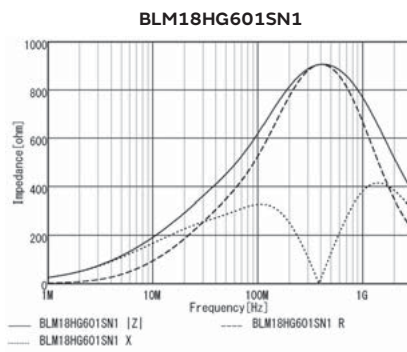
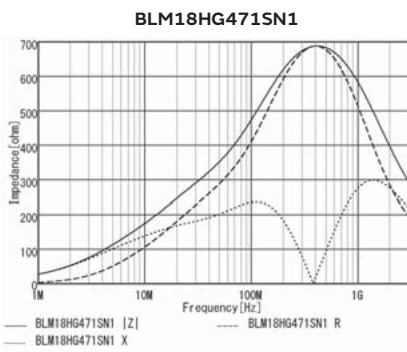
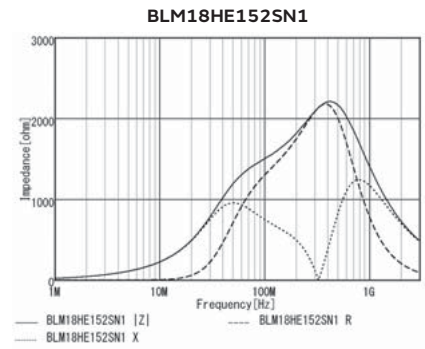
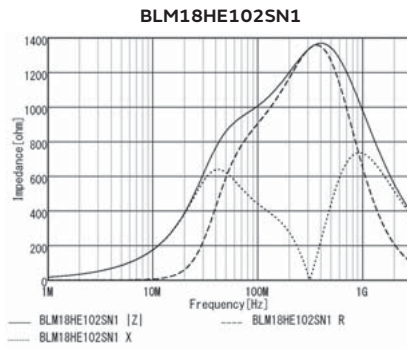
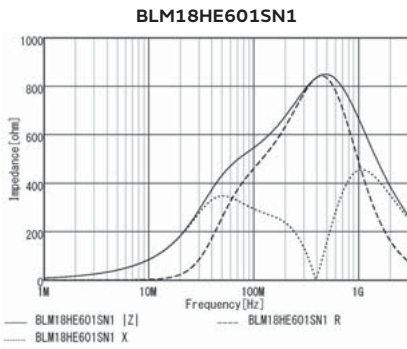
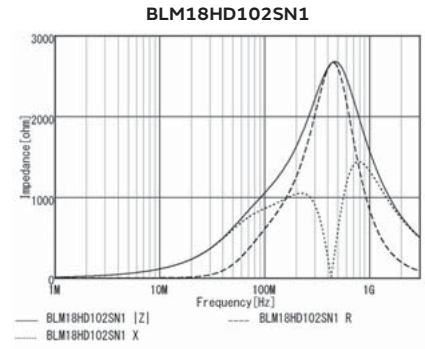
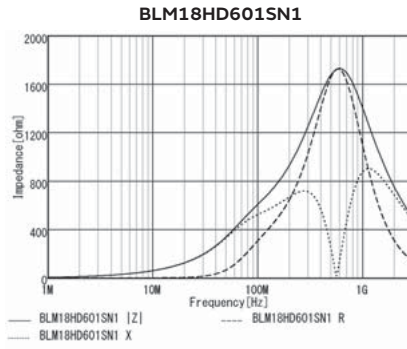
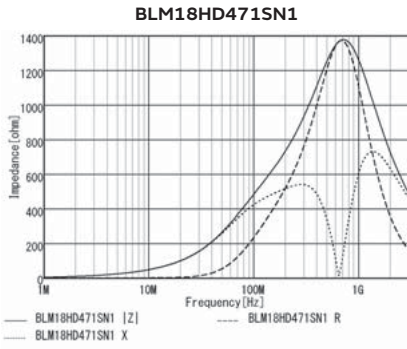

Chip Ferrite Bead

Application Specified Noise Filter

Chip EMIFIL®

Common Mode Choke Coil
 Common Mode Noise Filter

Block Type EMIFIL®

EMC Absorber

Continued from the preceding page. ↘

Derating of Rated Current

In operating temperature exceeding +85°C, derating of current is necessary for BLM18HE series.
Please apply the derating curve shown in chart according to the operating temperature.

Derating of Rated Current

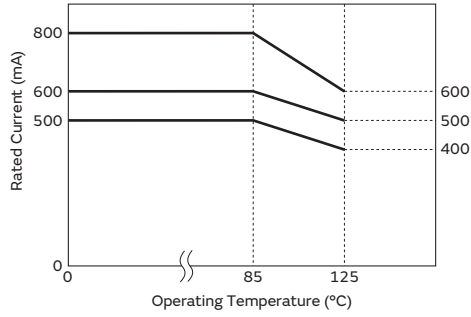

Chip Ferrite Bead (BLM18H Series) EMI Suppression Effect

Noise Suppression of BLM18H in UHF Range

Testing Circuit

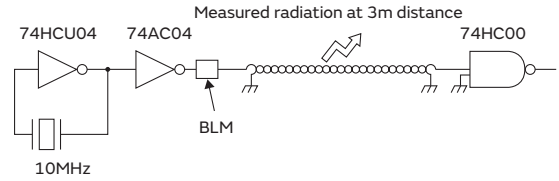

| Type of Filter | EMI Suppression Effect / Description |
|---|--|
| Initial (No filter) | |
| Conventional Type BLM18AG102SN1 (1000Ω at 100MHz) | <p>Current BLM18AG are effective in suppressing noise in the range between 300MHz and 700MHz.</p> |
| for GHz Noise Suppression BLM18HG102SN1 (1000Ω at 100MHz) | <p>In addition to the effectiveness of current BLM, BLM18HG suppresses noise in the range beyond 700MHz.</p> |

Comparison between BLM18HG102SN1 and BLM18AG102SN1 (Current Item)

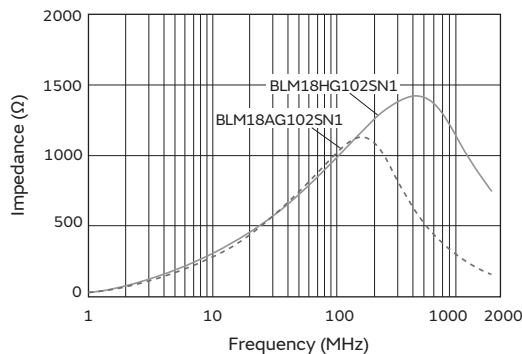

Chip ferrite bead

BLM18EG Series 0603/1608(inch/mm)

Appearance/Dimensions

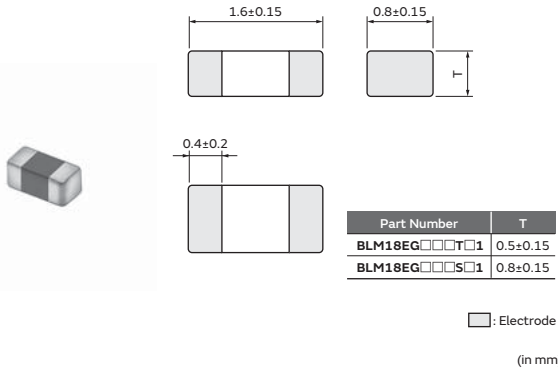

Packaging

| Code | Packaging | Minimum Quantity |
|------|-------------------|------------------|
| D | ø180mm Paper Tape | 4000 |
| J | ø330mm Paper Tape | 10000 |
| B | Bulk(Bag) | 1000 |

Equivalent Circuit



(Resistance element becomes dominant at high frequencies.)

Rated Value (□: packaging code)

| Part Number | Impedance at 100MHz | Impedance at 1GHz | Rated Current at 85°C | Rated Current at 125°C | DC Resistance |
|----------------|---------------------|-------------------|-----------------------|------------------------|---------------|
| BLM18EG121SN1□ | 120Ω±25% | 145Ω(Typ.) | 2A | 1A | 0.04Ω |
| BLM18EG221SN1□ | 220Ω±25% | 260Ω(Typ.) | 2A | 1A | 0.05Ω |
| BLM18EG471SN1□ | 470Ω±25% | 550Ω(Typ.) | 500mA | 500mA | 0.21Ω |
| BLM18EG601SN1□ | 600Ω±25% | 700Ω(Typ.) | 500mA | 500mA | 0.35Ω |
| BLM18EG101TN1□ | 100Ω±25% | 140Ω(Typ.) | 2A | 1A | 0.045Ω |
| BLM18EG221TN1□ | 220Ω±25% | 300Ω(Typ.) | 1A | 1A | 0.15Ω |
| BLM18EG331TN1□ | 330Ω±25% | 450Ω(Typ.) | 500mA | 500mA | 0.21Ω |
| BLM18EG391TN1□ | 390Ω±25% | 520Ω(Typ.) | 500mA | 500mA | 0.3Ω |

Operating Temp. Range: -55°C to 125°C

Z-f characteristics

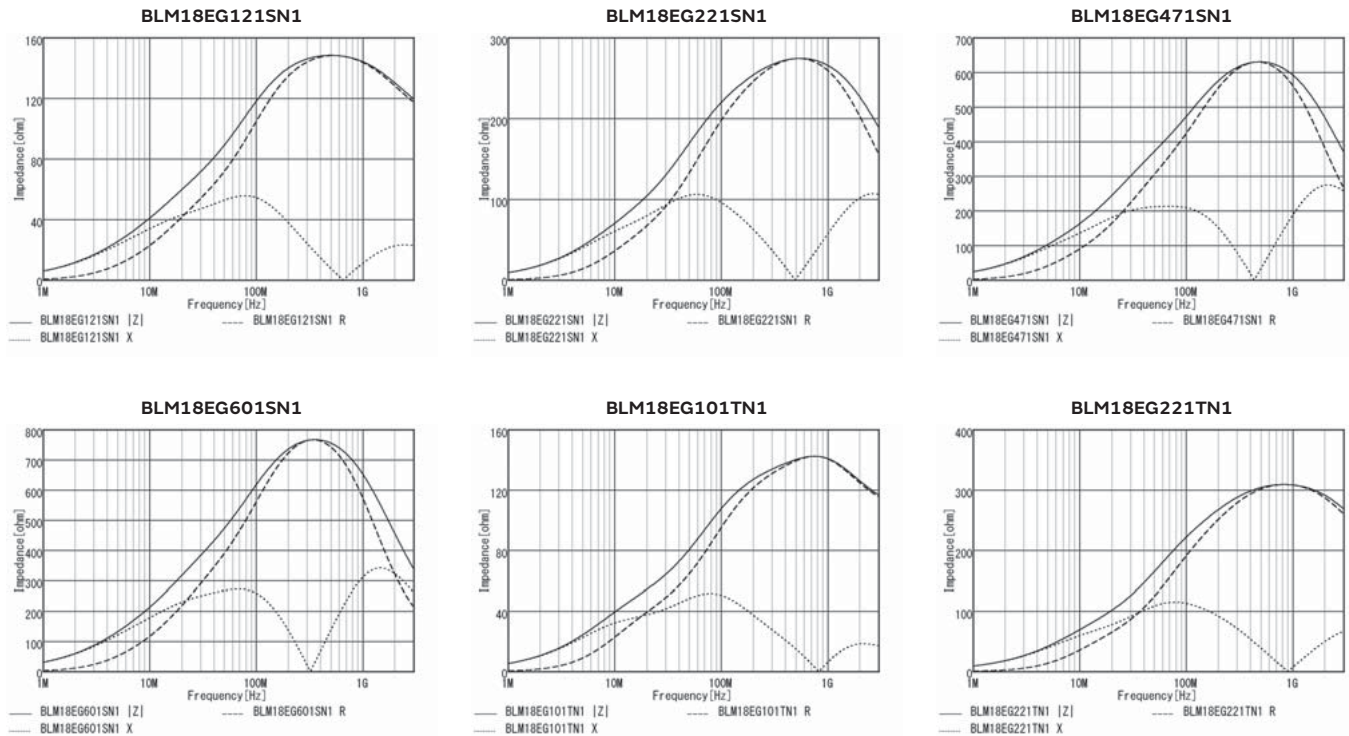

Continued on the following page. ↗

Continued from the preceding page. ↘

Z-f characteristics

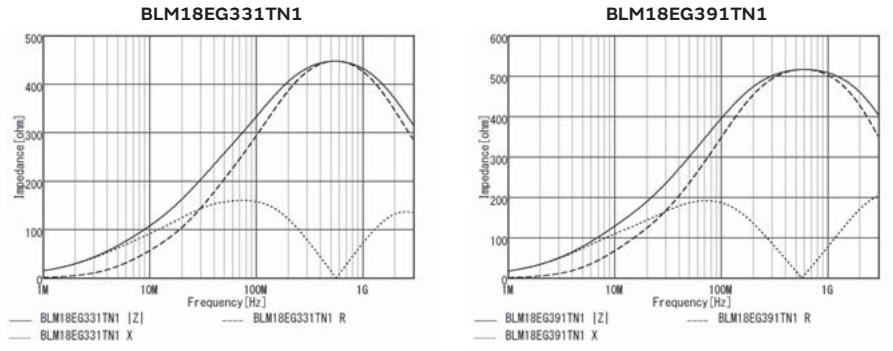

Derating of Rated Current

In operating temperature exceeding +85°C, derating of current is necessary for BLM18EG series.
 Please apply the derating curve shown in chart according to the operating temperature.

Derating of Rated Current

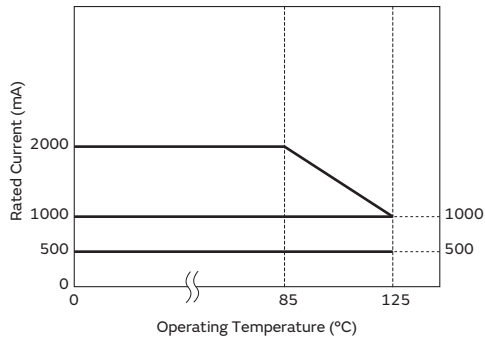

Chip ferrite bead

BLM18GG Series 0603/1608(inch/mm)

Appearance/Dimensions

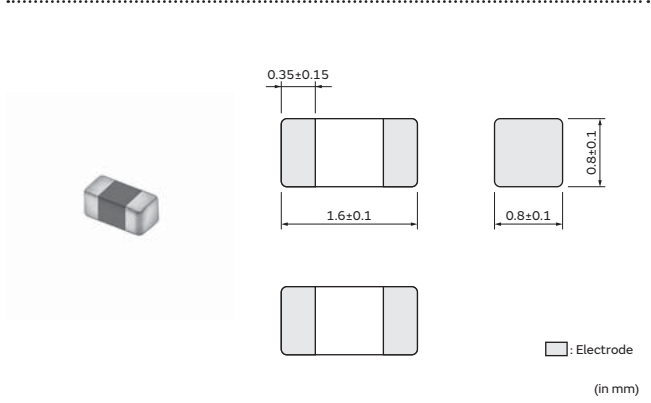

Packaging

| Code | Packaging | Minimum Quantity |
|------|-------------------|------------------|
| D | ø180mm Paper Tape | 4000 |
| J | ø330mm Paper Tape | 10000 |
| B | Bulk(Bag) | 1000 |

Equivalent Circuit

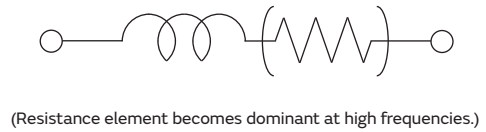

Rated Value (□: packaging code)

| Part Number | Impedance at 100MHz | Impedance at 1GHz | Rated Current at 85°C | Rated Current at 125°C | DC Resistance | Operating Temp. Range |
|----------------|---------------------|-------------------|-----------------------|------------------------|---------------|-----------------------|
| BLM18GG471SN1□ | 470Ω±25% | 1800Ω±30% | 200mA | 200mA | 1.3Ω | -55°C to 125°C |

Z-f characteristics

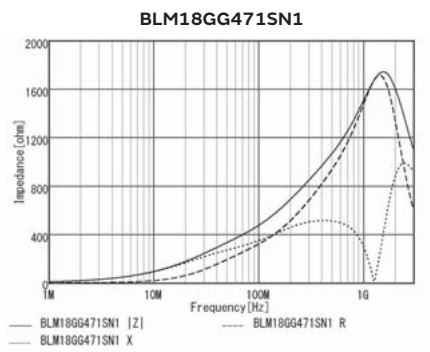

Chip Ferrite Bead (BLM/BLA/BLT) ⚠️Caution/Notice

⚠️Caution

Rating

1. About the Rated Current
 Do not use products beyond the rated current as this may create excessive heat and deteriorate the insulation resistance.
2. About Excessive Surge Current
 Surge current (pulse current or rush current) higher than

the specified rated current applied to the product may cause a critical failure, such as an open circuit or burnout caused by excessive temperature rise. Please contact us in advance in case of applying surge current.

Soldering and Mounting

- Self-heating
 Please pay special attention when mounting chip ferrite beads BLM_AX/P/K/S series BLT series in close proximity to other products that radiate heat.

The heat generated by other products may deteriorate the insulation resistance and cause excessive heat in this component.

Notice

Storage and Operating Conditions

<Operating Environment>

Do not use products in a corrodible atmosphere such as acidic gases, alkaline gases, chlorine, sulfur gases, organic gases (a sea breeze, Cl₂, H₂S, NH₃, SO₂, NO₂, etc.).
 Do not use products in an environment close to an organic solvent.

<Storage and Handling Requirements>

1. Storage Period
 BLM15E/15H/15G · BLT series should be used within 12

months; the other series should be used within 6 months. Solderability should be checked if this period is exceeded.

2. Storage Conditions

- (1) Storage temperature: -10 to +40°C
 Relative humidity: 15 to 85%
 Avoid sudden changes in temperature and humidity.
- (2) Do not store products in a chemical atmosphere such as chlorine gas, acid or sulfide gas.

Notice (Soldering and Mounting)

1. Cleaning
 Failure and degradation of a product can be caused by the cleaning method. When you clean in conditions that are not in the mounting information, please contact Murata engineering.
2. Soldering
 Reliability decreases with improper soldering methods. Please solder by the standard soldering conditions shown in the mounting information.

3. Other
 Noise suppression levels resulting from Murata's EMI suppression filters EMIFIL® may vary, depending on the circuits and ICs used, type of noise, mounting pattern, mounting location, and other operating conditions. Be sure to check and confirm in advance the noise suppression effect of each filter, in actual circuits, etc. before applying the filter in a commercial-purpose equipment design.

Handling

1. Resin Coating
 Using resin for coating/molding products may affect the product's performance.
 So please pay careful attention in selecting resin.
 Prior to use, please make a reliability evaluation with the product mounted in your application set.
2. Handling of Substrates
 After mounting products on a substrate, do not apply any stress to the product by bending or twisting the substrate

when cropping the substrate, inserting and removing a connector from the substrate or tightening a screw to the substrate.
 Excessive mechanical stress may cause cracking in the product.



Chip Ferrite Bead (BLM/BLA/BLT) Soldering and Mounting

1. Standard Land Pattern Dimensions

Land Pattern + Solder Resist
 Land Pattern
 Solder Resist
 (in mm)

Series

BLM02
BLM03
BLM15
BLM18
BLM21
BLM31
BLM41

●Reflow and Flow
 BLM Series

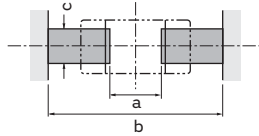

| Type | Soldering | a | b | c |
|-----------------------|-----------|------|------|-------|
| BLM02 | Reflow | 0.18 | 0.48 | 0.215 |
| BLM03 | Reflow | 0.25 | 0.8 | 0.3 |
| BLM15 | Reflow | 0.4 | 1.2 | 0.5 |
| BLM18 (except 18G) | Flow | 0.8 | 2.5 | 0.7 |
| | Reflow | 0.7 | 2.0 | |
| BLM21 | Flow | 1.1 | 3.5 | 0.95 |
| | Reflow | 1.2 | 2.4 | 1.25 |

• Except for BLM02PX/BLM03AX · P□ · EB/15AX · KD · PD · PG · PX · EX/18PG · KG · SG · SN/21PG · S□. And BLM02/03/15/18G is specially adapted for reflow soldering.

BLM□□AX/P/K/S/E

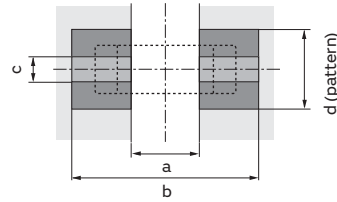

| Type | Rated Current (A) | Soldering | a | b | c | Land Pad Thickness and Dimension d | | | |
|-------------------------------|-------------------|-----------------|------------------------------|------------------------------|--------------------------------|------------------------------------|------|------|------|
| | | | | | | 18μm | 35μm | 70μm | |
| BLM02PX | 1.1max. | Reflow | 0.18 | 0.48 | 0.215 | 0.23 | 0.23 | 0.23 | |
| BLM03AX BLM03P□ BLM03EB | 0.9max. | Reflow | 0.25 | 0.8 | 0.3 | 0.3 | 0.3 | 0.3 | |
| | 1.8max. | | | | | 1.2 | 0.7 | 0.3 | |
| BLM15AX BLM15KD | 1.5max. | Reflow | 0.4 | 1.2 | 0.5 | 0.5 | 0.5 | 0.5 | |
| | 2.2max. | | | | | 1.2 | 0.7 | 0.5 | |
| BLM15PD BLM15PG BLM15PX | 3.0max. | Reflow | 0.4 | 1.2 | 0.5 | 2.4 | 1.2 | 0.5 | |
| | 1.3max. | | | | | 0.5 | 0.5 | 0.5 | |
| BLM15EX | 1.8max. | Reflow | 0.4 | 1.2 | 0.5 | 1.2 | 0.7 | 0.5 | |
| | 0.5-1.5 | | | | | 0.7 | 0.7 | 0.7 | |
| BLM18PG BLM18KG BLM18SG | 1.7-2.5 | Flow/ Reflow | Flow 0.8 Reflow 0.7 | Flow 2.5 Reflow 2.0 | Flow 0.7 Reflow 0.7 | 1.2 | 0.7 | 0.7 | |
| | | | | | | 3-4 | 2.4 | 1.2 | 0.7 |
| | | | | | | 5-6 | 6.4 | 3.3 | 1.65 |
| BLM18SN | 8 | | | | | - | 6.4 | 3.3 | |
| BLM21PG | 1.5 | Flow/ Reflow | Flow 1.1 Reflow 1.2 | Flow 3.5 Reflow 2.4 | Flow 0.95 Reflow 1.25 | 1.0 | 1.0 | 1.0 | |
| | 2 | | | | | 1.2 | 1.0 | 1.0 | |
| | 3-4 | | | | | 2.4 | 1.2 | 1.0 | |
| | 6 | | | | | 6.4 | 3.3 | 1.65 | |
| BLM21S□ | 6-8.5 | Flow Reflow | 1.1 1.2 | 3.5 2.4 | 0.95 1.25 | - | 6.8 | 3.4 | |
| | | | | | | 1.8 | 1.8 | 1.8 | |
| BLM31PG | 1.5-2 | Flow/ Reflow | Flow 2.4 Reflow 2 | Flow 4.7 Reflow 4.3 | Flow 1.2 Reflow 1.8 | 2.4 | 1.8 | 1.8 | |
| | 3.5 | | | | | 6.4 | 3.3 | 1.8 | |
| | 6 | | | | | 1.8 | 1.8 | 1.8 | |
| BLM31KN | 2 | Reflow | Flow 2.4 Reflow 2 | Flow 4.7 Reflow 4.3 | Flow 1.2 Reflow 1.8 | 2.4 | 1.8 | 1.8 | |
| | 2.5-2.9 | | | | | 6.4 | 3.3 | 1.8 | |
| | 4-6 | | | | | - | 9.8 | 4.9 | |
| BLM31SN | 10-12 | Flow/ Reflow | | | | - | 9.8 | 4.9 | |
| BLM41PG | 1.5-2 | Flow/ Reflow | 3 | 6.0 | 1.2 | 1.2 | 1.2 | 1.2 | |
| | 3.5 | | | | | 2.4 | 1.2 | 1.2 | |
| | 6 | | | | | 6.4 | 3.3 | 1.65 | |

• Do not apply narrower pattern than listed above to BLM□□AX/P/K/S. Narrow pattern can cause excessive heat or open circuit.

BLA2A
BLA31

●Reflow Soldering
 BLA2A

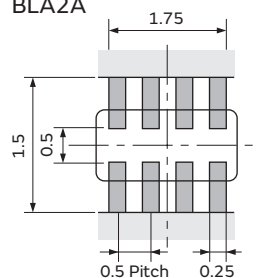

●Reflow and Flow
 BLA31

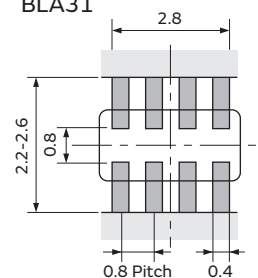

• If there are high amounts of self-heating on pattern, the contact points of PCB and part may become damaged.

Chip Ferrite Bead (BLM/BLA/BLT) Soldering and Mounting

Continued from the preceding page. ↘

(in mm)

| Series | Standard Land Dimensions |
|------------|--------------------------|
| BLT | <p>●Reflow Soldering</p> |

● PCB Warping

PCB should be designed so that products are not subjected to mechanical stress caused by warping the board.

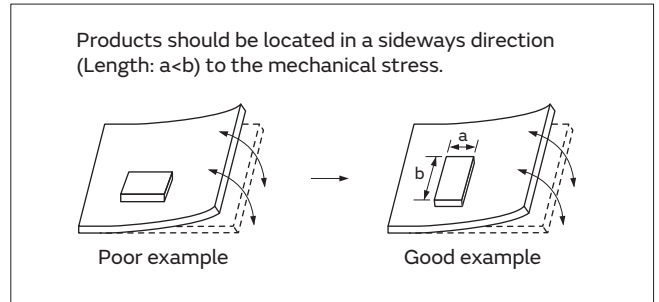

2. Solder Paste Printing and Adhesive Application

When reflow soldering the chip ferrite beads and bead inductors, the printing must be conducted in accordance with the following cream solder printing conditions. If too much solder is applied, the chip will be prone to damage by mechanical and thermal stress from the PCB and may crack. Standard land dimensions should be used for resist and copper foil patterns.

When flow soldering the chip ferrite beads and bead inductors, apply the adhesive in accordance with the following conditions.

If too much adhesive is applied, it may overflow into the land or termination areas and yield poor solderability. In contrast, if insufficient adhesive is applied, or if the adhesive is not sufficiently hardened, then the chip may become detached during the flow soldering process.

(in mm)

| Series | Solder Paste Printing | Adhesive Application |
|------------|--|---|
| BLM | <p>●Ensure that solder is applied smoothly to a minimum height of 0.2mm to 0.3mm at the end surface of the part.</p> <p>●Guideline of solder paste thickness: 50-80μm: BLM02 100-150μm: BLM03 100-200μm: BLM15/18/21/31/41</p> | <p>BLM18/21/31/41 Series (except for BLM18G Series) Coating amount is illustrated in the following diagram.</p> <p>a: 20-70μm b: 30-35μm c: 50-105μm</p> |
| BLA | <p>●Guideline of solder paste thickness: 100-150μm: BLA2A 150-200μm: BLA31</p> | <p>BLA31 Series Coating amount is illustrated in the following diagram.</p> <p>a: 20-70μm b: 30-35μm c: 50-105μm</p> |

Continued on the following page. ↗

Chip Ferrite Bead (BLM/BLA/BLT) Soldering and Mounting

Continued from the preceding page. ↘

(in mm)

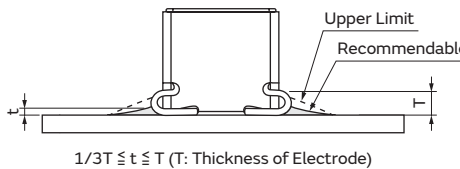
| Series | Solder Paste Printing | Adhesive Application |
|--------|---|----------------------|
| BLT | <ul style="list-style-type: none"> ● Solder shall be used not to exceed the upper limits as shown below. ● Guideline of solder paste thickness: 150µm: BLT5B  <p style="text-align: center;">$1/3T \leq t \leq T$ (T: Thickness of Electrode)</p> | |

3. Standard Soldering Conditions

(1) Soldering Methods

Use flow and reflow soldering methods only.
 Use standard soldering conditions when soldering chip ferrite beads and bead inductors.
 In cases where several different parts are soldered, each having different soldering conditions, use those conditions requiring the least heat and minimum time.

Solder: Use Sn-3.0Ag-0.5Cu solder. Use of Sn-Zn based solder will deteriorate performance of products.
 If using BLA series with Sn-Zn based solder, please contact Murata in advance.

Flux:

- Use rosin based flux.
 In case of using RA type solder, products should be cleaned completely with no residual flux.
- Do not use strong acidic flux (with chlorine content exceeding 0.20wt%)
- Do not use water-soluble flux.

For additional mounting methods, please contact Murata.

(2) Soldering Profile

- Flow Soldering Profile (Sn-3.0Ag-0.5Cu Solder)

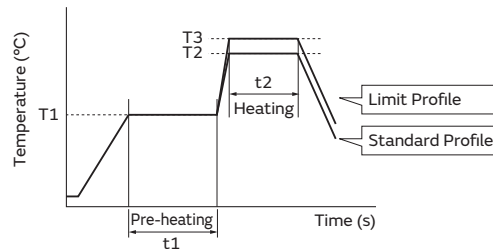

| Series | Pre-heating | | Standard Profile | | | Limit Profile | | |
|---|-------------|-----------|------------------|-----------|---------------|---------------|-----------|---------------|
| | Temp. (T1) | Time (t1) | Heating | | Cycle of Flow | Heating | | Cycle of Flow |
| | | | Temp. (T2) | Time (t2) | | Temp. (T3) | Time (t2) | |
| BLM (except for BLM02/03/15/18G) BLA31 | 150°C | 60s min. | 250°C | 4 to 6s | 2 times max. | 265±3°C | 5s max. | 2 times max. |

Continued on the following page. ↗

Chip Ferrite Bead (BLM/BLA/BLT) Soldering and Mounting

Continued from the preceding page. ↘

●Reflow Soldering Profile (Sn-3.0Ag-0.5Cu Solder)

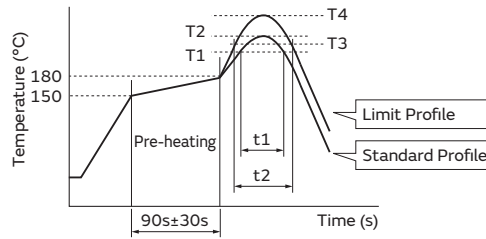

| Series | Standard Profile | | | | Limit Profile | | | |
|------------|------------------|-----------|-----------------------|-----------------|---------------|-----------|-----------------------|-----------------|
| | Heating | | Peak Temperature (T2) | Cycle of Reflow | Heating | | Peak Temperature (T4) | Cycle of Reflow |
| | Temp. (T1) | Time (t1) | | | Temp. (T3) | Time (t2) | | |
| BLM BLA | 220°C min. | 30 to 60s | 245±3°C | 2 times max. | 230°C min. | 60s max. | 260°C/10s | 2 times max. |
| BLT | | | | | 240°C min. | 30s max. | | |

(3) Reworking with a soldering Iron

The following conditions must be strictly followed when using a soldering iron (except for BLM02 Series).

Pre-heating: 150°C 60s min.

Soldering iron power output / Tip diameter:
 80W max. / ø3mm max.

Temperature of soldering iron tip / Soldering time / Times:

350°C max. / 3-4s / 2 times

Do not allow the tip of the soldering iron to directly contact the chip.

For additional methods of reworking with a soldering iron, please contact Murata engineering.

4. Cleaning

The following conditions should be observed when cleaning chip ferrite beads.

(1) Cleaning temperature: 60°C max. (40°C max. for alcohol type cleaner)

(2) Ultrasonic

Output: 20W/liter max.

Duration: 5 minutes max.

Frequency: 28 to 40kHz

(3) Cleaning Agent

The following cleaning agents have been tested on the individual components. Evaluation of final assembly should be completed prior to production.

Do not clean BLT series.

In case of cleaning, please contact Murata engineering.

(a) Alcohol cleaning agent

Isopropyl alcohol (IPA)

(b) Aqueous cleaning agent

Pine Alpha ST-100S

(4) Ensure that flux residue is completely removed.

The component should be thoroughly dried after the aqueous agent has been removed with deionized water.

(5) BLM_G type is processed with resin. On rinsing the product, using water for ultrasonic cleaning may affect the resin quality used for the product by water element. In case of set cleaning conditions, please make a reliability evaluation according to the cleaning conditions.

Chip Ferrite Bead (BLM/BLA/BLT) Packaging

Minimum Quantity and Dimensions of 8mm Width Paper / Embossed Tape

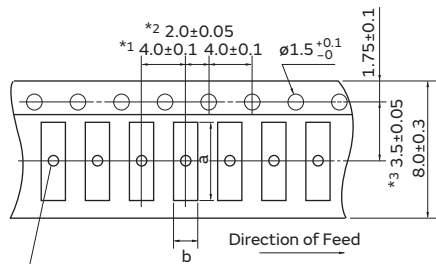

There are holes in the cavities of the BLM21BD222SN1/BD272SN1 and BLM31 only. $\phi 1.0 +0.3 -0$. BLE32 only. $\phi 1.0 +0.2 -0$.

- *1 BLM02/03/15: 2.0 ± 0.05
 BLA2A: 2.0 ± 0.1
 BLM18SG/TG: 2.0 ± 0.05
- *2 BLA2A/31: 2.0 ± 0.1
- *3 BLA2A/31: 3.5 ± 0.1

<Embossed>

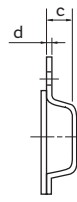

c: Depth of Cavity (Embossed Tape)

<Paper>

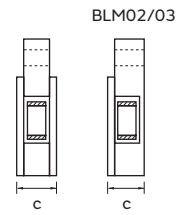

c: Total Thickness of Tape (Paper Tape)

Dimension of the cavity of embossed tape is measured at the bottom side.

| Part Number | Dimensions | | | | Minimum Qty. (pcs.) | | | | Bulk |
|----------------------------|------------|------|-----------|-----|--------------------------|---------------|--------------------------|---------------|------|
| | | | | | $\phi 180\text{mm}$ Reel | | $\phi 330\text{mm}$ Reel | | |
| | a | b | c | d | Paper Tape | Embossed Tape | Paper Tape | Embossed Tape | |
| BLM02 (except for BLM02KX) | 0.45 | 0.25 | 0.40 max. | - | 20000 | - | - | - | 1000 |
| BLM02KX | 0.45 | 0.25 | 0.52 max. | - | 15000 | - | - | - | 1000 |
| BLM03 | 0.66 | 0.36 | 0.55 max. | - | 15000 | - | 50000 | - | 1000 |
| BLM15 | 1.15 | 0.65 | 0.8 max. | - | 10000 | - | 50000 | - | 1000 |
| BLM18A/B/P/R/H/G | 1.85 | 1.05 | 1.1 max. | - | 4000 | - | 10000 | - | 1000 |
| BLM18EG/KG_TN | 1.85 | 1.05 | 0.85 max. | - | 4000 | - | 10000 | - | 1000 |
| BLM18EG/KG_SN | | | 1.1 max. | | | | | | |
| BLM18SD | 1.85 | 1.05 | 1.1 max. | - | 10000 | - | 30000 | - | 1000 |
| BLM18SG_SN1 | | | 0.85 max. | | | | | | |
| BLM18SN | | | 0.9 max. | | | | | | |
| BLM18SG_TN1 | | | 0.9 max. | | | | | | |
| BLM18T | 1.85 | 1.05 | 0.90 max. | - | 10000 | - | - | - | 1000 |
| BLM21 | 2.25 | 1.45 | 1.1 max. | - | 4000 | - | 10000 | - | 1000 |
| BLM31 (except for BLM31KN) | 3.5 | 1.9 | 1.3 | 0.2 | - | 3000 | - | 10000 | 1000 |
| BLM31KN | 3.5 | 1.9 | 1.75 | 0.2 | - | 2500 | - | 8000 | 1000 |
| BLM21BD222SN1/272SN1 | 2.25 | 1.45 | 1.3 | 0.2 | - | 3000 | - | 10000 | 1000 |
| BLA2A | 2.2 | 1.2 | 0.8 max. | - | 10000 | - | 50000 | - | 1000 |
| BLA31 | 3.4 | 1.8 | 1.1 max. | - | 4000 | - | 10000 | - | 1000 |

(in mm)

Continued on the following page. ↗

"Minimum Quantity" means the number of units of each delivery or order. The quantity should be an integral multiple of the "Minimum Quantity."

Chip Ferrite Bead (BLM/BLA/BLT) Packaging

Continued from the preceding page. ↘

Minimum Quantity and Dimensions of 12mm Width Embossed Tape

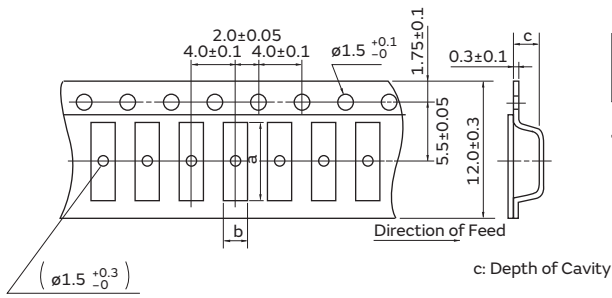

Dimension of the cavity is measured at the bottom side.

| Part Number | Dimensions | | | Minimum Qty. (pcs.) | | |
|--------------|------------|-----|------|---------------------|-------------|------|
| | a | b | c | φ180mm Reel | φ330mm Reel | Bulk |
| BLM41 | 4.8 | 1.9 | 1.75 | 2500 | 8000 | 1000 |

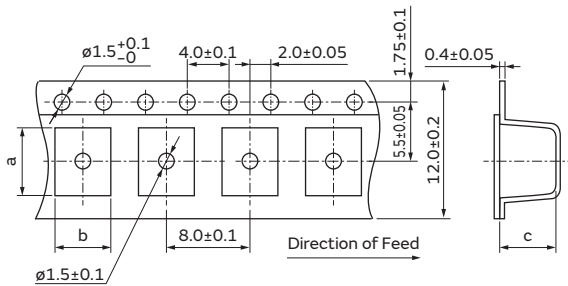

Dimension of the cavity is measured at the bottom side.

| Part Number | Dimensions | | | Minimum Qty. (pcs.) | | |
|--------------|------------|------|-----|---------------------|-------------|------|
| | a | b | c | φ180mm Reel | φ330mm Reel | Bulk |
| BLT5B | 6.5 | 5.35 | 0.4 | 300 | - | 50 |

(in mm)

"Minimum Quantity" means the number of units of each delivery or order. The quantity should be an integral multiple of the "Minimum Quantity."

Application Specified Noise Filter NFZ_S/NFZ_B/BLF/BLE/LQW_CA Series

| | |
|---|------|
| Part Numbering | p118 |
| Series Lineup | p122 |
| Product Detail | |
| Noise filter for audio lines | p126 |
| Noise filter for LED lighting equipment | p133 |
| Frequency specified noise filter | p142 |
| Noise filter for power charger lines | p145 |
| Inductor for audio line noise suppression | p147 |
| ⚠Caution/Notice | p151 |
| Soldering and Mounting | p154 |
| Packaging | p160 |

● Part Numbering

Chip EMIFIL®

(Part Number)

| | | | | | | | | | |
|----|---|----|----|-----|---|---|---|---|---|
| NF | Z | 32 | BW | 3R6 | H | N | 1 | 0 | L |
| ① | ② | ③ | ④ | ⑤ | ⑥ | ⑦ | ⑧ | ⑨ | ⑩ |

① Product ID

| Product ID | |
|------------|--------------|
| NF | Chip EMIFIL® |

② Structure

| Code | Structure |
|------|---------------|
| Z | Inductor Type |

③ Dimensions (LxW)

| Code | Dimensions (LxW) | Size Code (inch) |
|------|------------------|------------------|
| 03 | 0.6x0.3mm | 0201 |
| 15 | 1.0x0.5mm | 0402 |
| 18 | 1.6x0.8mm | 0603 |
| 2M | 2.0x1.6mm | 0806 |
| 2H | 2.5x2.0mm | 1008 |
| 32 | 3.2x2.5mm | 1210 |
| 5B | 5.0x5.0mm | 2020 |

④ Features

| Code | Features |
|------|--|
| SM | For Audio Lines Multilayer Type |
| SW | For Audio Lines Wire Wound Type |
| BW | For LED Lines Wire Wound Type |
| BM | For LED Lines Multilayer Type |
| SG | For Audio Lines Multilayer Type (For GHz Band Use) |

⑤ Impedance

Expressed by three figures. The unit is in ohm (Ω). The first and second figures are significant digits, and the third figure expresses the number of zeros that follow the two figures.

⑥ Inductance Tolerance

| Code | Features |
|------|--------------------------------|
| S | For General Use (Sn Plating) |
| H | For General Use (LF Solder) *1 |
| L | For General Use (LF Solder) |

*1 NFZ32SW/32BW_H□1 only.

⑦ Category

| Code | Category |
|------|---------------------|
| N | For General-Purpose |

⑧ Number of Circuits

| Code | Number of Circuits |
|------|--------------------|
| 1 | 1 Circuit |

⑨ Specification

| Code | Specification |
|------|---------------|
| 0 | Standard Type |
| 1 | Low Rdc Type |

⑩ Packaging

| Code | Packaging |
|------|---|
| K | Embossed Taping (\varnothing 330mm Reel) |
| L | Embossed Taping (\varnothing 180mm Reel) |
| B | Bulk |
| D | Paper Taping (\varnothing 180mm Reel) |

Frequency Specified Filters

(Part Number)

| | | | | | | | | |
|-----|----|---|---|-----|---|---|---|---|
| BLF | 03 | J | D | 421 | G | N | E | D |
| ① | ② | ③ | ④ | ⑤ | ⑥ | ⑦ | ⑧ | ⑨ |

① Product ID

| Code | |
|------|-----------------------------|
| BLF | Frequency Specified Filters |

② Dimensions (LxW)

| Code | Dimensions (LxW) | Size Code (inch) |
|------|------------------|------------------|
| 02 | 0.4×0.2mm | 01005 |
| 03 | 0.6×0.3mm | 0201 |

③ Target Frequency

| Code | Target Frequency |
|------|------------------|
| J | 700MHz |
| R | 2.4GHz |
| V | 5GHz |

④ Characteristics Classification

⑤ Impedance at Target Frequency

Expressed by three figures. The unit is in ohm (Ω).
 The first and second figures are significant digits, and the third figure expresses the number of zeros that follow the two figures.

⑥ Chip Shape/Electrode

Expressed by a letter.

| Code | Chip Shape/Electrode |
|------|---|
| G | High Profile (Sn Plating/5 Surface Electrode) |
| S | Standard (Sn Plating/5 Surface Electrode) |

⑦ Category

| Code | Category |
|------|---------------------|
| N | For General-Purpose |

⑧ Rated Current

| Code | Rated Current |
|------|---------------|
| E | 500mA max. |
| G | 1A max. |
| L | 2A max. |

⑨ Packaging

| Code | Packaging |
|------|---|
| E | Embossed Taping (\varnothing 180mm Reel*1) |
| B | Bulk |
| D | Paper Taping (\varnothing 180mm Reel) |

*1 Width 8mm

Chip Power Bead

(Part Number)

| | | | | | | | |
|-----|----|----|-----|---|---|---|---|
| BLE | 18 | PS | 080 | S | N | 1 | D |
| ① | ② | ③ | ④ | ⑤ | ⑥ | ⑦ | ⑧ |

① Product ID

| Product ID | |
|------------|--------------------|
| BLE | Chip Ferrite Beads |

② Dimensions (LxW)

| Code | Dimensions (LxW) | Size Code (inch) |
|-----------|------------------|------------------|
| 18 | 1.6x0.8mm | 0603 |
| 32 | 3.2x2.5mm | 1210 |

③ Characteristics/Applications

| Code ^{*1} | Characteristics/Applications |
|--------------------|------------------------------|
| PN | For Power Lines |
| PS | |

*1 Frequency characteristics vary with each code.

④ Impedance

Expressed by three figures. The unit is in ohm (Ω) at 100MHz. The first and second figures are significant digits, and the third figure expresses the number of zeros that follow the two figures.

⑤ Electrode

Expressed by a letter.

Ex.)

| Code | Electrode |
|----------|------------|
| S | Sn Plating |

⑥ Category

| Code | Category |
|----------|---------------------|
| N | For General-Purpose |

⑦ Number of Circuits

| Code | Number of Circuits |
|----------|--------------------|
| 1 | 1 Circuit |

⑧ Packaging

| Code | Packaging |
|----------|---|
| K | Embossed Taping (\varnothing 330mm Reel) |
| L | Embossed Taping (\varnothing 180mm Reel) |
| B | Bulk |
| J | Paper Taping (\varnothing 330mm Reel) |
| D | Paper Taping (\varnothing 180mm Reel) |

Inductors for General Circuits

(Part Number)

| | | | | | | | | | |
|----|---|----|---|---|-----|---|---|---|---|
| LQ | W | 04 | C | A | R45 | K | 0 | 0 | D |
| ① | ② | ③ | ④ | ⑤ | ⑥ | ⑦ | ⑧ | ⑨ | ⑩ |

① Product ID

| Product ID | |
|------------|-----------------------------|
| LQ | Chip Inductors (Chip Coils) |

② Structure

| Code | Structure |
|------|--------------------------------|
| W | Wire Wound Type (Ferrite Core) |

② Dimensions (LxW)

| Code | Nominal Dimensions (LxW) | Size Code (in inch) |
|------|--------------------------|---------------------|
| 04 | 0.8x0.4mm | 03019 |
| 15 | 1.0x0.5mm | 0402 |
| 18 | 1.6x0.8mm | 0603 |

④ Applications and Characteristics

| Code | Series | Applications and Characteristics |
|------|--------|----------------------------------|
| C | LQW | for Choke |

⑤ Category

| Code | Category | |
|------|----------|----------------------------------|
| A | General | Impedance Device (Near GHz Band) |

⑥ Inductance

Expressed by three-digit alphanumerics. The unit is micro-henry (μH). The first and second figures are significant digits, and the third figure expresses the number of zeros that follow the two figures. If there is a decimal point, it is expressed by the capital letter "R." In this case, all figures are significant digits. If inductance is less than $0.1\mu\text{H}$, the inductance code is expressed by a combination of two figures and the capital letter "N," and the unit of inductance is nano-henry (nH). The capital letter "N" indicates the unit of "nH," and also expresses a decimal point. In this case, all figures are significant digits.

⑦ Inductance Tolerance

| Code | Inductance Tolerance |
|------|----------------------|
| J | $\pm 5\%$ |
| K | $\pm 10\%$ |

⑧ Features

| Code | Features | Series |
|------|---------------|--------|
| 0 | Standard Type | LQW |

⑨ Electrode

•Lead (Pb) Free

| Code | Electrode | Series |
|------|-----------|--------|
| 0 | Sn | LQW |

⑩ Packaging

| Code | Packaging |
|------|--|
| B | Bulk |
| J | Paper Taping ($\phi 330\text{mm}$ Reel) |
| D | Paper Taping ($\phi 180\text{mm}$ Reel) |

Series Lineup

NFZ_S

Noise filter for audio lines

| Size Code in inches (mm) | Thickness (mm) | Part Number | Impedance | | | | Rated Current |
|-----------------------------|-------------------|--------------------------------|-----------|-------------|--------------|--------------|------------------|
| | | | at 1MHz | at 100MHz | at 900MHz | at 1.7GHz | |
| 0201 (0603) | 0.3 | NFZ03SG331SN10 ^{p126} | - | - | 330Ω (Typ.) | 400Ω (Typ.) | 305mA |
| | 0.3 | NFZ03SG501SN10 ^{p126} | - | - | 500Ω (Typ.) | 600Ω (Typ.) | 275mA |
| | 0.3 | NFZ03SG671SN10 ^{p126} | - | - | 670Ω (Typ.) | 800Ω (Typ.) | 250mA |
| | 0.3 | NFZ03SG102SN10 ^{p126} | - | - | 1000Ω (Typ.) | 900Ω (Typ.) | 210mA |
| | 0.3 | NFZ03SG162SN10 ^{p126} | - | - | 1600Ω (Typ.) | 1200Ω (Typ.) | 180mA |
| 0402 (1005) | 0.5 | NFZ15SG771SN10 ^{p127} | - | - | 770Ω (Typ.) | 900Ω (Typ.) | 500mA |
| | 0.5 | NFZ15SG152SN10 ^{p127} | - | - | 1500Ω (Typ.) | 1200Ω (Typ.) | 400mA |
| | 0.5 | NFZ15SG262SN10 ^{p127} | - | - | 2600Ω (Typ.) | 1450Ω (Typ.) | 350mA |
| | 0.5 | NFZ15SG462SN10 ^{p127} | - | - | 4600Ω (Typ.) | 1800Ω (Typ.) | 270mA |
| | 0.5 | NFZ15SG101SN11 ^{p127} | - | - | 100Ω (Typ.) | 160Ω (Typ.) | 1.1A |
| | 0.5 | NFZ15SG151SN11 ^{p127} | - | - | 150Ω (Typ.) | 250Ω (Typ.) | 1A |
| | 0.5 | NFZ15SG331SN11 ^{p127} | - | - | 330Ω (Typ.) | 540Ω (Typ.) | 650mA |
| 0603 (1608) | 0.8 | NFZ18SM121SN10 ^{p129} | - | 120Ω±25% | - | - | 1.25A |
| | 0.8 | NFZ18SM251SN10 ^{p129} | - | 250Ω±25% | - | - | 1.1A |
| | 0.8 | NFZ18SM501SN10 ^{p129} | - | 500Ω±25% | - | - | 950mA |
| | 0.8 | NFZ18SM701SN10 ^{p129} | - | 700Ω±25% | - | - | 800mA |
| 0806 (2016) | 0.9 | NFZ2MSM101SN10 ^{p131} | - | 100Ω±25% | - | - | 4A |
| | 0.9 | NFZ2MSM181SN10 ^{p131} | - | 180Ω±25% | - | - | 3.4A |
| | 0.9 | NFZ2MSM301SN10 ^{p131} | - | 300Ω±25% | - | - | 3.1A |
| | 0.9 | NFZ2MSM601SN10 ^{p131} | - | 600Ω±25% | - | - | 2.5A |
| 1210 (3225) | 1.55 | NFZ32SW301HN10 ^{p132} | 3.2Ω±30% | 300Ω (Typ.) | - | - | 2.55A |
| | 1.55 | NFZ32SW901HN10 ^{p132} | 6.8Ω±30% | 900Ω (Typ.) | - | - | 2.05A |

NFZ_B

Noise filter for LED lighting equipment

| Size Code in inches (mm) | Thickness (mm) | Part Number | Impedance (at 1MHz) | Rated Current |
|-----------------------------|-------------------|--------------------------------|------------------------|---------------|
| 1008 (2520) | 0.9 | NFZ2HBM1R5SN10 ^{p133} | 1.5Ω±30% | 1.2A |
| | 0.9 | NFZ2HBM2R9SN10 ^{p133} | 2.9Ω±30% | 1.1A |
| | 0.9 | NFZ2HBM4R4SN10 ^{p133} | 4.4Ω±30% | 1.05A |
| | 0.9 | NFZ2HBM6R1SN10 ^{p133} | 6.1Ω±30% | 1A |
| | 0.9 | NFZ2HBM8R4SN10 ^{p133} | 8.4Ω±30% | 900mA |
| | 0.9 | NFZ2HBM110SN10 ^{p133} | 11Ω±30% | 800mA |
| | 0.9 | NFZ2HBM170SN10 ^{p133} | 17Ω±30% | 700mA |
| | 0.9 | NFZ2HBM240SN10 ^{p133} | 24Ω±30% | 650mA |
| | 0.9 | NFZ2HBM330SN10 ^{p133} | 33Ω±30% | 500mA |
| | 0.9 | NFZ2HBM600SN10 ^{p133} | 60Ω±30% | 400mA |
| 1210 (3225) | 1.55 | NFZ32BW3R6HN10 ^{p135} | 3.6Ω±30% | 2.55A |
| | 1.55 | NFZ32BW7R4HN10 ^{p135} | 7.4Ω±30% | 2.05A |
| | 1.55 | NFZ32BW9R0HN10 ^{p135} | 9Ω±30% | 1.75A |
| | 1.55 | NFZ32BW150HN10 ^{p135} | 15Ω±30% | 1.6A |
| | 1.55 | NFZ32BW210HN10 ^{p135} | 21Ω±30% | 1.2A |
| | 1.55 | NFZ32BW320HN10 ^{p135} | 32Ω±30% | 1A |
| | 1.55 | NFZ32BW420HN10 ^{p135} | 42Ω±30% | 850mA |
| | 1.55 | NFZ32BW700HN10 ^{p135} | 70Ω±30% | 700mA |
| | 1.55 | NFZ32BW111HN10 ^{p135} | 110Ω±30% | 520mA |
| | 1.55 | NFZ32BW151HN10 ^{p135} | 150Ω±30% | 450mA |
| | 1.55 | NFZ32BW221HN10 ^{p135} | 220Ω±30% | 390mA |
| | 1.55 | NFZ32BW291HN10 ^{p135} | 290Ω±30% | 310mA |

Continued on the following page. ↗

| Size Code in inches (mm) | Thickness (mm) | Part Number | Impedance (at 1MHz) | Rated Current |
|-----------------------------|--------------------------------|--------------------------------|------------------------|---------------|
| 1210 (3225) | 1.55 | NFZ32BW451HN10 ^{p135} | 450Ω±30% | 275mA |
| | 1.55 | NFZ32BW621HN10 ^{p135} | 620Ω±30% | 250mA |
| | 1.55 | NFZ32BW881HN10 ^{p135} | 880Ω±30% | 200mA |
| | 1.55 | NFZ32BW3R3HN11 ^{p135} | 3.3Ω±30% | 2.9A |
| | 1.55 | NFZ32BW6R8HN11 ^{p135} | 6.8Ω±30% | 2.5A |
| | 1.55 | NFZ32BW8R4HN11 ^{p135} | 8.4Ω±30% | 2.4A |
| | 1.55 | NFZ32BW9R8HN11 ^{p135} | 9.8Ω±30% | 2.1A |
| | 1.55 | NFZ32BW120HN11 ^{p136} | 12Ω±30% | 1.85A |
| | 1.55 | NFZ32BW190HN11 ^{p136} | 19Ω±30% | 1.8A |
| | 1.55 | NFZ32BW210HN11 ^{p136} | 21Ω±30% | 1.55A |
| | 1.55 | NFZ32BW310HN11 ^{p136} | 31Ω±30% | 1.2A |
| | 1.55 | NFZ32BW520HN11 ^{p136} | 52Ω±30% | 1.1A |
| | 1.55 | NFZ32BW650HN11 ^{p136} | 65Ω±30% | 900mA |
| | 1.55 | NFZ32BW101HN11 ^{p136} | 100Ω±30% | 900mA |
| 1.55 | NFZ32BW151HN11 ^{p136} | 150Ω±30% | 700mA | |
| 2020 (5050) | 2.0 | NFZ5BBW2R9LN10 ^{p139} | 2.9Ω±30% | 4A |
| | 2.0 | NFZ5BBW4R5LN10 ^{p139} | 4.5Ω±30% | 3.4A |
| | 2.0 | NFZ5BBW6R7LN10 ^{p139} | 6.7Ω±30% | 3.1A |
| | 2.0 | NFZ5BBW7R6LN10 ^{p139} | 7.6Ω±30% | 3.1A |
| | 2.0 | NFZ5BBW100LN10 ^{p139} | 10Ω±30% | 3A |
| | 2.0 | NFZ5BBW140LN10 ^{p139} | 14Ω±30% | 2.6A |
| | 2.0 | NFZ5BBW170LN10 ^{p139} | 17Ω±30% | 2.5A |
| | 2.0 | NFZ5BBW220LN10 ^{p139} | 22Ω±30% | 2.3A |
| | 2.0 | NFZ5BBW310LN10 ^{p139} | 31Ω±30% | 2A |
| | 2.0 | NFZ5BBW450LN10 ^{p139} | 45Ω±30% | 1.65A |
| | 2.0 | NFZ5BBW520LN10 ^{p139} | 52Ω±30% | 1.61A |
| | 2.0 | NFZ5BBW610LN10 ^{p139} | 61Ω±30% | 1.6A |
| | 2.0 | NFZ5BBW970LN10 ^{p139} | 97Ω±30% | 1.2A |
| | 2.0 | NFZ5BBW141LN10 ^{p139} | 140Ω±30% | 1.05A |

BLF

Frequency specified noise filter

| Size Code in inches (mm) | Thickness (mm) | Part Number | Target Frequency | Impedance | Rated Current |
|-----------------------------|-------------------|-------------------------------|------------------|-----------|---------------|
| 01005 (0402) | 0.3 | BLF02JD361GNE ^{p142} | 700MHz | 360Ω±40% | 380mA |
| | 0.3 | BLF02JD471GNE ^{p142} | 700MHz | 470Ω±40% | 330mA |
| | 0.3 | BLF02RD331GNE ^{p143} | 2.4GHz | 330Ω±40% | 330mA |
| | 0.3 | BLF02RD471GNE ^{p143} | 2.4GHz | 470Ω±40% | 200mA |
| 0201 (0603) | 0.4 | BLF03JD421GNE ^{p144} | 700MHz | 420Ω±40% | 480mA |

BLE

Noise filter for power charger lines

| Size Code in inches (mm) | Thickness (mm) | Part Number | Impedance (at 100MHz) | Rated Current |
|-----------------------------|-------------------|-------------------------------|--------------------------|---------------|
| 0603 (1608) | 0.6 | BLE18PS080SN1 ^{p145} | 8.5Ω±25% | 8A |
| 1210 (3225) | 1.5 | BLE32PN260SN1 ^{p146} | 26Ω±10Ω | 10A |
| | 2.0 | BLE32PN300SN1 ^{p146} | 30Ω±10Ω | 10A |

LQW_CA

Inductor for audio line noise suppression

| Size Code in inches (mm) | Thickness (mm) | Part Number | Inductance | Rated Current | Max. of DC Resistance | S.R.F.* (min.) |
|--------------------------|-------------------------------|-------------------------------|------------|---------------|-----------------------|----------------|
| 03019 (0805) | 0.5 | LQW04CA60NK00 ^{p147} | 60nH±10% | 620mA | 0.18Ω | 3000MHz |
| | 0.5 | LQW04CA90NK00 ^{p147} | 90nH±10% | 520mA | 0.24Ω | 2500MHz |
| | 0.5 | LQW04CAR12K00 ^{p147} | 120nH±10% | 510mA | 0.28Ω | 2100MHz |
| | 0.5 | LQW04CAR29K00 ^{p147} | 290nH±10% | 270mA | 0.94Ω | 1400MHz |
| | 0.5 | LQW04CAR45K00 ^{p147} | 450nH±10% | 200mA | 1.23Ω | 850MHz |
| | 0.5 | LQW04CAR51K00 ^{p147} | 510nH±10% | 200mA | 1.31Ω | 700MHz |
| 0402 (1005) | 0.56 | LQW15CA22NJ00 ^{p148} | 22nH±5% | 1300mA | 0.06Ω | 3000MHz |
| | 0.56 | LQW15CA22NK00 ^{p148} | 22nH±10% | 1300mA | 0.06Ω | 3000MHz |
| | 0.56 | LQW15CA39NJ00 ^{p148} | 39nH±5% | 1100mA | 0.075Ω | 2700MHz |
| | 0.56 | LQW15CA39NK00 ^{p148} | 39nH±10% | 1100mA | 0.075Ω | 2700MHz |
| | 0.56 | LQW15CA59NJ00 ^{p148} | 59nH±5% | 1000mA | 0.095Ω | 2300MHz |
| | 0.56 | LQW15CA59NK00 ^{p148} | 59nH±10% | 1000mA | 0.095Ω | 2300MHz |
| | 0.56 | LQW15CA83NJ00 ^{p148} | 83nH±5% | 970mA | 0.12Ω | 1700MHz |
| | 0.56 | LQW15CA83NK00 ^{p148} | 83nH±10% | 970mA | 0.12Ω | 1700MHz |
| | 0.56 | LQW15CAR11J00 ^{p148} | 110nH±5% | 900mA | 0.13Ω | 1600MHz |
| | 0.56 | LQW15CAR11K00 ^{p148} | 110nH±10% | 900mA | 0.13Ω | 1600MHz |
| | 0.56 | LQW15CAR14J00 ^{p148} | 140nH±5% | 680mA | 0.18Ω | 1400MHz |
| | 0.56 | LQW15CAR14K00 ^{p148} | 140nH±10% | 680mA | 0.18Ω | 1400MHz |
| | 0.56 | LQW15CAR18J00 ^{p148} | 180nH±5% | 640mA | 0.21Ω | 1300MHz |
| | 0.56 | LQW15CAR18K00 ^{p148} | 180nH±10% | 640mA | 0.21Ω | 1300MHz |
| | 0.56 | LQW15CAR22J00 ^{p148} | 220nH±5% | 540mA | 0.29Ω | 1300MHz |
| | 0.56 | LQW15CAR22K00 ^{p148} | 220nH±10% | 540mA | 0.29Ω | 1300MHz |
| | 0.56 | LQW15CAR27J00 ^{p148} | 270nH±5% | 480mA | 0.38Ω | 1200MHz |
| | 0.56 | LQW15CAR27K00 ^{p149} | 270nH±10% | 480mA | 0.38Ω | 1200MHz |
| | 0.56 | LQW15CAR32J00 ^{p149} | 320nH±5% | 420mA | 0.41Ω | 1100MHz |
| | 0.56 | LQW15CAR32K00 ^{p149} | 320nH±10% | 420mA | 0.41Ω | 1100MHz |
| | 0.56 | LQW15CAR37J00 ^{p149} | 370nH±5% | 360mA | 0.575Ω | 1000MHz |
| | 0.56 | LQW15CAR37K00 ^{p149} | 370nH±10% | 360mA | 0.575Ω | 1000MHz |
| | 0.56 | LQW15CAR39J00 ^{p149} | 390nH±5% | 320mA | 0.72Ω | 950MHz |
| | 0.56 | LQW15CAR39K00 ^{p149} | 390nH±10% | 320mA | 0.72Ω | 950MHz |
| | 0.56 | LQW15CAR43J00 ^{p149} | 430nH±5% | 360mA | 0.68Ω | 920MHz |
| | 0.56 | LQW15CAR43K00 ^{p149} | 430nH±10% | 360mA | 0.68Ω | 920MHz |
| | 0.56 | LQW15CAR50J00 ^{p149} | 500nH±5% | 270mA | 0.97Ω | 900MHz |
| | 0.56 | LQW15CAR50K00 ^{p149} | 500nH±10% | 270mA | 0.97Ω | 900MHz |
| | 0.56 | LQW15CAR56J00 ^{p149} | 560nH±5% | 270mA | 1.00Ω | 900MHz |
| | 0.56 | LQW15CAR56K00 ^{p149} | 560nH±10% | 270mA | 1.00Ω | 900MHz |
| | 0.56 | LQW15CAR64J00 ^{p149} | 640nH±5% | 240mA | 1.40Ω | 870MHz |
| | 0.56 | LQW15CAR64K00 ^{p149} | 640nH±10% | 240mA | 1.40Ω | 870MHz |
| 0.56 | LQW15CAR73J00 ^{p149} | 730nH±5% | 200mA | 1.95Ω | 810MHz | |
| 0.56 | LQW15CAR73K00 ^{p149} | 730nH±10% | 200mA | 1.95Ω | 810MHz | |
| 0.56 | LQW15CAR80J00 ^{p149} | 800nH±5% | 190mA | 2.10Ω | 770MHz | |
| 0.56 | LQW15CAR80K00 ^{p149} | 800nH±10% | 190mA | 2.10Ω | 770MHz | |
| 0.56 | LQW15CA1R0K00 ^{p149} | 1000nH±10% | 180mA | 2.20Ω | 400MHz | |
| 0.56 | LQW15CA2R0K00 ^{p149} | 2000nH±10% | 130mA | 3.20Ω | 120MHz | |
| 0603 (1608) | 0.8 | LQW18CA32NJ00 ^{p150} | 32nH±5% | 2200mA | 0.030Ω | 3000MHz |
| | 0.8 | LQW18CA56NJ00 ^{p150} | 56nH±5% | 1850mA | 0.040Ω | 2200MHz |
| | 0.8 | LQW18CA85NJ00 ^{p150} | 85nH±5% | 1650mA | 0.048Ω | 1800MHz |
| | 0.8 | LQW18CAR12J00 ^{p150} | 120nH±5% | 1500mA | 0.058Ω | 1500MHz |
| | 0.8 | LQW18CAR16J00 ^{p150} | 160nH±5% | 1300mA | 0.075Ω | 1350MHz |
| | 0.8 | LQW18CAR21J00 ^{p150} | 210nH±5% | 1050mA | 0.115Ω | 1150MHz |
| | 0.8 | LQW18CAR27J00 ^{p150} | 270nH±5% | 900mA | 0.150Ω | 1050MHz |

*S.R.F.: Self-Resonant Frequency

Continued on the following page. ↗

| Size Code in inches (mm) | Thickness (mm) | Part Number | Inductance | Rated Current | Max. of DC Resistance | S.R.F.* (min.) |
|-----------------------------|-------------------|---------------------------|------------|---------------|-----------------------|----------------|
| 0603 (1608) | 0.8 | LQW18CAR33J00 p150 | 330nH±5% | 780mA | 0.200Ω | 970MHz |
| | 0.8 | LQW18CAR40J00 p150 | 400nH±5% | 680mA | 0.260Ω | 900MHz |
| | 0.8 | LQW18CAR48J00 p150 | 480nH±5% | 580mA | 0.350Ω | 800MHz |
| | 0.8 | LQW18CAR58J00 p150 | 580nH±5% | 450mA | 0.460Ω | 760MHz |

*S.R.F.: Self-Resonant Frequency

Chip Ferrite Bead

Application Specified Noise Filter

Chip EMIFIL®

Common Mode Choke Coil
 · Common Mode Noise Filter

Block Type EMIFIL®

EMC Absorber

Application specified noise filter

NFZ03SG Series 0201/0603(inch/mm)

Noise filter for audio lines

Appearance/Dimensions

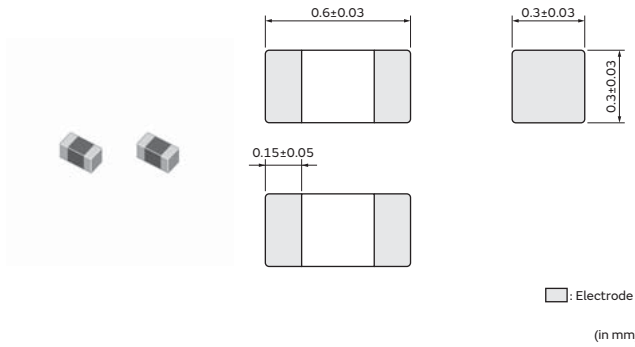

Packaging

| Code | Packaging | Minimum Quantity |
|------|-------------------|------------------|
| D | ø180mm Paper Tape | 15000 |
| B | Bulk(Bag) | 1000 |

Equivalent Circuit



(Resistance element becomes dominant at high frequencies.)

Rated Value (□: packaging code)

| Part Number | Impedance at 900MHz | Impedance at 1.7GHz | Rated Current | DC Resistance | DC Resistance (Max.) |
|-----------------|---------------------|---------------------|---------------|---------------|----------------------|
| NFZ03SG331SN10□ | 330Ω(Typ.) | 400Ω(Typ.) | 305mA | 0.46Ω (Typ.) | 0.6Ω |
| NFZ03SG501SN10□ | 500Ω(Typ.) | 600Ω(Typ.) | 275mA | 0.56Ω (Typ.) | 0.73Ω |
| NFZ03SG671SN10□ | 670Ω(Typ.) | 800Ω(Typ.) | 250mA | 0.69Ω (Typ.) | 0.88Ω |
| NFZ03SG102SN10□ | 1000Ω(Typ.) | 900Ω(Typ.) | 210mA | 1Ω (Typ.) | 1.3Ω |
| NFZ03SG162SN10□ | 1600Ω(Typ.) | 1200Ω(Typ.) | 180mA | 1.3Ω (Typ.) | 1.7Ω |

Operating Temp. Range: -55°C to 125°C

Z-f characteristics

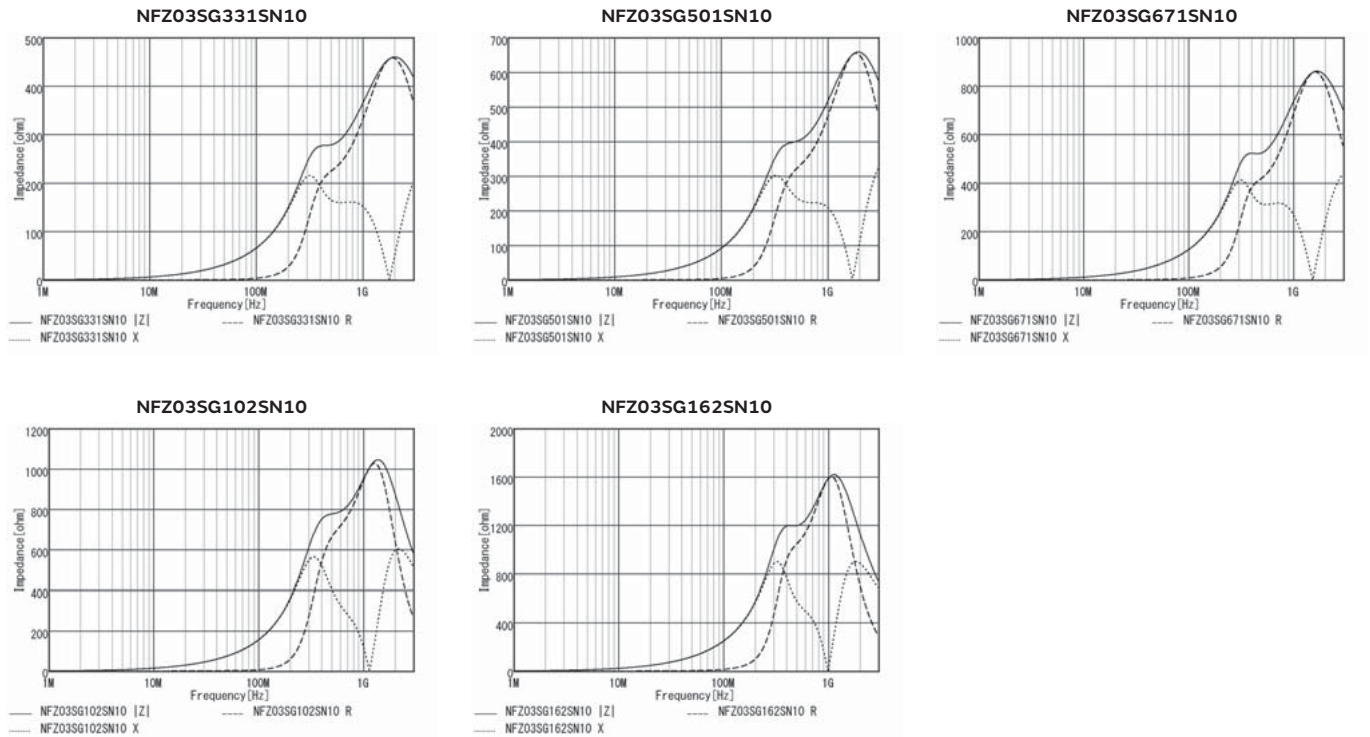

Application specified noise filter

NFZ15SG Series 0402/1005(inch/mm)

Noise filter for audio lines

Appearance/Dimensions

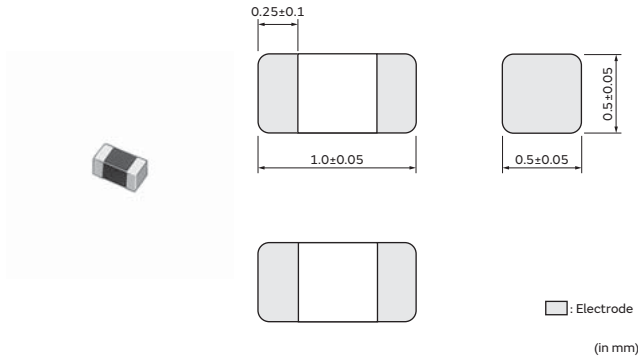

Packaging

| Code | Packaging | Minimum Quantity |
|------|-------------------|------------------|
| D | ø180mm Paper Tape | 10000 |
| B | Bulk(Bag) | 1000 |

Equivalent Circuit

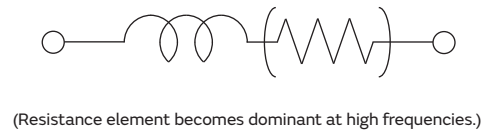

Rated Value (□: packaging code)

| Part Number | Impedance at 900MHz | Impedance at 1.7GHz | Rated Current | DC Resistance | DC Resistance (Max.) |
|-----------------|---------------------|---------------------|---------------|---------------|----------------------|
| NFZ15SG771SN10□ | 770Ω(Typ.) | 900Ω(Typ.) | 500mA | 0.35Ω (Typ.) | 0.5Ω |
| NFZ15SG152SN10□ | 1500Ω(Typ.) | 1200Ω(Typ.) | 400mA | 0.55Ω (Typ.) | 0.8Ω |
| NFZ15SG262SN10□ | 2600Ω(Typ.) | 1450Ω(Typ.) | 350mA | 0.80Ω (Typ.) | 1Ω |
| NFZ15SG462SN10□ | 4600Ω(Typ.) | 1800Ω(Typ.) | 270mA | 1.25Ω (Typ.) | 1.65Ω |
| NFZ15SG101SN11□ | 100Ω(Typ.) | 160Ω(Typ.) | 1.1A | 0.07Ω (Typ.) | 0.1Ω |
| NFZ15SG151SN11□ | 150Ω(Typ.) | 250Ω(Typ.) | 1A | 0.09Ω (Typ.) | 0.12Ω |
| NFZ15SG331SN11□ | 330Ω(Typ.) | 540Ω(Typ.) | 650mA | 0.20Ω (Typ.) | 0.3Ω |

Operating Temp. Range: -40°C to 85°C

Z-f characteristics

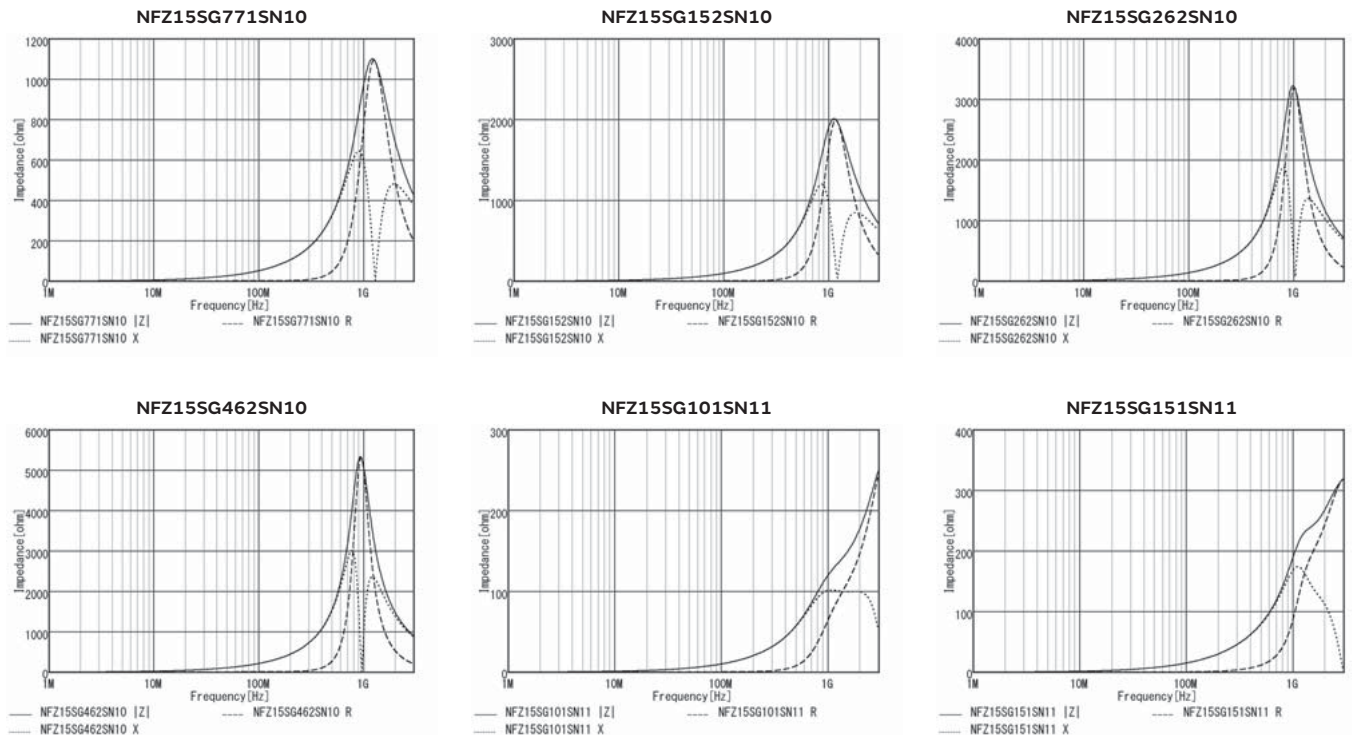

Continued on the following page. ↗

Continued from the preceding page. ↘

Z-f characteristics

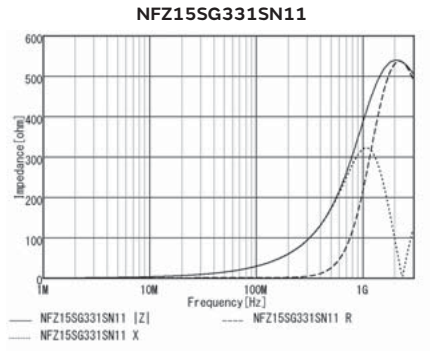

Application specified noise filter

NFZ18SM Series 0603/1608(inch/mm)

Noise filter for audio lines

Appearance/Dimensions

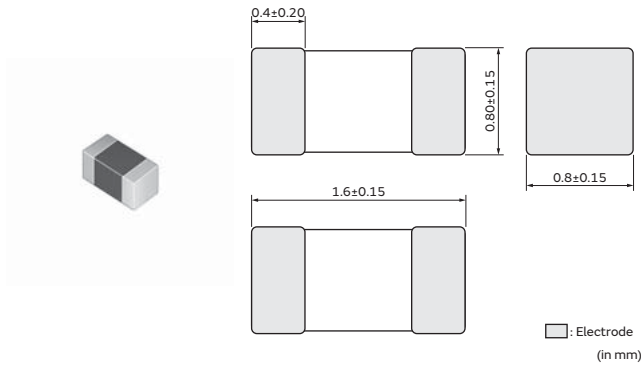

Packaging

| Code | Packaging | Minimum Quantity |
|------|-------------------|------------------|
| D | ø180mm Paper Tape | 4000 |
| B | Bulk(Bag) | 1000 |

Equivalent Circuit

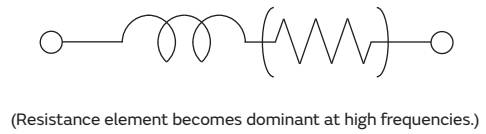

Rated Value (□: packaging code)

| Part Number | Impedance at 100MHz | Rated Current | DC Resistance | DC Resistance (Max.) |
|-----------------|---------------------|---------------|---------------|----------------------|
| NFZ18SM121SN10□ | 120Ω±25% | 1.25A | 0.11Ω (Typ.) | 0.14Ω |
| NFZ18SM251SN10□ | 250Ω±25% | 1.1A | 0.15Ω (Typ.) | 0.19Ω |
| NFZ18SM501SN10□ | 500Ω±25% | 950mA | 0.20Ω (Typ.) | 0.25Ω |
| NFZ18SM701SN10□ | 700Ω±25% | 800mA | 0.23Ω (Typ.) | 0.29Ω |

Operating Temp. Range: -55°C to 125°C

Z-f characteristics

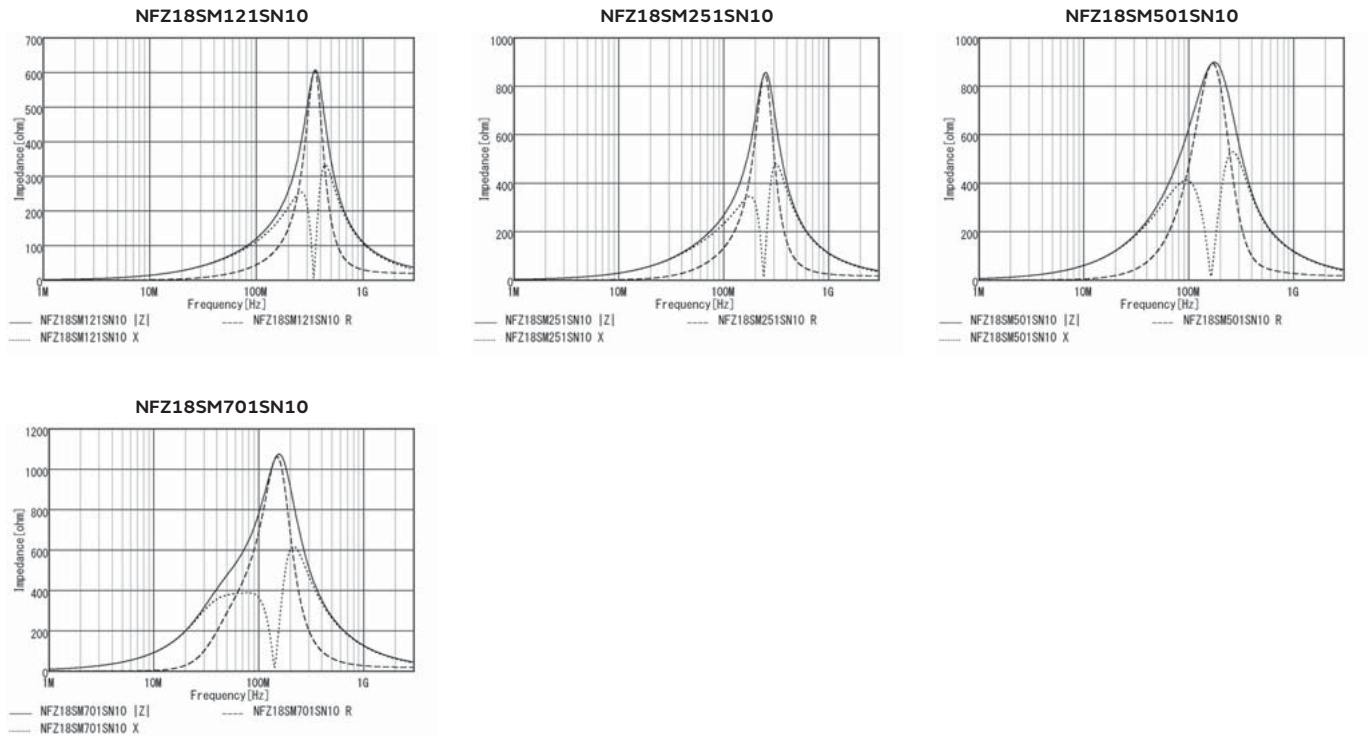

Continued on the following page. ↗

Continued from the preceding page. ↘

Derating of Rated Current

In operating temperature exceeding +85°C, derating of current is necessary for NFZ18SM series.
Please apply the derating curve shown in chart according to the operating temperature.

Derating of Rated Current

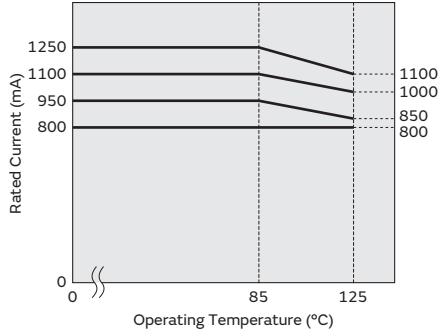

Chip Ferrite Bead

Application Specified Noise Filter

Chip EMIFIL®

Common Mode Choke Coil
Common Mode Noise Filter

Block Type EMIFIL®

EMC Absorber

Application specified noise filter

NFZ2MSM Series 0806/2016(inch/mm)

Noise filter for audio lines

Appearance/Dimensions

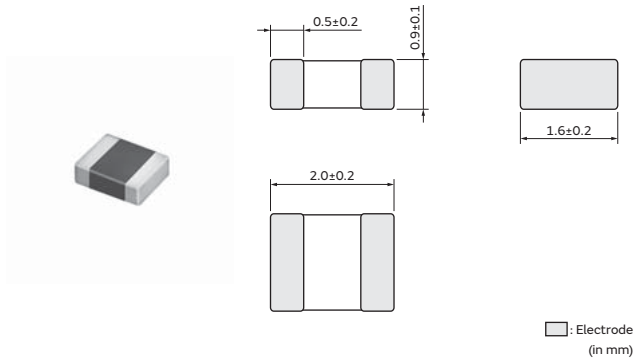

Packaging

| Code | Packaging | Minimum Quantity |
|------|----------------------|------------------|
| L | ø180mm Embossed Tape | 3000 |
| B | Bulk(Bag) | 1000 |

Equivalent Circuit



(Resistance element becomes dominant at high frequencies.)

Rated Value (□: packaging code)

| Part Number | Impedance at 100MHz | Rated Current | DC Resistance | DC Resistance (Max.) |
|-----------------|---------------------|---------------|---------------|----------------------|
| NFZ2MSM101SN10□ | 100Ω±25% | 4A | 0.014Ω (Typ.) | 0.018Ω |
| NFZ2MSM181SN10□ | 180Ω±25% | 3.4A | 0.020Ω (Typ.) | 0.025Ω |
| NFZ2MSM301SN10□ | 300Ω±25% | 3.1A | 0.024Ω (Typ.) | 0.03Ω |
| NFZ2MSM601SN10□ | 600Ω±25% | 2.5A | 0.037Ω (Typ.) | 0.046Ω |

Operating Temp. Range: -40°C to 85°C

Z-f characteristics

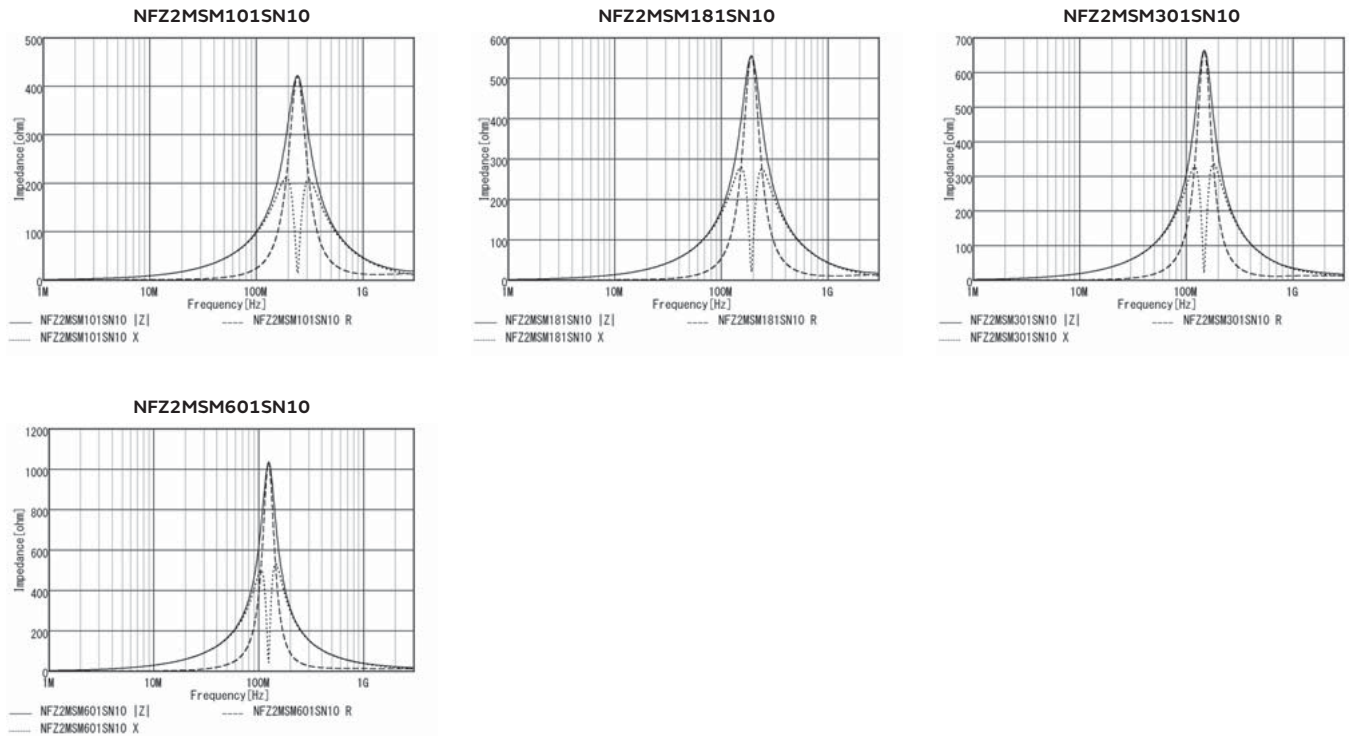

Application specified noise filter

NFZ32SW Series 1210/3225(inch/mm)

Noise filter for audio lines

Appearance/Dimensions

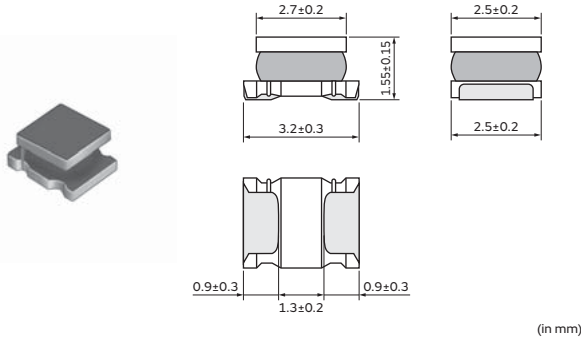

Packaging

| Code | Packaging | Minimum Quantity |
|------|----------------------|------------------|
| K | ø330mm Embossed Tape | 7500 |
| L | ø180mm Embossed Tape | 2000 |

Equivalent Circuit



(Resistance element becomes dominant at high frequencies.)

Rated Value (□: packaging code)

| Part Number | Impedance at 1MHz | Impedance at 100MHz | Rated Current | DC Resistance |
|-----------------|-------------------|---------------------|---------------|---------------|
| NFZ32SW301HN10□ | 3.2Ω±30% | 300Ω(Typ.) | 2.55A | 0.030Ω±20% |
| NFZ32SW901HN10□ | 6.8Ω±30% | 900Ω(Typ.) | 2.05A | 0.045Ω±20% |

Operating Temp. Range: -40°C to 85°C

Operating Temp. Range self-temp. rise included: -40°C to 125°C

Z-f characteristics

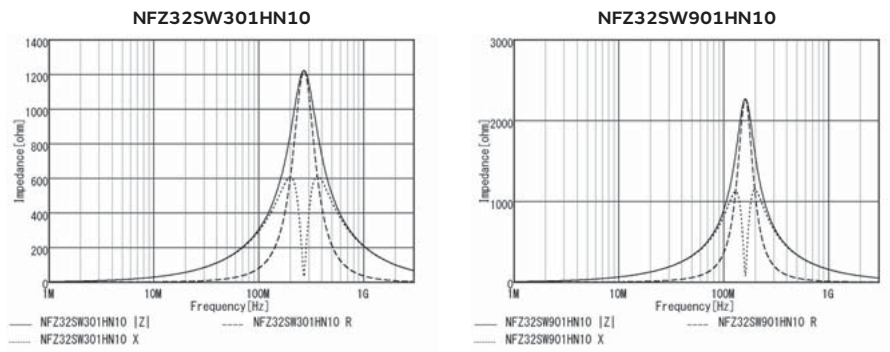

Application specified noise filter

NFZ2HBM Series 1008/2520(inch/mm)

Noise filter for LED lighting equipments

Appearance/Dimensions

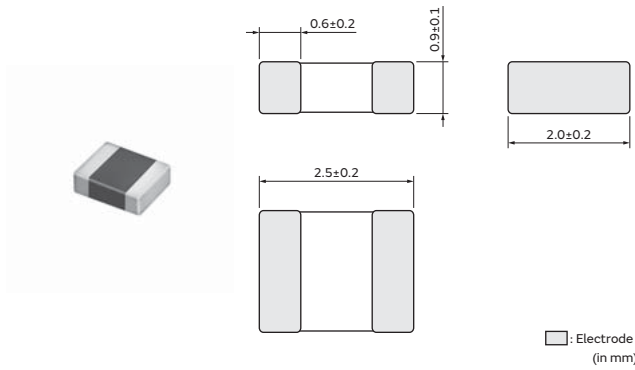

Packaging

| Code | Packaging | Minimum Quantity |
|------|----------------------|------------------|
| L | ø180mm Embossed Tape | 3000 |
| B | Bulk(Bag) | 1000 |

Equivalent Circuit



(Resistance element becomes dominant at high frequencies.)

Rated Value (□: packaging code)

| Part Number | Impedance at 1MHz | Rated Current | DC Resistance |
|-----------------|-------------------|---------------|---------------|
| NFZ2HBM1R5SN10□ | 1.5Ω±30% | 1.2A | 0.060Ω±25% |
| NFZ2HBM2R9SN10□ | 2.9Ω±30% | 1.1A | 0.085Ω±25% |
| NFZ2HBM4R4SN10□ | 4.4Ω±30% | 1.05A | 0.105Ω±25% |
| NFZ2HBM6R1SN10□ | 6.1Ω±30% | 1A | 0.125Ω±25% |
| NFZ2HBM8R4SN10□ | 8.4Ω±30% | 900mA | 0.145Ω±25% |
| NFZ2HBM110SN10□ | 11Ω±30% | 800mA | 0.160Ω±25% |
| NFZ2HBM170SN10□ | 17Ω±30% | 700mA | 0.210Ω±25% |
| NFZ2HBM240SN10□ | 24Ω±30% | 650mA | 0.250Ω±25% |
| NFZ2HBM330SN10□ | 33Ω±30% | 500mA | 0.300Ω±25% |
| NFZ2HBM600SN10□ | 60Ω±30% | 400mA | 0.300Ω±25% |

Operating Temp. Range: -55°C to 125°C

Z-f characteristics

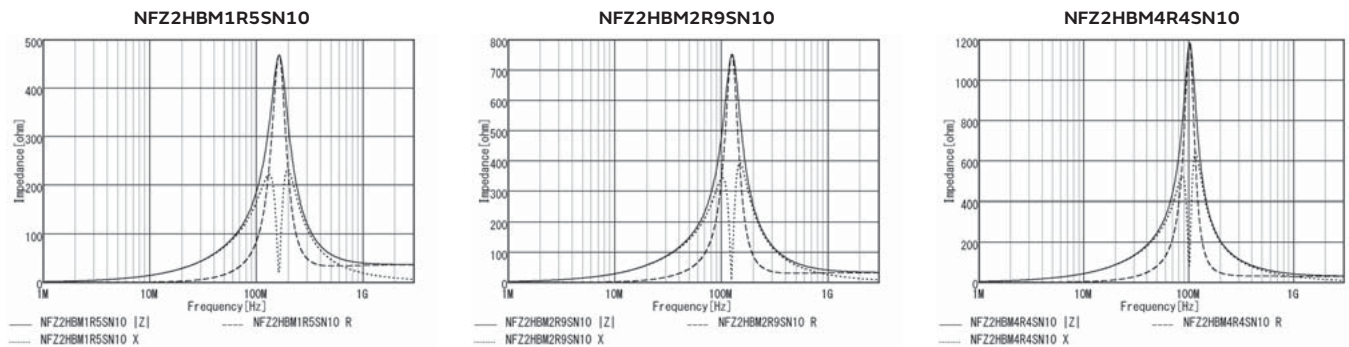

Continued on the following page. ↗

Continued from the preceding page. ↘

Z-f characteristics

NFZ2HBM6R1SN10

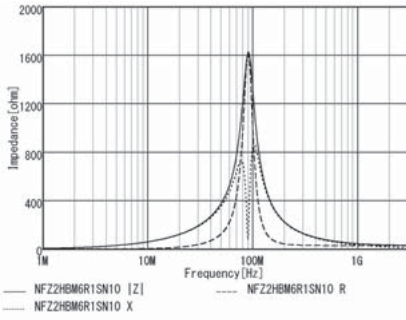

NFZ2HBM8R4SN10

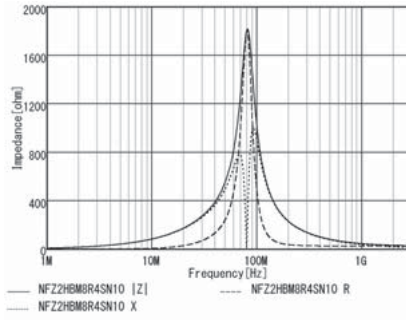

NFZ2HBM110SN10

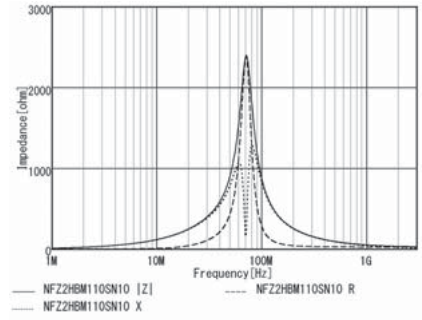

NFZ2HBM170SN10

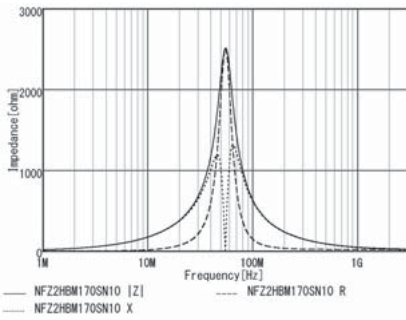

NFZ2HBM240SN10

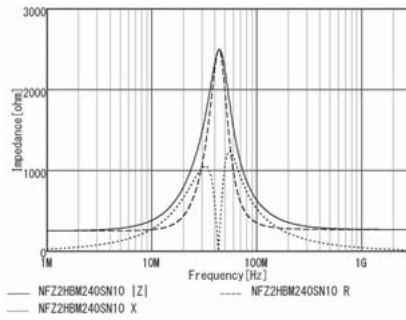

NFZ2HBM330SN10

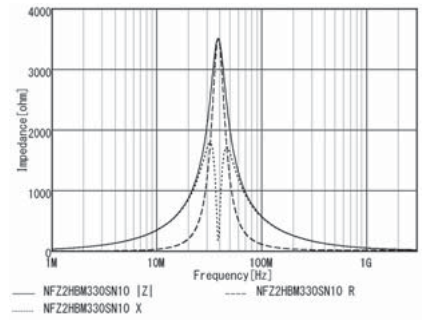

NFZ2HBM600SN10

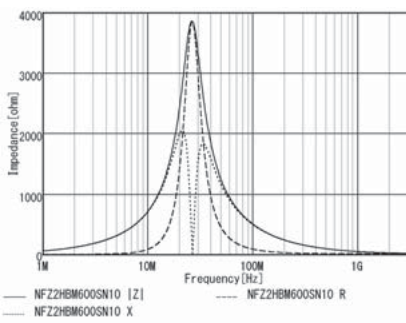

Application specified noise filter

NFZ32BW Series 1210/3225(inch/mm)

Noise filter for LED lighting equipments

Appearance/Dimensions

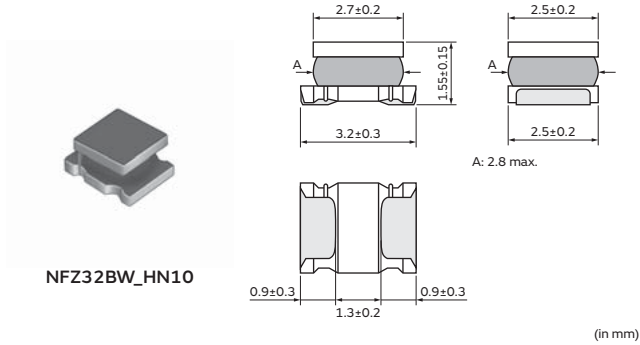

Packaging

| Code | Packaging | Minimum Quantity |
|------|----------------------|------------------|
| K | ø330mm Embossed Tape | 7500 |
| L | ø180mm Embossed Tape | 2000 |

Equivalent Circuit



(Resistance element becomes dominant at high frequencies.)

Appearance/Dimensions

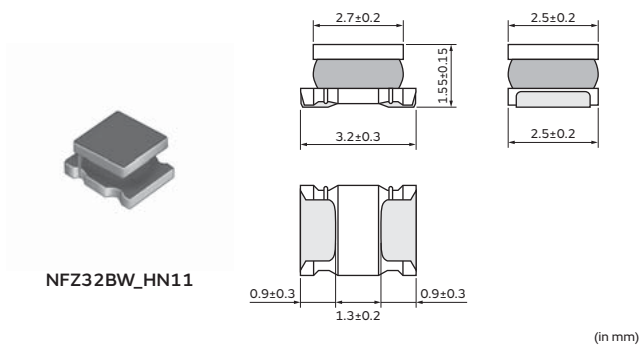

Packaging

| Code | Packaging | Minimum Quantity |
|------|----------------------|------------------|
| K | ø330mm Embossed Tape | 7500 |
| L | ø180mm Embossed Tape | 2000 |

Equivalent Circuit



(Resistance element becomes dominant at high frequencies.)

Rated Value (□: packaging code)

| Part Number | Impedance at 1MHz | Rated Current | DC Resistance |
|-----------------|-------------------|---------------|---------------|
| NFZ32BW3R6HN10□ | 3.6Ω±30% | 2.55A | 0.03Ω±20% |
| NFZ32BW7R4HN10□ | 7.4Ω±30% | 2.05A | 0.045Ω±20% |
| NFZ32BW9R0HN10□ | 9Ω±30% | 1.75A | 0.057Ω±20% |
| NFZ32BW150HN10□ | 15Ω±30% | 1.6A | 0.076Ω±20% |
| NFZ32BW210HN10□ | 21Ω±30% | 1.2A | 0.12Ω±20% |
| NFZ32BW320HN10□ | 32Ω±30% | 1A | 0.18Ω±20% |
| NFZ32BW420HN10□ | 42Ω±30% | 850mA | 0.24Ω±20% |
| NFZ32BW700HN10□ | 70Ω±30% | 700mA | 0.38Ω±20% |
| NFZ32BW111HN10□ | 110Ω±30% | 520mA | 0.57Ω±20% |
| NFZ32BW151HN10□ | 150Ω±30% | 450mA | 0.81Ω±20% |
| NFZ32BW221HN10□ | 220Ω±30% | 390mA | 1.15Ω±20% |
| NFZ32BW291HN10□ | 290Ω±30% | 310mA | 1.78Ω±20% |
| NFZ32BW451HN10□ | 450Ω±30% | 275mA | 2.28Ω±20% |
| NFZ32BW621HN10□ | 620Ω±30% | 250mA | 2.7Ω±20% |
| NFZ32BW881HN10□ | 880Ω±30% | 200mA | 4.38Ω±20% |
| NFZ32BW3R3HN11□ | 3.3Ω±30% | 2.9A | 0.024Ω±20% |
| NFZ32BW6R8HN11□ | 6.8Ω±30% | 2.5A | 0.036Ω±20% |
| NFZ32BW8R4HN11□ | 8.4Ω±30% | 2.4A | 0.048Ω±20% |
| NFZ32BW9R8HN11□ | 9.8Ω±30% | 2.1A | 0.053Ω±20% |

Operating Temp. Range: -40°C to 105°C

Operating Temp. Range self-temp. rise included: -40°C to 125°C

Continued from the preceding page. ↘

| Part Number | Impedance at 1MHz | Rated Current | DC Resistance |
|-----------------|-------------------|---------------|---------------|
| NFZ32BW120HN11□ | 12Ω±30% | 1.85A | 0.064Ω±20% |
| NFZ32BW190HN11□ | 19Ω±30% | 1.8A | 0.089Ω±20% |
| NFZ32BW210HN11□ | 21Ω±30% | 1.55A | 0.100Ω±20% |
| NFZ32BW310HN11□ | 31Ω±30% | 1.2A | 0.155Ω±20% |
| NFZ32BW520HN11□ | 52Ω±30% | 1.1A | 0.220Ω±20% |
| NFZ32BW650HN11□ | 65Ω±30% | 900mA | 0.295Ω±20% |
| NFZ32BW101HN11□ | 100Ω±30% | 900mA | 0.475Ω±20% |
| NFZ32BW151HN11□ | 150Ω±30% | 700mA | 0.685Ω±20% |

Operating Temp. Range: -40°C to 105°C

Operating Temp. Range self-temp. rise included: -40°C to 125°C

Z-f characteristics

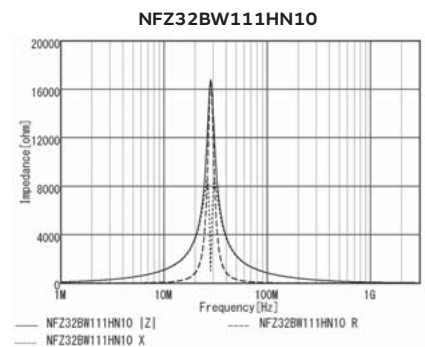
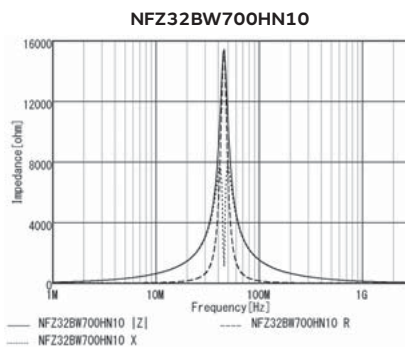
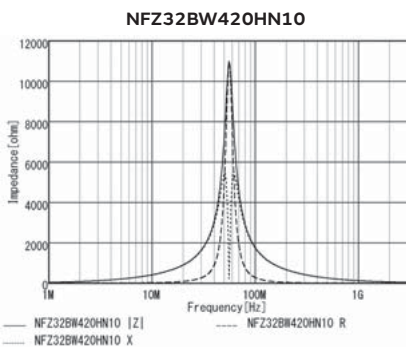
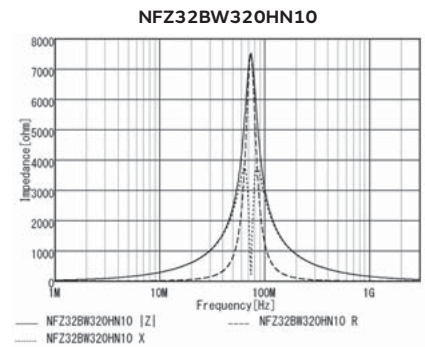
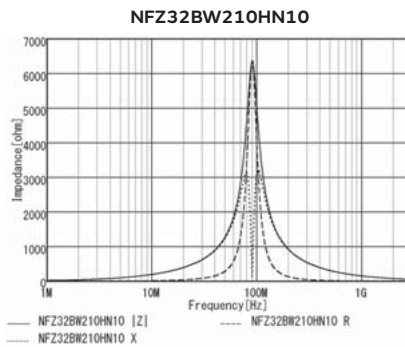
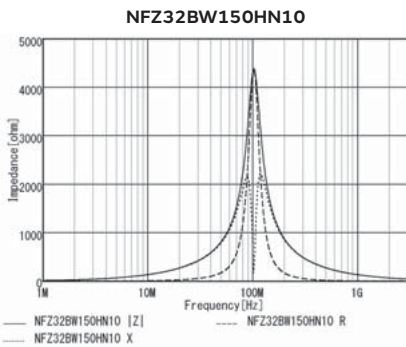
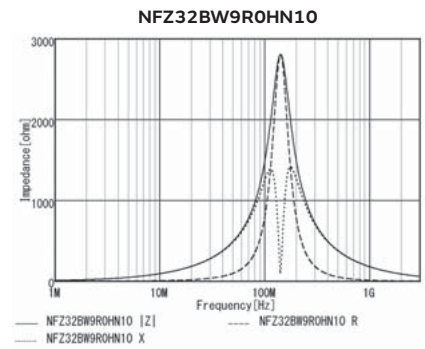
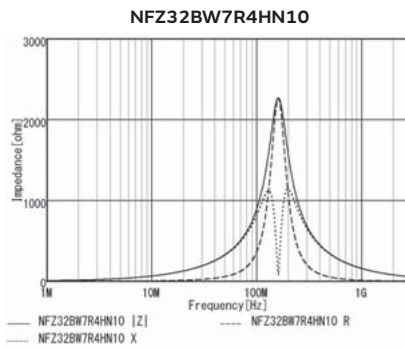
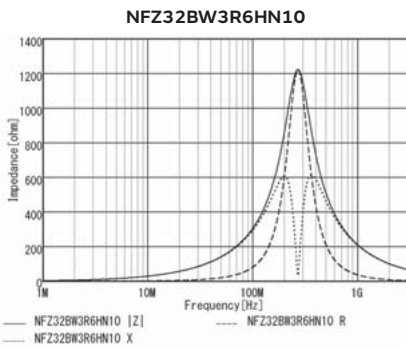

Continued on the following page. ↗

Continued from the preceding page. ↘

Z-f characteristics

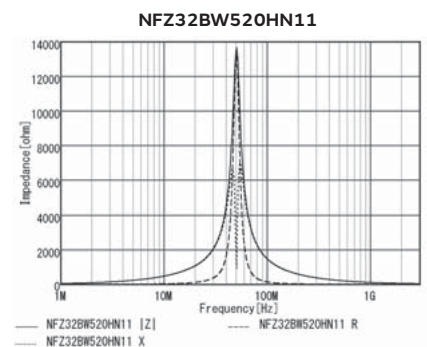
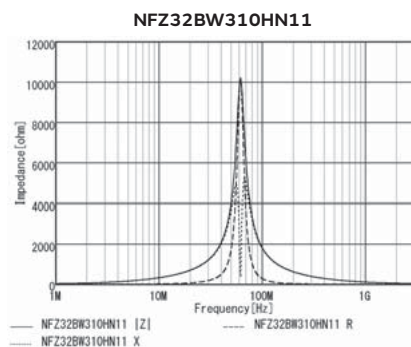
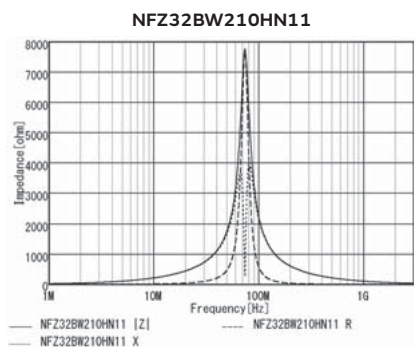
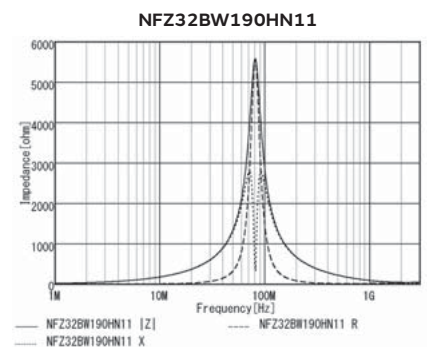
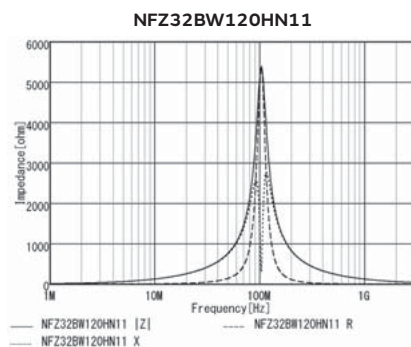
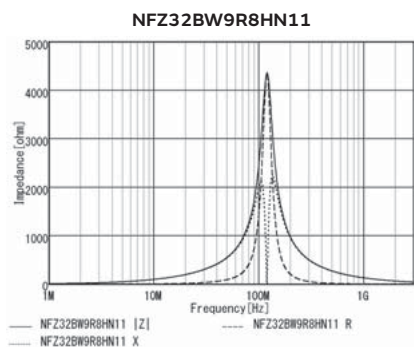
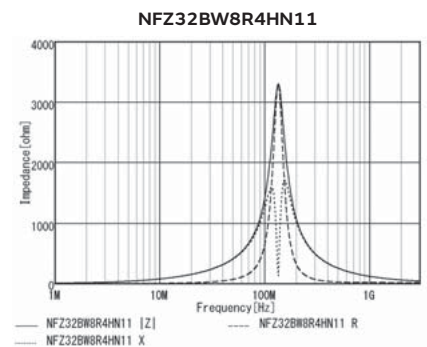
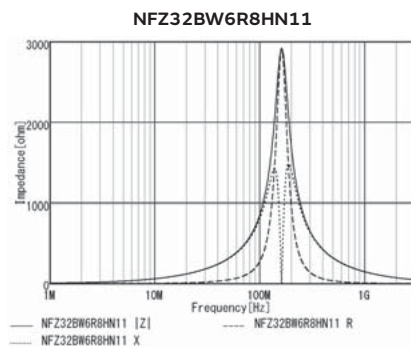
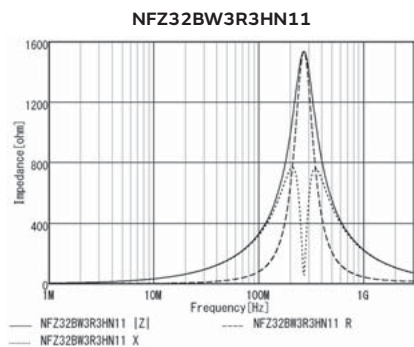
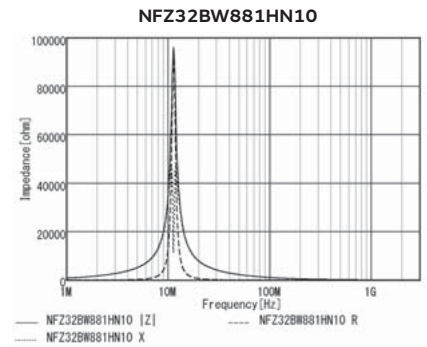
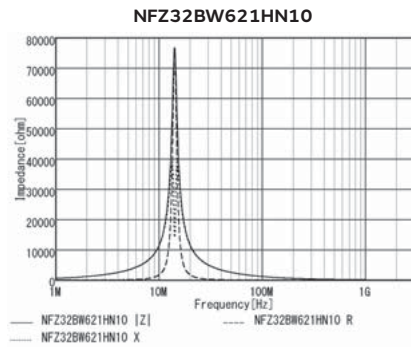
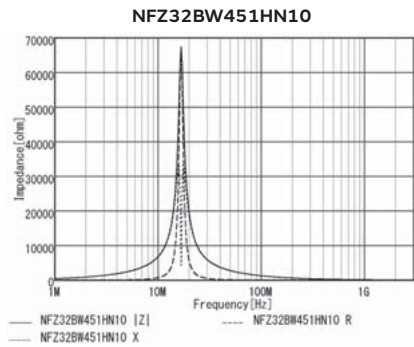
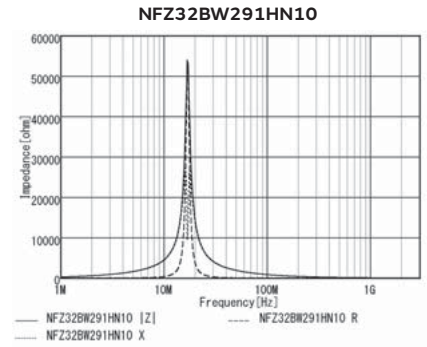
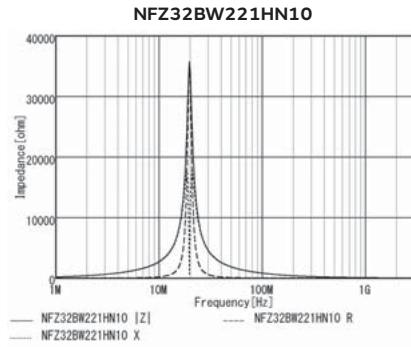
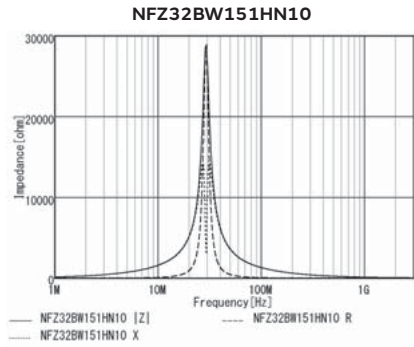

Continued from the preceding page. ↘

Z-f characteristics

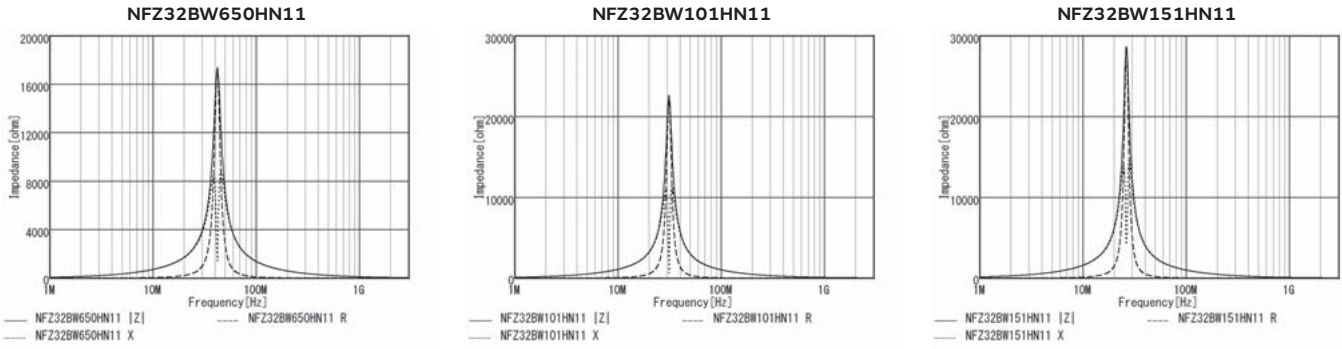

Derating of Rated Current

In operating temperature exceeding +85°C, derating of current is necessary for NFZ32BW_H□10 series. Please apply the derating curve shown in chart according to the operating temperature.

In operating temperature exceeding +85°C, derating of current is necessary for NFZ32BW_H□11 series. Please apply the derating curve shown in chart according to the operating temperature.

Derating of Rated Current

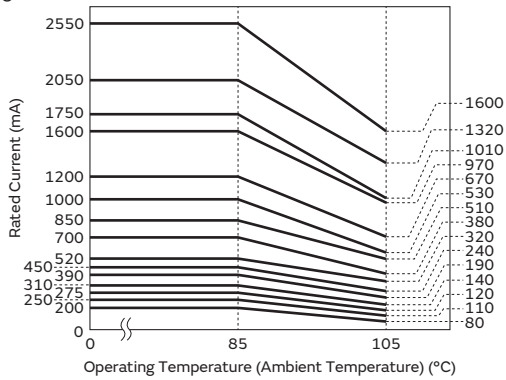

Derating of Rated Current

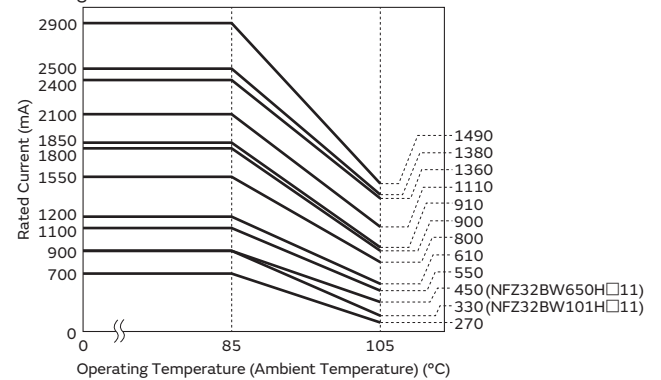

Application specified noise filter

NFZ5BBW Series 2020/5050(inch/mm)

Noise filter for LED lighting equipments

Appearance/Dimensions

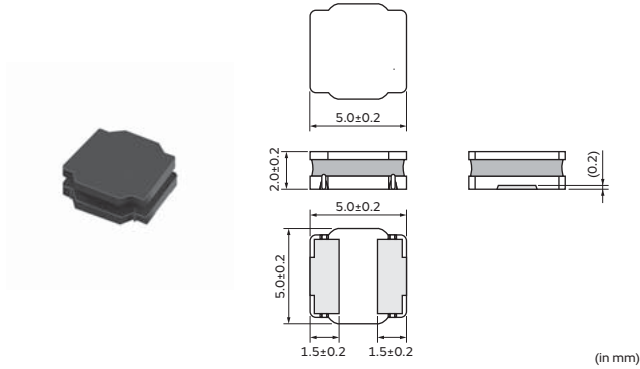

Packaging

| Code | Packaging | Minimum Quantity |
|------|----------------------|------------------|
| K | ø330mm Embossed Tape | 3000 |
| L | ø180mm Embossed Tape | 500 |

Equivalent Circuit

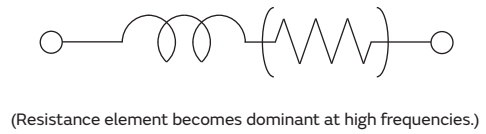

Rated Value (□: packaging code)

| Part Number | Impedance at 1MHz | Rated Current | DC Resistance |
|-----------------|-------------------|---------------|---------------|
| NFZ5BBW2R9LN10□ | 2.9Ω±30% | 4A | 0.012Ω±20% |
| NFZ5BBW4R5LN10□ | 4.5Ω±30% | 3.4A | 0.015Ω±20% |
| NFZ5BBW6R7LN10□ | 6.7Ω±30% | 3.1A | 0.019Ω±20% |
| NFZ5BBW7R6LN10□ | 7.6Ω±30% | 3.1A | 0.019Ω±20% |
| NFZ5BBW100LN10□ | 10Ω±30% | 3A | 0.024Ω±20% |
| NFZ5BBW140LN10□ | 14Ω±30% | 2.6A | 0.030Ω±20% |
| NFZ5BBW170LN10□ | 17Ω±30% | 2.5A | 0.035Ω±20% |
| NFZ5BBW220LN10□ | 22Ω±30% | 2.3A | 0.044Ω±20% |
| NFZ5BBW310LN10□ | 31Ω±30% | 2A | 0.058Ω±20% |
| NFZ5BBW450LN10□ | 45Ω±30% | 1.65A | 0.083Ω±20% |
| NFZ5BBW520LN10□ | 52Ω±30% | 1.61A | 0.100Ω±20% |
| NFZ5BBW610LN10□ | 61Ω±30% | 1.6A | 0.106Ω±20% |
| NFZ5BBW970LN10□ | 97Ω±30% | 1.2A | 0.187Ω±20% |
| NFZ5BBW141LN10□ | 140Ω±30% | 1.05A | 0.259Ω±20% |

Operating Temp. Range: -40°C to 105°C

Operating Temp. Range self-temp. rise included: -40°C to 125°C

Z-f characteristics

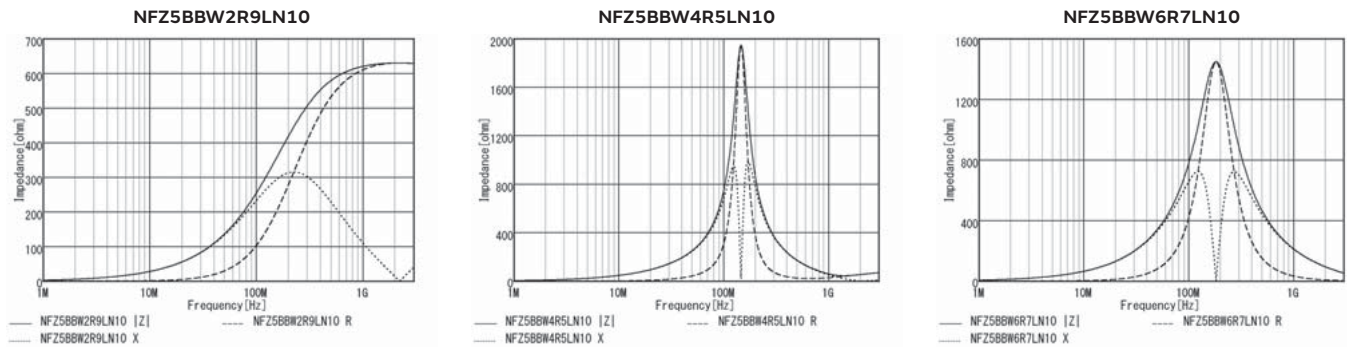

Continued on the following page. ↗

Continued from the preceding page. ↘

Z-f characteristics

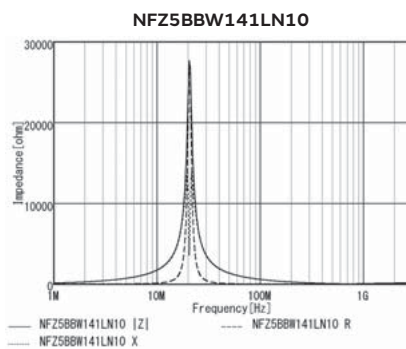
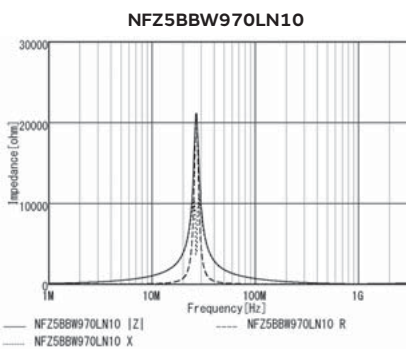
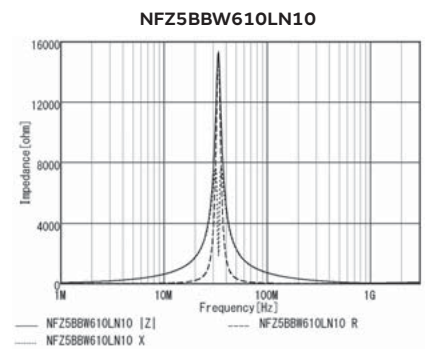
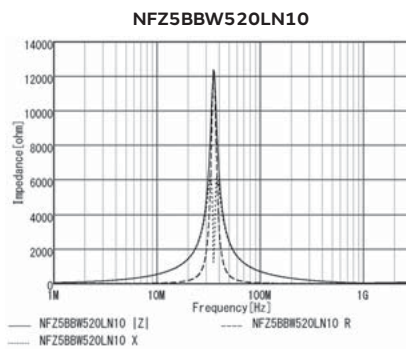
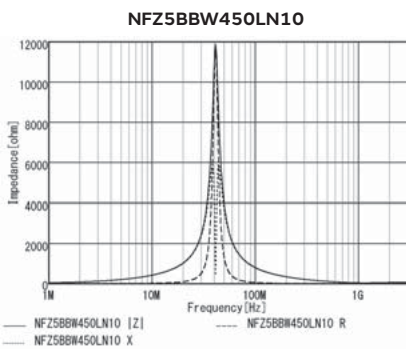
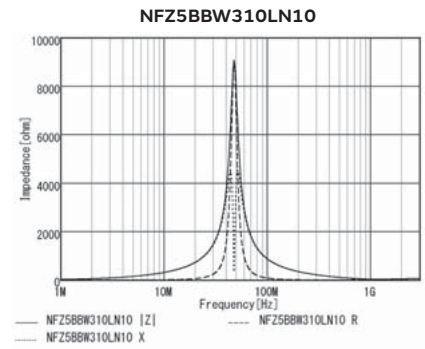
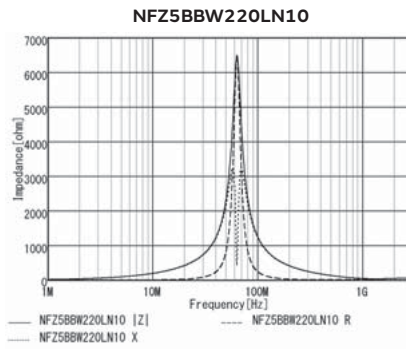
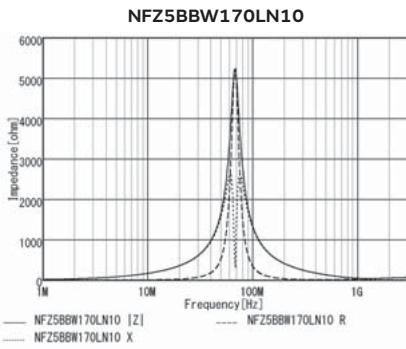
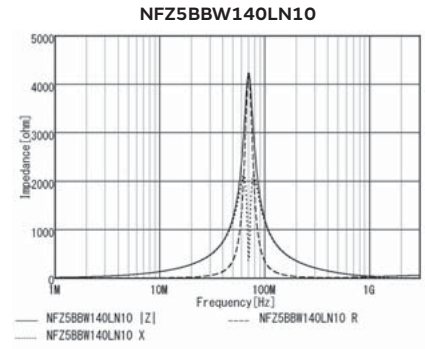
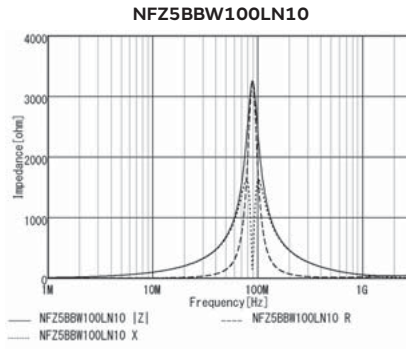
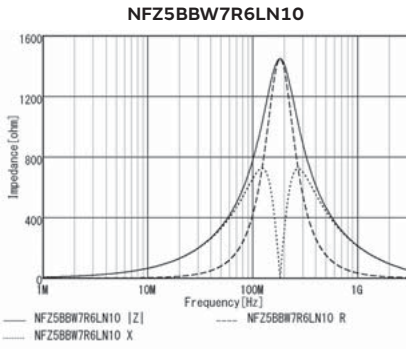

Continued on the following page. ↗

Continued from the preceding page. ↘

Derating of Rated Current

In operating temperature exceeding +85°C, derating of current is necessary for NFZ5BBW_L□10 series.
 Please apply the derating curve shown in chart according to the operating temperature.

Derating of Rated Current

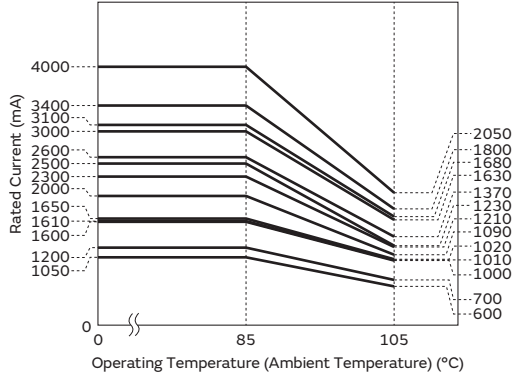

Application specified noise filter

BLF02JD Series 01005/0402(inch/mm)

Frequency specified noise filter

Appearance/Dimensions

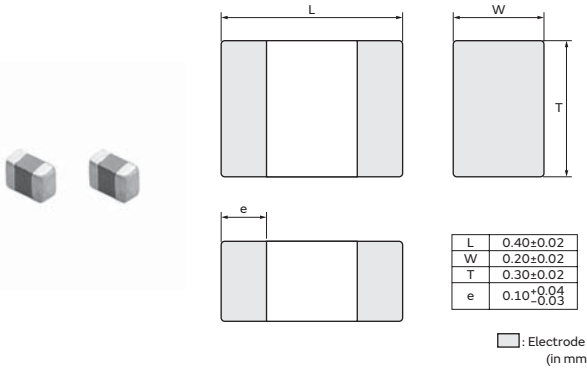

Packaging

| Code | Packaging | Minimum Quantity |
|------|-------------------|------------------|
| D | ø180mm Paper Tape | 15000 |
| B | Bulk(Bag) | 1000 |

Equivalent Circuit



(Resistance element becomes dominant at high frequencies.)

Rated Value (□: packaging code)

| Part Number | Impedance at Target Frequency | Rated Current at 85°C | Rated Current at 125°C | DC Resistance |
|----------------|-------------------------------|-----------------------|------------------------|---------------|
| BLF02JD361GNE□ | 360Ω±40% (at 700MHz) | 380mA | 250mA | 0.45Ω |
| BLF02JD471GNE□ | 470Ω±40% (at 700MHz) | 330mA | 220mA | 0.6Ω |

Operating Temp. Range: -55°C to 125°C

Z-f characteristics

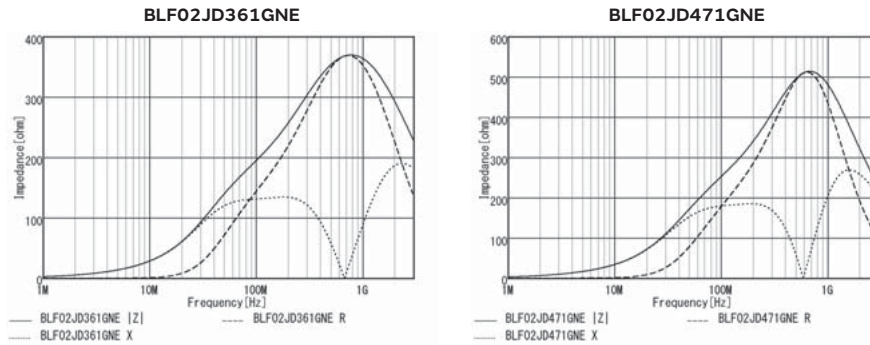

Derating of Rated Current

In operating temperature exceeding +85°C, derating of current is necessary for this series.
 Please apply the derating curve shown in chart according to the operating temperature.

Derating of Rated Current

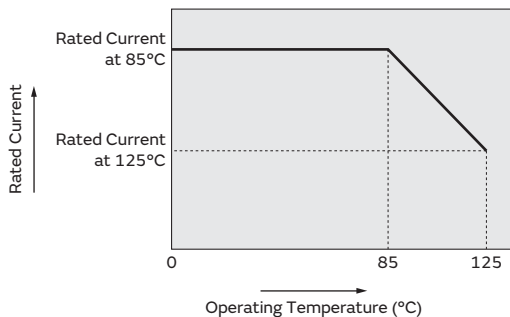

Application specified noise filter

BLF02RD Series 01005/0402(inch/mm)

Frequency specified noise filter

Appearance/Dimensions

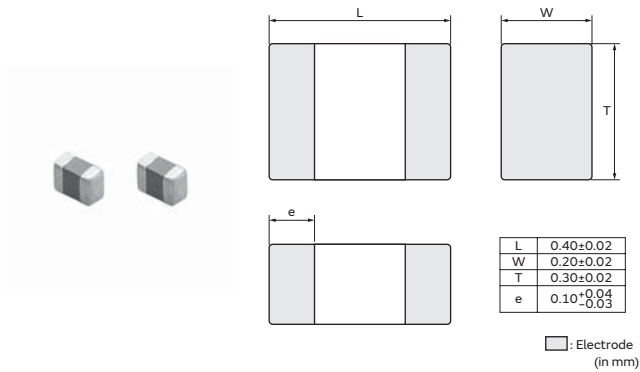

Packaging

| Code | Packaging | Minimum Quantity |
|------|-------------------|------------------|
| D | ø180mm Paper Tape | 15000 |
| B | Bulk(Bag) | 1000 |

Equivalent Circuit

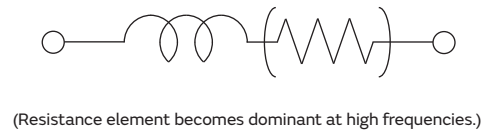

Rated Value (□: packaging code)

| Part Number | Impedance at Target Frequency | Rated Current at 85°C | Rated Current at 125°C | DC Resistance |
|----------------|-------------------------------|-----------------------|------------------------|---------------|
| BLF02RD331GNE□ | 330Ω±40% (at 2.4GHz) | 330mA | 220mA | 0.6Ω |
| BLF02RD471GNE□ | 470Ω±40% (at 2.4GHz) | 200mA | 130mA | 0.9Ω |

Operating Temp. Range: -55°C to 125°C

Z-f characteristics

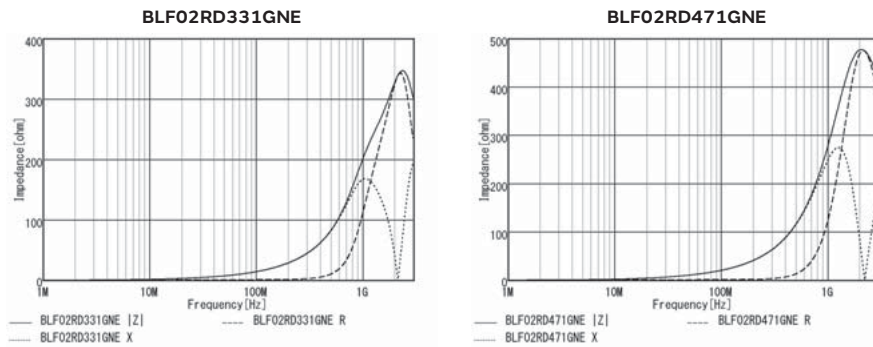

Derating of Rated Current

In operating temperature exceeding +85°C, derating of current is necessary for this series.
 Please apply the derating curve shown in chart according to the operating temperature.

Derating of Rated Current

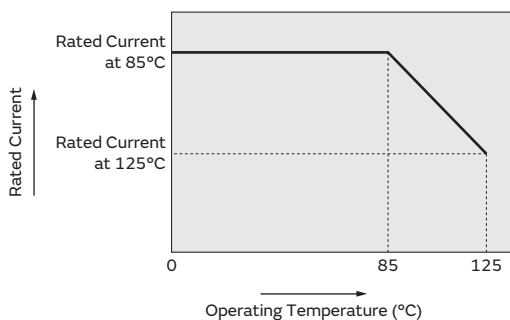

Application specified noise filter

BLF03JD Series 0201/0603(inch/mm)

Frequency specified noise filter

Appearance/Dimensions

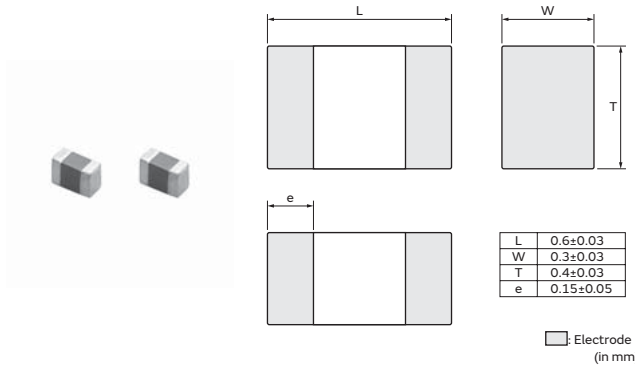

Packaging

| Code | Packaging | Minimum Quantity |
|------|-------------------|------------------|
| D | ø180mm Paper Tape | 15000 |
| B | Bulk(Bag) | 1000 |

Equivalent Circuit



(Resistance element becomes dominant at high frequencies.)

Rated Value (□: packaging code)

| Part Number | Impedance at Target Frequency | Rated Current at 85°C | Rated Current at 125°C | DC Resistance | Operating Temp. Range |
|----------------|-------------------------------|-----------------------|------------------------|---------------|-----------------------|
| BLF03JD421GNE□ | 420Ω±40% (at 700MHz) | 480mA | 370mA | 0.28Ω | -55°C to 125°C |

Z-f characteristics

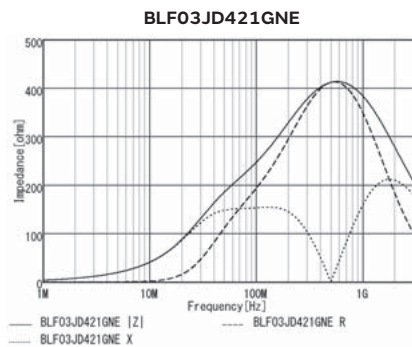

Derating of Rated Current

In operating temperature exceeding +85°C, derating of current is necessary for this series.
 Please apply the derating curve shown in chart according to the operating temperature.

Derating of Rated Current

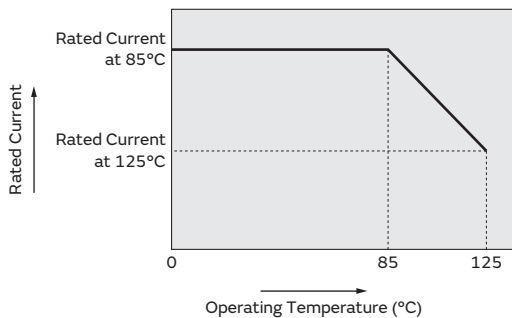

Application specified noise filter

BLE18PS Series 0603/1608(inch/mm)

Noise filter for power charger lines

Appearance/Dimensions

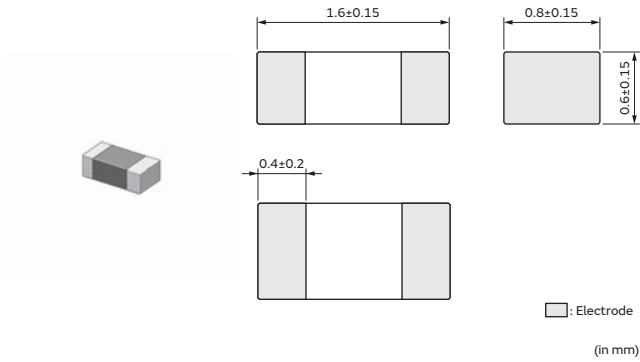

Packaging

| Code | Packaging | Minimum Quantity |
|------|-------------------|------------------|
| D | ø180mm Paper Tape | 4000 |
| J | ø330mm Paper Tape | 10000 |
| B | Bulk(Bag) | 1000 |

Equivalent Circuit

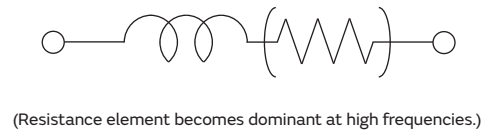

Rated Value (□: packaging code)

| Part Number | Impedance at 100MHz | Rated Current at 85°C | Rated Current at 125°C | DC Resistance | Operating Temp. Range |
|----------------|---------------------|-----------------------|------------------------|---------------|-----------------------|
| BLE18PS080SN1□ | 8.5Ω±25% | 8A | 5A | 0.004Ω | -55°C to 125°C |

Z-f characteristics

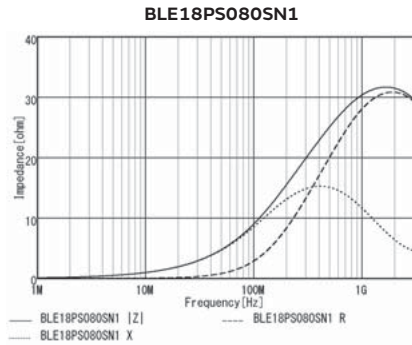

Derating of Rated Current

In operating temperature exceeding +85°C, derating of current is necessary for BLE18PS series.
 Please apply the derating curve shown in chart according to the operating temperature.

Derating of Rated Current

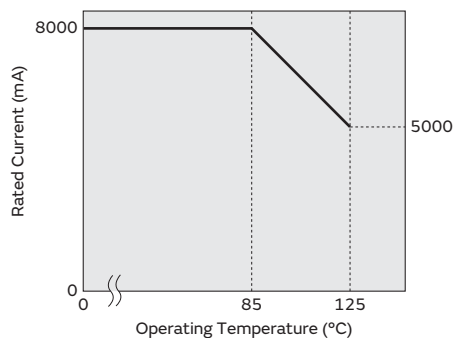

Application specified noise filter

BLE32PN Series 1210/3225(inch/mm)

Noise filter for power charger lines

Appearance/Dimensions

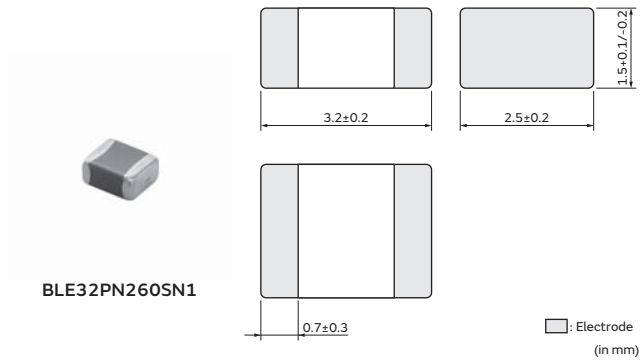

Packaging

| Code | Packaging | Minimum Quantity |
|------|----------------------|------------------|
| K | ø330mm Embossed Tape | 7000 |
| L | ø180mm Embossed Tape | 1500 |
| B | Bulk(Bag) | 1000 |

Equivalent Circuit

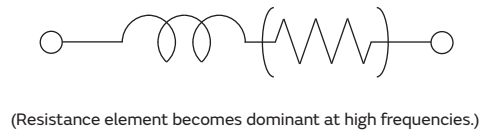

Appearance/Dimensions

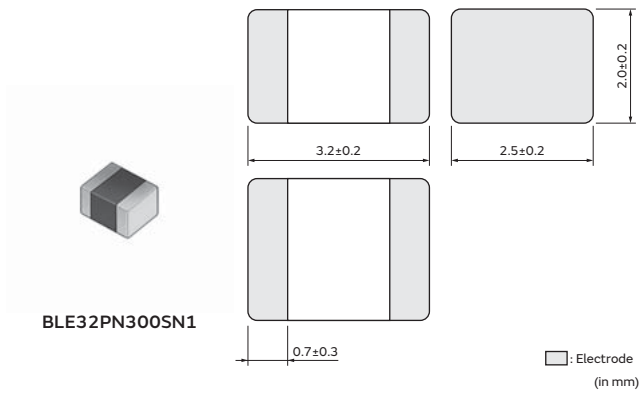

Packaging

| Code | Packaging | Minimum Quantity |
|------|----------------------|------------------|
| K | ø330mm Embossed Tape | 7000 |
| L | ø180mm Embossed Tape | 1500 |
| B | Bulk(Bag) | 1000 |

Equivalent Circuit

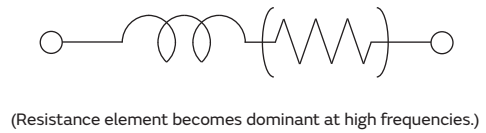

Rated Value (□: packaging code)

| Part Number | Impedance at 100MHz | Rated Current at 85°C | Rated Current at 125°C | DC Resistance |
|----------------|---------------------|-----------------------|------------------------|---------------|
| BLE32PN260SN1□ | 26Ω±10Ω | 10A | 10A | 1.6mΩ |
| BLE32PN300SN1□ | 30Ω±10Ω | 10A | 10A | 1.6mΩ |

Operating Temp. Range: -55°C to 125°C

Z-f characteristics

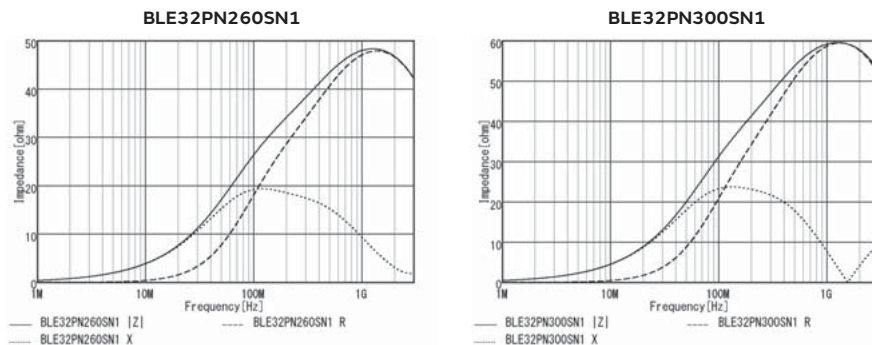

Application Specified Noise Filter

LQW04CA_00 Series 03019/0805(inch/mm)

Inductor for audio line noise suppression

Appearance/Dimensions

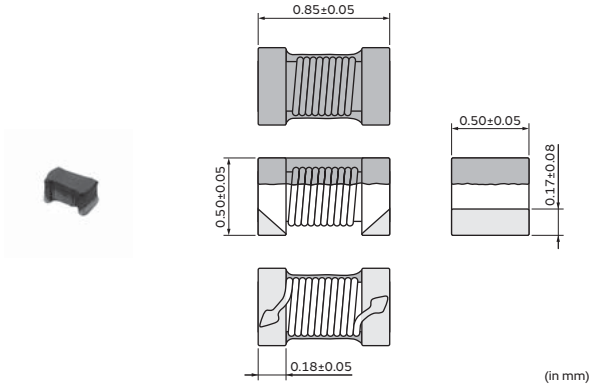

Packaging

| Code | Packaging | Minimum Quantity |
|------|---------------------|------------------|
| D | ø180mm Paper Taping | 10000 |
| B | Packing in Bulk | 500 |

Rated Value (□: packaging code)

| Part Number | Inductance | Inductance Test Frequency | Rated Current | Max. of DC Resistance | S.R.F.* (min.) |
|----------------|------------|---------------------------|---------------|-----------------------|----------------|
| LQW04CA60NK00□ | 60nH ±10% | 100MHz | 620mA | 0.18Ω | 3000MHz |
| LQW04CA90NK00□ | 90nH ±10% | 100MHz | 520mA | 0.24Ω | 2500MHz |
| LQW04CAR12K00□ | 120nH ±10% | 100MHz | 510mA | 0.28Ω | 2100MHz |
| LQW04CAR29K00□ | 290nH ±10% | 100MHz | 270mA | 0.94Ω | 1400MHz |
| LQW04CAR45K00□ | 450nH ±10% | 100MHz | 200mA | 1.23Ω | 850MHz |
| LQW04CAR51K00□ | 510nH ±10% | 100MHz | 200mA | 1.31Ω | 700MHz |

Operating temp. range (Self-temp. rise not included): -40 to 85°C
 Class of Magnetic Shield: No Shield
 For reflow soldering only
 *S.R.F.: Self-Resonant Frequency

Inductance-Frequency Characteristics (Typ.)

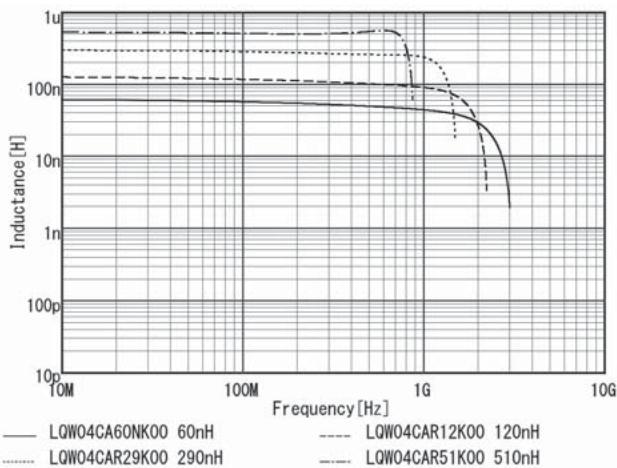

Impedance-Frequency Characteristics (Typ.)

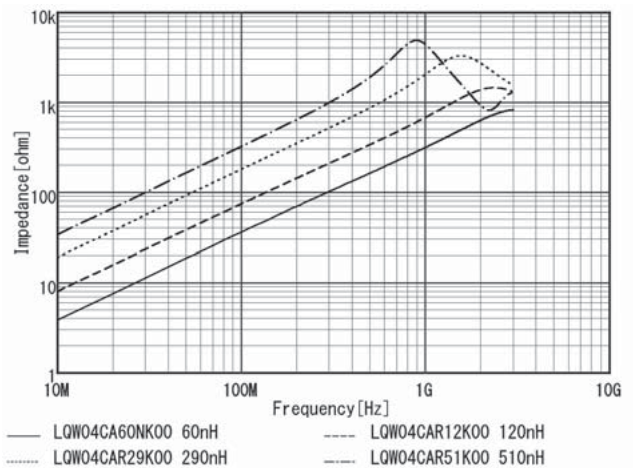

Application Specified Noise Filter

LQW15CA_00 Series 0402/1005(inch/mm)

Inductor for audio line noise suppression

Appearance/Dimensions

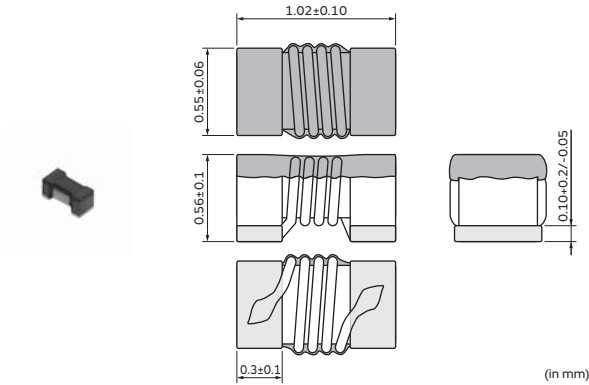

Packaging

| Code | Packaging | Minimum Quantity |
|------|---------------------|------------------|
| D | ø180mm Paper Taping | 10000 |
| B | Packing in Bulk | 500 |

Rated Value (□: packaging code)

| Part Number | Inductance | Inductance Test Frequency | Rated Current | Max. of DC Resistance | S.R.F.* (min.) | Remark |
|----------------|------------|---------------------------|---------------|-----------------------|----------------|--------|
| LQW15CA22NJ00□ | 22nH ±5% | 10MHz | 1300mA | 0.06Ω | 3000MHz | *1 |
| LQW15CA22NK00□ | 22nH ±10% | 10MHz | 1300mA | 0.06Ω | 3000MHz | *1 |
| LQW15CA39NJ00□ | 39nH ±5% | 10MHz | 1100mA | 0.075Ω | 2700MHz | *2 |
| LQW15CA39NK00□ | 39nH ±10% | 10MHz | 1100mA | 0.075Ω | 2700MHz | *2 |
| LQW15CA59NJ00□ | 59nH ±5% | 10MHz | 1000mA | 0.095Ω | 2300MHz | *3 |
| LQW15CA59NK00□ | 59nH ±10% | 10MHz | 1000mA | 0.095Ω | 2300MHz | *3 |
| LQW15CA83NJ00□ | 83nH ±5% | 10MHz | 970mA | 0.12Ω | 1700MHz | *4 |
| LQW15CA83NK00□ | 83nH ±10% | 10MHz | 970mA | 0.12Ω | 1700MHz | *4 |
| LQW15CAR11J00□ | 110nH ±5% | 10MHz | 900mA | 0.13Ω | 1600MHz | *5 |
| LQW15CAR11K00□ | 110nH ±10% | 10MHz | 900mA | 0.13Ω | 1600MHz | *5 |
| LQW15CAR14J00□ | 140nH ±5% | 10MHz | 680mA | 0.18Ω | 1400MHz | *6 |
| LQW15CAR14K00□ | 140nH ±10% | 10MHz | 680mA | 0.18Ω | 1400MHz | *6 |
| LQW15CAR18J00□ | 180nH ±5% | 10MHz | 640mA | 0.21Ω | 1300MHz | *7 |
| LQW15CAR18K00□ | 180nH ±10% | 10MHz | 640mA | 0.21Ω | 1300MHz | *7 |
| LQW15CAR22J00□ | 220nH ±5% | 10MHz | 540mA | 0.29Ω | 1300MHz | *8 |
| LQW15CAR22K00□ | 220nH ±10% | 10MHz | 540mA | 0.29Ω | 1300MHz | *8 |
| LQW15CAR27J00□ | 270nH ±5% | 10MHz | 480mA | 0.38Ω | 1200MHz | *9 |

Operating temp. range (Self-temp. rise included): -40 to 125°C

Class of Magnetic Shield: No Shield

For reflow soldering only

*S.R.F.: Self-Resonant Frequency

*1: Typical impedance: 100Ω (typ) @900MHz/150Ω (typ) @1.7GHz

*2: Typical impedance: 180Ω (typ) @900MHz/280Ω (typ) @1.7GHz

*3: Typical impedance: 290Ω (typ) @900MHz/360Ω (typ) @1.7GHz

*4: Typical impedance: 430Ω (typ) @900MHz/750Ω (typ) @1.7GHz

*5: Typical impedance: 580Ω (typ) @900MHz/1000Ω (typ) @1.7GHz

*6: Typical impedance: 780Ω (typ) @900MHz/1300Ω (typ) @1.7GHz

*7: Typical impedance: 1000Ω (typ) @900MHz/1700Ω (typ) @1.7GHz

*8: Typical impedance: 1400Ω (typ) @900MHz/2000Ω (typ) @1.7GHz

*9: Typical impedance: 1800Ω (typ) @900MHz/2100Ω (typ) @1.7GHz

*10: Typical impedance: 2200Ω (typ) @900MHz/2300Ω (typ) @1.7GHz

*11: Typical impedance: 2800Ω (typ) @900MHz/2350Ω (typ) @1.7GHz

*12: Typical impedance: 3000Ω (typ) @900MHz/2400Ω (typ) @1.7GHz

*13: Typical impedance: 3400Ω (typ) @900MHz/2400Ω (typ) @1.7GHz

*14: Typical impedance: 4250Ω (typ) @900MHz/2400Ω (typ) @1.7GHz

*15: Typical impedance: 4950Ω (typ) @900MHz/2350Ω (typ) @1.7GHz

*16: Typical impedance: 5800Ω (typ) @900MHz/2400Ω (typ) @1.7GHz

*17: Typical impedance: 6500Ω (typ) @900MHz/2450Ω (typ) @1.7GHz

*18: Typical impedance: 7000Ω (typ) @900MHz/2500Ω (typ) @1.7GHz

*19: Typical impedance: 5200Ω (typ) @900MHz/1600Ω (typ) @1.7GHz

*20: Typical impedance: 510Ω (typ) @900MHz/610Ω (typ) @1.7GHz

Continued from the preceding page. ↘

| Part Number | Inductance | Inductance Test Frequency | Rated Current | Max. of DC Resistance | S.R.F.* (min.) | Remark |
|----------------|-------------|---------------------------|---------------|-----------------------|----------------|--------|
| LQW15CAR27K00□ | 270nH ±10% | 10MHz | 480mA | 0.38Ω | 1200MHz | *9 |
| LQW15CAR32J00□ | 320nH ±5% | 10MHz | 420mA | 0.41Ω | 1100MHz | *10 |
| LQW15CAR32K00□ | 320nH ±10% | 10MHz | 420mA | 0.41Ω | 1100MHz | *10 |
| LQW15CAR37J00□ | 370nH ±5% | 10MHz | 360mA | 0.575Ω | 1000MHz | *11 |
| LQW15CAR37K00□ | 370nH ±10% | 10MHz | 360mA | 0.575Ω | 1000MHz | *11 |
| LQW15CAR39J00□ | 390nH±5% | 10MHz | 320mA | 0.72Ω | 950MHz | *12 |
| LQW15CAR39K00□ | 390nH±10% | 10MHz | 320mA | 0.72Ω | 950MHz | *12 |
| LQW15CAR43J00□ | 430nH ±5% | 10MHz | 360mA | 0.68Ω | 920MHz | *13 |
| LQW15CAR43K00□ | 430nH ±10% | 10MHz | 360mA | 0.68Ω | 920MHz | *13 |
| LQW15CAR50J00□ | 500nH ±5% | 10MHz | 270mA | 0.97Ω | 900MHz | *14 |
| LQW15CAR50K00□ | 500nH ±10% | 10MHz | 270mA | 0.97Ω | 900MHz | *14 |
| LQW15CAR56J00□ | 560nH ±5% | 10MHz | 270mA | 1.00Ω | 900MHz | *15 |
| LQW15CAR56K00□ | 560nH ±10% | 10MHz | 270mA | 1.00Ω | 900MHz | *15 |
| LQW15CAR64J00□ | 640nH ±5% | 10MHz | 240mA | 1.40Ω | 870MHz | *16 |
| LQW15CAR64K00□ | 640nH ±10% | 10MHz | 240mA | 1.40Ω | 870MHz | *16 |
| LQW15CAR73J00□ | 730nH ±5% | 10MHz | 200mA | 1.95Ω | 810MHz | *17 |
| LQW15CAR73K00□ | 730nH ±10% | 10MHz | 200mA | 1.95Ω | 810MHz | *17 |
| LQW15CAR80J00□ | 800nH ±5% | 10MHz | 190mA | 2.10Ω | 770MHz | *18 |
| LQW15CAR80K00□ | 800nH ±10% | 10MHz | 190mA | 2.10Ω | 770MHz | *18 |
| LQW15CA1R0K00□ | 1000nH ±10% | 10MHz | 180mA | 2.20Ω | 400MHz | *19 |
| LQW15CA2R0K00□ | 2000nH ±10% | 10MHz | 130mA | 3.20Ω | 120MHz | *20 |

Operating temp. range (Self-temp. rise included): -40 to 125°C

Class of Magnetic Shield: No Shield

For reflow soldering only

*S.R.F.: Self-Resonant Frequency

*1: Typical impedance: 100Ω (typ) @900MHz/150Ω (typ) @1.7GHz

*2: Typical impedance: 180Ω (typ) @900MHz/280Ω (typ) @1.7GHz

*3: Typical impedance: 290Ω (typ) @900MHz/360Ω (typ) @1.7GHz

*4: Typical impedance: 430Ω (typ) @900MHz/750Ω (typ) @1.7GHz

*5: Typical impedance: 580Ω (typ) @900MHz/1000Ω (typ) @1.7GHz

*6: Typical impedance: 780Ω (typ) @900MHz/1300Ω (typ) @1.7GHz

*7: Typical impedance: 1000Ω (typ) @900MHz/1700Ω (typ) @1.7GHz

*8: Typical impedance: 1400Ω (typ) @900MHz/2000Ω (typ) @1.7GHz

*9: Typical impedance: 1800Ω (typ) @900MHz/2100Ω (typ) @1.7GHz

*10: Typical impedance: 2200Ω (typ) @900MHz/2300Ω (typ) @1.7GHz

*11: Typical impedance: 2800Ω (typ) @900MHz/2350Ω (typ) @1.7GHz

*12: Typical impedance: 3000Ω (typ) @900MHz/2400Ω (typ) @1.7GHz

*13: Typical impedance: 3400Ω (typ) @900MHz/2400Ω (typ) @1.7GHz

*14: Typical impedance: 4250Ω (typ) @900MHz/2400Ω (typ) @1.7GHz

*15: Typical impedance: 4950Ω (typ) @900MHz/2350Ω (typ) @1.7GHz

*16: Typical impedance: 5800Ω (typ) @900MHz/2400Ω (typ) @1.7GHz

*17: Typical impedance: 6500Ω (typ) @900MHz/2450Ω (typ) @1.7GHz

*18: Typical impedance: 7000Ω (typ) @900MHz/2500Ω (typ) @1.7GHz

*19: Typical impedance: 5200Ω (typ) @900MHz/1600Ω (typ) @1.7GHz

*20: Typical impedance: 510Ω (typ) @900MHz/610Ω (typ) @1.7GHz

Inductance-Frequency Characteristics (Typ.)

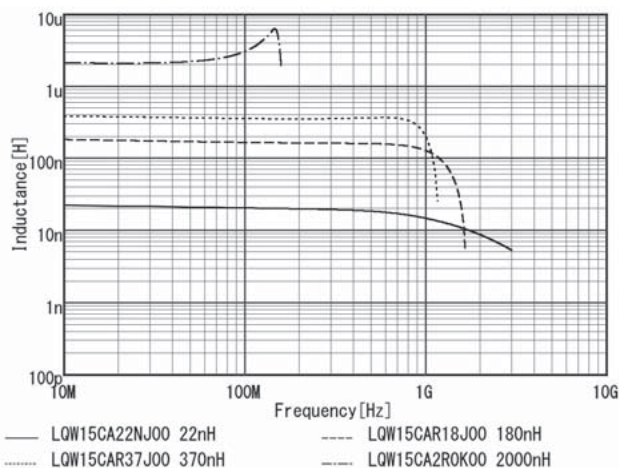

Impedance-Frequency Characteristics (Typ.)

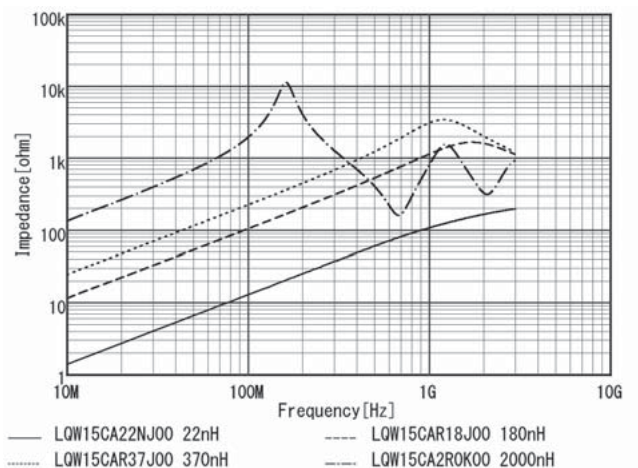

Application Specified Noise Filter

LQW18CA_00 Series 0603/1608(inch/mm)

Inductor for audio line noise suppression

Appearance/Dimensions

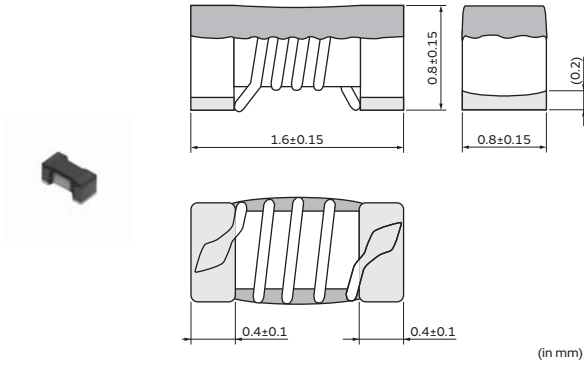

Packaging

| Code | Packaging | Minimum Quantity |
|------|---------------------|------------------|
| D | ø180mm Paper Taping | 4000 |
| J | ø330mm Paper Taping | 10000 |
| B | Packing in Bulk | 500 |

Rated Value (□: packaging code)

| Part Number | Inductance | Inductance Test Frequency | Rated Current | Max. of DC Resistance | S.R.F.* (min.) |
|----------------|------------|---------------------------|---------------|-----------------------|----------------|
| LQW18CA32NJ00□ | 32nH±5% | 10MHz | 2200mA | 0.030Ω | 3000MHz |
| LQW18CA56NJ00□ | 56nH±5% | 10MHz | 1850mA | 0.040Ω | 2200MHz |
| LQW18CA85NJ00□ | 85nH±5% | 10MHz | 1650mA | 0.048Ω | 1800MHz |
| LQW18CAR12J00□ | 120nH±5% | 10MHz | 1500mA | 0.058Ω | 1500MHz |
| LQW18CAR16J00□ | 160nH±5% | 10MHz | 1300mA | 0.075Ω | 1350MHz |
| LQW18CAR21J00□ | 210nH±5% | 10MHz | 1050mA | 0.115Ω | 1150MHz |
| LQW18CAR27J00□ | 270nH±5% | 10MHz | 900mA | 0.150Ω | 1050MHz |
| LQW18CAR33J00□ | 330nH±5% | 10MHz | 780mA | 0.200Ω | 970MHz |
| LQW18CAR40J00□ | 400nH±5% | 10MHz | 680mA | 0.260Ω | 900MHz |
| LQW18CAR48J00□ | 480nH±5% | 10MHz | 580mA | 0.350Ω | 800MHz |
| LQW18CAR58J00□ | 580nH±5% | 10MHz | 450mA | 0.460Ω | 760MHz |

Operating temp. range (Self-temp. rise not included): -40 to 85°C

Class of Magnetic Shield: No Shield

For reflow soldering only

*S.R.F.: Self-Resonant Frequency

Inductance-Frequency Characteristics (Typ.)

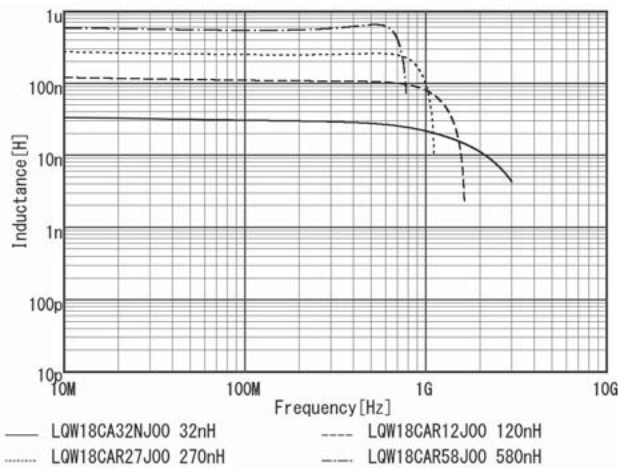

Impedance-Frequency Characteristics (Typ.)

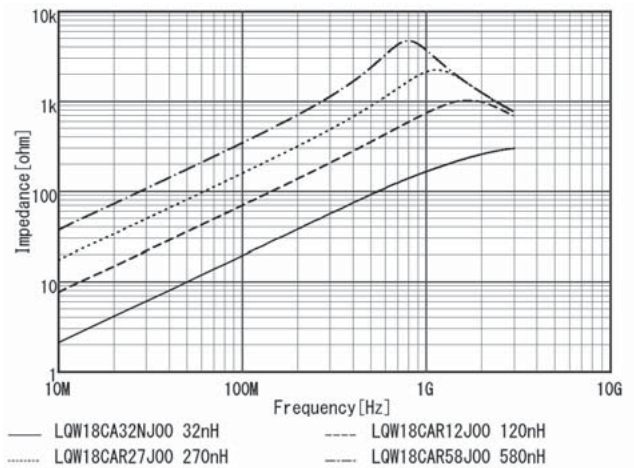

Application Specified Noise Filter (NFZ_S/NFZ_B/BLF/BLE) ⚠Caution/Notice

⚠Caution

Rating

1. About the Rated Current

Do not use products beyond the rated current as this may create excessive heat and deteriorate the insulation resistance.

the specified rated current applied to the product may cause a critical failure, such as an open circuit or burnout caused by excessive temperature rise. Please contact us in advance in case of applying surge current.

2. About Excessive Surge Current

Surge current (pulse current or rush current) higher than

Soldering and Mounting

• Self-heating

Please pay special attention when mounting NFZ03 series in close proximity to other products that radiate heat.

The heat generated by other products may deteriorate the insulation resistance and cause excessive heat in this component.

Notice

Storage and Operating Conditions

<Operating Environment>

Do not use products in a corrodible atmosphere such as acidic gases, alkaline gases, chlorine, sulfur gases, organic gases (a sea breeze, Cl₂, H₂S, NH₃, SO₂, NO₂, etc.).

Do not use products in an environment close to an organic solvent.

<Storage and Handling Requirements>

1. Storage Period

NFZ32B/S · NFZ5B series should be used within 12

months; the other series should be used within 6 months. Solderability should be checked if this period is exceeded.

2. Storage Conditions

(1) Storage temperature: -10 to +40°C

Relative humidity: 15 to 85%

Avoid sudden changes in temperature and humidity.

(2) Do not store products in a chemical atmosphere such as chlorine gas, acid or sulfide gas.

Notice (Soldering and Mounting)

1. Cleaning

Failure and degradation of a product can be caused by the cleaning method. When you clean in conditions that are not in the mounting information, please contact Murata engineering.

2. Soldering

Reliability decreases with improper soldering methods. Please solder by the standard soldering conditions shown in the mounting information.

3. Other

Noise suppression levels resulting from Murata's EMI suppression filters EMIFILr may vary, depending on the circuits and ICs used, type of noise, mounting pattern, mounting location, and other operating conditions. Be sure to check and confirm in advance the noise suppression effect of each filter, in actual circuits, etc. before applying the filter in a commercial-purpose equipment design.

Handling

1. Resin Coating

Using resin for coating/molding products may affect the product's performance. So please pay careful attention in selecting resin. Prior to use, please make a reliability evaluation with the product mounted in your application set.

when cropping the substrate, inserting and removing a connector from the substrate or tightening a screw to the substrate.

Excessive mechanical stress may cause cracking in the product.

2. Handling of Substrates

After mounting products on a substrate, do not apply any stress to the product by bending or twisting the substrate

Bending

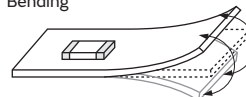

Twisting

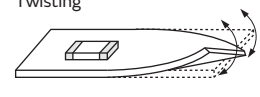

Inductor for Audio Line Noise Suppression (LQW_CA) ⚠Caution/Notice

⚠Caution

Rating

1. About the Rated Current

Do not use products beyond the rated current as this may create excessive heat and deteriorate the insulation resistance.

Notice

Storage and Operating Conditions

<Operating Environment>

Do not use products in a chemical atmosphere such as chlorine gas, acid or sulfide gas.

<Storage Requirements>

1. Storage Period

The LQW_CA series should be used within 12 months. Check solderability if this period is exceeded.

2. Storage Conditions

- (1) Store products in a warehouse in compliance with the following conditions:
Temperature: -10 to +40°C.
Humidity: 15 to 85% (relative humidity)

Do not subject products to rapid changes in temperature and humidity.

Do not store them in a chemical atmosphere such as one containing sulfurous acid gas or alkaline gas. This will prevent electrode oxidation, which causes poor solderability and possible corrosion of inductors.

- (2) Do not store products in bulk packaging to prevent collision among inductors, which causes core chipping and wire breakage.
(3) Store products on pallets to protect from humidity, dust, etc.
(4) Avoid heat shock, vibration, direct sunlight, etc.

Handling

This item is designed to have sufficient strength, but handle with care to avoid chipping or breaking its ceramic structure.

LQW_C series

- To prevent breaking the wire, avoid touching the wire wound portion with sharp materials, such as tweezers or the bristles of a cleaning brush.
- To prevent breaking the core, avoid applying excessive mechanical shock to products mounted on the board.
- In some mounting machines, when picking up components, a support pin pushes the components up from the bottom of the base tape. In this case, please remove the support pin. The support pin may damage the components and break the wire.
- In rare cases, the laser recognition cannot recognize this component. Please contact us when you use laser recognition. (There is no problem with the permeation and reflection type.)
- The product temperature rises about 40°C maximum when the permissible current is applied to LQW15C/LQW18C. Please use caution regarding the temperature of the substrate and air around the part.

<Transportation>

Do not apply excessive vibration or mechanical shock to products.

<Resin Coating>

When coating products with resin, the relatively high resin curing stress may change inductance values. For exterior coating, select resin carefully so that electrical and mechanical performance of the product is not affected. Prior to use, please evaluate reliability with the product mounted in your application set.

(LQW series)

An open circuit issue may occur by mechanical stress caused by the resin, amount/cured shape of resin, or operating conditions, etc. Some resins containing impurities or chloride may possibly generate chlorine by hydrolysis under some operating conditions, causing corrosion of the inductor wire and leading to an open circuit.

<Rated Current>

- Rated Current Based on Temperature Rise
Please refer to individual specifications.

Continued on the following page. ↗

Inductor for Audio Line Noise Suppression (LQW_CA) ⚠️Caution/Notice

Continued from the preceding page. ↘

<Handling of Substrates>

After mounting products on a substrate, do not apply any stress to the product caused by bending or twisting the substrate when cropping the substrate, inserting and removing a connector from the substrate, or tightening a screw to the substrate.

Excessive mechanical stress may cause cracking in the product.



Measuring Method

Measuring Method of Inductance/Q

1. Residual elements and stray elements of test fixtures can be described by F-parameter as shown in the following:

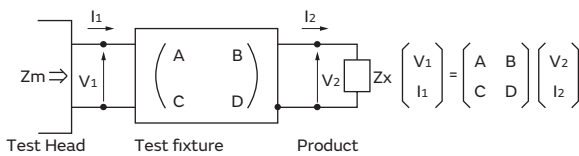

2. The impedance of chip inductors (chip coils) Z_x and measured value Z_m can be described by input/output current/voltage.

$$Z_m = \frac{V_1}{I_1}, \quad Z_x = \frac{V_2}{I_2}$$

3. Thus, the relation between Z_x and Z_m is shown in the following:

$$Z_x = \alpha \frac{Z_m - \beta}{1 - Z_m \Gamma}$$

where, $\alpha = D / A = 1$
 $\beta = B / D = Z_{sm} - (1 - Y_{om} Z_{sm}) Z_{ss}$
 $\Gamma = C / A = Y_{om}$

(Z_{sm} : measured impedance of short chip
 Z_{ss} : residual impedance of short chip*
 Y_{om} : measured admittance when opening the fixture)

*Residual inductance of short chip

| Residual Inductance | Series |
|---------------------|--------------|
| 0.556nH | LQW04CA/15CA |
| 0.771nH | LQW18CA |

4. L_x should be calculated with the following equation.

$$L_x = \frac{\text{Im}(Z_x)}{2\pi f}$$

L_x : Inductance of chip Inductors (chip coils)
 f : Measuring frequency

Application Specified Noise Filter (NFZ_S/NFZ_B/BLF/BLE) Soldering and Mounting

1. Standard Land Pattern Dimensions

Land Pattern + Solder Resist
 Land Pattern
 Solder Resist
 (in mm)

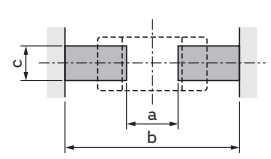
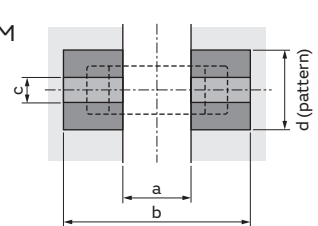
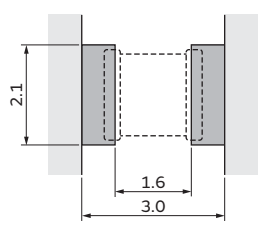
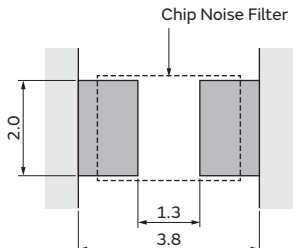
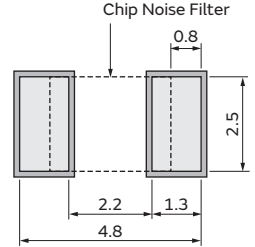
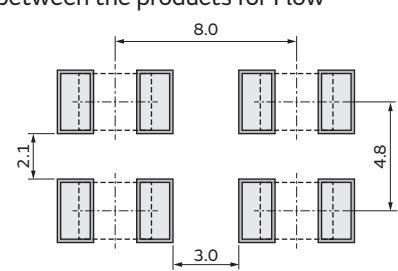
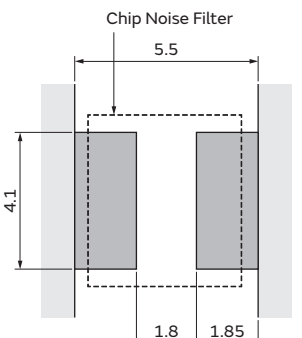
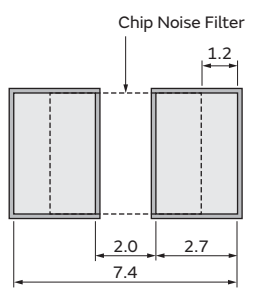
| Series | Standard Land Dimensions | | | | | | | | | | | | | | | | | | | | | | | | | | | | | | | | | | | | | | | | | | | | | | | | | | | | | |
|--|---|---|-----------|---------|-----|------------------------------------|-------|--------|------|-----|-----|-------|--------|-----|---------|-----|--|------|-------------------|-----------|---|---|---|------------------------------------|--|--|------|------|------|-------|--------|--------|-----|---------|-----|-----|-----|-------|-------|--------|-----|-----|-----|-----|-----|-----|---------|-----|-----|-----|---------|-----|-----|-----|
| NFZ03 NFZ15 NFZ18 NFZ2M | <p>●Reflow Soldering NFZ03/15</p>  <table border="1" style="margin-top: 10px;"> <thead> <tr> <th>Type</th> <th>Soldering</th> <th>a</th> <th>b</th> <th>c</th> </tr> </thead> <tbody> <tr> <td>NFZ03</td> <td>Reflow</td> <td>0.25</td> <td>0.8</td> <td>0.3</td> </tr> <tr> <td>NFZ15</td> <td>Reflow</td> <td>0.4</td> <td>1.2-1.4</td> <td>0.5</td> </tr> </tbody> </table> | Type | Soldering | a | b | c | NFZ03 | Reflow | 0.25 | 0.8 | 0.3 | NFZ15 | Reflow | 0.4 | 1.2-1.4 | 0.5 | <p>NFZ18 · NFZ2M</p>  <table border="1" style="margin-top: 10px;"> <thead> <tr> <th rowspan="2">Type</th> <th rowspan="2">Rated Current (A)</th> <th rowspan="2">Soldering</th> <th rowspan="2">a</th> <th rowspan="2">b</th> <th rowspan="2">c</th> <th colspan="3">Land Pad Thickness and Dimension d</th> </tr> <tr> <th>18μm</th> <th>35μm</th> <th>70μm</th> </tr> </thead> <tbody> <tr> <td>NFZ18</td> <td>0-1.25</td> <td>Reflow</td> <td>0.7</td> <td>1.8-2.0</td> <td>0.7</td> <td>0.7</td> <td>0.7</td> </tr> <tr> <td rowspan="3">NFZ2M</td> <td>0-1.5</td> <td rowspan="3">Reflow</td> <td rowspan="3">0.8</td> <td rowspan="3">2.4</td> <td rowspan="3">1.8</td> <td>1.8</td> <td>1.8</td> <td>1.8</td> </tr> <tr> <td>1.5-2.5</td> <td>2.4</td> <td>1.8</td> <td>1.8</td> </tr> <tr> <td>2.5-5.0</td> <td>5.0</td> <td>2.4</td> <td>1.8</td> </tr> </tbody> </table> | Type | Rated Current (A) | Soldering | a | b | c | Land Pad Thickness and Dimension d | | | 18μm | 35μm | 70μm | NFZ18 | 0-1.25 | Reflow | 0.7 | 1.8-2.0 | 0.7 | 0.7 | 0.7 | NFZ2M | 0-1.5 | Reflow | 0.8 | 2.4 | 1.8 | 1.8 | 1.8 | 1.8 | 1.5-2.5 | 2.4 | 1.8 | 1.8 | 2.5-5.0 | 5.0 | 2.4 | 1.8 |
| Type | Soldering | a | b | c | | | | | | | | | | | | | | | | | | | | | | | | | | | | | | | | | | | | | | | | | | | | | | | | | | |
| NFZ03 | Reflow | 0.25 | 0.8 | 0.3 | | | | | | | | | | | | | | | | | | | | | | | | | | | | | | | | | | | | | | | | | | | | | | | | | | |
| NFZ15 | Reflow | 0.4 | 1.2-1.4 | 0.5 | | | | | | | | | | | | | | | | | | | | | | | | | | | | | | | | | | | | | | | | | | | | | | | | | | |
| Type | Rated Current (A) | Soldering | a | b | c | Land Pad Thickness and Dimension d | | | | | | | | | | | | | | | | | | | | | | | | | | | | | | | | | | | | | | | | | | | | | | | | |
| | | | | | | 18μm | 35μm | 70μm | | | | | | | | | | | | | | | | | | | | | | | | | | | | | | | | | | | | | | | | | | | | | | |
| NFZ18 | 0-1.25 | Reflow | 0.7 | 1.8-2.0 | 0.7 | 0.7 | 0.7 | | | | | | | | | | | | | | | | | | | | | | | | | | | | | | | | | | | | | | | | | | | | | | | |
| NFZ2M | 0-1.5 | Reflow | 0.8 | 2.4 | 1.8 | 1.8 | 1.8 | 1.8 | | | | | | | | | | | | | | | | | | | | | | | | | | | | | | | | | | | | | | | | | | | | | | |
| | 1.5-2.5 | | | | | 2.4 | 1.8 | 1.8 | | | | | | | | | | | | | | | | | | | | | | | | | | | | | | | | | | | | | | | | | | | | | | |
| | 2.5-5.0 | | | | | 5.0 | 2.4 | 1.8 | | | | | | | | | | | | | | | | | | | | | | | | | | | | | | | | | | | | | | | | | | | | | | |
| NFZ2H | <p>●Reflow and Flow</p>  | | | | | | | | | | | | | | | | | | | | | | | | | | | | | | | | | | | | | | | | | | | | | | | | | | | | | |
| NFZ32 | <p>●Reflow Soldering NFZ32BW/32SW</p>  | <p>●Flow Soldering NFZ32BW</p>  <p>Distance between the products for Flow</p>  | | | | | | | | | | | | | | | | | | | | | | | | | | | | | | | | | | | | | | | | | | | | | | | | | | | | |
| NFZ5B | <p>●Reflow Soldering</p>  | <p>●Flow Soldering</p>  | | | | | | | | | | | | | | | | | | | | | | | | | | | | | | | | | | | | | | | | | | | | | | | | | | | | |

Chip Ferrite Bead

Application Specified Noise Filter

Chip EMIFIL®

Common Mode Choke Coil
Common Mode Noise Filter

Block Type EMIFIL®

EMC Absorber

Application Specified Noise Filter (NFZ_S/NFZ_B/BLF/BLE) Soldering and Mounting

Continued from the preceding page. ↘

Land Pattern + Solder Resist
 Land Pattern
 Solder Resist
 (in mm)

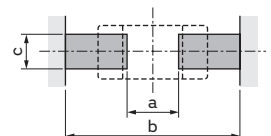
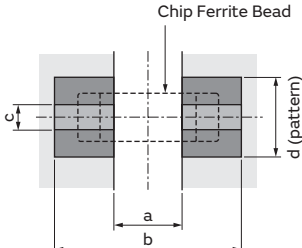
| Series | Standard Land Dimensions | | | | | | | | | | | | | | | | | | | | | | | | | | | | | | | | | | | | |
|------------------------------|---|-----------------|-------------------------------|-------------------------------|--|------------------------------------|---|------|------|-------------------|-----------|---|---|-------|------------------------------------|------|------|-------|-------|--------|-------|-----|-----------------|-------------------------------|-------------------------------|-----|---|-----|-----|-------|----|-----------------|-----|-----|------|---|---|
| BLF02 BLF03 | ●Reflow Soldering | | | | | | | | | | | | | | | | | | | | | | | | | | | | | | | | | | | | |
| |  | | | | <table border="1" style="width: 100%; text-align: center;"> <thead> <tr> <th>Type</th> <th>Soldering</th> <th>a</th> <th>b</th> <th>c</th> </tr> </thead> <tbody> <tr> <td>BLF02</td> <td>Reflow</td> <td>0.18</td> <td>0.48</td> <td>0.215</td> </tr> <tr> <td>BLF03</td> <td>Reflow</td> <td>0.25</td> <td>0.8</td> <td>0.3</td> </tr> </tbody> </table> | | | | Type | Soldering | a | b | c | BLF02 | Reflow | 0.18 | 0.48 | 0.215 | BLF03 | Reflow | 0.25 | 0.8 | 0.3 | | | | | | | | | | | | | | |
| Type | Soldering | a | b | c | | | | | | | | | | | | | | | | | | | | | | | | | | | | | | | | | |
| BLF02 | Reflow | 0.18 | 0.48 | 0.215 | | | | | | | | | | | | | | | | | | | | | | | | | | | | | | | | | |
| BLF03 | Reflow | 0.25 | 0.8 | 0.3 | | | | | | | | | | | | | | | | | | | | | | | | | | | | | | | | | |
| BLE18 BLE32 | ●Reflow and Flow | | | | | | | | | | | | | | | | | | | | | | | | | | | | | | | | | | | | |
| |  | | | | <table border="1" style="width: 100%; text-align: center;"> <thead> <tr> <th rowspan="2">Type</th> <th rowspan="2">Rated Current (A)</th> <th rowspan="2">Soldering</th> <th rowspan="2">a</th> <th rowspan="2">b</th> <th rowspan="2">c</th> <th colspan="3">Land Pad Thickness and Dimension d</th> </tr> <tr> <th>18μm</th> <th>35μm</th> <th>70μm</th> </tr> </thead> <tbody> <tr> <td>BLE18</td> <td>8</td> <td>Flow/ Reflow</td> <td>Flow/ 0.8 Reflow 0.7</td> <td>Flow/ 2.5 Reflow 2.0</td> <td>0.7</td> <td>-</td> <td>6.4</td> <td>3.3</td> </tr> <tr> <td>BLE32</td> <td>10</td> <td>Flow/ Reflow</td> <td>2.2</td> <td>4.4</td> <td>2.05</td> <td>-</td> <td>4.0 (85°C max.) 8.0 (125°C max.)</td> <td>-</td> </tr> </tbody> </table> | | | | Type | Rated Current (A) | Soldering | a | b | c | Land Pad Thickness and Dimension d | | | 18μm | 35μm | 70μm | BLE18 | 8 | Flow/ Reflow | Flow/ 0.8 Reflow 0.7 | Flow/ 2.5 Reflow 2.0 | 0.7 | - | 6.4 | 3.3 | BLE32 | 10 | Flow/ Reflow | 2.2 | 4.4 | 2.05 | - | 4.0 (85°C max.) 8.0 (125°C max.) |
| Type | Rated Current (A) | Soldering | a | b | c | Land Pad Thickness and Dimension d | | | | | | | | | | | | | | | | | | | | | | | | | | | | | | | |
| | | | | | | 18μm | 35μm | 70μm | | | | | | | | | | | | | | | | | | | | | | | | | | | | | |
| BLE18 | 8 | Flow/ Reflow | Flow/ 0.8 Reflow 0.7 | Flow/ 2.5 Reflow 2.0 | 0.7 | - | 6.4 | 3.3 | | | | | | | | | | | | | | | | | | | | | | | | | | | | | |
| BLE32 | 10 | Flow/ Reflow | 2.2 | 4.4 | 2.05 | - | 4.0 (85°C max.) 8.0 (125°C max.) | - | | | | | | | | | | | | | | | | | | | | | | | | | | | | | |

●PCB Warping

PCB should be designed so that products are not subjected to mechanical stress caused by warping the board.

Products should be located in a sideways direction (Length: $a < b$) to the mechanical stress.

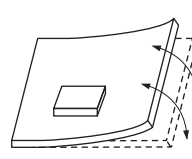

Poor example

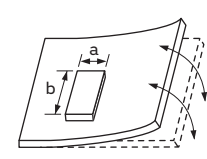

Good example

2. Solder Paste Printing and Adhesive Application

When reflow soldering the application specified noise filter, the printing must be conducted in accordance with the following cream solder printing conditions.

If too much solder is applied, the chip will be prone to damage by mechanical and thermal stress from the PCB and may crack.

Standard land dimensions should be used for resist and copper foil patterns.

When flow soldering the application specified noise filter, apply the adhesive in accordance with the following conditions.

If too much adhesive is applied, it may overflow into the land or termination areas and yield poor solderability. In contrast, if insufficient adhesive is applied, or if the adhesive is not sufficiently hardened, then the chip may become detached during the flow soldering process.

(in mm)

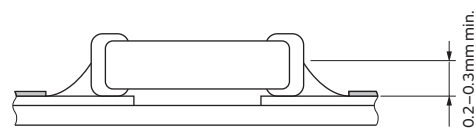
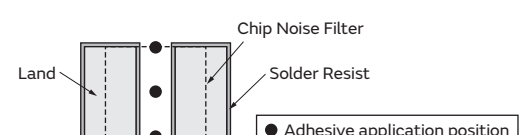
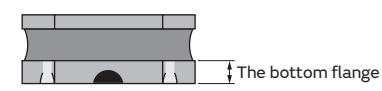
| Series | Solder Paste Printing | Adhesive Application |
|------------|--|---|
| BLE | <p>●Guideline of solder paste thickness: 50-80μm: BLF02/03 100-150μm: NFZ03/2H/2M/32/5B 100-200μm: NFZ15/18 · BLE18/32</p> <div style="text-align: center;">  </div> | <p>NFZ5B To prevent detachment of the product, 3-point adhesive application is recommended.</p> <div style="text-align: center;">  </div> <p>Amount of adhesive applied is a standard 1/2 to 2/3 of the bottom flange thickness.</p> <div style="text-align: center;">  </div> |

Continued on the following page. ↗

Application Specified Noise Filter (NFZ_S/NFZ_B/BLF/BLE) Soldering and Mounting

Continued from the preceding page. ↘

3. Standard Soldering Conditions

(1) Soldering Methods

Use flow and reflow soldering methods only.
 Use standard soldering conditions when soldering chip ferrite beads and bead inductors.
 In cases where several different parts are soldered, each having different soldering conditions, use those conditions requiring the least heat and minimum time.

Flux:

- Use rosin-based flux.
 In case of using RA type solder, products should be cleaned completely with no residual flux.
- Do not use strong acidic flux (with chlorine content exceeding 0.20wt%)
- Do not use water-soluble flux.

Solder: Use Sn-3.0Ag-0.5Cu solder. Use of Sn-Zn based solder will deteriorate performance of products.
 If using BLA series with Sn-Zn based solder, please contact Murata in advance.

For additional mounting methods, please contact Murata.

(2) Soldering Profile

● Flow Soldering Profile (Sn-3.0Ag-0.5Cu Solder)

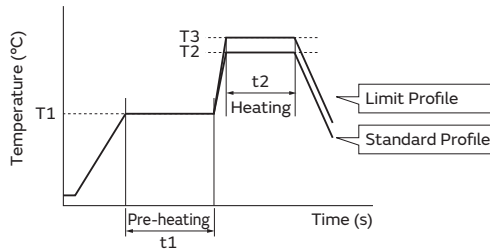

| Series | Pre-heating | | Standard Profile | | | Limit Profile | | |
|--------------------------------------|-------------|-----------|------------------|-----------|---------------|---------------|-----------|---------------|
| | Temp. (T1) | Time (t1) | Temp. (T2) | Time (t2) | Cycle of Flow | Temp. (T3) | Time (t2) | Cycle of Flow |
| NFZ (except for NFZ03/15/18/2M/32SW) | 150°C | 60s min. | 250°C | 4 to 6s | 2 times max. | 265±3°C | 5s max. | 2 times max. |
| BLE | | | | | | | | 1 time *1 |

*1 NFZ5B/32BW

● Reflow Soldering Profile (Sn-3.0Ag-0.5Cu Solder)

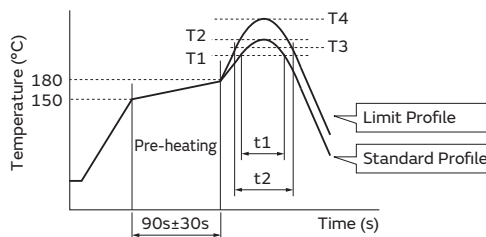

| Series | Standard Profile | | | | Limit Profile | | | |
|------------------------|------------------|------------|-----------------------|-----------------|---------------|----------|-----------------------|-----------------|
| | Heating | | Peak Temperature (T2) | Cycle of Reflow | Heating | | Peak Temperature (T4) | Cycle of Reflow |
| Temp. (T1) | Time (t1) | Temp. (T3) | | | Time (t2) | | | |
| NFZ BLF02/03 BLE | 220°C min. | 30 to 60s | 245±3°C | 2 times max. | 230°C min. | 60s max. | 260°C/10s | 2 times max. |

Continued on the following page. ↗

Application Specified Noise Filter (NFZ_S/NFZ_B/BLF/BLE) Soldering and Mounting

Continued from the preceding page. ↘

(3) Reworking with a soldering Iron

The following conditions must be strictly followed when using a soldering iron (except for NFZ03 · BLF02).

Pre-heating: 150°C 60s min.

Soldering iron power output / Tip diameter:

80W max. / ø3mm max.

Temperature of soldering iron tip / Soldering time / Times:

350°C max. / 3-4s / 2 times

Do not allow the tip of the soldering iron to directly contact the chip.

For additional methods of reworking with a soldering iron, please contact Murata engineering.

4. Cleaning

The following conditions should be observed when cleaning chip ferrite beads.

(1) Cleaning temperature: 60°C max. (40°C max. for alcohol type cleaner)

(2) Ultrasonic

Output: 20W/liter max.

Duration: 5 minutes max.

Frequency: 28 to 40kHz

(3) Cleaning Agent

The following cleaning agents have been tested on the individual components. Evaluation of final assembly should be completed prior to production.

(a) Alcohol cleaning agent

Isopropyl alcohol (IPA)

(b) Aqueous cleaning agent

Pine Alpha ST-100S (except for NFZ5B)

(4) Ensure that flux residue is completely removed.

The component should be thoroughly dried after the aqueous agent has been removed with deionized water.

Inductor for Audio Line Noise Suppression (LQW_CA) Soldering and Mounting

1. Standard Land Pattern Dimensions

A high Q value is achieved when the PCB electrode land pattern is designed so that it does not project beyond the chip Inductor's (chip coil's) electrode.

Land Pattern + Solder Resist
 Land Pattern
 Solder Resist
 (in mm)

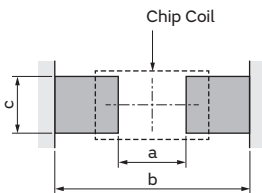
| Series | Standard Land Dimensions | | | | | | |
|-------------------------------|---|------|------|-------------|---|---|---|
| LQW04CA LQW15CA LQW18CA |  | | | Part Number | a | b | c |
| | LQW04CA | 0.45 | 1.05 | 0.48 | | | |
| | LQW15CA | 0.45 | 1.45 | 0.64 | | | |
| | LQW18CA | 0.7 | 2.2 | 1.0 | | | |

Attention should be paid to potential magnetic coupling effects when using the Inductor (coil) as a resonator.

2. Standard Soldering Conditions

(1) Soldering method

Please use reflow soldering.

Solder: Use Sn-3.0Ag-0.5Cu solder.

Flux: Use rosin-based flux, but not strongly acidic flux (with chlorine content exceeding 0.2wt%).

Do not use water-soluble flux.

The flux used for the LQW04CA/15CA/18CA series should be a rosin-based flux that includes a middle activator equivalent to 0.06wt% to 0.1wt% chlorine.

For additional mounting methods, please contact Murata.

(2) Soldering profile

● Reflow Soldering profile (Sn-3.0Ag-0.5Cu solder)

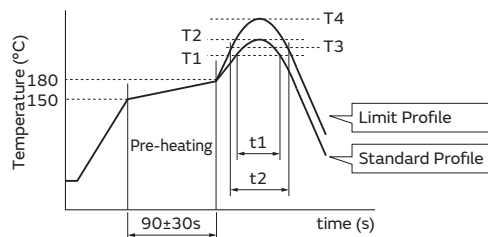

| Series | Standard Profile | | | | Limit Profile | | | |
|-------------------|------------------|-----------|-----------------------|-----------------|---------------|-----------|-----------------------|-----------------|
| | Heating | | Peak temperature (T2) | Cycle of reflow | Heating | | Peak temperature (T4) | Cycle of reflow |
| | Temp. (T1) | Time (t1) | | | Temp. (T3) | Time (t2) | | |
| LQW04CA/15CA/18CA | 220°C | 30 to 60s | 245±3°C | 2 times max. | 230°C | 60s max. | 260°C/10s | 2 times max. |

(3) Reworking with a Soldering Iron (except for LQW04C)

Preheating at 150°C for 1 minute is required. Do not directly touch the ceramic element with the tip of the soldering iron. The reworking soldering conditions are as follows:

Soldering iron power output: 80W max.

Temperature of soldering iron tip: 350°C

Diameter of soldering iron end: 3.0mm max.

Soldering time: within 3s

Please keep the fix time with the soldering iron within 2 times.

Continued on the following page. ↗

Inductor for Audio Line Noise Suppression (LQW_CA) Soldering and Mounting

Continued from the preceding page. ↘

3. Mounting Instructions

(1) Land Pattern Designing (LQW_C series)

Please follow the recommended patterns.
Otherwise, their performance, which includes electrical performance or solderability, may be affected, or result in “position shift” in the soldering process.

(2) Magnetic Coupling

Since some chip inductors (chip coils) are constructed like an open magnetic circuit, narrow spacing between inductors (coils) may cause magnetic coupling.

(3) PCB Warping

The PCB should be designed so that products are not subjected to mechanical stress caused by warping the board.

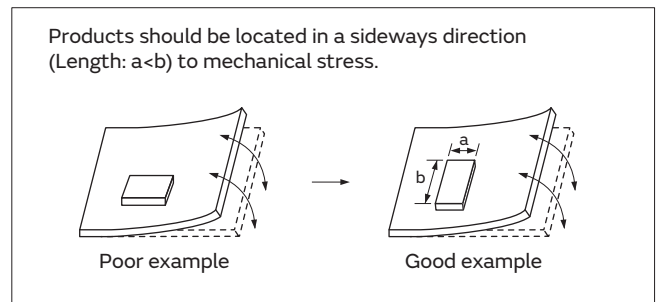

(4) Amount of Solder Paste

Excessive solder causes electrode corrosion, while insufficient solder causes low electrode bonding strength. Adjust the amount of solder paste as shown on the right so that the correct amount is applied.

Guideline of solder paste thickness

- LQW15C: 50 to 100 μ m
- LQW04C: 80 to 100 μ m
- LQW18C: 100 to 150 μ m

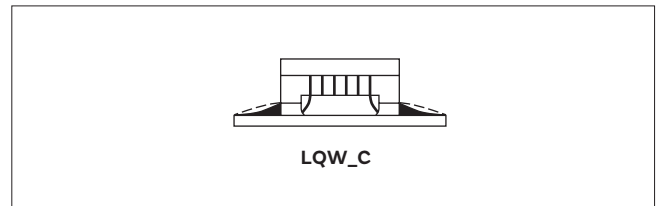

Continued on the following page. ↗

4. Cleaning

The following conditions should be observed when cleaning chip inductors (chip coils):

- (1) Cleaning temperature: 60°C max. (40°C max. for alcohol cleaning agents)
- (2) Ultrasonic
Output: 20W/l max.
Duration: 5 minutes max.
Frequency: 28 to 40kHz
Care should be taken not to cause resonance of the PCB and mounted products.
- (3) Cleaning agent
The following cleaning agents have been tested on individual components. Evaluation in complete assembly should be done prior to production.
 - (a) Alcohol cleaning agents
Isopropyl alcohol (IPA)
 - (b) Aqueous cleaning agents
Pine Alpha ST-100S

- (4) Ensure that flux residue is completely removed.
The component should be thoroughly dried after the aqueous agents have been removed with deionized water.

For additional cleaning methods, please contact Murata.

Application Specified Noise Filter (NFZ_S/NFZ_B/BLF/BLE) Packaging

Minimum Quantity and Dimensions of 8mm Width Paper / Embossed Tape

(Paper Tape)

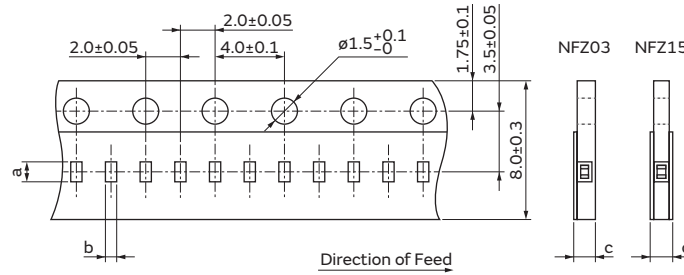

| Part Number | Dimensions | | | Minimum Qty. (pcs.) | | |
|-------------|------------|------|-----------|---------------------|-------------|------|
| | a | b | c | ø180mm Reel | ø330mm Reel | Bulk |
| NFZ03 | 0.66 | 0.36 | 0.55 max. | 15000 | - | 1000 |
| NFZ15 | 1.15 | 0.65 | 0.8 max. | 10000 | - | 1000 |

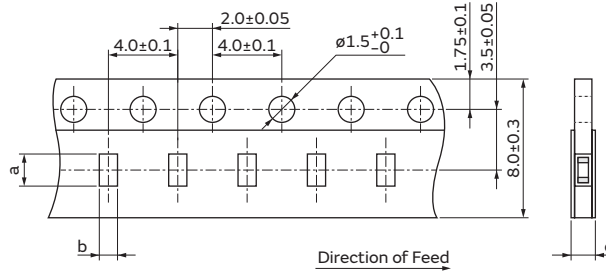

Dimension of the cavity is measured at the bottom side.

| Part Number | Dimensions | | | Minimum Qty. (pcs.) | | |
|-------------|------------|------|-----------|---------------------|-------------|------|
| | a | b | c | ø180mm Reel | ø330mm Reel | Bulk |
| NFZ18 | 1.85 | 1.05 | 1.1 max. | 4000 | - | 1000 |
| BLE18 | 1.85 | 1.05 | 0.85 max. | 4000 | 10000 | 1000 |

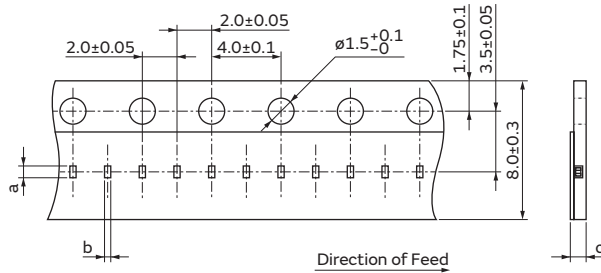

| Part Number | Dimensions | | | Minimum Qty. (pcs.) | | |
|-------------|------------|------|-----------|---------------------|-------------|------|
| | a | b | c | ø180mm Reel | ø330mm Reel | Bulk |
| BLF02 | 0.45 | 0.25 | 0.52 max. | 15000 | - | 1000 |
| BLF03 | 0.68 | 0.36 | 0.65 max. | 15000 | - | 1000 |

(in mm)

Continued on the following page. ↗

"Minimum Quantity" means the number of units of each delivery or order. The quantity should be an integral multiple of the "Minimum Quantity."

Application Specified Noise Filter (NFZ_S/NFZ_B/BLF/BLE) Packaging

Continued from the preceding page. ↘

Minimum Quantity and Dimensions of 8mm Width Paper / Embossed Tape

(Embossed Tape)

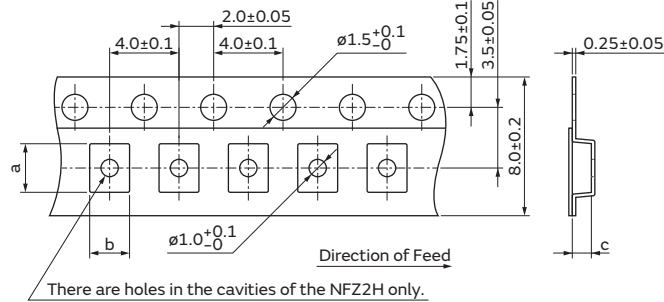

Dimension of the cavity is measured at the bottom side.

| Part Number | Dimensions | | | Minimum Qty. (pcs.) | | |
|-------------|------------|-----|-----|---------------------|-------------|------|
| | a | b | c | ø180mm Reel | ø330mm Reel | Bulk |
| NFZ2H | 2.8 | 2.3 | 1.1 | 3000 | - | 1000 |
| NFZ2M | 2.4 | 1.9 | 1.1 | 3000 | - | 1000 |

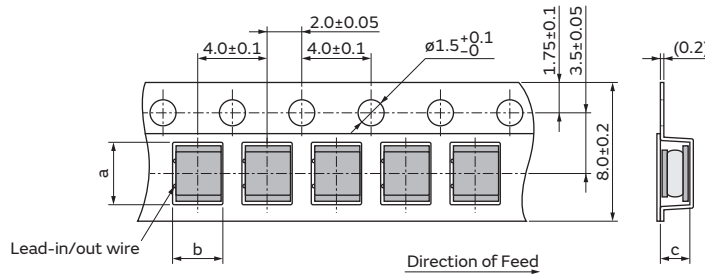

Dimension of the cavity is measured at the bottom side.

| Part Number | Dimensions | | | Minimum Qty. (pcs.) | | |
|-------------|------------|-----|-----|---------------------|-------------|------|
| | a | b | c | ø180mm Reel | ø330mm Reel | Bulk |
| NFZ32 | 3.6 | 2.9 | 1.7 | 2000 | 7500 | - |

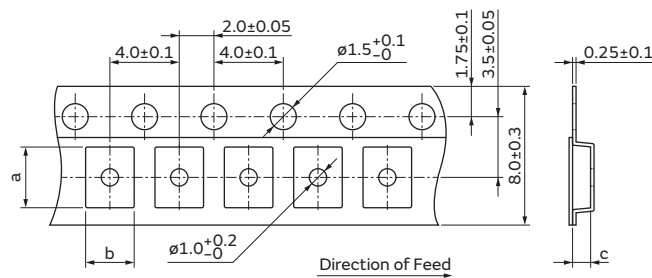

Dimension of the cavity is measured at the bottom side.

| Part Number | Dimensions | | | Minimum Qty. (pcs.) | | |
|---------------|------------|-----|------|---------------------|-------------|------|
| | a | b | c | ø180mm Reel | ø330mm Reel | Bulk |
| BLE32PN260SN1 | 3.5 | 2.8 | 1.75 | 1500 | 7000 | 1000 |
| BLE32PN300SN1 | | | 2.3 | | | |

(in mm)

Continued on the following page. ↗

"Minimum Quantity" means the number of units of each delivery or order. The quantity should be an integral multiple of the "Minimum Quantity."

Application Specified Noise Filter (NFZ_S/NFZ_B/BLF/BLE) Packaging

Continued from the preceding page. ↘

Minimum Quantity and Dimensions of 12mm Width Embossed Tape

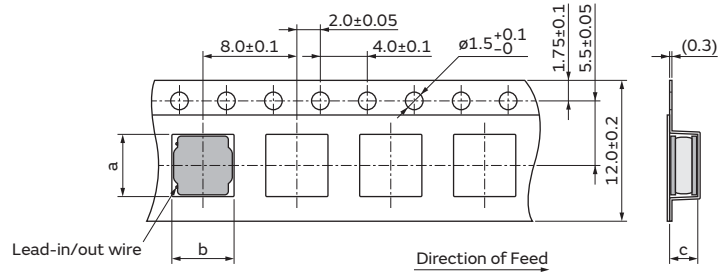

Dimension of the cavity is measured at the bottom side.

| Part Number | Dimensions | | | Minimum Qty. (pcs.) | | |
|-------------|------------|-----|-----|---------------------|-------------|------|
| | a | b | c | ø180mm Reel | ø330mm Reel | Bulk |
| NFZ5B | 5.3 | 5.3 | 2.4 | 500 | 3000 | - |

(in mm)

"Minimum Quantity" means the number of units of each delivery or order. The quantity should be an integral multiple of the "Minimum Quantity."

Inductor for Audio Line Noise Suppression (LQW_CA) Packaging

Minimum Quantity and 8mm Width Taping Dimensions

(Paper Tape)

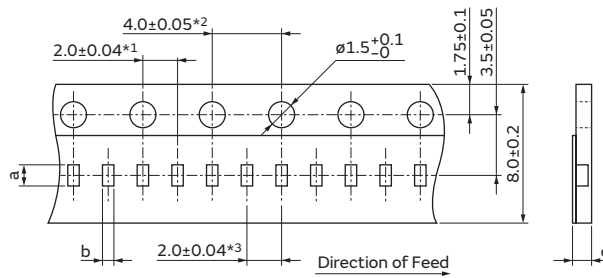

- *1 LQW15C: 2.0±0.05
- *2 LQW15C: 4.0±0.1
- *3 LQW15C: 2.0±0.05

| Part Number | Dimensions | | Total Thickness of Tape c | Packaging Code (Minimum Qty. (pcs.)) | | |
|-------------|------------|------|------------------------------|--------------------------------------|-------------|------|
| | a | b | | ø180mm Reel | ø330mm Reel | Bulk |
| LQW04C | 1.01 | 0.59 | 0.71 max. | 10000 | - | 500 |
| LQW15C | 1.22 | 0.66 | 0.9 max. | 10000 | - | 500 |

(in mm)

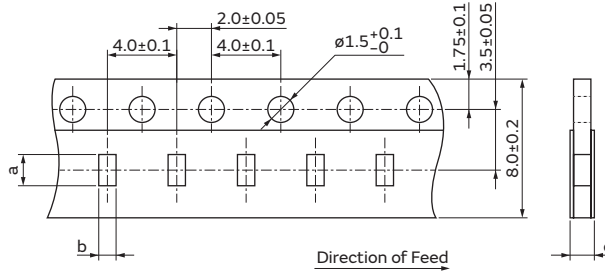

| Part Number | Dimensions | | Total Thickness of Tape c | Packaging Code (Minimum Qty. (pcs.)) | | |
|-------------|------------|-----|------------------------------|--------------------------------------|-------------|------|
| | a | b | | ø180mm Reel | ø330mm Reel | Bulk |
| LQW18C | 1.8 | 1.0 | 1.1 max. | 4000 | 10000 | 500 |

(in mm)

Chip EMIFIL® NFL/NFA/NFW/NFE Series

| | |
|------------------------------|------|
| Series Introduction | p166 |
| Part Numbering | p168 |
| Series Lineup | p170 |
| Product Detail | p172 |
| ⚠Caution/Notice | p185 |
| Soldering and Mounting | p186 |
| Packaging | p190 |

Chip EMIFIL® (NF□) Series Introduction

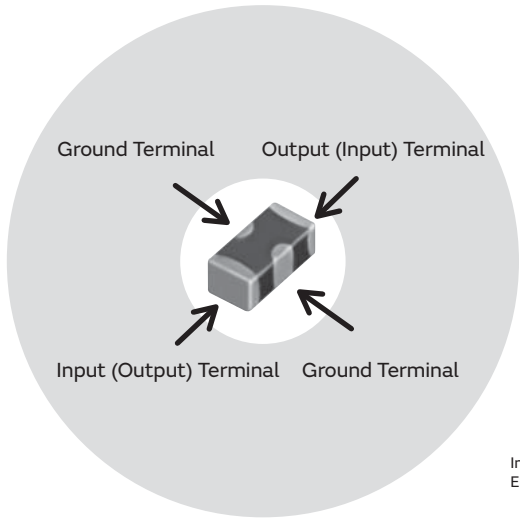

Example of 3-Terminal Capacitor Structure

Chip 3-terminal capacitor is a chip-shaped 3-terminal capacitor designed for noise suppression. Its inner structure, like a feed-through capacitor, makes its ground impedance quite low. Owing to this structure, the 3-terminal capacitor has a good noise suppression effect at a high frequency range up to several hundred MHz.

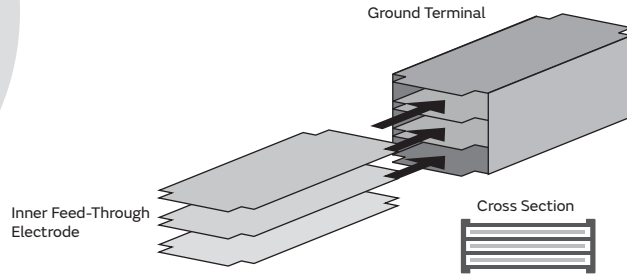

| Series | Equivalent Circuit | Part Number | |
|--|--------------------|----------------------------------|--|
| NFM Series (3-terminal capacitor) | | NFM18CC | |
| | | NFM21CC | |
| | | NFM18PC | |
| | | NFM18PS | |
| | | NFM21PC | |
| NFL / NFW / NFA Series (LC filter) | | NFL18ST | |
| | | NFL18SP | |
| | | NFL21SP NFW31SP | |
| | | NFA21SL | |
| | | NFA18SL | |
| | | NFA18SD | |
| NFE Series (Feed-through capacitor with ferrite cores) | | NFE31PT NFE61PT | |

Chip EMIFIL® (NF□) Series Introduction

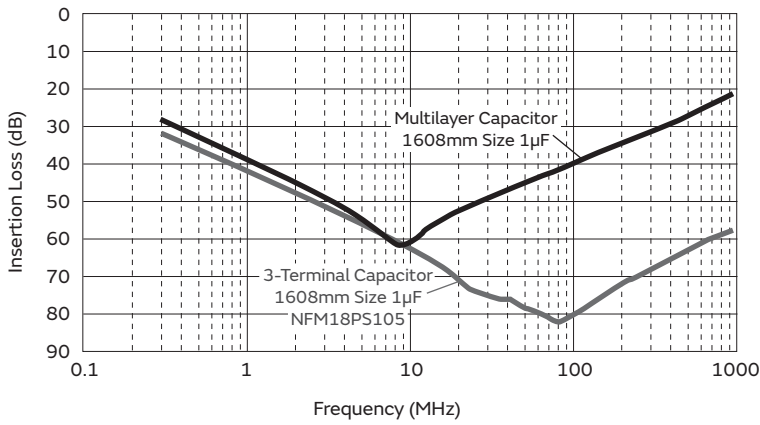

| Insertion Loss Sample | Features | Classification | | Applications | Example |
|-----------------------|--|----------------|---|--|--|
| | | Code | Description | | |
| | Standard of 3-terminal capacitor | NFM_CC | Standard type with varied capacitance | Noise suppression in low speed signal lines | · Low speed interface lines · Sensor |
| | | NFM_PC | Meet large current, high capacitance available, for power lines | Noise suppression in power lines | · Individual IC power lines |
| | Sharp insertion loss curve enables low damage to signal waveform | NFL_ST | T-type filter, effective in low impedance circuits | Noise suppression in high-speed signal lines | · High-speed interface lines · Bus lines · LCD lines · Camera I/Fs · High-speed analog lines · RGB / D terminal |
| | | NFL_SP | π-type filter, effective in high impedance circuits | | |
| | | NFW_SP | π-type filter, designed for low impedance circuits | | |
| | Meets large current, good high frequency performance because of its feed-through structure | NFA_SL | 4-line array, suitable for bus lines or flat cables | Noise suppression in power lines / low impedance lines | · Various power lines · Sensor |

● Part Numbering

Chip EMIFIL® LC Combined (1)



① Product ID

| Product ID | |
|------------|--------------|
| NF | Chip EMIFIL® |

② Structure

| Code | Structure |
|------|------------------------------|
| W | Wire Wound, LC Combined Type |
| L | Multilayer, LC Combined Type |
| E | Block, LC Combined Type |

③ Dimensions (LxW)

| Code | Dimensions (LxW) | Size Code (inch) |
|------|------------------|------------------|
| 15 | 1.0x0.5mm | 0402 |
| 18 | 1.6x0.8mm | 0603 |
| 21 | 2.0x1.25mm | 0805 |
| 31 | 3.2x1.6mm | 1206 |
| 61 | 6.8x1.6mm | 2706 |

④ Features

| Code | Features | |
|------|---------------------|---------------------------------|
| SP | | For Signal Lines, π Circuit |
| ST | For General-Purpose | For Signal Lines, T Circuit |
| PT | | For Large Current, T Circuit |

⑤ Cut-off Frequency (NFL/NFW Series)

Expressed by three figures. The unit is in hertz (Hz). The first and second figures are significant digits, and the third figure expresses the number of zeros that follow the two figures.

⑥ Capacitance (NFE Series)

Expressed by three figures. The unit is in pico-farad (pF). The first and second figures are significant digits, and the third figure expresses the number of zeros that follow the two figures.

⑥ Characteristics (NFL/NFW Series)

| Code | Characteristics |
|------|-------------------|
| H/X | Cut-off Frequency |

⑥ Characteristics (NFE Series)

| Code | Capacitance Temperature Characteristics |
|------|---|
| B | $\pm 10\%$ |
| C | $\pm 20\%, \pm 22\%$ |
| D | $+20/-30\%, +22/-33\%$ |
| E | $+20/-55\%, +22/-56\%$ |
| F | $+30/-80\%, +22/-82\%$ |
| R | $\pm 15\%$ |
| U | $-750 \pm 120\text{ppm}/^\circ\text{C}$ |
| Z | Other |

⑦ Rated Voltage

| Code | Rated Voltage |
|------|---------------|
| 1A | 10V |
| 1C | 16V |
| 1E | 25V |
| 1H | 50V |
| 2A | 100V |

⑧ Electrode

| Code | Electrode | Series |
|------|--------------------------|--------|
| 3/7 | Sn Plating | NFL |
| 4 | Lead-Free Solder Coating | NFW |
| 9 | Others | NFE |

⑨ Packaging

| Code | Packaging |
|------|---|
| K | Embossed Taping ($\phi 330\text{mm}$ Reel) |
| L | Embossed Taping ($\phi 180\text{mm}$ Reel) |
| B | Bulk |
| D | Paper Taping ($\phi 180\text{mm}$ Reel) |

Chip Ferrite Bead

Application Specified Noise Filter

Chip EMIFIL®

Common Mode Choke Coil
Common Mode Noise Filter

Block Type EMIFIL®

EMC Absorber

Chip EMIFIL® LC Combined (2)

(Part Number)

| | | | | | | | | | |
|----|---|----|----|-----|---|----|---|---|----|
| NF | A | 21 | SL | 207 | X | 1A | 4 | 5 | L |
| 1 | 2 | 3 | 4 | 5 | 6 | 7 | 8 | 9 | 10 |

① Product ID

| Product ID | Features |
|------------|--------------|
| NF | Chip EMIFIL® |

② Structure

| Code | Structure |
|------|------------|
| A | Array Type |

③ Dimensions (L x W)

| Code | Dimensions (LxW) | Size Code (inch) |
|------|------------------|------------------|
| 18 | 1.6x0.8mm | 0603 |
| 21 | 2.0x1.25mm | 0805 |

④ Features (1)

| Code | Features |
|------|-----------------------------------|
| SL | L Circuit for Signal Lines |
| SD | L Circuit for Differential Signal |

⑤ Cut-off Frequency

Expressed by three figures. The unit is in hertz (Hz). The first and second figures are significant digits, and the third figure expresses the number of zeros that follow the two figures.

⑥ Features (2)

| Code | Features |
|------|-----------------------|
| X | Expressed by a letter |
| V | |

⑦ Rated Voltage

| Code | Rated Voltage |
|------|---------------|
| 1A | 10V |

⑧ Number of Circuits

| Code | Number of Circuits |
|------|--------------------|
| 4 | 4 Circuits |

⑨ Dimensions (T)

| Code | Dimensions (T) |
|------|----------------|
| 5 | Low Profile |
| 8 | Standard |

⑩ Packaging

| Code | Packaging |
|------|-------------------------------|
| B | Bulk |
| L | Embossed Taping (ø180mm Reel) |

Series Lineup

NFL/NFA/NFW/NFE

Chip EMIFIL®

| Type | Size Code in inches (mm) | Thickness (mm) | Part Number | Rated Voltage | Capacitance | Nominal Cut-off Frequency | Rated Current |
|--|--------------------------|----------------|---------------------------------|---------------|----------------|---------------------------|---------------|
| LC Combined Type for Power Lines and Signal Lines | 1206 (3216) | 1.6 | NFE31PT220R1E9 ^{p172} | 25Vdc | 22pF±30% | - | 6A |
| | | 1.6 | NFE31PT470C1E9 ^{p172} | 25Vdc | 47pF 50/-20% | - | 6A |
| | | 1.6 | NFE31PT101C1E9 ^{p172} | 25Vdc | 100pF 80/-20% | - | 6A |
| | | 1.6 | NFE31PT221D1E9 ^{p172} | 25Vdc | 220pF 50/-20% | - | 6A |
| | | 1.6 | NFE31PT471F1E9 ^{p172} | 25Vdc | 470pF 50/-20% | - | 6A |
| | | 1.6 | NFE31PT152Z1E9 ^{p172} | 25Vdc | 1500pF 50/-20% | - | 6A |
| | | 1.6 | NFE31PT222Z1E9 ^{p172} | 25Vdc | 2200pF±50% | - | 6A |
| | 2706 (6816) | 1.6 | NFE61PT330B1H9 ^{p173} | 50Vdc | 33pF±30% | - | 2A |
| | | 1.6 | NFE61PT680B1H9 ^{p173} | 50Vdc | 68pF±30% | - | 2A |
| | | 1.6 | NFE61PT101Z1H9 ^{p173} | 50Vdc | 100pF±30% | - | 2A |
| | | 1.6 | NFE61PT181B1H9 ^{p173} | 50Vdc | 180pF±30% | - | 2A |
| | | 1.6 | NFE61PT361B1H9 ^{p173} | 50Vdc | 360pF±20% | - | 2A |
| | | 1.6 | NFE61PT681B1H9 ^{p173} | 50Vdc | 680pF±30% | - | 2A |
| | | 1.6 | NFE61PT102E1H9 ^{p173} | 50Vdc | 1000pF 80/-20% | - | 2A |
| LC Combined Multilayer Type for Signal Lines | 0603 (1608) | 0.6 | NFL18ST506H1A3 ^{p174} | 10Vdc | 110pF (Typ.) | 50MHz | 75mA |
| | | 0.6 | NFL18ST706H1A3 ^{p174} | 10Vdc | 70pF (Typ.) | 70MHz | 75mA |
| | | 0.6 | NFL18ST107H1A3 ^{p174} | 10Vdc | 50pF (Typ.) | 100MHz | 75mA |
| | | 0.6 | NFL18ST207H1A3 ^{p174} | 10Vdc | 22pF (Typ.) | 200MHz | 100mA |
| | | 0.6 | NFL18ST307H1A3 ^{p174} | 10Vdc | 16pF (Typ.) | 300MHz | 100mA |
| | | 0.6 | NFL18ST507H1A3 ^{p174} | 10Vdc | 10pF (Typ.) | 500MHz | 100mA |
| | | 0.8 | NFL18ST207X1C3 ^{p175} | 16Vdc | 25pF±20% | 200MHz | 150mA |
| | | 0.8 | NFL18ST307X1C3 ^{p175} | 16Vdc | 18pF±20% | 300MHz | 200mA |
| | | 0.8 | NFL18ST507X1C3 ^{p175} | 16Vdc | 10pF±20% | 500MHz | 200mA |
| | | 0.6 | NFL18SP157X1A3 ^{p176} | 10Vdc | 34pF±20% | 150MHz | 100mA |
| | 0805 (2012) | 0.6 | NFL18SP207X1A3 ^{p176} | 10Vdc | 24pF±20% | 200MHz | 100mA |
| | | 0.6 | NFL18SP307X1A3 ^{p176} | 10Vdc | 19pF±20% | 300MHz | 100mA |
| | | 0.6 | NFL18SP507X1A3 ^{p176} | 10Vdc | 11pF±20% | 500MHz | 100mA |
| | | 0.85 | NFL21SP106X1C3 ^{p177} | 16Vdc | 670pF±20% | 10MHz | 100mA |
| | | 0.85 | NFL21SP206X1C7 ^{p177} | 16Vdc | 240pF±20% | 20MHz | 100mA |
| | | 0.85 | NFL21SP506X1C3 ^{p177} | 16Vdc | 84pF±20% | 50MHz | 150mA |
| | | 0.85 | NFL21SP706X1C3 ^{p177} | 16Vdc | 76pF±20% | 70MHz | 150mA |
| | | 0.85 | NFL21SP107X1C3 ^{p177} | 16Vdc | 44pF±20% | 100MHz | 200mA |
| | | 0.85 | NFL21SP157X1C3 ^{p177} | 16Vdc | 28pF±20% | 150MHz | 200mA |
| | | 0.85 | NFL21SP207X1C3 ^{p177} | 16Vdc | 22pF±20% | 200MHz | 250mA |
| LC Combined Array Type for Signal Lines | 0603 (1608) | 0.6 | NFA18SL137V1A45 ^{p179} | 10Vdc | - | 130MHz | 50mA |
| | | 0.6 | NFA18SL187V1A45 ^{p179} | 10Vdc | - | 180MHz | 50mA |
| | | 0.6 | NFA18SL207V1A45 ^{p179} | 10Vdc | - | 200MHz | 50mA |
| | | 0.6 | NFA18SL227V1A45 ^{p179} | 10Vdc | - | 220MHz | 25mA |
| | | 0.5 | NFA18SL307V1A45 ^{p179} | 10Vdc | - | 300MHz | 100mA |
| | | 0.5 | NFA18SL357V1A45 ^{p179} | 10Vdc | - | 350MHz | 35mA |
| | | 0.5 | NFA18SL407V1A45 ^{p179} | 10Vdc | - | 400MHz | 100mA |
| | | 0.5 | NFA18SL487V1A45 ^{p179} | 10Vdc | - | 480MHz | 100mA |
| | | 0.6 | NFA18SL506X1A45 ^{p180} | 10Vdc | - | 50MHz | 25mA |
| | | 0.6 | NFA18SD187X1A45 ^{p181} | 10Vdc | - | 180MHz | 25mA |
| | 0805 (2012) | 0.6 | NFA18SD207X1A45 ^{p181} | 10Vdc | - | 200MHz | 25mA |
| | | 0.5 | NFA21SL287V1A45 ^{p182} | 10Vdc | - | 280MHz | 100mA |
| | | 0.5 | NFA21SL317V1A45 ^{p182} | 10Vdc | - | 310MHz | 100mA |

Continued on the following page. ↗

| Type | Size Code in inches (mm) | Thickness (mm) | Part Number | Rated Voltage | Capacitance | Nominal Cut-off Frequency | Rated Current |
|--|--------------------------|----------------|---------------------------------|---------------|-------------|---------------------------|---------------|
| LC Combined Array Type for Signal Lines | 0805 (2012) | 0.5 | NFA21SL337V1A45 ^{p182} | 10Vdc | - | 330MHz | 100mA |
| | | 0.85 | NFA21SL287V1A48 ^{p182} | 10Vdc | - | 280MHz | 100mA |
| | | 0.85 | NFA21SL317V1A48 ^{p182} | 10Vdc | - | 310MHz | 100mA |
| | | 0.85 | NFA21SL337V1A48 ^{p182} | 10Vdc | - | 330MHz | 100mA |
| | | 0.5 | NFA21SL207X1A45 ^{p183} | 10Vdc | - | 200MHz | 100mA |
| | | 0.5 | NFA21SL307X1A45 ^{p183} | 10Vdc | - | 300MHz | 100mA |
| | | 0.85 | NFA21SL506X1A48 ^{p183} | 10Vdc | - | 50MHz | 20mA |
| | | 0.85 | NFA21SL806X1A48 ^{p183} | 10Vdc | - | 80MHz | 20mA |
| | | 0.85 | NFA21SL207X1A48 ^{p183} | 10Vdc | - | 200MHz | 100mA |
| | | 0.85 | NFA21SL307X1A48 ^{p183} | 10Vdc | - | 300MHz | 100mA |
| LC Combined Wire Wound Type for Signal Lines | 1206 (3216) | 1.8 | NFW31SP106X1E4 ^{p184} | 25Vdc | - | 10MHz | 200mA |
| | | 1.8 | NFW31SP206X1E4 ^{p184} | 25Vdc | - | 20MHz | 200mA |
| | | 1.8 | NFW31SP506X1E4 ^{p184} | 25Vdc | - | 50MHz | 200mA |
| | | 1.8 | NFW31SP107X1E4 ^{p184} | 25Vdc | - | 100MHz | 200mA |
| | | 1.8 | NFW31SP157X1E4 ^{p184} | 25Vdc | - | 150MHz | 200mA |
| | | 1.8 | NFW31SP207X1E4 ^{p184} | 25Vdc | - | 200MHz | 200mA |
| | | 1.8 | NFW31SP307X1E4 ^{p184} | 25Vdc | - | 300MHz | 200mA |
| | | 1.8 | NFW31SP407X1E4 ^{p184} | 25Vdc | - | 400MHz | 200mA |
| | | 1.8 | NFW31SP507X1E4 ^{p184} | 25Vdc | - | 500MHz | 200mA |

Chip Ferrite Bead

Application Specified Noise Filter

Chip EMIFIL®

Common Mode Choke Coil
 Common Mode Noise Filter

Block Type EMIFIL®

EMC Absorber



NFE31PT Series 1206/3216(inch/mm)

Appearance/Dimensions

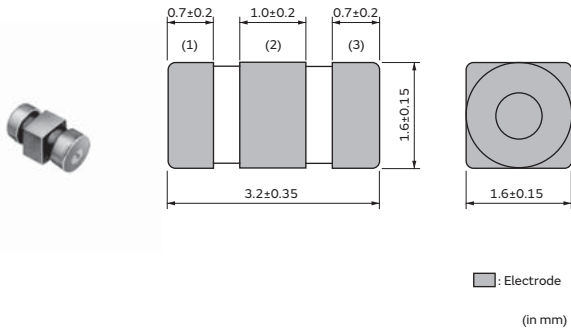

Packaging

| Code | Packaging | Minimum Quantity |
|------|----------------------|------------------|
| L | ø180mm Embossed Tape | 2000 |
| K | ø330mm Embossed Tape | 8000 |
| B | Bulk(Bag) | 500 |

Equivalent Circuit

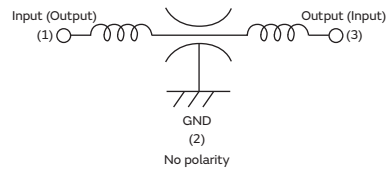

Rated Value (□: packaging code)

| Part Number | Capacitance | Rated Current | Rated Voltage | Insulation Resistance (min.) | Operating Temperature Range |
|-----------------|----------------|---------------|---------------|------------------------------|-----------------------------|
| NFE31PT220R1E9□ | 22pF ±30% | 6A | 25Vdc | 1000M ohm | -40°C to 85°C |
| NFE31PT470C1E9□ | 47pF 50/-20% | 6A | 25Vdc | 1000M ohm | -40°C to 85°C |
| NFE31PT101C1E9□ | 100pF 80/-20% | 6A | 25Vdc | 1000M ohm | -40°C to 85°C |
| NFE31PT221D1E9□ | 220pF 50/-20% | 6A | 25Vdc | 1000M ohm | -40°C to 85°C |
| NFE31PT471F1E9□ | 470pF 50/-20% | 6A | 25Vdc | 1000M ohm | -40°C to 85°C |
| NFE31PT152Z1E9□ | 1500pF 50/-20% | 6A | 25Vdc | 1000M ohm | -40°C to 85°C |
| NFE31PT222Z1E9□ | 2200pF ±50% | 6A | 25Vdc | 1000M ohm | -40°C to 85°C |

Number of Circuit: 1

Insertion Loss Characteristics

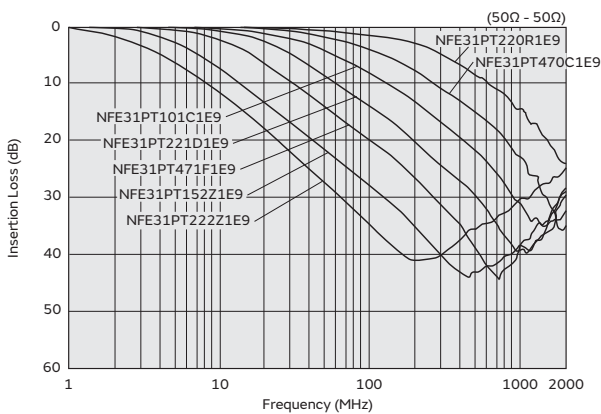

Chip Ferrite Bead

Application Specified Noise Filter

Chip EMIFIL®

Common Mode Choke Coil
Common Mode Noise Filter

Block Type EMIFIL®

EMC Absorber



NFE61PT Series 2706/6816(inch/mm)

Appearance/Dimensions

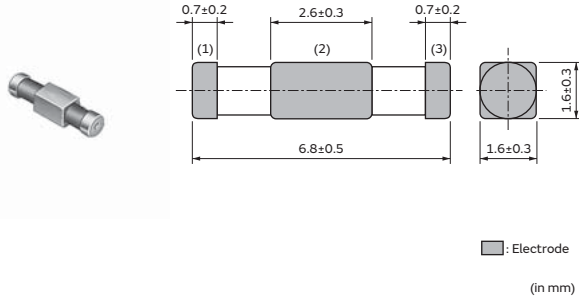

Packaging

| Code | Packaging | Minimum Quantity |
|------|----------------------|------------------|
| L | ø180mm Embossed Tape | 2500 |
| K | ø330mm Embossed Tape | 8000 |
| B | Bulk(Bag) | 500 |

Equivalent Circuit

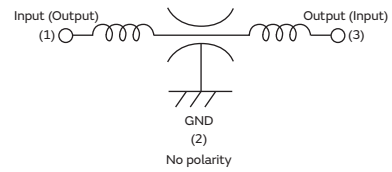

Rated Value (□: packaging code)

| Part Number | Capacitance | Rated Current | Rated Voltage | Insulation Resistance (min.) | Operating Temperature Range |
|-----------------|----------------|---------------|---------------|------------------------------|-----------------------------|
| NFE61PT330B1H9□ | 33pF ±30% | 2A | 50Vdc | 1000M ohm | -40°C to 85°C |
| NFE61PT680B1H9□ | 68pF ±30% | 2A | 50Vdc | 1000M ohm | -40°C to 85°C |
| NFE61PT101Z1H9□ | 100pF ±30% | 2A | 50Vdc | 1000M ohm | -40°C to 85°C |
| NFE61PT181B1H9□ | 180pF ±30% | 2A | 50Vdc | 1000M ohm | -40°C to 85°C |
| NFE61PT361B1H9□ | 360pF ±20% | 2A | 50Vdc | 1000M ohm | -40°C to 85°C |
| NFE61PT681B1H9□ | 680pF ±30% | 2A | 50Vdc | 1000M ohm | -40°C to 85°C |
| NFE61PT102E1H9□ | 1000pF 80/-20% | 2A | 50Vdc | 1000M ohm | -40°C to 85°C |
| NFE61PT472C1H9□ | 4700pF 80/-20% | 2A | 50Vdc | 1000M ohm | -40°C to 85°C |

Number of Circuit: 1

Insertion Loss Characteristics

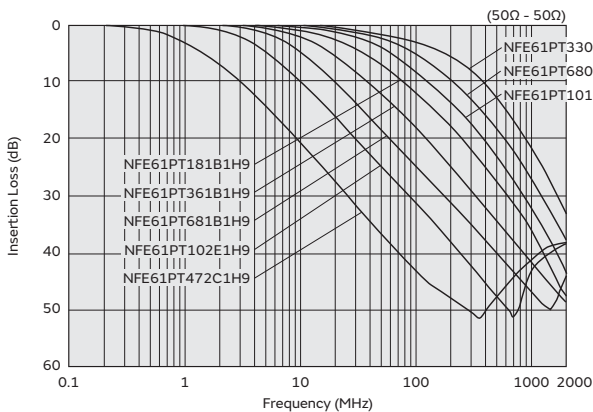

Chip EMIFIL®

NFL18ST Series 0603/1608(inch/mm)

Appearance/Dimensions

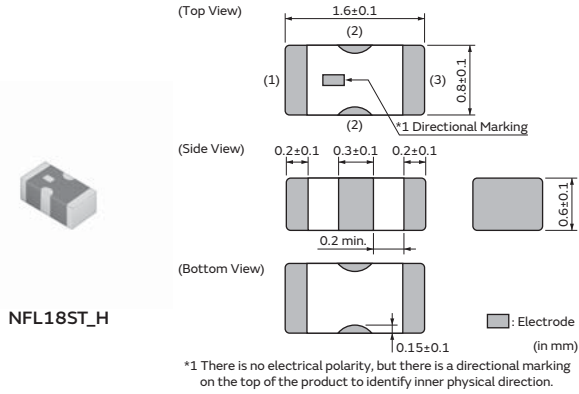

Packaging

| Code | Packaging | Minimum Quantity |
|------|-------------------|------------------|
| D | ø180mm Paper Tape | 4000 |
| B | Bulk(Bag) | 1000 |

Equivalent Circuit

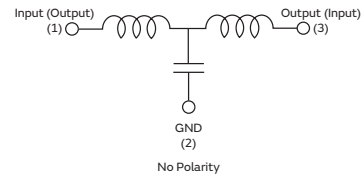

Appearance/Dimensions

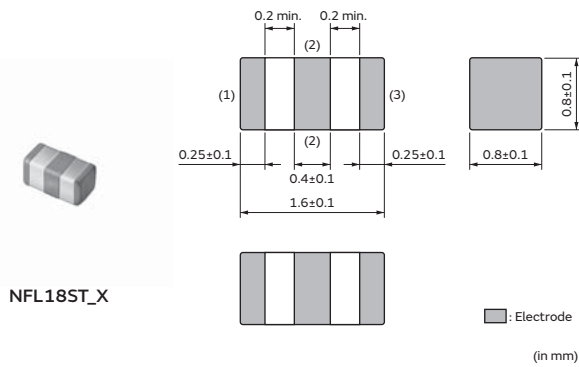

Packaging

| Code | Packaging | Minimum Quantity |
|------|-------------------|------------------|
| D | ø180mm Paper Tape | 4000 |
| B | Bulk(Bag) | 1000 |

Equivalent Circuit

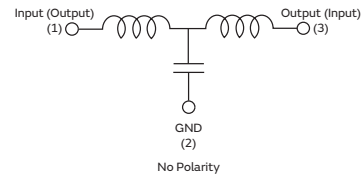

Rated Value (□: packaging code)

| Part Number | Nominal Cut-off Frequency | Capacitance | Inductance | Insertion Loss 1 | Insertion Loss 2 | Rated Current | Rated Voltage |
|-----------------|---------------------------|--------------|--------------|-----------------------|----------------------------|---------------|---------------|
| NFL18ST506H1A3□ | 50MHz | 110pF (Typ.) | 350nH (Typ.) | 6dB max.(0 to 50MHz) | 30dB min.(200 to 1000MHz) | 75mA | 10Vdc |
| NFL18ST706H1A3□ | 70MHz | 70pF (Typ.) | 230nH (Typ.) | 6dB max.(0 to 70MHz) | 30dB min.(300 to 1000MHz) | 75mA | 10Vdc |
| NFL18ST107H1A3□ | 100MHz | 50pF (Typ.) | 150nH (Typ.) | 6dB max.(0 to 100MHz) | 30dB min.(400 to 1000MHz) | 75mA | 10Vdc |
| NFL18ST207H1A3□ | 200MHz | 22pF (Typ.) | 110nH (Typ.) | 6dB max.(0 to 200MHz) | 30dB min.(800 to 2000MHz) | 100mA | 10Vdc |
| NFL18ST307H1A3□ | 300MHz | 16pF (Typ.) | 74nH (Typ.) | 6dB max.(0 to 300MHz) | 30dB min.(1200 to 2000MHz) | 100mA | 10Vdc |
| NFL18ST507H1A3□ | 500MHz | 10pF (Typ.) | 42nH (Typ.) | 6dB max.(0 to 500MHz) | 30dB min.(1700 to 2000MHz) | 100mA | 10Vdc |

Insulation Resistance (min.): 1000M ohm Withstand Voltage: 30Vdc Operating Temperature Range: -55°C to 125°C Number of Circuits: 1

Continued on the following page. ↗

Chip Ferrite Bead

Application Specified Noise Filter

Chip EMIFIL®

Common Mode Choke Coil
 Common Mode Noise Filter

Block Type EMIFIL®

EMC Absorber

Continued from the preceding page. ↘

Insertion Loss Characteristics

NFL18ST_H Series

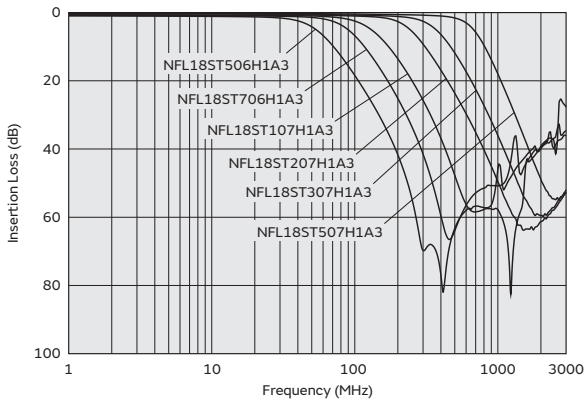

Rated Value (□: packaging code)

| Part Number | Nominal Cut-off Frequency | Capacitance | Inductance | Rated Current | Rated Voltage | Insulation Resistance (min.) | Withstand Voltage | Operating Temperature Range |
|-----------------|---------------------------|-------------|------------|---------------|---------------|------------------------------|-------------------|-----------------------------|
| NFL18ST207X1C3□ | 200MHz | 25pF±20% | 110nH±20% | 150mA | 16Vdc | 1000M ohm | 50Vdc | -55°C to 125°C |
| NFL18ST307X1C3□ | 300MHz | 18pF±20% | 62nH±20% | 200mA | 16Vdc | 1000M ohm | 50Vdc | -55°C to 125°C |
| NFL18ST507X1C3□ | 500MHz | 10pF±20% | 43nH±20% | 200mA | 16Vdc | 1000M ohm | 50Vdc | -55°C to 125°C |

Number of Circuits: 1

Insertion Loss Characteristics

NFL18ST_X Series

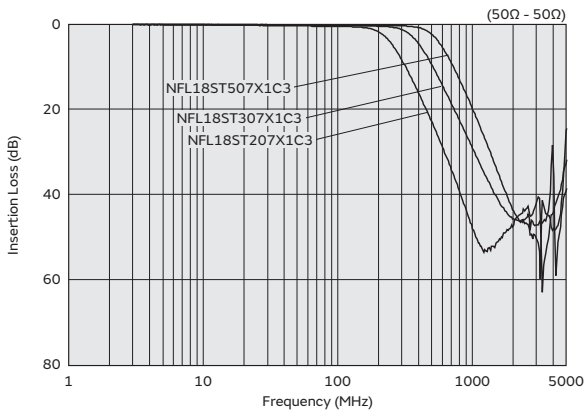



NFL18SP Series 0603/1608(inch/mm)

Appearance/Dimensions

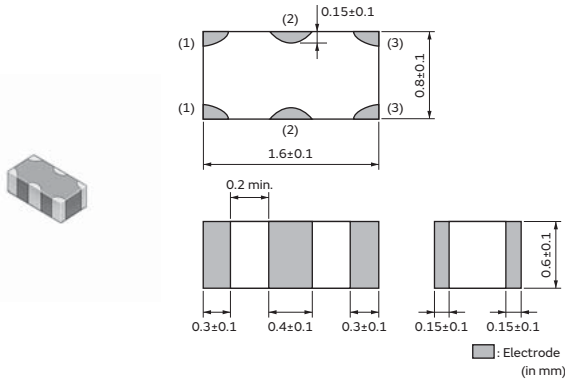

Packaging

| Code | Packaging | Minimum Quantity |
|------|-------------------|------------------|
| D | ø180mm Paper Tape | 4000 |
| B | Bulk(Bag) | 1000 |

Equivalent Circuit

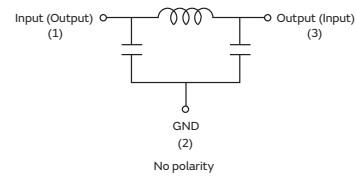

Rated Value (□: packaging code)

| Part Number | Nominal Cut-off Frequency | Capacitance | Inductance | Rated Current | Rated Voltage | Insulation Resistance (min.) | Withstand Voltage | Operating Temperature Range |
|-----------------|---------------------------|-------------|------------|---------------|---------------|------------------------------|-------------------|-----------------------------|
| NFL18SP157X1A3□ | 150MHz | 34pF±20% | 100nH±20% | 100mA | 10Vdc | 1000M ohm | 30Vdc | -55°C to 125°C |
| NFL18SP207X1A3□ | 200MHz | 24pF±20% | 80nH±20% | 100mA | 10Vdc | 1000M ohm | 30Vdc | -55°C to 125°C |
| NFL18SP307X1A3□ | 300MHz | 19pF±20% | 60nH±20% | 100mA | 10Vdc | 1000M ohm | 30Vdc | -55°C to 125°C |
| NFL18SP507X1A3□ | 500MHz | 11pF±20% | 38nH±20% | 100mA | 10Vdc | 1000M ohm | 30Vdc | -55°C to 125°C |

Number of Circuits: 1

Insertion Loss Characteristics

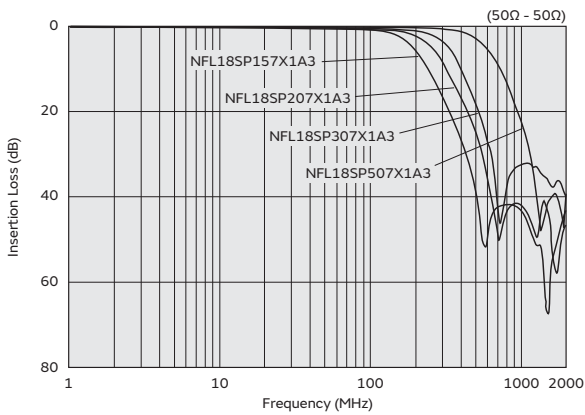



NFL21SP Series 0805/2012(inch/mm)

Appearance/Dimensions

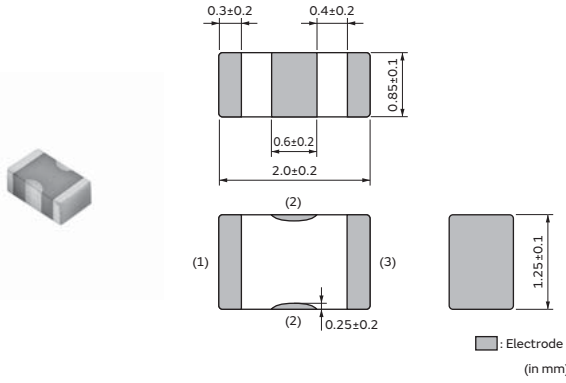

Packaging

| Code | Packaging | Minimum Quantity |
|------|-------------------|------------------|
| D | ø180mm Paper Tape | 4000 |
| B | Bulk(Bag) | 1000 |

Equivalent Circuit

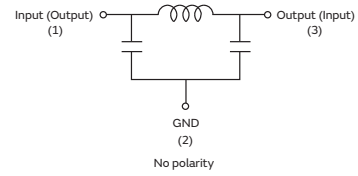

Rated Value (□: packaging code)

| Part Number | Nominal Cut-off Frequency | Capacitance | Inductance | Rated Current | Rated Voltage | Insulation Resistance (min.) | Withstand Voltage | Operating Temperature Range |
|-----------------|---------------------------|-------------|------------|---------------|---------------|------------------------------|-------------------|-----------------------------|
| NFL21SP106X1C3□ | 10MHz | 670pF±20% | 680nH±20% | 100mA | 16Vdc | 1000M ohm | 50Vdc | -55°C to 125°C |
| NFL21SP206X1C7□ | 20MHz | 240pF±20% | 700nH±20% | 100mA | 16Vdc | 1000M ohm | 50Vdc | -55°C to 125°C |
| NFL21SP506X1C3□ | 50MHz | 84pF±20% | 305nH±20% | 150mA | 16Vdc | 1000M ohm | 50Vdc | -55°C to 125°C |
| NFL21SP706X1C3□ | 70MHz | 76pF±20% | 185nH±20% | 150mA | 16Vdc | 1000M ohm | 50Vdc | -55°C to 125°C |
| NFL21SP107X1C3□ | 100MHz | 44pF±20% | 135nH±20% | 200mA | 16Vdc | 1000M ohm | 50Vdc | -55°C to 125°C |
| NFL21SP157X1C3□ | 150MHz | 28pF±20% | 128nH±20% | 200mA | 16Vdc | 1000M ohm | 50Vdc | -55°C to 125°C |
| NFL21SP207X1C3□ | 200MHz | 22pF±20% | 72nH±20% | 250mA | 16Vdc | 1000M ohm | 50Vdc | -55°C to 125°C |
| NFL21SP307X1C3□ | 300MHz | 19pF±10% | 45nH±10% | 300mA | 16Vdc | 1000M ohm | 50Vdc | -55°C to 125°C |
| NFL21SP407X1C3□ | 400MHz | 16pF±10% | 34nH±10% | 300mA | 16Vdc | 1000M ohm | 50Vdc | -55°C to 125°C |
| NFL21SP507X1C3□ | 500MHz | 12pF±10% | 31nH±10% | 300mA | 16Vdc | 1000M ohm | 50Vdc | -55°C to 125°C |

Number of Circuits: 1

Insertion Loss Characteristics

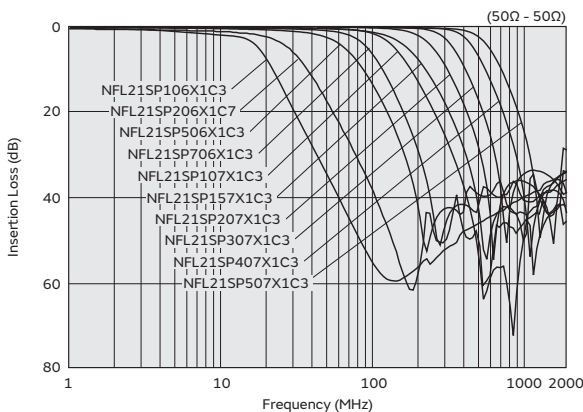

Chip EMIFIL®

NFA18SL Series 0603/1608(inch/mm)

Appearance/Dimensions

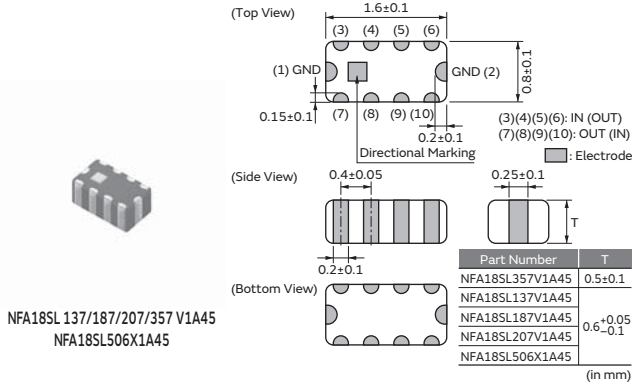

Appearance/Dimensions

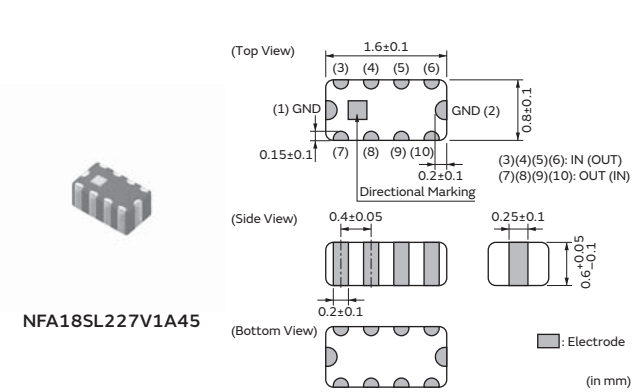

Appearance/Dimensions

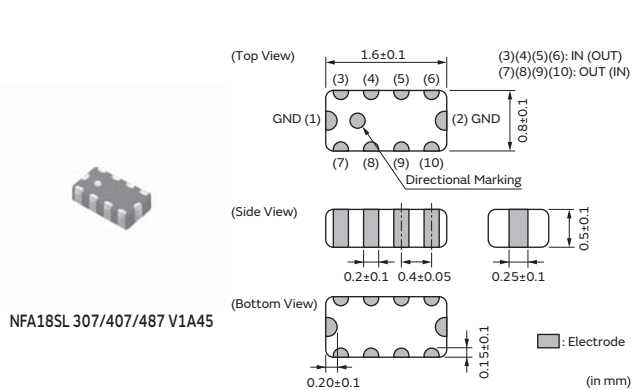

Packaging

| Code | Packaging | Minimum Quantity |
|------|----------------------|------------------|
| L | ø180mm Embossed Tape | 4000 |
| B | Bulk(Bag) | 1000 |

Equivalent Circuit

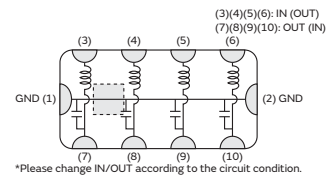

Packaging

| Code | Packaging | Minimum Quantity |
|------|----------------------|------------------|
| L | ø180mm Embossed Tape | 4000 |
| B | Bulk(Bag) | 1000 |

Equivalent Circuit

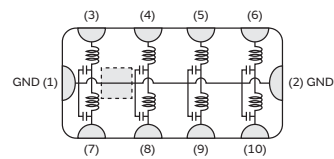

Packaging

| Code | Packaging | Minimum Quantity |
|------|----------------------|------------------|
| L | ø180mm Embossed Tape | 4000 |
| B | Bulk(Bag) | 1000 |

Equivalent Circuit

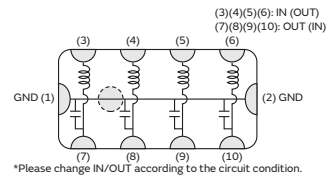

Continued on the following page. ↗

Continued from the preceding page. ↘

Rated Value (□: packaging code)

| Part Number | Nominal Cut-off Frequency | Insertion Loss (Cut-off Frequency) | Insertion Loss (470MHz) (min.) | Insertion Loss (800MHz) (min.) | Insertion Loss (900MHz) (min.) | Insertion Loss (2000MHz) (min.) | Rated Current | Rated Voltage | Insulation Resistance (min.) | Withstand Voltage |
|------------------|---------------------------|------------------------------------|--------------------------------|--------------------------------|--------------------------------|---------------------------------|---------------|---------------|------------------------------|-------------------|
| NFA18SL137V1A45□ | 130MHz | 6dB max. | 25dB | - | 25dB | - | 50mA | 10Vdc | 1000M ohm | 30Vdc |
| NFA18SL187V1A45□ | 180MHz | 6dB max. | 20dB | - | 20dB | - | 50mA | 10Vdc | 1000M ohm | 30Vdc |
| NFA18SL207V1A45□ | 200MHz | 6dB max. | 15dB | - | 15dB | - | 50mA | 10Vdc | 1000M ohm | 30Vdc |
| NFA18SL227V1A45□ | 220MHz | 6dB max. | - | - | 30dB | 30dB | 25mA | 10Vdc | 1000M ohm | 30Vdc |
| NFA18SL307V1A45□ | 300MHz | 6dB max. | - | 20dB | 20dB | - | 100mA | 10Vdc | 1000M ohm | 30Vdc |
| NFA18SL357V1A45□ | 350MHz | 6dB max. | - | - | 15dB | 13dB | 35mA | 10Vdc | 1000M ohm | 30Vdc |
| NFA18SL407V1A45□ | 400MHz | 6dB max. | - | 18dB | 18dB | - | 100mA | 10Vdc | 1000M ohm | 30Vdc |
| NFA18SL487V1A45□ | 480MHz | 6dB max. | - | 15dB | 15dB | - | 100mA | 10Vdc | 1000M ohm | 30Vdc |

Operating Temperature Range: -40°C to 85°C (NFA18SL 137/187/207/227/357 V1A45), -55°C to 125°C (NFA18SL 307/407/487 V1A45) Number of Circuits: 4

Insertion Loss Characteristics

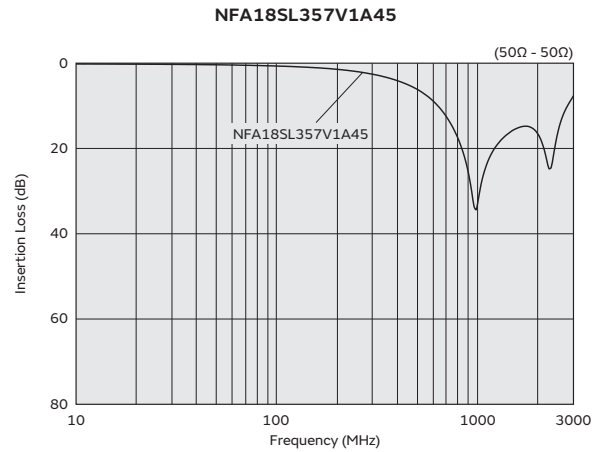
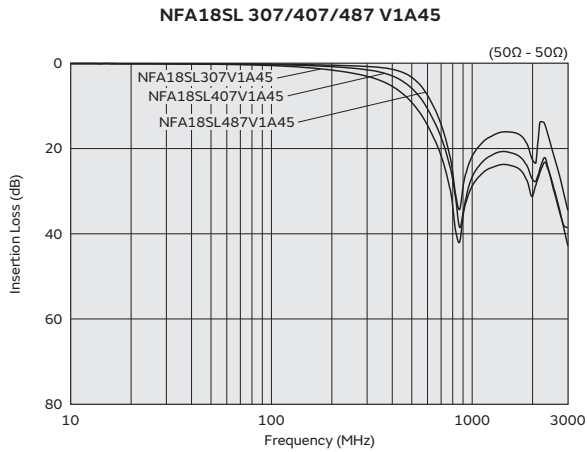
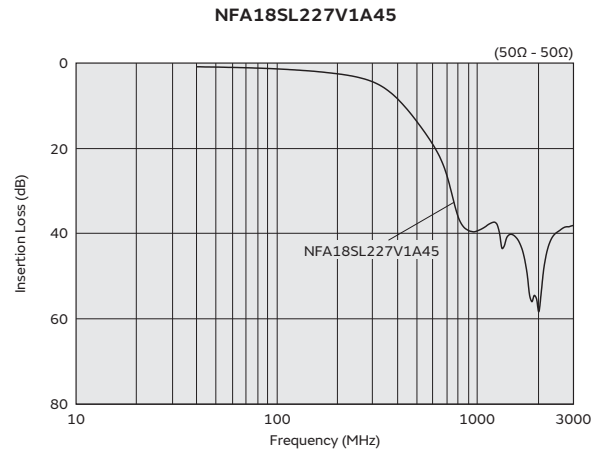
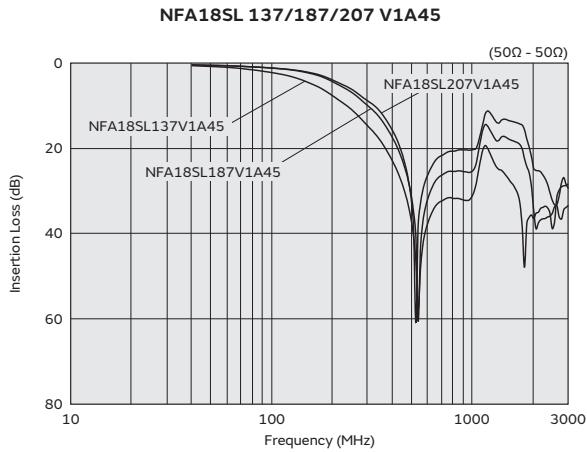

Continued on the following page. ↗

Continued from the preceding page. ↘

Rated Value (□: packaging code)

| Part Number | Nominal Cut-off Frequency | Insertion Loss (Cut-off Frequency) | Insertion Loss (500MHz) (min.) | Insertion Loss (1000MHz) (min.) | Rated Current | Rated Voltage | Insulation Resistance (min.) | Withstand Voltage |
|------------------|---------------------------|------------------------------------|--------------------------------|---------------------------------|---------------|---------------|------------------------------|-------------------|
| NFA18SL506X1A45□ | 50MHz | 6dB max. | 30dB | 25dB | 25mA | 10Vdc | 1000M ohm | 30Vdc |

Operating Temperature Range: -40°C to 85°C Number of Circuits: 4

Insertion Loss Characteristics

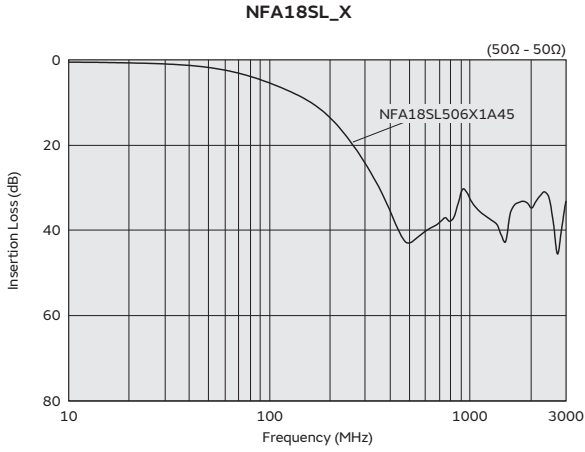



NFA18SD Series 0603/1608(inch/mm)

Appearance/Dimensions

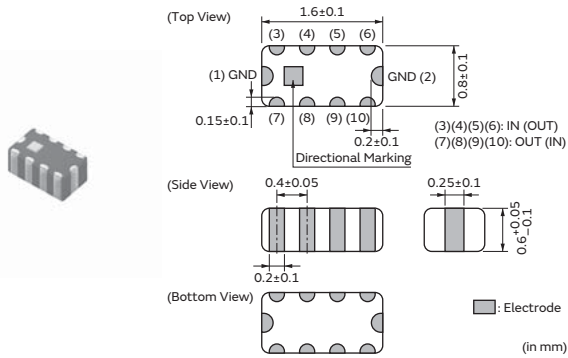

Packaging

| Code | Packaging | Minimum Quantity |
|------|----------------------|------------------|
| L | ø180mm Embossed Tape | 4000 |
| B | Bulk(Bag) | 1000 |

Equivalent Circuit

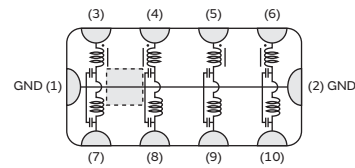

Rated Value (□: packaging code)

| Part Number | Nominal Cut-off Frequency | Insertion Loss (Cut-off Frequency) | Insertion Loss (500MHz) (min.) | Insertion Loss (900MHz) (min.) | Insertion Loss (1500MHz) (min.) | Insertion Loss (2000MHz) (min.) | Rated Current | Rated Voltage | Insulation Resistance (min.) | Withstand Voltage |
|------------------|---------------------------|------------------------------------|--------------------------------|--------------------------------|---------------------------------|---------------------------------|---------------|---------------|------------------------------|-------------------|
| NFA18SD187X1A45□ | 180MHz | 6dB max. | 15dB | 20dB | 20dB | 20dB | 25mA | 10Vdc | 1000M ohm | 30Vdc |
| NFA18SD207X1A45□ | 200MHz | 6dB max. | 13dB | 20dB | 20dB | 20dB | 25mA | 10Vdc | 1000M ohm | 30Vdc |

Operating Temperature Range: -40°C to 85°C Number of Circuits: 4

Insertion Loss Characteristics

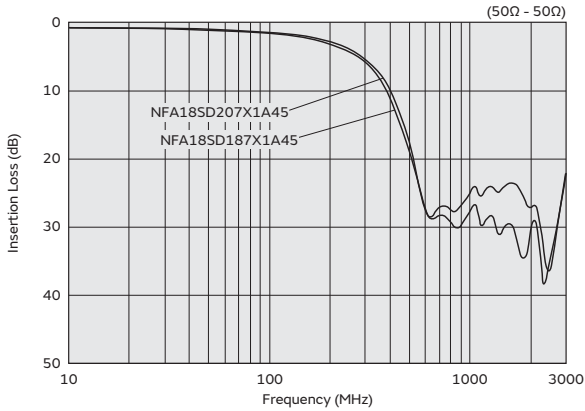



NFA21SL Series 0805/2012(inch/mm)

Appearance/Dimensions

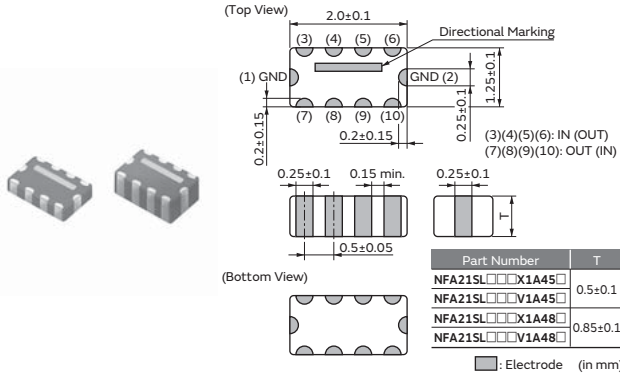

Packaging

| Code | Packaging | Minimum Quantity |
|------|----------------------|------------------|
| L | ø180mm Embossed Tape | 4000 |
| B | Bulk(Bag) | 1000 |

Equivalent Circuit

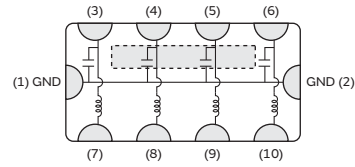

Rated Value (□: packaging code)

| Part Number | Nominal Cut-off Frequency | Insertion Loss (Cut-off Frequency) | Insertion Loss (800MHz) (min.) | Insertion Loss (900MHz) (min.) | Rated Current | Rated Voltage | Insulation Resistance (min.) | Withstand Voltage |
|------------------|---------------------------|------------------------------------|--------------------------------|--------------------------------|---------------|---------------|------------------------------|-------------------|
| NFA21SL287V1A45□ | 280MHz | 6dB max. | 25dB | 25dB | 100mA | 10Vdc | 1000M ohm | 30Vdc |
| NFA21SL317V1A45□ | 310MHz | 6dB max. | 20dB | 20dB | 100mA | 10Vdc | 1000M ohm | 30Vdc |
| NFA21SL337V1A45□ | 330MHz | 6dB max. | 15dB | 15dB | 100mA | 10Vdc | 1000M ohm | 30Vdc |
| NFA21SL287V1A48□ | 280MHz | 6dB max. | 25dB | 25dB | 100mA | 10Vdc | 1000M ohm | 30Vdc |
| NFA21SL317V1A48□ | 310MHz | 6dB max. | 20dB | 20dB | 100mA | 10Vdc | 1000M ohm | 30Vdc |
| NFA21SL337V1A48□ | 330MHz | 6dB max. | 20dB | 20dB | 100mA | 10Vdc | 1000M ohm | 30Vdc |

Operating Temperature Range: -55°C to 125°C Number of Circuits: 4

Insertion Loss Characteristics

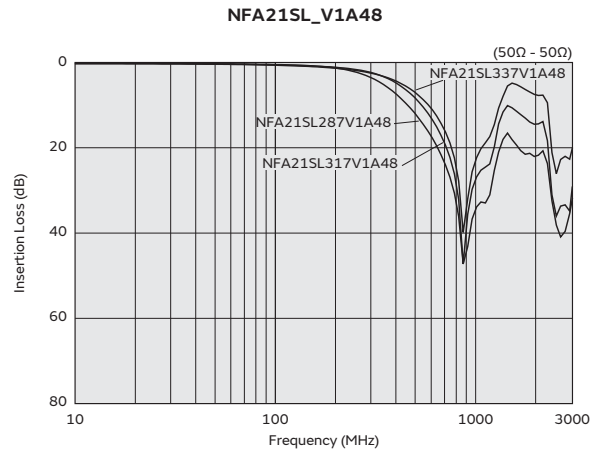
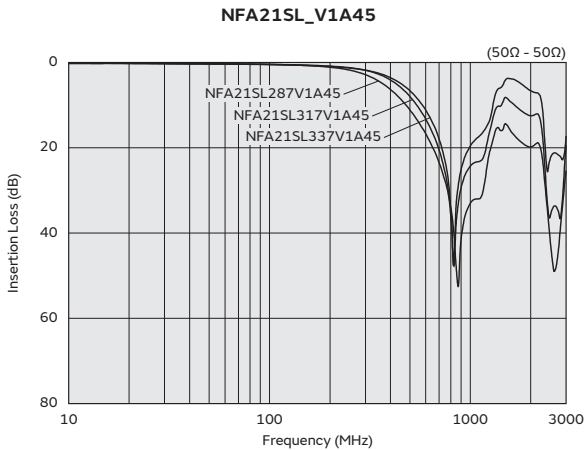

Continued on the following page. ↗

Continued from the preceding page. ↘

Rated Value (□: packaging code)

| Part Number | Nominal Cut-off Frequency | Insertion Loss (Cut-off Frequency) | Insertion Loss (500MHz) (min.) | Insertion Loss (800MHz) (min.) | Insertion Loss (1000MHz) (min.) | Rated Current | Rated Voltage | Insulation Resistance (min.) | Withstand Voltage |
|------------------|---------------------------|------------------------------------|--------------------------------|--------------------------------|---------------------------------|---------------|---------------|------------------------------|-------------------|
| NFA21SL207X1A45□ | 200MHz | 2dB to 7dB | 13dB | 25dB | 25dB | 100mA | 10Vdc | 1000M ohm | 30Vdc |
| NFA21SL307X1A45□ | 300MHz | 2dB to 7dB | 7dB | 20dB | 25dB | 100mA | 10Vdc | 1000M ohm | 30Vdc |
| NFA21SL506X1A48□ | 50MHz | 0dB to 6dB | 30dB | - | 20dB | 20mA | 10Vdc | 1000M ohm | 30Vdc |
| NFA21SL806X1A48□ | 80MHz | 2dB to 7dB | 25dB | - | 25dB | 20mA | 10Vdc | 1000M ohm | 30Vdc |
| NFA21SL207X1A48□ | 200MHz | 2dB to 7dB | 13dB | 25dB | 25dB | 100mA | 10Vdc | 1000M ohm | 30Vdc |
| NFA21SL307X1A48□ | 300MHz | 2dB to 7dB | 7dB | 20dB | 25dB | 100mA | 10Vdc | 1000M ohm | 30Vdc |

Operating Temperature Range: -55°C to 125°C Number of Circuits: 4

Insertion Loss Characteristics

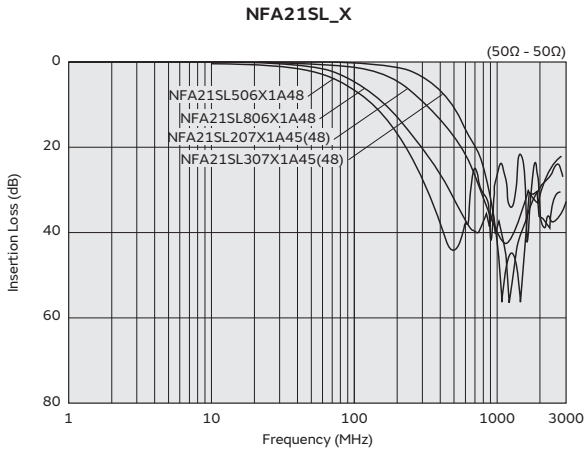

Chip Ferrite Bead

Application Specified Noise Filter

Chip EMIFIL®

Common Mode Choke Coil
 Common Mode Noise Filter

Block Type EMIFIL®

EMC Absorber



NFW31SP Series 1206/3216(inch/mm)

Appearance/Dimensions

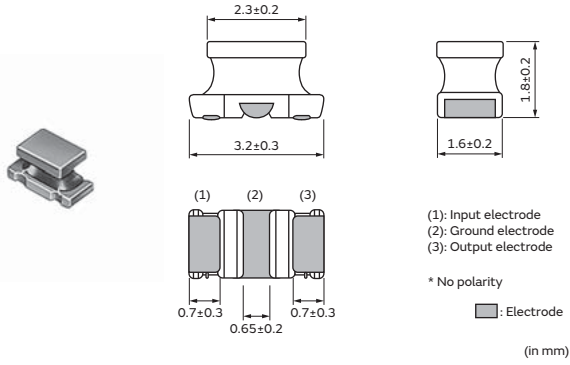

Packaging

| Code | Packaging | Minimum Quantity |
|------|----------------------|------------------|
| L | ø180mm Embossed Tape | 2000 |
| K | ø330mm Embossed Tape | 7500 |

Equivalent Circuit

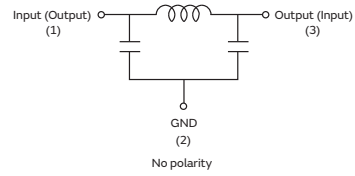

Rated Value (□: packaging code)

| Part Number | Nominal Cut-off Frequency | Insertion Loss at 10MHz | Insertion Loss at 20MHz | Insertion Loss at 50MHz | Insertion Loss at 100MHz | Insertion Loss at 150MHz | Insertion Loss at 200MHz | Insertion Loss at 300MHz | Insertion Loss at 400MHz | Insertion Loss at 500MHz | Insertion Loss at 1000MHz |
|-----------------|---------------------------|-------------------------|-------------------------|-------------------------|--------------------------|--------------------------|--------------------------|--------------------------|--------------------------|--------------------------|---------------------------|
| NFW31SP106X1E4□ | 10MHz | 6dB max. | 5dB min. | 25dB min. | 25dB min. | - | 25dB min. | - | - | 30dB min. | 30dB min. |
| NFW31SP206X1E4□ | 20MHz | - | 6dB max. | 5dB min. | 25dB min. | - | 25dB min. | - | - | 30dB min. | 30dB min. |
| NFW31SP506X1E4□ | 50MHz | - | - | 6dB max. | 10dB min. | - | 30dB min. | - | - | 30dB min. | 30dB min. |
| NFW31SP107X1E4□ | 100MHz | - | - | - | 6dB max. | - | 5dB min. | - | - | 20dB min. | 30dB min. |
| NFW31SP157X1E4□ | 150MHz | - | - | - | - | 6dB max. | - | 10dB min. | 20dB min. | 30dB min. | 30dB min. |
| NFW31SP207X1E4□ | 200MHz | - | - | - | - | - | 6dB max. | - | - | 10dB min. | 30dB min. |
| NFW31SP307X1E4□ | 300MHz | - | - | - | - | - | - | 6dB max. | - | 5dB min. | 15dB min. |
| NFW31SP407X1E4□ | 400MHz | - | - | - | - | - | - | - | 6dB max. | - | 10dB min. |
| NFW31SP507X1E4□ | 500MHz | - | - | - | - | - | - | - | - | 6dB max. | 10dB min. |

Rated Current: 200mA Rated Voltage: 25Vdc Operating Temperature Range: -40°C to 85°C Number of Circuit: 1

Insertion Loss Characteristics

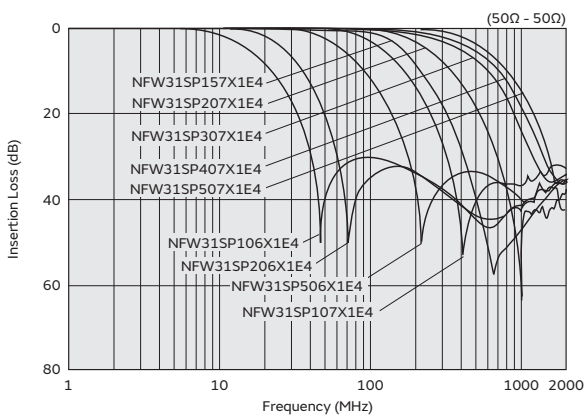

Chip EMIFIL[®] (NFL/NFA/NFW/NFE) ⚠Caution/Notice

⚠Caution

Rating

Do not use products beyond the rated current and rated voltage as this may create excessive heat and deteriorate the insulation resistance.

Notice

Storage and Operating Conditions

<Operating Environment>

Do not use products in a chemical atmosphere such as chlorine gas, acid or sulfide gas.

Do not use products in an environment close to an organic solvent.

<Storage and Handling Requirements>

1. Storage Period

Should be used within 12 months. Solderability should be

checked if this period is exceeded.

2. Storage Conditions

(1) Storage temperature: -10 to +40°C

Relative humidity: 15 to 85%

Avoid sudden changes in temperature and humidity.

(2) Do not store products in a chemical atmosphere such as chlorine gas, acid or sulfide gas.

Notice (Soldering and Mounting)

1. Cleaning

Failure and degradation of a product can be caused by the cleaning method. When you clean in conditions that are not in the mounting information, please contact Murata engineering.

2. Soldering

Reliability decreases with improper soldering methods. Please solder by the standard soldering conditions shown in the mounting information.

3. Other

Noise suppression levels resulting from Murata's EMI suppression filters EMIFIL[®] may vary, depending on the circuits and ICs used, type of noise, mounting pattern, mounting location, and other operating conditions. Be sure to check and confirm in advance the noise suppression effect of each filter, in actual circuits, etc. before applying the filter in a commercial-purpose equipment design.

Handling

1. Resin Coating

Using resin for coating/molding products may affect the product's performance.

So please pay careful attention in selecting resin.

Prior to use, please make a reliability evaluation with the product mounted in your application set.

2. Caution for Use (NFW Series)

When you hold products with a tweezer, please hold by the sides. Sharp materials, such as a pair of tweezers or other material such as cleaning brush bristles, should not touch the winding portion of this product to prevent breaking the wire. To prevent breaking the core, mechanical shock should not be applied to the products mounted on the board.

3. Handling of Substrates

After mounting products on a substrate, do not apply any stress to the product by bending or twisting the substrate when cropping the substrate, inserting and removing a connector from the substrate or tightening a screw to the substrate.

Excessive mechanical stress may cause cracking in the product.

Bending

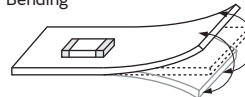

Twisting

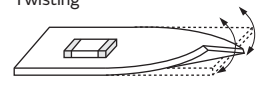

Chip EMIFIL® (NFL/NFA/NFW/NFE) Soldering and Mounting

1. Standard Land Pattern Dimensions

NF□ series suppresses noise by conducting the high-frequency noise element to ground. Therefore, to obtain maximum performance from these filters, the ground pattern should be made as large as possible during the PCB design stage. As shown below, one side of the PCB is used for chip mounting, and the other is used for grounding.

Small diameter feed-through holes are then used to connect the grounds on each side of the PCB. This reduces the high-frequency impedance of the grounding and maximizes the filter's performance.



| Series | Standard Land Dimensions |
|--|--|
| NFL18SP NFL18ST NFL21SP | <ul style="list-style-type: none"> ● Reflow Soldering <div style="display: flex; justify-content: space-around;"> <div style="text-align: center;"> <p>NFL18SP</p> <p>Small diameter thru hole $\phi 0.2-\phi 0.3$</p> </div> <div style="text-align: center;"> <p>NFL18ST</p> <p>Small diameter thru hole $\phi 0.2-\phi 0.3$</p> </div> <div style="text-align: center;"> <p>NFL21SP</p> <p>Small diameter thru hole $\phi 0.4$</p> </div> </div> |
| NFA18SL NFA18SD NFA21SL | <ul style="list-style-type: none"> ● Reflow Soldering <div style="display: flex; justify-content: space-around;"> <div style="text-align: center;"> <p>NFA18SL/NFA18SD</p> </div> <div style="text-align: center;"> <p>NFA21SL</p> <p>Small diameter thru hole $\phi 0.2$</p> </div> </div> |
| NFW31SP NFE31PT | <ul style="list-style-type: none"> ● Reflow and Flow NFW31SP ● Reflow Soldering NFE31PT <div style="text-align: center;"> <p>Small diameter thru hole $\phi 0.4$</p> </div> |
| NFE61PT | <ul style="list-style-type: none"> ● Reflow Soldering ● Flow Soldering <div style="display: flex; justify-content: space-around;"> <div style="text-align: center;"> <p>Small diameter thru hole $\phi 0.4$</p> </div> <div style="text-align: center;"> <p>Small diameter thru hole $\phi 0.4$</p> </div> </div> |

Continued on the following page. ↗

Chip Ferrite Bead

Application Specified Noise Filter

Chip EMIFIL®

Common Mode Choke Coil
Common Mode Noise Filter

Block Type EMIFIL®

EMC Absorber

Chip EMIFIL® (NFL/NFA/NFW/NFE) Soldering and Mounting

Continued from the preceding page. ↘

● PCB Warping

PCB should be designed so that products are not subjected to mechanical stress caused by warping the board.

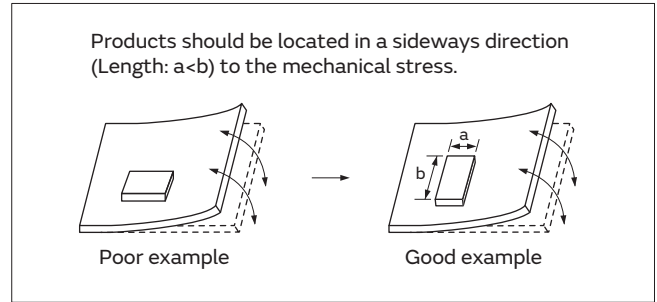

2. Solder Paste Printing and Adhesive Application

When reflow soldering the chip EMI suppression filter, the printing must be conducted in accordance with the following cream solder printing conditions.

If too much solder is applied, the chip will be prone to damage by mechanical and thermal stress from the PCB and may crack.

Standard land dimensions should be used for resist and copper foil patterns.

When flow soldering the EMI suppression filter, apply the adhesive in accordance with the following conditions. If too much adhesive is applied, it may overflow into the land or termination areas and yield poor solderability. In contrast, if insufficient adhesive is applied, or if the adhesive is not sufficiently hardened, then the chip may become detached during the flow soldering process.

| Series | Solder Paste Printing | Adhesive Application |
|--|--|---|
| NFL18SP NFL18ST NFL21SP NFA18SL NFA18SD NFA21SL | <p>●Guideline of solder paste thickness: 100-150µm: NFL, NFA18SL/18SD/21SL</p> <div style="display: flex; justify-content: space-around;"> <div style="text-align: center;"> <p>NFL18SP</p> </div> <div style="text-align: center;"> <p>NFL18ST</p> </div> </div> <div style="display: flex; justify-content: space-around; margin-top: 10px;"> <div style="text-align: center;"> <p>NFL21SP</p> </div> <div style="text-align: center;"> <p>NFA18SL/18SD</p> </div> </div> <div style="text-align: center; margin-top: 10px;"> <p>NFA21SL</p> </div> | <p style="text-align: right;">(in mm)</p> |

Continued on the following page. ↗

Chip EMIFIL® (NFL/NFA/NFW/NFE) Soldering and Mounting

Continued from the preceding page. ↘

(in mm)

| Series | Solder Paste Printing | Adhesive Application |
|----------------------------------|--|---|
| NFW31SP NFE31PT | <p>●Guideline of solder paste thickness: 150-200μm</p> | <p>NFW31SP Series Apply 0.2mg of bonding agent at each chip.</p> |
| NFE61PT | <p>●Guideline of solder paste thickness: 150-200μm</p> | <p>Apply 1.0mg of bonding agent at each chip.</p> |

3. Standard Soldering Conditions

(1) Soldering Methods

Use flow and reflow soldering methods only.
 Use standard soldering conditions when soldering chip EMI suppression filters.
 In cases where several different parts are soldered, each having different soldering conditions, use those conditions requiring the least heat and minimum time.

Flux:

- Use rosin-based flux.
 In case of using RA type solder, products should be cleaned completely with no residual flux.
- Do not use strong acidic flux (with chlorine content exceeding 0.20wt%)
- Do not use water-soluble flux.

Solder: Use Sn-3.0Ag-0.5Cu solder. Use of Sn-Zn based solder will deteriorate performance of products.

For additional mounting methods, please contact Murata.

(2) Soldering Profile

- Flow Soldering Profile
 (Sn-3.0Ag-0.5Cu Solder)

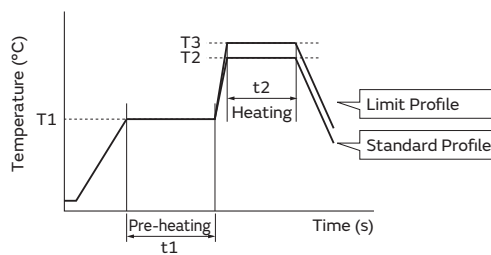

| Series | Pre-heating | | Standard Profile | | | Limit Profile | | |
|----------------|-------------|-----------|------------------|-----------|---------------|---------------|-----------|---------------|
| | Temp. (T1) | Time (t1) | Heating | | Cycle of Flow | Heating | | Cycle of Flow |
| | | | Temp. (T2) | Time (t2) | | Temp. (T3) | Time (t2) | |
| NFE61PT | 150°C | 60s min. | 250°C | 4 to 6s | 2 times max. | 265±3°C | 5s max. | 2 times max. |
| NFW31SP | 150°C | 60s min. | 250°C | 4 to 6s | 2 times max. | 265±3°C | 5s max. | 1 times max. |

Continued on the following page. ↗

Chip EMIFIL® (NFL/NFA/NFW/NFE) Soldering and Mounting

Continued from the preceding page. ↘

●Reflow Soldering Profile (Sn-3.0Ag-0.5Cu Solder)

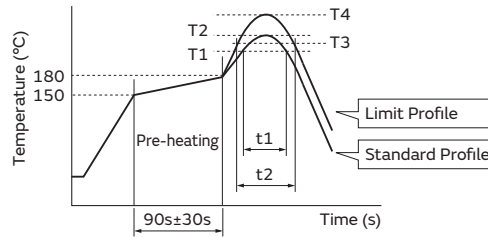

| Series | Standard Profile | | | | Limit Profile | | | |
|------------------------|------------------|-----------|-----------------------|-----------------|---------------|-----------|-----------------------|-----------------|
| | Heating | | Peak Temperature (T2) | Cycle of Reflow | Heating | | Peak Temperature (T4) | Cycle of Reflow |
| | Temp. (T1) | Time (t1) | | | Temp. (T3) | Time (t2) | | |
| NFA18S/21S NFE, NFL | 220°C min. | 30 to 60s | 245±3°C | 2 times max. | 230°C min. | 60s max. | 260°C/10s | 2 times max. |
| NFW31SP | 220°C min. | 30 to 60s | 245±3°C | 2 times max. | 230°C min. | 60s max. | 260°C/10s | 1 times max. |

(3) Reworking with a soldering Iron

The following conditions must be strictly followed when using a soldering iron.

Pre-heating: 150°C 60s min.

Soldering iron power output / Tip diameter:

30W max. / ø3mm max.

Temperature of soldering iron tip / Soldering time / Times:

350°C max. / 3-4s / 2 times*1

*1 NFE31PT152Z1E9: 280°C max. / 10s max. / 2 times

Do not allow the tip of the soldering iron to directly contact the chip.

For additional methods of reworking with a soldering iron, please contact Murata engineering.

4. Cleaning

The following conditions should be observed when cleaning chip EMI filters.

(1) Cleaning temperature: 60°C max. (40°C max. for alcohol type cleaner)

(2) Ultrasonic

Output: 20W/liter max.

Duration: 5 minutes max.

Frequency: 28 to 40kHz

(3) Cleaning Agent

The following cleaning agents have been tested on the individual components. Evaluation of final assembly should be completed prior to production.

(a) Alcohol cleaning agent

Isopropyl alcohol (IPA)

(b) Aqueous cleaning agent

Pine Alpha ST-100S

(4) Ensure that flux residue is completely removed.

The component should be thoroughly dried after the aqueous agent has been removed with deionized water.

Chip EMIFIL® (NFL/NFA/NFW/NFE) Packaging

Minimum Quantity and Dimensions of 8mm Width Paper / Embossed Tape

(Common to Paper Tape / Embossed Tape)

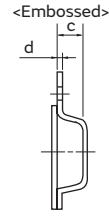
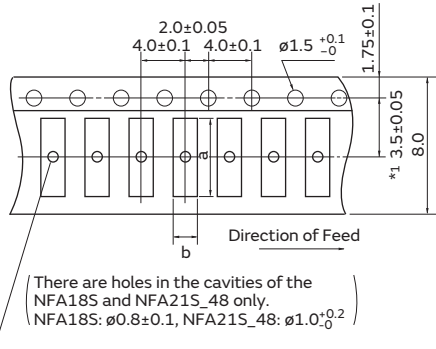

c: Depth of Cavity (Embossed Tape)

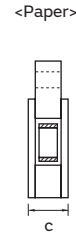

c: Total Thickness of Tape (Paper Tape)

Dimension of the cavity of embossed tape is measured at the bottom side.

| Part Number | Dimensions | | | | Minimum Qty. (pcs.) | | | | Bulk |
|-------------------|------------|------|----------|------|---------------------|---------------|-------------|---------------|------|
| | | | | | ø180mm Reel | | ø330mm Reel | | |
| | a | b | c | d | Paper Tape | Embossed Tape | Paper Tape | Embossed Tape | |
| NFL18SP/NFL18ST_H | 1.85 | 1.05 | 0.9 max. | - | 4000 | - | - | - | 1000 |
| NFL18ST_X | | | 1.1 max. | | | | | | |
| NFL21SP | 2.3 | 1.55 | 1.1 max. | - | - | - | - | - | - |
| NFA18SL/18SD | 1.8 | 1.0 | 0.7 | 0.25 | - | 4000 | - | - | 1000 |
| NFA21SL_45 | 2.30 | 1.55 | 0.7 | 0.25 | - | 4000 | - | - | 1000 |
| NFA21SL_48 | 2.25 | 1.45 | 1.05 | 0.25 | - | 4000 | - | - | 1000 |
| NFE31PT | 3.6 | 1.8 | 1.85 | 0.2 | - | 2000 | - | 8000 | 500 |
| NFW31SP | 3.6 | 1.9 | 2.0 | 0.2 | - | 2000 | - | 7500 | - |

(in mm)

Minimum Quantity and Dimensions of 12mm Width Embossed Tape

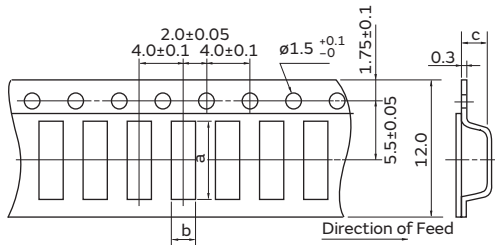

c: Depth of Cavity

Dimension of the cavity is measured at the bottom side.

| Part Number | Dimensions | | | Minimum Qty. (pcs.) | | |
|-------------|------------|-----|------|---------------------|-------------|------|
| | a | b | c | ø180mm Reel | ø330mm Reel | Bulk |
| NFE61PT | 7.2 | 1.9 | 1.75 | 2500 | 8000 | 500 |

(in mm)

"Minimum Quantity" means the number of units of each delivery or order. The quantity should be an integral multiple of the "Minimum Quantity."

Common Mode Choke Coil
· Common Mode Noise Filter
DLM/DLP/DLW/NFP/PLT Series

| | |
|------------------------------|------|
| Series Introduction | p192 |
| Part Numbering | p194 |
| Series Lineup | p198 |
| Product Detail | p202 |
| ⚠Caution/Notice | p240 |
| Soldering and Mounting | p243 |
| Packaging | p250 |

Common Mode Choke Coil/Common Mode Noise Filter (DL□/ NFP/PLT) Series Introduction

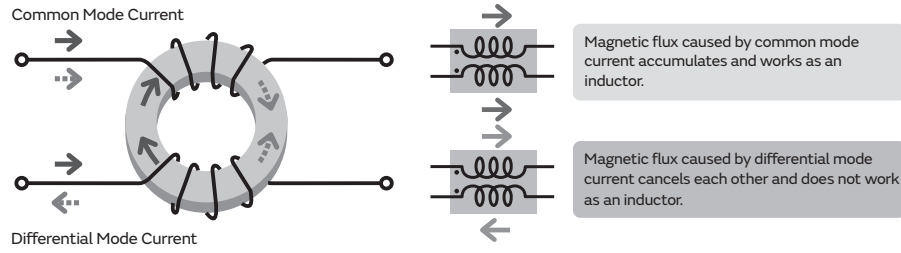

| Category | Features, Classification | Structure | Part Number | Comments | |
|------------------|---|---|--|--|---|
| For signal lines | Ultra-high cut-off frequency for high-speed differential signal lines | Multilayer type | <ul style="list-style-type: none"> DLMOQSB_HY2 DLMONSB_HY2 | <ul style="list-style-type: none"> High common impedance for outstanding noise control effectiveness. | |
| | | Film type | <ul style="list-style-type: none"> NFP0QHB_HS2 NFP0QSB_HL2 DLPOQSA DLP0NSA DLP11SA DLP11RB DLP11TB DLP2ADA | <ul style="list-style-type: none"> Low profile, small size, suitable for mobile equipment. Tight terminal pitch enables high-density layout. Very high cut-off frequency and its matching to characteristic impedance enable good transmission of high-speed signals. DLP2ADA is an array-type product incorporating two circuits. | |
| | | Winding type | <ul style="list-style-type: none"> DLW21SN_HQ2 DLW21HN_HQ2 DLW21SN_XK2 DLW21SN_XQ2 | <ul style="list-style-type: none"> Very high self-resonance frequency enables high cut-off frequency. Its matching to characteristic impedance enables good transmission of high-speed signals. DLW21HN_HQ2 is designed to be low profile. | |
| | High cut-off frequency for high-speed differential signal lines | Multilayer type | Multilayer type | <ul style="list-style-type: none"> DLM11SN_HY2 DLMOQSN DLMONSN | <ul style="list-style-type: none"> Enables noise suppression for differential signal lines without distortion in high-speed signal transmission. High cut-off frequency and its matching to characteristic impedance enable good transmission of high-speed signals. |
| | | | Film type | <ul style="list-style-type: none"> DLP0NSC DLP0NSN | <ul style="list-style-type: none"> Low profile, small size, suitable for mobile equipment. Tight terminal pitch enables high-density layout. High cut-off frequency and its matching to characteristic impedance enable good transmission of high-speed signals. |
| | | | | <ul style="list-style-type: none"> DLP11SN DLP11RN | <ul style="list-style-type: none"> Low profile, small size, suitable for mobile equipment. High cut-off frequency enables good transmission of high-speed signals. DLP11RN has low DC resistance to reduce attenuation of the signal. |
| | | Winding type | <ul style="list-style-type: none"> DLP1NDN DLP2ADN | <ul style="list-style-type: none"> Array-type product incorporating two circuits. Very high cut-off frequency and its matching to characteristic impedance enable good transmission of high-speed signals. | |
| | | | <ul style="list-style-type: none"> DLW21SN_SQ2 DLW21HN_SQ2 DLW21SN_SK2 DLW31SN | <ul style="list-style-type: none"> High impedance in the high frequency band for more effective noise suppression. High self-resonance frequency enables high cut-off frequency. DLW21HN_SQ2 is designed to be low profile. | |
| | | <ul style="list-style-type: none"> DLW21SR | <ul style="list-style-type: none"> Matches the characteristic impedance to enable good transmission of high-speed signals. Particularly suitable for the receiving side of the HDMI interface. | | |
| | For general differential signal lines | Film type | <ul style="list-style-type: none"> DLP31SN DLP31DN | <ul style="list-style-type: none"> High common impedance for outstanding noise control effectiveness. DLP31D is an array-type product incorporating two circuits. | |
| | For power lines | | Winding type | DLW44SM | <ul style="list-style-type: none"> Supports large currents (3.1 A max.) and is designed to be low profile. |
| | | | | <ul style="list-style-type: none"> DLW5AHN DLW5BSM DLW5ATN DLW5BTM | <ul style="list-style-type: none"> Supports large currents (6 A max.), suitable for input connector from an AC adaptor. DLW5AT/DLW5BT is designed to be low profile. |
| | | | | | |
| | | | | | |
| For audio lines | | Multilayer type | DLM11GN | <ul style="list-style-type: none"> Modified differential mode impedance is higher than other common mode choke coils; this feature makes it possible to suppress both common mode and differential mode noise. Ideal to maintain low distortion audio signals. | |
| For power lines | Large current automotive available | Winding type | PLT5BPH | <ul style="list-style-type: none"> Highly reliable and supports large currents (up to 5.6 A). Suitable for power lines for ADAS, IVI, and similar systems. | |
| | | Winding type cased structure | PLT10HH | <ul style="list-style-type: none"> Highly reliable and supports large currents (up to 18 A). Suitable for power lines for DC-DC converters and other electrical components in motors, HEVs, and Evs. | |

Common Mode Choke Coil/Common Mode Noise Filter (DLP/DLW Series) Noise Suppression Example

Skew Improvement Effect of Common Mode Choke Coil

Example of Skew Improvement by Common Mode Choke Coil
 (Tested using pulse generator waveform)

Waveform is equivalent to 1000Mbps signal

Waveform with intentionally made skew (skew: 100ps)

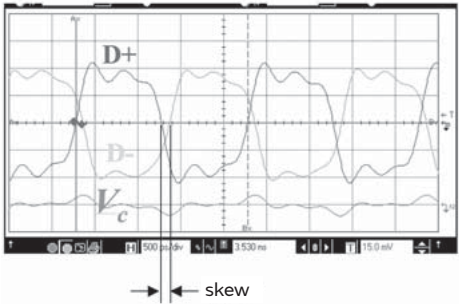

Skew is improved by common mode choke coil

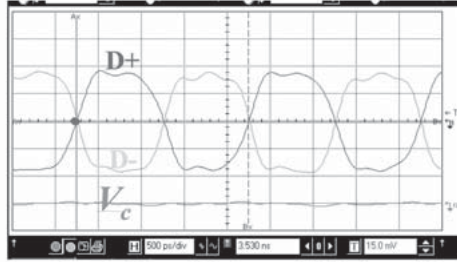

Mechanism of Skew Improvement

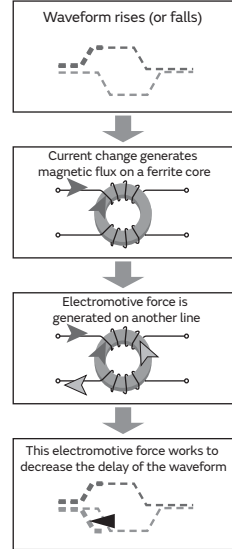

Noise Suppression of Common Mode Choke Coil in HDMI Line

Device under test / Transmitter: game machine
 / Receiver: projector

/ Cable: HDMI category 2 3m cable

Test resolution / 1080p Deep color 12bit (Data 1.11GHz) DVD play mode

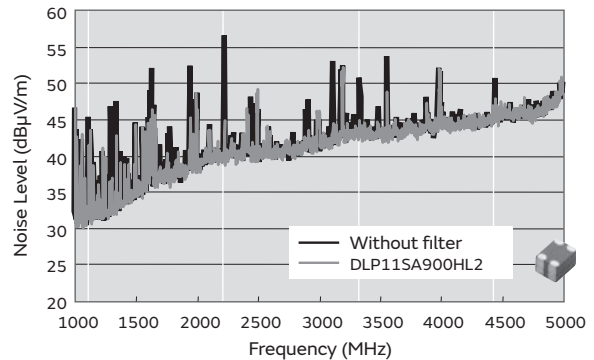
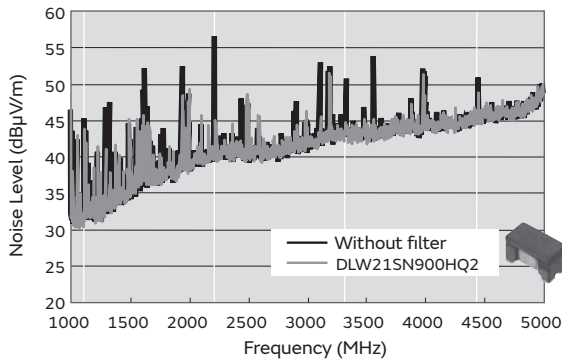

Test Example of HDMI 1.3 Waveform Transmission

~Using ESD protection device
 LXES15AAA1-100 (0.05pF)~

Signal frequency: 1.11GHz (Deep color 12bit)

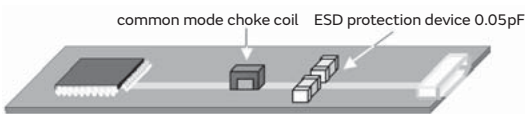
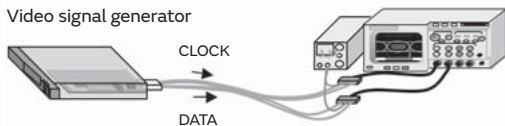

ESD protection device only

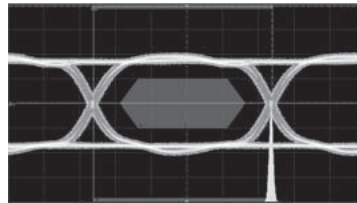

Film Type DLP11SN900HL2
 (Cut-off frequency is lowest in the table below)

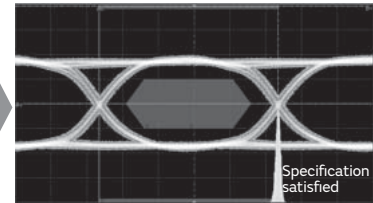

| | Wound Type DLW21SN900HQ2 | Film Type DLP11SA900HL2 | Film Type Array DLP2ADN900HL4 |
|-------------------|--|--|---------------------------------------|
| Cut-off Frequency | Over 10GHz | Around 6GHz | Around 4GHz |
| Judgment | Specification satisfied | Specification satisfied | Specification satisfied |
| Transition Time | Rise time: 83.4ps Fall time: 77.4ps | Rise time: 90.4ps Fall time: 85.5ps | Rise time: 100ps Fall time: 97.4ps |

Each common mode choke coil can keep the waveform and satisfy the specification.

● Part Numbering

Chip Common Mode Choke Coil



① Product ID

| Product ID | |
|------------|------------------------------|
| DL | Chip Common Mode Choke Coils |

② Structure

| Code | Structure |
|------|-----------------|
| M | Multilayer Type |
| P | Film Type |

③ Dimensions (LxW)

| Code | Dimensions (LxW) | Size Code (inch) |
|------|------------------|------------------|
| OQ | 0.65x0.5mm | 025020 |
| ON | 0.85x0.65mm | 03025 |
| 11 | 1.25x1.0mm | 0504 |
| 1N | 1.5x0.65mm | 05025 |
| 2A | 2.0x1.0mm | 0804 |
| 31 | 3.2x1.6mm | 1206 |

④ Features (1)

| Code | Type |
|------|--|
| S | Magnetically Shielded One Circuit Type |
| D | Magnetically Shielded Two Circuit Type |
| G | Magnetically Shielded Audio Type |
| R/T | One Circuit Low Profile Type |

⑤ Category

| Code | Category |
|------|-------------|
| A | For General |
| B | |
| C | |
| N | |

⑥ Impedance

Typical impedance at 100MHz is expressed by three figures. The unit is in ohm (Ω). The first and second figures are significant digits, and the third figure expresses the number of zeros that follow the two figures.

⑦ Circuit

| Code | Circuit |
|------|------------------------|
| S | Expressed by a letter. |
| M | |
| H | |
| U | |

⑧ Features (2)

| Code | Features |
|------|------------------------|
| D | Expressed by a letter. |
| L | |
| Y | |

⑨ Number of Signal Lines

| Code | Number of Signal Lines |
|------|------------------------|
| 2 | Two Lines |
| 4 | Four Lines |

⑩ Packaging

| Code | Packaging |
|------|--------------------------------------|
| L | Embossed Taping (ϕ 180mm Reel) |
| D | Paper Taping (ϕ 180mm Reel) |
| B | Bulk |

Chip Ferrite Bead

Application Specified Noise Filter

Chip EMIFIL®

Common Mode Choke Coil
Common Mode Noise Filter

Block Type EMIFIL®

EMC Absorber

Chip Common Mode Choke Coil

(Part Number)

| | | | | | | | | | |
|----|---|----|---|---|-----|---|---|---|---|
| DL | W | 21 | S | N | 371 | S | Q | 2 | L |
| ① | ② | ③ | ④ | ⑤ | ⑥ | ⑦ | ⑧ | ⑨ | ⑩ |

① Product ID

| Product ID | |
|------------|------------------------------|
| DL | Chip Common Mode Choke Coils |

② Structure

| Code | Structure |
|------|-----------------|
| W | Wire Wound Type |

③ Dimensions (LxW)

| Code | Dimensions (LxW) | Size Code (inch) |
|------|------------------|------------------|
| 21 | 2.0x1.2mm | 0805 |
| 31 | 3.2x1.6mm | 1206 |
| 44 | 4.0x4.0mm | 1515 |
| 5A | 5.0x3.6mm | 2014 |
| 5B | 5.0x5.0mm | 2020 |

④ Features (1)

| Code | Type |
|------|--|
| S | Magnetically Shielded One Circuit Type |
| H | Open Magnetic One Circuit Type |
| T | One Circuit Low Profile Type |

⑤ Category

| Code | Category |
|------|---------------------|
| M | For General-Purpose |
| N | |
| R | |

⑥ Impedance

Typical impedance at 100MHz is expressed by three figures. The unit is in ohm (Ω). The first and second figures are significant digits, and the third figure expresses the number of zeros that follow the two figures.

Typical impedance at peak frequency should be applied for the product whose impedance peak frequency is less than 100MHz. (DLW44SM)

⑥ Inductance (DLW43SH)

Expressed by three figures. The unit is micro-henry (μH). The first and second figures are significant digits, and the third figure expresses the number of zeros which follow the two figures.

⑦ Circuit

| Code | Circuit |
|------|------------------------|
| S | Expressed by a letter. |
| M | |
| H | |
| T | |
| X | |

⑧ Features (2)

| Code | Features |
|------|------------------------|
| K | Expressed by a letter. |
| Q | |

⑨ Number of Signal Lines

| Code | Number of Signal Lines |
|------|------------------------|
| 2 | Two Lines |

⑩ Packaging

| Code | Packaging |
|------|--------------------------------------|
| K | Embossed Taping (ϕ 330mm Reel) |
| L | Embossed Taping (ϕ 180mm Reel) |
| B | Bulk |

Common Mode Noise Filter

(Part Number)

| | | | | | | | | | |
|----|---|----|---|---|-----|---|---|---|----|
| NF | P | OR | S | N | 112 | H | L | 2 | D |
| 1 | 2 | 3 | 4 | 5 | 6 | 7 | 8 | 9 | 10 |

① Product ID

| Product ID | |
|------------|--------------|
| NF | Chip EMIFIL® |

② Structure

| Code | Structure |
|------|------------------------------------|
| P | Film Type Common Mode Noise Filter |

③ Dimensions (LxW)

| Code | Dimensions (LxW) | Size Code (inch) |
|------|------------------|------------------|
| OQ | 0.65x0.5mm | 025020 |

④ Features (1)

| Code | Type |
|------|-------------------------------|
| S | Standard 1 Circuit |
| H | High Insertion Loss 1 Circuit |

⑤ Category

| Code | Category |
|------|------------------------|
| B | High Cut-Off Frequency |

⑥ SRF

Typical SRF of common mode noise suppression effect is expressed by three figures. The unit is in MHz. The first and second figures are significant digits, and the third figure expresses the number of zeros that follow the two figures.

⑦ Circuit

| Code | Circuit |
|------|-----------------------|
| H | Expressed by a letter |

⑧ Features (2)

| Code | Features |
|------|-----------------------|
| L | Expressed by a letter |
| S | |

⑨ Number of Signal Lines

| Code | Number of Signal Lines |
|------|------------------------|
| 2 | Two Lines |

⑩ Packaging

| Code | Packaging |
|------|----------------------------|
| D | Paper Taping (ø180mm Reel) |
| B | Bulk |

Common Mode Choke Coil

(Part Number)

| | | | | | | | | |
|----|---|-----|---|-----|-----|---|---|---|
| PL | T | 10H | H | 102 | 6R0 | P | N | B |
| ① | ② | ③ | ④ | ⑤ | ⑥ | ⑦ | ⑧ | ⑨ |

① Product ID

| Product ID | |
|------------|-------------------------|
| PL | Common Mode Choke Coils |

② Type

| Code | Type |
|------|---------|
| T | DC Type |

③ Applications

| Code | Applications |
|------|---------------------------------|
| 10H | For DC Line High-frequency Type |
| 5BP | 5.0x5.0mm Size, for DC Lines |

④ Features (1)

| Code | Features | |
|------|----------------|--------------------|
| H | For Automotive | Powertrain, Safety |

⑤ Impedance

Expressed by three figures. The unit is ohm (Ω). The first and second figures are significant digits, and the third figure expresses the number of zeros that follow the two figures.

⑥ Rated Current

Expressed by three figures. The unit is ampere (A). The first and second figures are significant digits, and the third figure expresses the number of zeros that follow the two figures. A decimal point is expressed by the capital letter "R." In this case, all figures are significant digits.

⑦ Features (2)

| Code | Features |
|------|------------------------|
| P | Expressed by a letter. |
| S | |

⑧ Lead Dimensions

| Code | Lead Dimensions |
|------|------------------------|
| N | No Lead Terminal (SMD) |

⑨ Packaging

| Code | Packaging |
|------|--|
| B | Bulk |
| L | Embossed Taping (ϕ 178mm/ ϕ 180mm Reel) |
| K | Embossed Taping (ϕ 330mm Reel) |

Series Lineup

DLM/DLP/DLW/NFP

Common Mode Choke Coil/Common Mode Noise Filter

| Type | Size Code in inches (mm) | Thickness (mm) | Part Number | Common Mode Impedance (at 100MHz) | Rated Current | |
|---|--|----------------|-----------------------------------|-----------------------------------|---------------|-------|
| Multilayer Type Limited for differential signal interface line | 025020 (0605) | 0.3 | DLM0QSB120HY2 <small>p202</small> | 12Ω±5Ω | 150mA | |
| | | 0.3 | DLM0QSB350HY2 <small>p202</small> | 35Ω±30% | 120mA | |
| | | 0.3 | DLM0QSN500HY2 <small>p202</small> | 50Ω±35% | 100mA | |
| | | 0.3 | DLM0QSN650HY2 <small>p202</small> | 65Ω±35% | 100mA | |
| | | 0.3 | DLM0QSN900HY2 <small>p202</small> | 90Ω±25% | 50mA | |
| | 03025 (0806) | 0.45 | DLM0NSB120HY2 <small>p203</small> | 12Ω±5Ω | 160mA | |
| | | 0.45 | DLM0NSB280HY2 <small>p203</small> | 28Ω±30% | 130mA | |
| | | 0.45 | DLM0NSN500HY2 <small>p203</small> | 50Ω±25% | 100mA | |
| | | 0.45 | DLM0NSN900HY2 <small>p203</small> | 90Ω±25% | 100mA | |
| | Multilayer Type for Audio Lines | 0504 (1210) | 0.5 | DLM11GN601SD2 <small>p205</small> | 600Ω±25% | 100mA |
| Multilayer Type for Differential Signal Lines | 0.5 | | DLM11SN450HY2 <small>p206</small> | 45Ω±25% | 100mA | |
| | 0.5 | | DLM11SN900HY2 <small>p206</small> | 90Ω±25% | 100mA | |
| Film Type for Differential Signal Lines | 025020 (0605) | 0.3 | DLP0QSA070HL2 <small>p207</small> | 7Ω±2Ω | 100mA | |
| | | 0.3 | DLP0QSA150HL2 <small>p207</small> | 15Ω±5Ω | 100mA | |
| | | 0.3 | DLP0QSA350HL2 <small>p207</small> | 35Ω±10Ω | 100mA | |
| | 03025 (0806) | 0.45 | DLP0NSN350HL2 <small>p208</small> | 35Ω±10Ω | 100mA | |
| | | 0.45 | DLP0NSN670HL2 <small>p208</small> | 67Ω±20% | 110mA | |
| | | 0.45 | DLP0NSN900HL2 <small>p208</small> | 90Ω±20% | 100mA | |
| | | 0.45 | DLP0NSN121HL2 <small>p208</small> | 120Ω±20% | 90mA | |
| | | 0.45 | DLP0NSA070HL2 <small>p208</small> | 7Ω±2Ω | 100mA | |
| | | 0.45 | DLP0NSA150HL2 <small>p208</small> | 15Ω±5Ω | 100mA | |
| | | 0.45 | DLP0NSC280HL2 <small>p208</small> | 28Ω±20% | 100mA | |
| | | 0.45 | DLP0NSC900HL2 <small>p208</small> | 90Ω±35% | 75mA | |
| | | 0504 (1210) | 0.5 | DLP11RB150UL2 <small>p210</small> | 15Ω±5Ω | 100mA |
| | 0.5 | | DLP11RB400UL2 <small>p210</small> | 40Ω±10Ω | 100mA | |
| | 0.5 | | DLP11RN450UL2 <small>p210</small> | 45Ω±25% | 100mA | |
| | 0.82 | | DLP11SN900HL2 <small>p212</small> | 90Ω±20% | 150mA | |
| | 0.82 | | DLP11SN201HL2 <small>p212</small> | 200Ω±20% | 110mA | |
| | 0.82 | | DLP11SN241HL2 <small>p212</small> | 240Ω±20% | 100mA | |
| | 0.82 | | DLP11SN281HL2 <small>p212</small> | 280Ω±20% | 90mA | |
| | 0.82 | | DLP11SN331HL2 <small>p212</small> | 330Ω±20% | 80mA | |
| | 0.82 | | DLP11SN670SL2 <small>p212</small> | 67Ω±20% | 180mA | |
| | 0.82 | | DLP11SN121SL2 <small>p212</small> | 120Ω±20% | 140mA | |
| | 0.82 | | DLP11SN161SL2 <small>p212</small> | 160Ω±20% | 120mA | |
| | 0.82 | | DLP11SA350HL2 <small>p212</small> | 35Ω±20% | 170mA | |
| | 0.82 | | DLP11SA670HL2 <small>p212</small> | 67Ω±20% | 150mA | |
| | 0.82 | | DLP11SA900HL2 <small>p212</small> | 90Ω±20% | 150mA | |
| | 1206 (3216) | | 0.3 | DLP11TB800UL2 <small>p214</small> | 80Ω±25% | 100mA |
| | | 1.15 | DLP31SN121ML2 <small>p215</small> | 120Ω±20% | 100mA | |
| | | 1.15 | DLP31SN221ML2 <small>p215</small> | 220Ω±20% | 100mA | |
| | Film Array Type for Differential Signal Lines | 05025 (1506) | 1.15 | DLP31SN551ML2 <small>p215</small> | 550Ω±20% | 100mA |
| | | | 0.45 | DLP1NDN350HL4 <small>p216</small> | 35Ω±20% | 100mA |
| 0.45 | | | DLP1NDN670HL4 <small>p216</small> | 67Ω±20% | 80mA | |
| 0804 (2010) | | 0.45 | DLP1NDN900HL4 <small>p216</small> | 90Ω±20% | 60mA | |
| | | 0.82 | DLP2ADN670HL4 <small>p217</small> | 67Ω±20% | 140mA | |
| | | 0.82 | DLP2ADN900HL4 <small>p217</small> | 90Ω±20% | 130mA | |
| | | 0.82 | DLP2ADN121HL4 <small>p217</small> | 120Ω±20% | 120mA | |
| | | 0.82 | DLP2ADN161HL4 <small>p217</small> | 160Ω±20% | 100mA | |
| | | 0.82 | DLP2ADN201HL4 <small>p217</small> | 200Ω±20% | 90mA | |
| 0.82 | DLP2ADN241HL4 <small>p217</small> | 240Ω±20% | 80mA | | | |
| 0.82 | DLP2ADN281HL4 <small>p217</small> | 280Ω±20% | 80mA | | | |

Continued on the following page. ↗

| Type | Size Code in inches (mm) | Thickness (mm) | Part Number | Common Mode Impedance (at 100MHz) | Rated Current |
|--|--------------------------|--------------------|--------------------|-----------------------------------|---------------|
| Film Array Type for Differential Signal Lines | 0804 (2010) | 0.82 | DLP2ADA350HL4 p217 | 35Ω±20% | 150mA |
| | | 0.82 | DLP2ADA670HL4 p217 | 67Ω±20% | 130mA |
| | | 0.82 | DLP2ADA900HL4 p217 | 90Ω±20% | 120mA |
| | 1206 (3216) | 1.15 | DLP31DN900ML4 p219 | 90Ω±20% | 160mA |
| | | 1.15 | DLP31DN131ML4 p219 | 130Ω±20% | 120mA |
| | | 1.15 | DLP31DN201ML4 p219 | 200Ω±20% | 100mA |
| | | 1.15 | DLP31DN321ML4 p219 | 320Ω±20% | 80mA |
| Wire Wound Type for Differential Signal Lines | 0805 (2012) | 0.9 | DLW21HN670SQ2 p220 | 67Ω±25% | 330mA |
| | | 0.9 | DLW21HN900SQ2 p220 | 90Ω±25% | 330mA |
| | | 0.9 | DLW21HN121SQ2 p220 | 120Ω±25% | 280mA |
| | | 0.9 | DLW21HN181SQ2 p220 | 180Ω±25% | 250mA |
| | | 0.9 | DLW21HN670HQ2 p220 | 67Ω±25% | 240mA |
| | | 0.9 | DLW21HN900HQ2 p220 | 90Ω±25% | 220mA |
| | | 0.9 | DLW21HN121HQ2 p220 | 120Ω±25% | 200mA |
| | | 1.2 | DLW21SN670SQ2 p222 | 67Ω±25% | 400mA |
| | | 1.2 | DLW21SN900SQ2 p222 | 90Ω±25% | 330mA |
| | | 1.2 | DLW21SN121SQ2 p222 | 120Ω±25% | 370mA |
| | | 1.2 | DLW21SN181SQ2 p222 | 180Ω±25% | 330mA |
| | | 1.2 | DLW21SN261SQ2 p222 | 260Ω±25% | 300mA |
| | | 1.2 | DLW21SN371SQ2 p222 | 370Ω±25% | 280mA |
| | | 1.2 | DLW21SN501SK2 p222 | 500Ω±25% | 250mA |
| | 1.2 | DLW21SN921SK2 p222 | 920Ω±25% | 160mA | |
| | 1.2 | DLW21SN670HQ2 p222 | 67Ω±25% | 320mA | |
| | 1.2 | DLW21SN900HQ2 p222 | 90Ω±25% | 280mA | |
| | 1.2 | DLW21SN121HQ2 p222 | 120Ω±25% | 280mA | |
| | 1.2 | DLW21SN211XK2 p222 | 210Ω±25% | 360mA | |
| | 1.2 | DLW21SN181XQ2 p222 | 180Ω±25% | 240mA | |
| | 1.2 | DLW21SN261XQ2 p222 | 260Ω±25% | 220mA | |
| | 1.2 | DLW21SN491XQ2 p222 | 490Ω±25% | 190mA | |
| | 1.2 | DLW21SR670HQ2 p222 | 67Ω±25% | 400mA | |
| | 1206 (3216) | 1.9 | DLW31SN900SQ2 p225 | 90Ω±25% | 370mA |
| | | 1.9 | DLW31SN161SQ2 p225 | 160Ω±25% | 340mA |
| | | 1.9 | DLW31SN261SQ2 p225 | 260Ω±25% | 310mA |
| 1.9 | | DLW31SN601SQ2 p225 | 600Ω±25% | 260mA | |
| 1.9 | | DLW31SN102SQ2 p225 | 1000Ω±25% | 230mA | |
| 1.9 | | DLW31SN222SQ2 p225 | 2200Ω±25% | 200mA | |
| Film Type for Differential Signal Lines | 025020 (0605) | 0.3 | NFP0QHB242HS2 p226 | - | 100mA |
| | | 0.3 | NFP0QHB372HS2 p226 | - | 100mA |
| | | 0.3 | NFP0QHB542HS2 p226 | - | 100mA |
| | | 0.3 | NFP0QSB132HL2 p226 | 90Ω (Typ.) | 100mA |
| Wire Wound Type for Power Lines | 1515 (4040) | 1.4 | DLW44SM101SK2 p228 | 100Ω (Typ.) | 3.1A |
| | | 1.4 | DLW44SM251SK2 p228 | 250Ω (Typ.) | 2.6A |
| | | 1.4 | DLW44SM401SK2 p228 | 400Ω (Typ.) | 2.1A |
| | | 1.4 | DLW44SM851SK2 p228 | 850Ω (Typ.) | 1.9A |
| | | 1.4 | DLW44SM172SK2 p228 | 1700Ω (Typ.) | 1.5A |
| | | 1.4 | DLW44SM302SK2 p228 | 2200Ω (Typ.) | 1.1A |
| | | 1.4 | DLW44SM242SK2 p228 | 2400Ω (Typ.) | 1.4A |
| Wire Wound Type for Power Lines and Signal Lines | 2014 (5036) | 4.3 | DLW5AHN402SQ2 p229 | 4000Ω (Typ.) | 200mA |
| | 2020 (5050) | 4.5 | DLW5BSM191SQ2 p229 | 190Ω (Typ.) | 5A |
| | | 4.5 | DLW5BSM351SQ2 p229 | 350Ω (Typ.) | 2A |

Continued on the following page. ↗

| Type | Size Code in inches (mm) | Thickness (mm) | Part Number | Common Mode Impedance (at 100MHz) | Rated Current |
|---|-----------------------------|-----------------------------------|-----------------------------------|--------------------------------------|------------------|
| Wire Wound Type for Power Lines and Signal Lines | 2020 (5050) | 4.5 | DLW5BSM102SQ2 <small>p229</small> | 1000Ω (Typ.) | 1.5A |
| | | 4.5 | DLW5BSM152SQ2 <small>p229</small> | 1500Ω (Typ.) | 1A |
| | | 4.5 | DLW5BSM302SQ2 <small>p229</small> | 3000Ω (Typ.) | 500mA |
| | 2014 (5036) | 2.2 | DLW5ATN111SQ2 <small>p231</small> | 110Ω (Typ.) | 5A |
| | | 2.2 | DLW5ATN401SQ2 <small>p231</small> | 400Ω (Typ.) | 2A |
| | | 2.2 | DLW5ATN501SQ2 <small>p231</small> | 500Ω (Typ.) | 1.5A |
| | | 2.2 | DLW5ATN851SQ2 <small>p231</small> | 850Ω (Typ.) | 1.5A |
| | | 2.2 | DLW5ATN272SQ2 <small>p231</small> | 2700Ω (Typ.) | 1A |
| | | 2.2 | DLW5ATN500MQ2 <small>p233</small> | 50Ω (Typ.) | 6A |
| | | 2.2 | DLW5ATN151MQ2 <small>p233</small> | 150Ω (Typ.) | 5A |
| | | 2.2 | DLW5ATN331MQ2 <small>p233</small> | 330Ω (Typ.) | 4A |
| | | 2.2 | DLW5ATN501MQ2 <small>p233</small> | 500Ω (Typ.) | 2.5A |
| | | 2.2 | DLW5ATN112MQ2 <small>p233</small> | 1100Ω (Typ.) | 2A |
| | | 2.2 | DLW5ATN111TQ2 <small>p234</small> | 110Ω (Typ.) | 5A |
| | | 2.2 | DLW5ATN231TQ2 <small>p234</small> | 230Ω (Typ.) | 4A |
| | | 2.2 | DLW5ATN401TQ2 <small>p234</small> | 400Ω (Typ.) | 2.5A |
| | | 2.2 | DLW5ATN501TQ2 <small>p234</small> | 500Ω (Typ.) | 2A |
| | | 2020 (5050) | 4.5 | DLW5BSM501TQ2 <small>p235</small> | 500Ω (Typ.) |
| | 4.5 | | DLW5BSM601TQ2 <small>p235</small> | 600Ω (Typ.) | 1.4A |
| | 4.5 | | DLW5BSM801TQ2 <small>p235</small> | 800Ω (Typ.) | 2A |
| | 2.35 | | DLW5BTM101SQ2 <small>p236</small> | 100Ω (Typ.) | 6A |
| | 2.35 | | DLW5BTM251SQ2 <small>p236</small> | 250Ω (Typ.) | 5A |
| | 2.35 | | DLW5BTM501SQ2 <small>p236</small> | 500Ω (Typ.) | 4A |
| | 2.35 | | DLW5BTM102SQ2 <small>p236</small> | 1000Ω (Typ.) | 2A |
| | 2.35 | | DLW5BTM142SQ2 <small>p236</small> | 1400Ω (Typ.) | 1.5A |
| | 2.35 | | DLW5BTM101TQ2 <small>p237</small> | 100Ω (Typ.) | 6A |
| | 2.35 | | DLW5BTM251TQ2 <small>p237</small> | 250Ω (Typ.) | 5A |
| | 2.35 | | DLW5BTM501TQ2 <small>p237</small> | 500Ω (Typ.) | 4A |
| | 2.35 | | DLW5BTM102TQ2 <small>p237</small> | 1000Ω (Typ.) | 2.5A |
| | 2.35 | DLW5BTM142TQ2 <small>p237</small> | 1400Ω (Typ.) | 2A | |

Chip Ferrite Bead

Application Specified Noise Filter

Chip EMIFIL®

Common Mode Choke Coil
 Common Mode Noise Filter

Block Type EMIFIL®

EMC Absorber

PLT

Large Current Common Mode Choke Coil for Automotive Available

| Size Code in inches (mm) | Thickness (mm) | Part Number | Common Mode Impedance (at 10MHz) | Rated Current |
|-----------------------------|-------------------|--|-------------------------------------|---------------|
| 2020 (5050) | 5.0 | PLT5BPH1015R6SN <small>p238</small> | 100Ω (Typ.) | 5.6A |
| | 5.0 | PLT5BPH2014R4SN <small>p238</small> | 200Ω (Typ.) | 4.4A |
| | 5.0 | PLT5BPH3013R7SN <small>p238</small> | 300Ω (Typ.) | 3.7A |
| | 5.0 | PLT5BPH5013R1SN <small>p238</small> | 500Ω (Typ.) | 3.1A |
| (12.9X6.6) | 9.4 | PLT10HH450180PN <small>p239</small> | 45Ω (Typ.) | 18A |
| | 9.4 | PLT10HH101150PN <small>p239</small> | 100Ω (Typ.) | 15A |
| | 9.4 | PLT10HH401100PN <small>p239</small> | 400Ω (Typ.) | 10A |
| | 9.4 | PLT10HH501100PN <small>p239</small> | 500Ω (Typ.) | 10A |
| | 9.4 | PLT10HH9016R0PN <small>p239</small> | 900Ω (Typ.) | 6A |
| | 9.4 | PLT10HH1026R0PN <small>p239</small> | 1000Ω (Typ.) | 6A |

Chip Ferrite Bead

Application Specified Noise Filter

Chip EMIFIL®

Common Mode Choke Coil
 Common Mode Noise Filter

Block Type EMIFIL®

EMC Absorber

Common mode choke coil/Common mode noise filter

DLM0QS Series 025020/0605(inch/mm)

Use for differential signal interface line.

Appearance/Dimensions

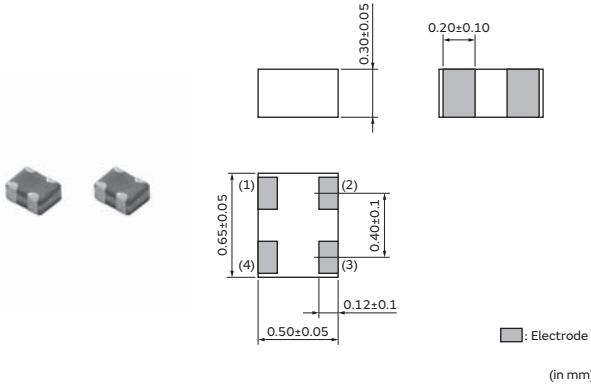

Packaging

| Code | Packaging | Minimum Quantity |
|------|-------------------|------------------|
| D | ø180mm Paper Tape | 15000 |
| B | Bulk(Bag) | 500 |

Equivalent Circuit

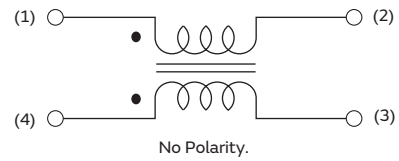

Rated Value (□: packaging code)

| Part Number | Common Mode Impedance at 100MHz | Cutoff Frequency | Rated Current | Rated Voltage | Insulation Resistance (Min.) | Withstanding Voltage | DC Resistance |
|----------------|---------------------------------|------------------|---------------|---------------|------------------------------|----------------------|---------------|
| DLM0QSB120HY2□ | 12Ω±5% | 8.0GHz (Typ.) | 150mA | 5Vdc | 10MΩ | 12.5Vdc | 1.6Ω±25% |
| DLM0QSB350HY2□ | 35Ω±30% | 8.0GHz (Typ.) | 120mA | 5Vdc | 10MΩ | 12.5Vdc | 2.3Ω±25% |
| DLM0QSN500HY2□ | 50Ω±35% | 4.0GHz (Typ.) | 100mA | 5Vdc | 10MΩ | 12.5Vdc | 3.6Ω±25% |
| DLM0QSN650HY2□ | 65Ω±35% | 4.0GHz (Typ.) | 100mA | 5Vdc | 10MΩ | 12.5Vdc | 3.6Ω±25% |
| DLM0QSN900HY2□ | 90Ω±25% | 2.0GHz (Typ.) | 50mA | 5Vdc | 10MΩ | 12.5Vdc | 4.0Ω±25% |

Operating Temp. Range: -40°C to 85°C

Z-f Characteristics: DLM0QS_HY2 Series

Differential mode transmission characteristics: DLM0QS_HY2series

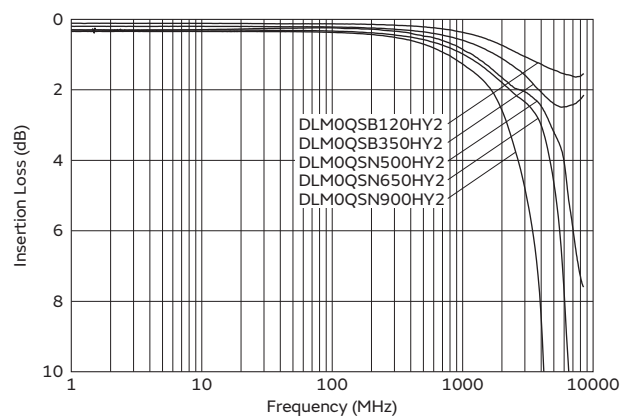
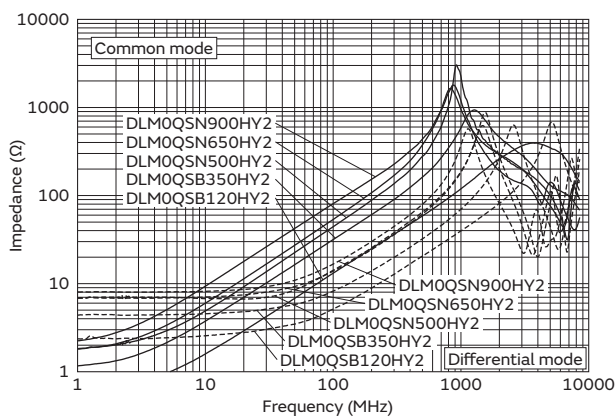

Common mode choke coil/Common mode noise filter

DLMONS Series 03025/0806(inch/mm)

Use for differential signal interface line.

Appearance/Dimensions

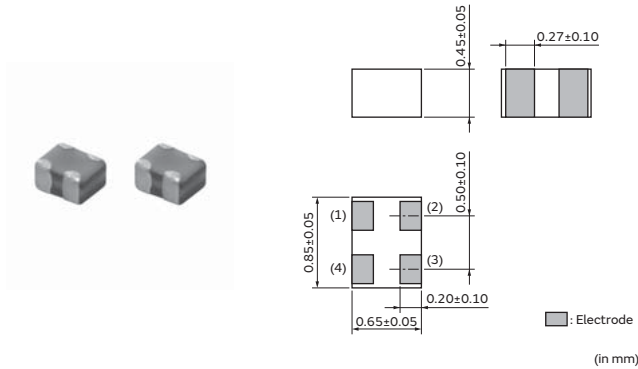

Packaging

| Code | Packaging | Minimum Quantity |
|------|-------------------|------------------|
| D | ø180mm Paper Tape | 10000 |
| B | Bulk(Bag) | 500 |

Equivalent Circuit

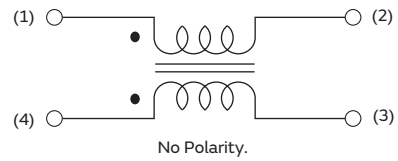

Rated Value (□: packaging code)

| Part Number | Common Mode Impedance at 100MHz | Cutoff Frequency | Rated Current | Rated Voltage | Insulation Resistance (Min.) | Withstanding Voltage | DC Resistance |
|----------------|---------------------------------|------------------|---------------|---------------|------------------------------|----------------------|---------------|
| DLMONSB120HY2□ | 12Ω±5Ω | 8.0GHz (Typ.) | 160mA | 5Vdc | 10MΩ | 12.5Vdc | 1.2Ω±25% |
| DLMONSB280HY2□ | 28Ω±30% | 8.0GHz (Typ.) | 130mA | 5Vdc | 10MΩ | 12.5Vdc | 1.9Ω±25% |
| DLMONSN500HY2□ | 50Ω±25% | 5.0GHz (Typ.) | 100mA | 5Vdc | 10MΩ | 12.5Vdc | 2.7Ω±25% |
| DLMONSN900HY2□ | 90Ω±25% | 2.0GHz (Typ.) | 100mA | 5Vdc | 10MΩ | 12.5Vdc | 4.0Ω±25% |

Operating Temp. Range: -40°C to 85°C

Z-f Characteristics: DLMONSB_HY2 Series

Differential mode transmission characteristics: DLMONSB_HY2series

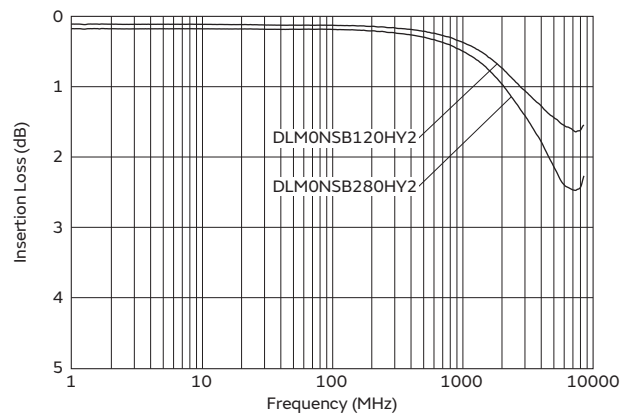
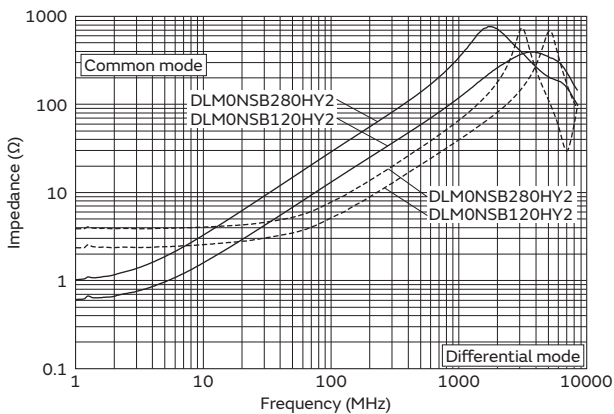

Continued on the following page. ↗

Continued from the preceding page. ↘

Z-f Characteristics: DLM0NSN_HY2 Series

Differential mode transmission characteristics: DLM0NSN_HY2series

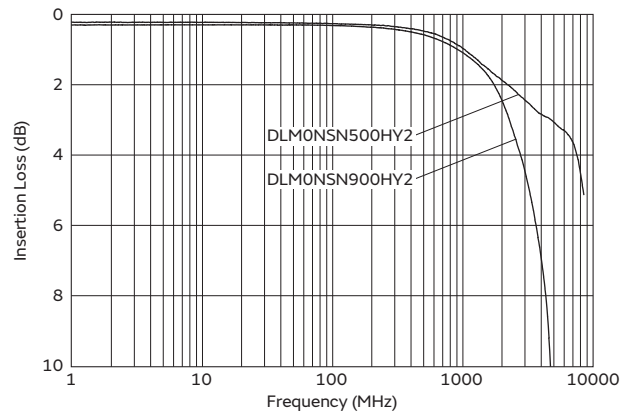
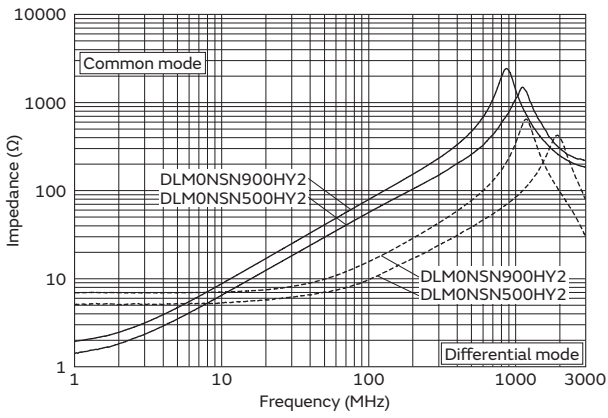

Chip Ferrite Bead

Application Specified Noise Filter

Chip EMIFIL®

Common Mode Choke Coil
 Common Mode Noise Filter

Block Type EMIFIL®

EMC Absorber

Common mode choke coil/Common mode noise filter

DLM11G Series 0504/1210(inch/mm)

Appearance/Dimensions

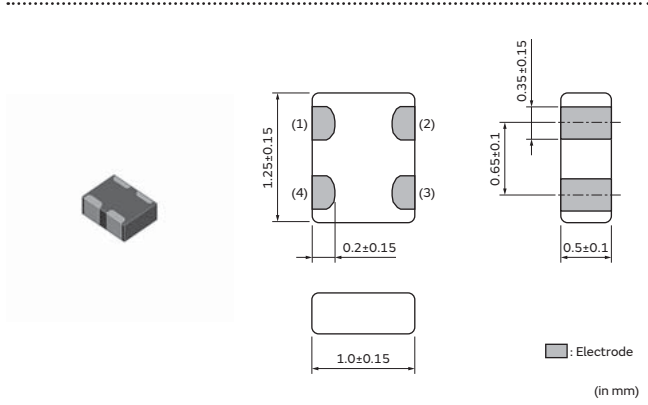

Packaging

| Code | Packaging | Minimum Quantity |
|------|-------------------|------------------|
| D | ø180mm Paper Tape | 10000 |
| B | Bulk(Bag) | 1000 |

Equivalent Circuit

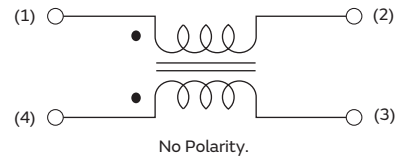

Rated Value (□: packaging code)

| Part Number | Common Mode Impedance at 100MHz | Rated Current | Rated Voltage | Insulation Resistance (Min.) | Withstanding Voltage | DC Resistance | Operating Temp. Range |
|----------------|---------------------------------|---------------|---------------|------------------------------|----------------------|---------------|-----------------------|
| DLM11GN601SD2□ | 600Ω±25% | 100mA | 5Vdc | 100MΩ | 25Vdc | 0.8Ω max. | -40°C to 85°C |

Z-f Characteristics: DLM11GN_SD2 Series

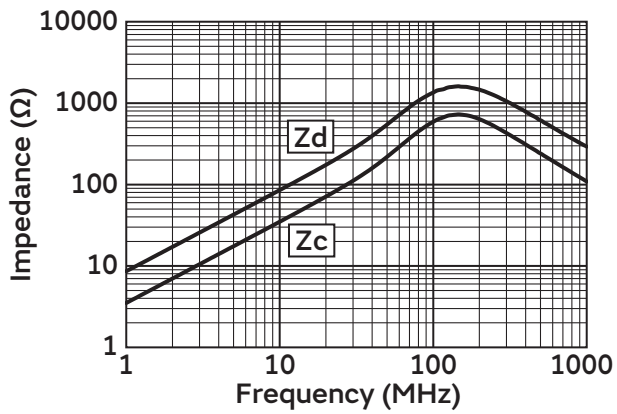

Common mode choke coil/Common mode noise filter

DLM11S Series 0504/1210(inch/mm)

Appearance/Dimensions

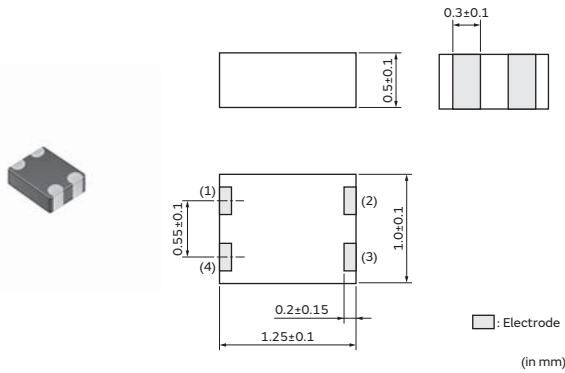

Packaging

| Code | Packaging | Minimum Quantity |
|------|----------------------|------------------|
| L | ø180mm Embossed Tape | 4000 |
| B | Bulk(Bag) | 500 |

Equivalent Circuit

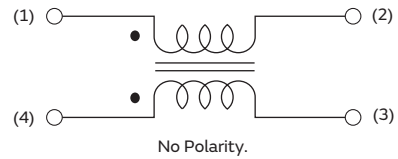

Rated Value (□: packaging code)

| Part Number | Common Mode Impedance at 100MHz | Rated Current | Rated Voltage | Insulation Resistance (Min.) | Withstanding Voltage | DC Resistance |
|----------------|---------------------------------|---------------|---------------|------------------------------|----------------------|---------------|
| DLM11SN450HY2□ | 45Ω±25% | 100mA | 5Vdc | 100MΩ | 12.5Vdc | 0.7Ω±25% |
| DLM11SN900HY2□ | 90Ω±25% | 100mA | 5Vdc | 100MΩ | 12.5Vdc | 1.1Ω±25% |

Operating Temp. Range: -40°C to 85°C

Z-f Characteristics: DLM11SN_HY2 Series

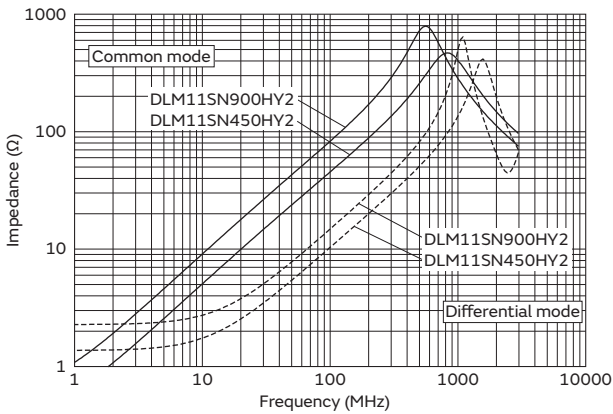

Differential mode transmission characteristics: DLM11SN_HY2series

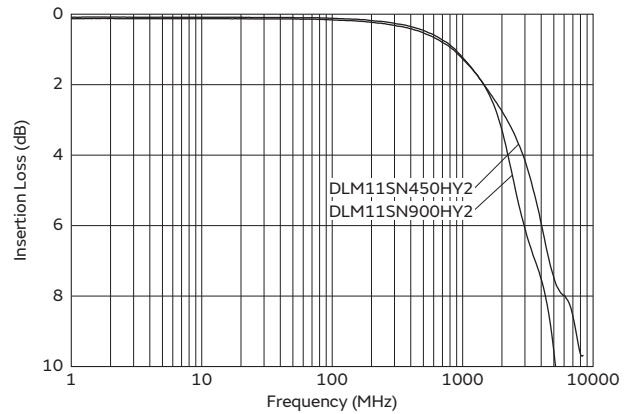

Common mode choke coil/Common mode noise filter

DLPOQS Series 025020/0605(inch/mm)

Appearance/Dimensions

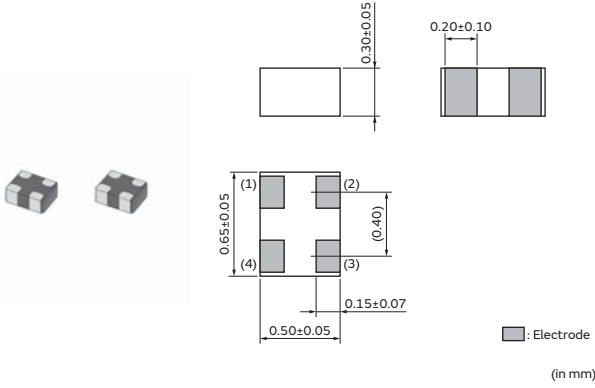

Packaging

| Code | Packaging | Minimum Quantity |
|------|-------------------|------------------|
| D | ø180mm Paper Tape | 15000 |
| B | Bulk(Bag) | 500 |

Equivalent Circuit

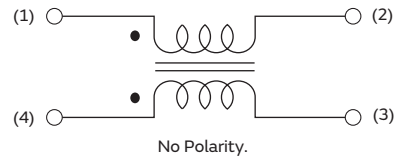

Rated Value (□: packaging code)

| Part Number | Common Mode Impedance at 100MHz | Rated Current | Rated Voltage | Insulation Resistance (Min.) | Withstanding Voltage | DC Resistance |
|----------------|---------------------------------|---------------|---------------|------------------------------|----------------------|---------------|
| DLPOQSA070HL2□ | 7Ω±2Ω | 100mA | 5Vdc | 100MΩ | 12.5Vdc | 0.7Ω±25% |
| DLPOQSA150HL2□ | 15Ω±5Ω | 100mA | 5Vdc | 100MΩ | 12.5Vdc | 0.8Ω±25% |
| DLPOQSA350HL2□ | 35Ω±10Ω | 100mA | 5Vdc | 100MΩ | 12.5Vdc | 2.2Ω±25% |

Operating Temp. Range: -40°C to 85°C

Z-f Characteristics: DLPOQSA_HL2 Series

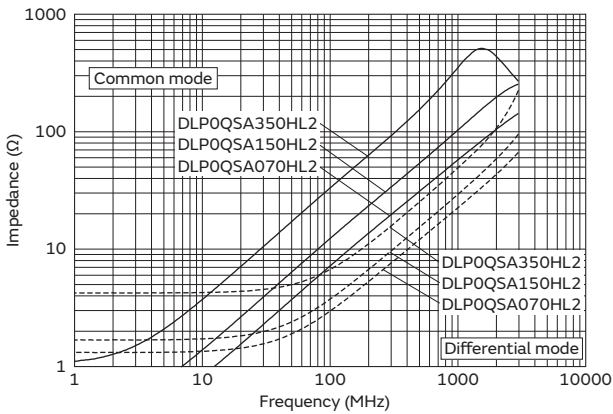

Differential mode transmission characteristics: DLPOQSA_HL2series

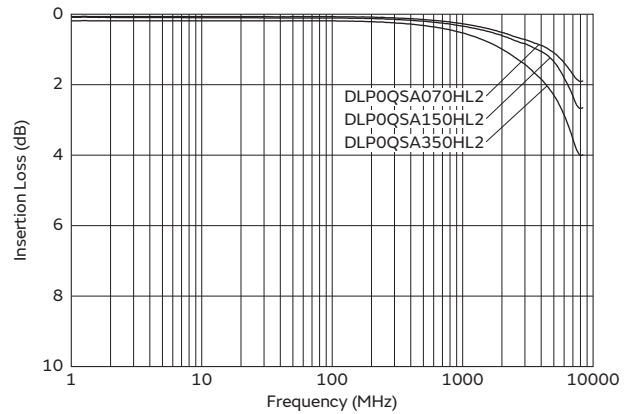

Common mode choke coil/Common mode noise filter

DLPONS Series 03025/0806(inch/mm)

Appearance/Dimensions

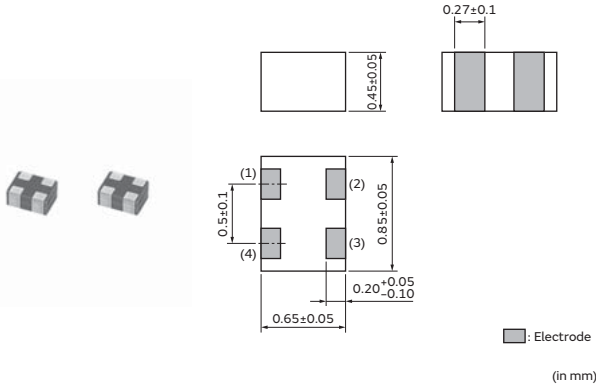

Packaging

| Code | Packaging | Minimum Quantity |
|------|----------------------|------------------|
| L | ø180mm Embossed Tape | 10000 |
| B | Bulk(Bag) | 500 |

Equivalent Circuit

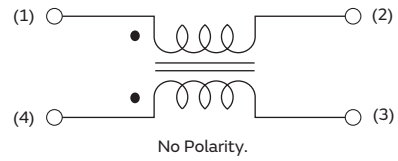

Rated Value (□: packaging code)

| Part Number | Common Mode Impedance at 100MHz | Rated Current | Rated Voltage | Insulation Resistance (Min.) | Withstanding Voltage | DC Resistance |
|----------------|---------------------------------|---------------|---------------|------------------------------|----------------------|---------------|
| DLPONSN350HL2□ | 35Ω±10Ω | 100mA | 5Vdc | 100MΩ | 12.5Vdc | 1.2Ω±25% |
| DLPONSN670HL2□ | 67Ω±20% | 110mA | 5Vdc | 100MΩ | 12.5Vdc | 2.4Ω±25% |
| DLPONSN900HL2□ | 90Ω±20% | 100mA | 5Vdc | 100MΩ | 12.5Vdc | 3.0Ω±25% |
| DLPONSN121HL2□ | 120Ω±20% | 90mA | 5Vdc | 100MΩ | 12.5Vdc | 3.8Ω±25% |
| DLPONSA070HL2□ | 7Ω±2Ω | 100mA | 5Vdc | 100MΩ | 12.5Vdc | 0.6Ω±25% |
| DLPONSA150HL2□ | 15Ω±5Ω | 100mA | 5Vdc | 100MΩ | 12.5Vdc | 0.95Ω±25% |
| DLPONSC280HL2□ | 28Ω±20% | 100mA | 5Vdc | 100MΩ | 12.5Vdc | 1.3Ω±25% |
| DLPONSC900HL2□ | 90Ω±35% | 75mA | 5Vdc | 100MΩ | 12.5Vdc | 4.0Ω±30% |

Operating Temp. Range: -40°C to 85°C

Z-f Characteristics: DLPONSN_HL2 Series

Differential mode transmission characteristics: DLPONSN_HL2series

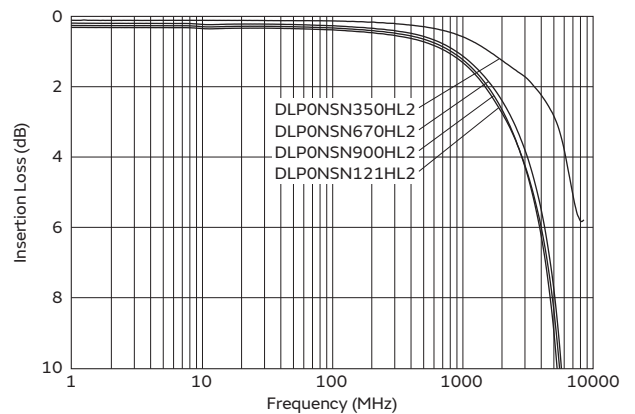
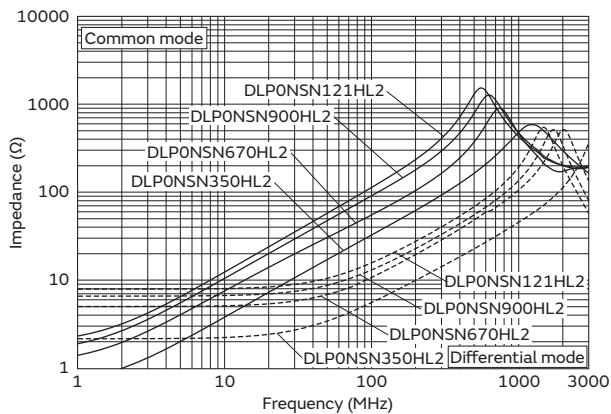

Continued on the following page. ↗

Continued from the preceding page. ↘

Z-f Characteristics: DLPONSA_HL2 Series

Differential mode transmission characteristics: DLPONSA_HL2series

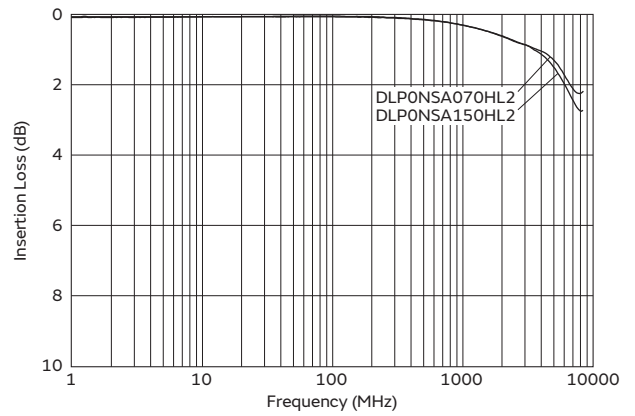
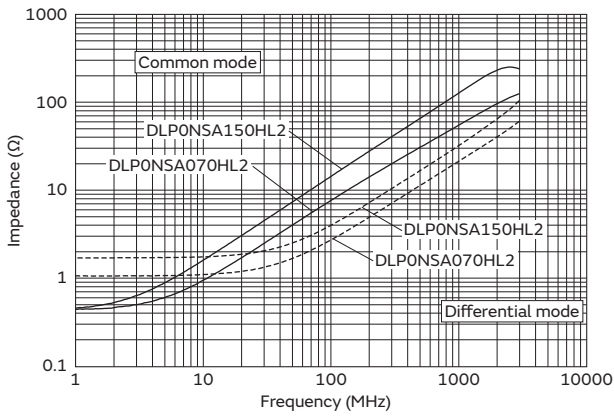

Z-f Characteristics: DLPONSC_HL2 Series

Differential mode transmission characteristics: DLPONSC_HL2series

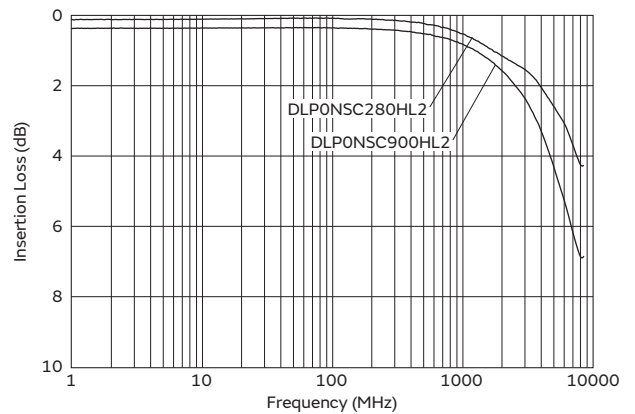
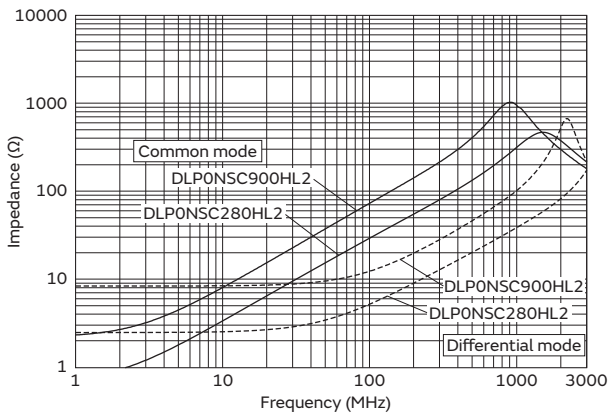

Chip Ferrite Bead

Application Specified Noise Filter

Chip EMIFIL®

Common Mode Choke Coil
 Common Mode Noise Filter

Block Type EMIFIL®

EMC Absorber

Common mode choke coil/Common mode noise filter

DLP11R Series 0504/1210(inch/mm)

Appearance/Dimensions

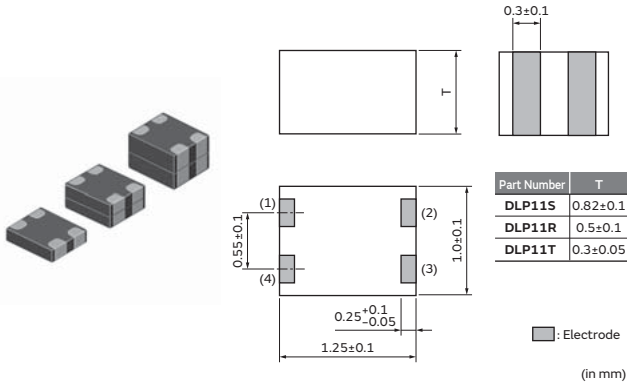

Packaging

| Code | Packaging | Minimum Quantity |
|------|----------------------|------------------|
| L | ø180mm Embossed Tape | 4000 |
| B | Bulk(Bag) | 500 |

Equivalent Circuit

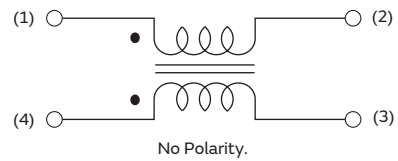

Rated Value (□: packaging code)

| Part Number | Common Mode Impedance at 100MHz | Rated Current | Rated Voltage | Insulation Resistance (Min.) | Withstanding Voltage | DC Resistance |
|----------------|---------------------------------|---------------|---------------|------------------------------|----------------------|---------------|
| DLP11RB150UL2□ | 15Ω±5Ω | 100mA | 5Vdc | 100MΩ | 12.5Vdc | 0.8Ω±25% |
| DLP11RB400UL2□ | 40Ω±10Ω | 100mA | 5Vdc | 100MΩ | 12.5Vdc | 1.3Ω±25% |
| DLP11RN450UL2□ | 45Ω±25% | 100mA | 5Vdc | 100MΩ | 12.5Vdc | 0.8Ω±25% |

Operating Temp. Range: -40°C to 85°C

Z-f Characteristics: DLP11RB_UL2 Series

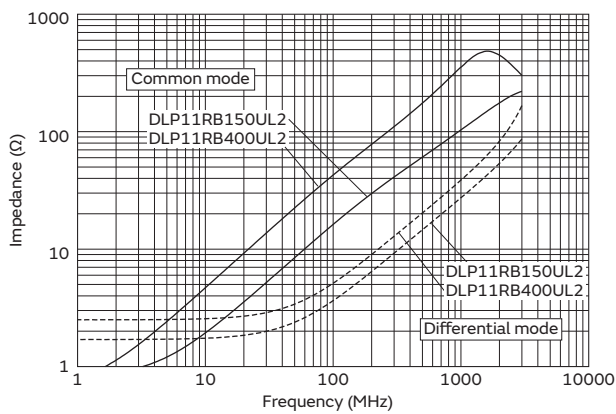

Differential mode transmission characteristics: DLP11RB_UL2series

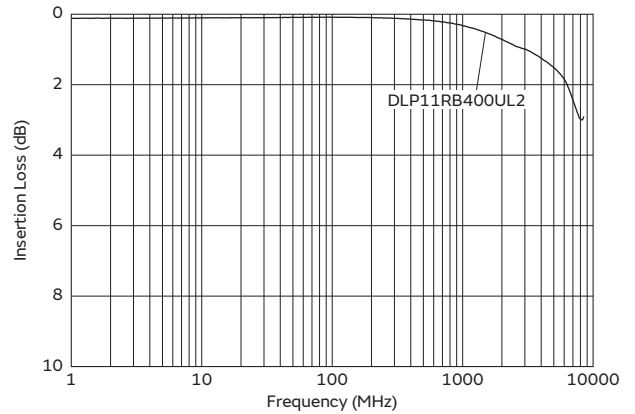

Continued on the following page. ↗

Continued from the preceding page. ↘

Z-f Characteristics: DLP11RN_UL2 Series

Differential mode transmission characteristics: DLP11RN_UL2series

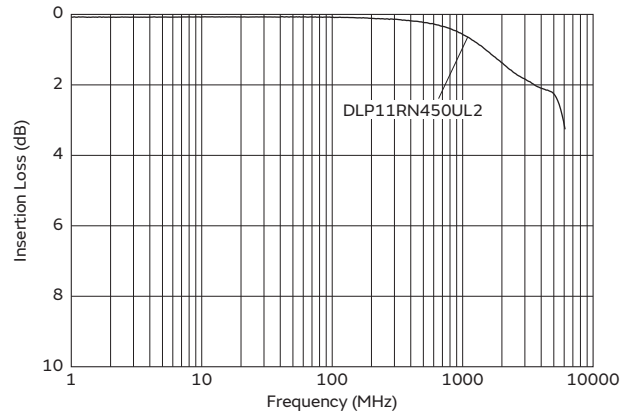
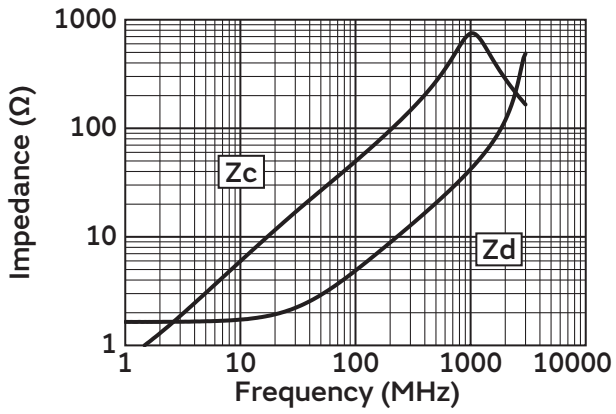

Chip Ferrite Bead

Application Specified Noise Filter

Chip EMIFIL®

Common Mode Choke Coil
 Common Mode Noise Filter

Block Type EMIFIL®

EMC Absorber

Common mode choke coil/Common mode noise filter

DLP11S Series 0504/1210(inch/mm)

Appearance/Dimensions

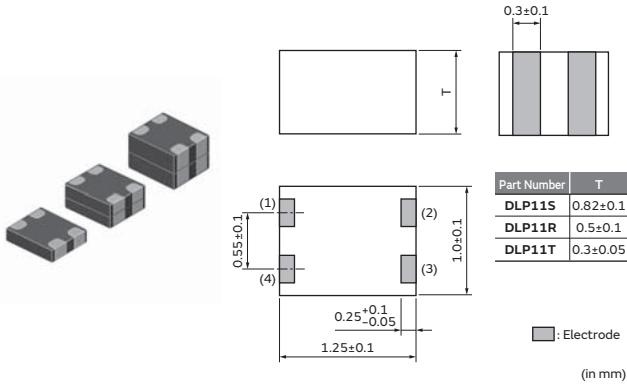

Packaging

| Code | Packaging | Minimum Quantity |
|------|----------------------|------------------|
| L | ø180mm Embossed Tape | 3000 |
| B | Bulk(Bag) | 500 |

Equivalent Circuit

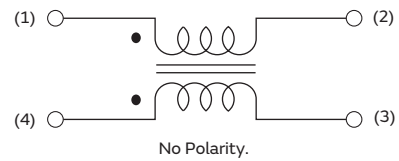

Rated Value (□: packaging code)

| Part Number | Common Mode Impedance at 100MHz | Rated Current | Rated Voltage | Insulation Resistance (Min.) | Withstanding Voltage | DC Resistance |
|----------------|---------------------------------|---------------|---------------|------------------------------|----------------------|---------------|
| DLP11SN900HL2□ | 90Ω±20% | 150mA | 5Vdc | 100MΩ | 12.5Vdc | 1.5Ω±25% |
| DLP11SN201HL2□ | 200Ω±20% | 110mA | 5Vdc | 100MΩ | 12.5Vdc | 3.1Ω±25% |
| DLP11SN241HL2□ | 240Ω±20% | 100mA | 5Vdc | 100MΩ | 12.5Vdc | 3.5Ω±25% |
| DLP11SN281HL2□ | 280Ω±20% | 90mA | 5Vdc | 100MΩ | 12.5Vdc | 4.2Ω±25% |
| DLP11SN331HL2□ | 330Ω±20% | 80mA | 5Vdc | 100MΩ | 12.5Vdc | 4.9Ω±25% |
| DLP11SN670SL2□ | 67Ω±20% | 180mA | 5Vdc | 100MΩ | 12.5Vdc | 1.3Ω±25% |
| DLP11SN121SL2□ | 120Ω±20% | 140mA | 5Vdc | 100MΩ | 12.5Vdc | 2.0Ω±25% |
| DLP11SN161SL2□ | 160Ω±20% | 120mA | 5Vdc | 100MΩ | 12.5Vdc | 2.7Ω±25% |
| DLP11SA350HL2□ | 35Ω±20% | 170mA | 5Vdc | 100MΩ | 12.5Vdc | 0.9Ω±25% |
| DLP11SA670HL2□ | 67Ω±20% | 150mA | 5Vdc | 100MΩ | 12.5Vdc | 1.2Ω±25% |
| DLP11SA900HL2□ | 90Ω±20% | 150mA | 5Vdc | 100MΩ | 12.5Vdc | 1.4Ω±25% |

Operating Temp. Range: -40°C to 85°C

Z-f Characteristics: DLP11SN_HL2/SL2 Series

Differential mode transmission characteristics: DLP11SN_HL2series

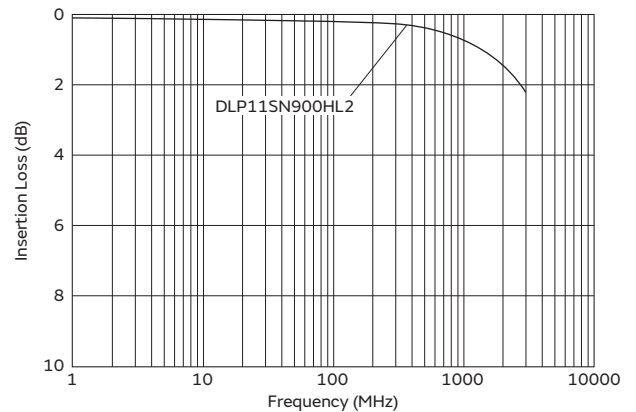
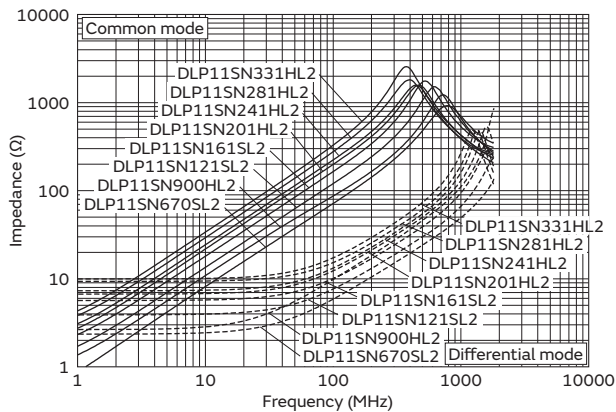

Continued on the following page. ↗

Continued from the preceding page. ↘

Z-f Characteristics: DLP11SA_HL2 Series

Differential mode transmission characteristics: DLP11SA_HL2series

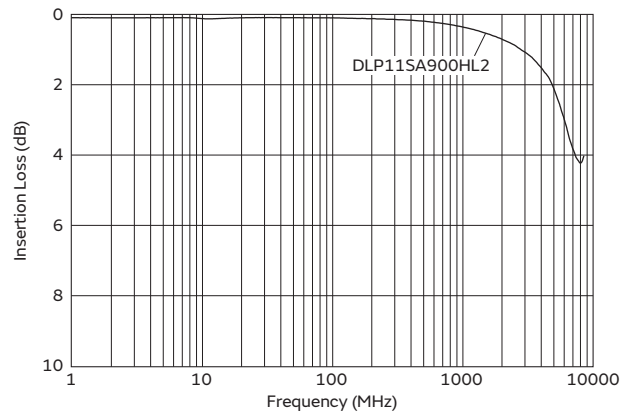
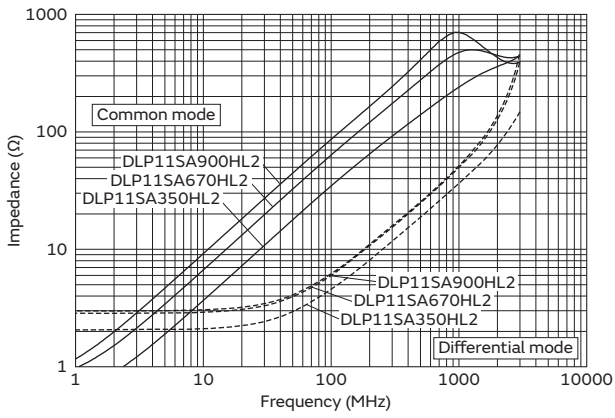

Chip Ferrite Bead

Application Specified Noise Filter

Chip EMIFIL®

Common Mode Choke Coil
 Common Mode Noise Filter

Block Type EMIFIL®

EMC Absorber

Common mode choke coil/Common mode noise filter

DLP11T Series 0504/1210(inch/mm)

Appearance/Dimensions

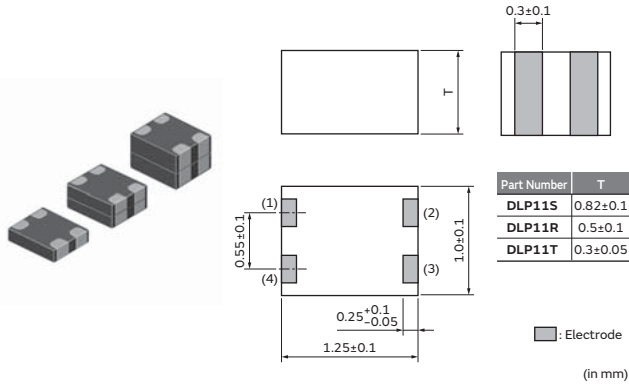

Packaging

| Code | Packaging | Minimum Quantity |
|------|----------------------|------------------|
| L | ø180mm Embossed Tape | 5000 |
| B | Bulk(Bag) | 500 |

Equivalent Circuit

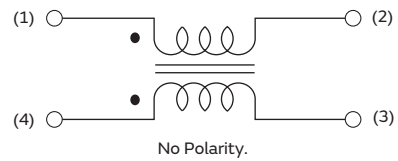

Rated Value (□: packaging code)

| Part Number | Common Mode Impedance at 100MHz | Rated Current | Rated Voltage | Insulation Resistance (Min.) | Withstanding Voltage | DC Resistance | Operating Temp. Range |
|----------------|---------------------------------|---------------|---------------|------------------------------|----------------------|---------------|-----------------------|
| DLP11TB800UL2□ | 80Ω±25% | 100mA | 5Vdc | 100MΩ | 12.5Vdc | 1.5Ω±25% | -40°C to 85°C |

Z-f Characteristics: DLP11TB_UL2 Series

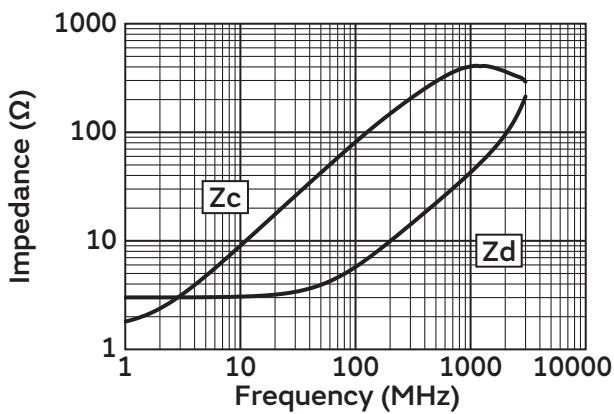

Differential mode transmission characteristics: DLP11TB_UL2series

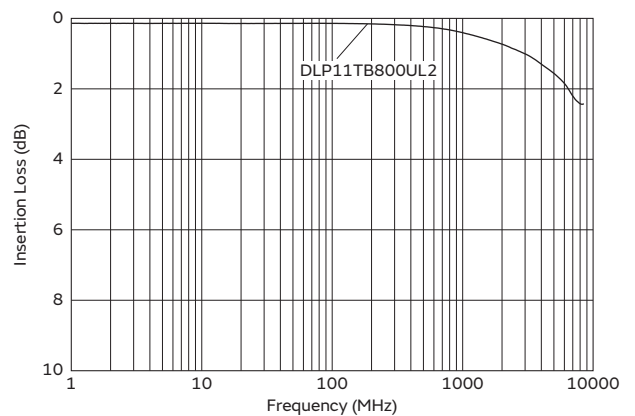

Common mode choke coil/Common mode noise filter

DLP31S Series 1206/3216(inch/mm)

Appearance/Dimensions

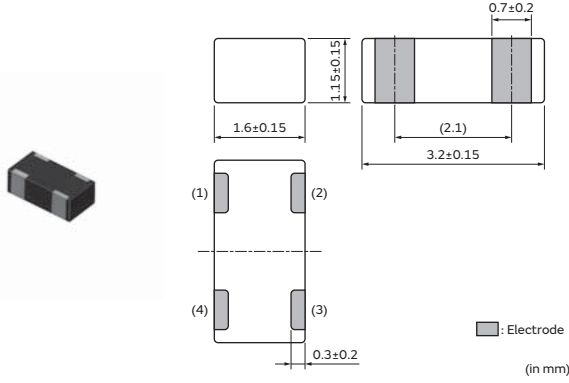

Packaging

| Code | Packaging | Minimum Quantity |
|------|----------------------|------------------|
| L | ø180mm Embossed Tape | 3000 |
| B | Bulk(Bag) | 500 |

Equivalent Circuit

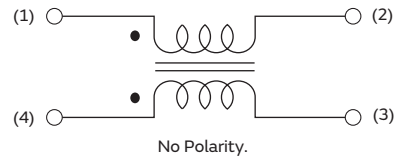

Rated Value (□: packaging code)

| Part Number | Common Mode Impedance at 100MHz | Rated Current | Rated Voltage | Insulation Resistance (Min.) | Withstanding Voltage | DC Resistance |
|----------------|---------------------------------|---------------|---------------|------------------------------|----------------------|---------------|
| DLP31SN121ML2□ | 120Ω±20% | 100mA | 16Vdc | 100MΩ | 40Vdc | 2.0Ω max. |
| DLP31SN221ML2□ | 220Ω±20% | 100mA | 16Vdc | 100MΩ | 40Vdc | 2.5Ω max. |
| DLP31SN551ML2□ | 550Ω±20% | 100mA | 16Vdc | 100MΩ | 40Vdc | 3.6Ω max. |

Operating Temp. Range: -40°C to 85°C

Z-f Characteristics: DLP31SN_ML2 Series

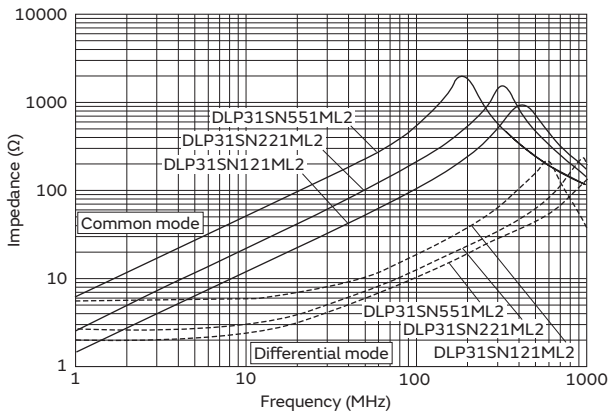

Common mode choke coil/Common mode noise filter

DLP1ND Series 05025/1506(inch/mm)

Appearance/Dimensions

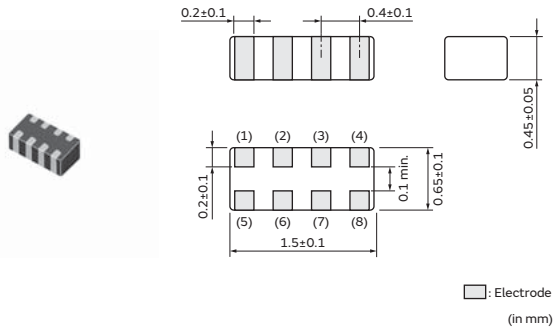

Packaging

| Code | Packaging | Minimum Quantity |
|------|----------------------|------------------|
| L | ø180mm Embossed Tape | 5000 |
| B | Bulk(Bag) | 500 |

Equivalent Circuit

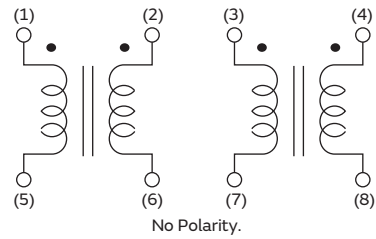

Rated Value (□: packaging code)

| Part Number | Common Mode Impedance at 100MHz | Rated Current | Rated Voltage | Insulation Resistance (Min.) | Withstanding Voltage | DC Resistance |
|----------------|---------------------------------|---------------|---------------|------------------------------|----------------------|---------------|
| DLP1NDN350HL4□ | 35Ω±20% | 100mA | 5Vdc | 100MΩ | 12.5Vdc | 1.8Ω±25% |
| DLP1NDN670HL4□ | 67Ω±20% | 80mA | 5Vdc | 100MΩ | 12.5Vdc | 2.9Ω±25% |
| DLP1NDN900HL4□ | 90Ω±20% | 60mA | 5Vdc | 100MΩ | 12.5Vdc | 3.7Ω±25% |

Operating Temp. Range: -40°C to 85°C

Z-f Characteristics: DLP1NDN_HL4 Series

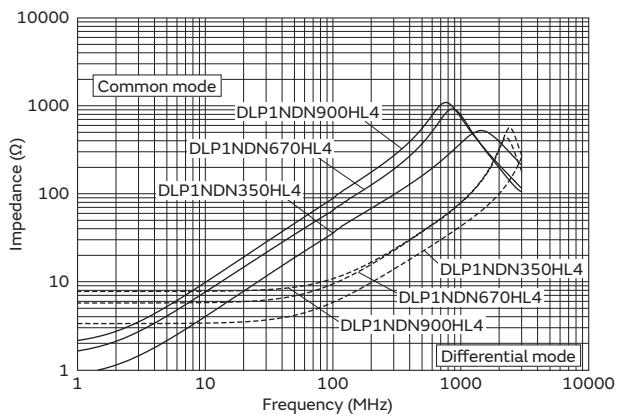

Differential mode transmission characteristics: DLP1NDN_HL4series

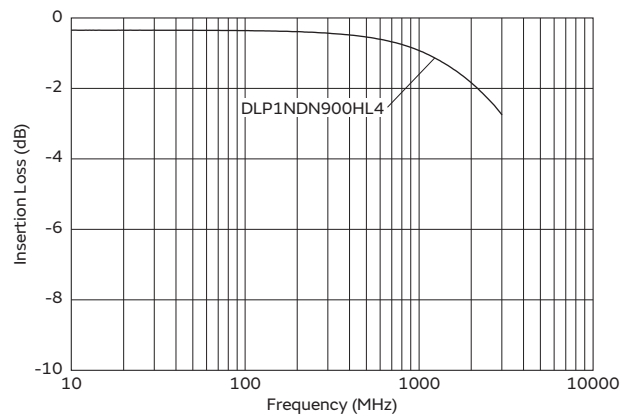

Chip Ferrite Bead

Application Specified Noise Filter

Chip EMIFIL®

Common Mode Choke Coil
 Common Mode Noise Filter

Block Type EMIFIL®

EMC Absorber

Common mode choke coil/Common mode noise filter

DLP2AD Series 0804/2010(inch/mm)

Appearance/Dimensions

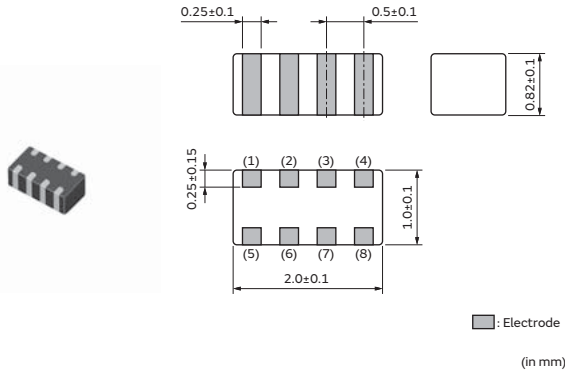

Packaging

| Code | Packaging | Minimum Quantity |
|------|----------------------|------------------|
| L | ø180mm Embossed Tape | 3000 |
| B | Bulk(Bag) | 500 |

Equivalent Circuit

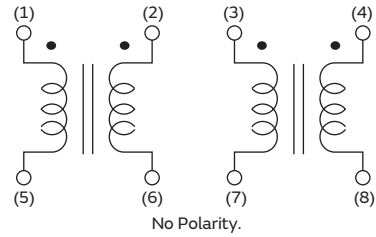

Rated Value (□: packaging code)

| Part Number | Common Mode Impedance at 100MHz | Rated Current | Rated Voltage | Insulation Resistance (Min.) | Withstanding Voltage | DC Resistance |
|----------------|---------------------------------|---------------|---------------|------------------------------|----------------------|---------------|
| DLP2ADN670HL4□ | 67Ω±20% | 140mA | 5Vdc | 100MΩ | 12.5Vdc | 1.3Ω±25% |
| DLP2ADN900HL4□ | 90Ω±20% | 130mA | 5Vdc | 100MΩ | 12.5Vdc | 1.7Ω±25% |
| DLP2ADN121HL4□ | 120Ω±20% | 120mA | 5Vdc | 100MΩ | 12.5Vdc | 2.0Ω±25% |
| DLP2ADN161HL4□ | 160Ω±20% | 100mA | 5Vdc | 100MΩ | 12.5Vdc | 2.5Ω±25% |
| DLP2ADN201HL4□ | 200Ω±20% | 90mA | 5Vdc | 100MΩ | 12.5Vdc | 3.2Ω±25% |
| DLP2ADN241HL4□ | 240Ω±20% | 80mA | 5Vdc | 100MΩ | 12.5Vdc | 3.8Ω±25% |
| DLP2ADN281HL4□ | 280Ω±20% | 80mA | 5Vdc | 100MΩ | 12.5Vdc | 4.6Ω±25% |
| DLP2ADA350HL4□ | 35Ω±20% | 150mA | 5Vdc | 100MΩ | 12.5Vdc | 0.8Ω±25% |
| DLP2ADA670HL4□ | 67Ω±20% | 130mA | 5Vdc | 100MΩ | 12.5Vdc | 1.0Ω±25% |
| DLP2ADA900HL4□ | 90Ω±20% | 120mA | 5Vdc | 100MΩ | 12.5Vdc | 1.4Ω±25% |

Operating Temp. Range: -40°C to 85°C

Z-f Characteristics: DLP2ADN_HL4 Series

Differential mode transmission characteristics: DLP2ADN_HL4series

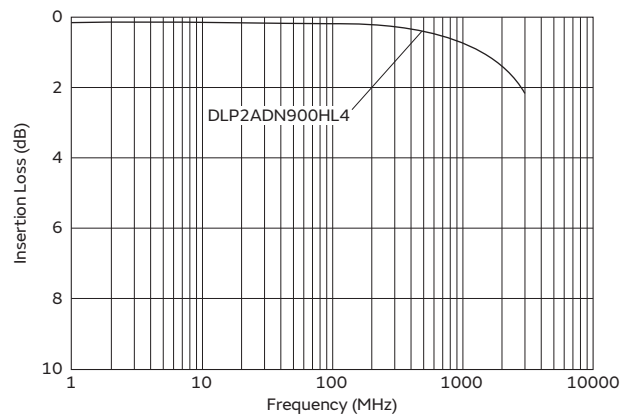
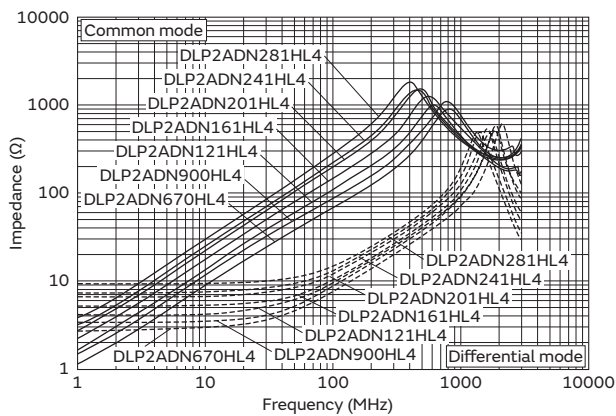

Continued on the following page. ↗

Continued from the preceding page. ↘

Z-f Characteristics: DLP2ADA_HL4 Series

Differential mode transmission characteristics: DLP2ADA_HL4series

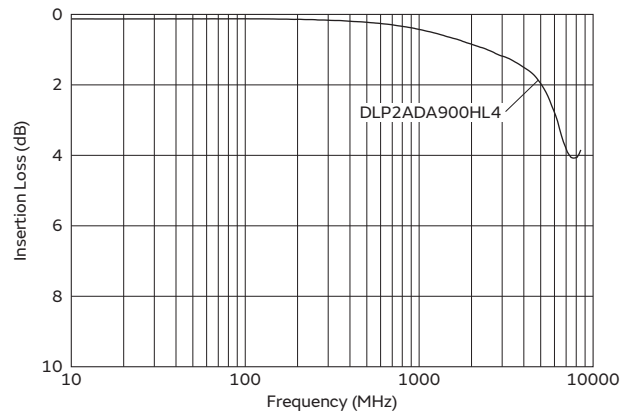
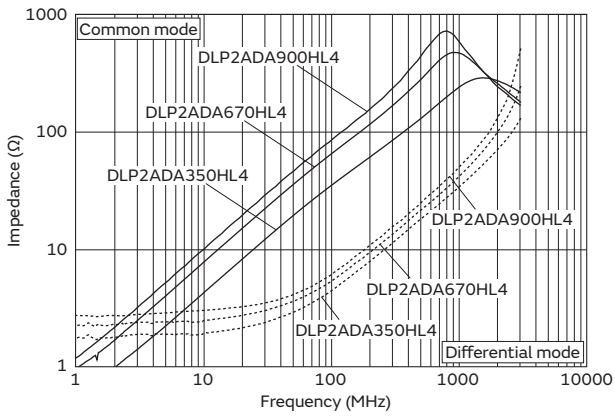

Chip Ferrite Bead

Application Specified Noise Filter

Chip EMIFIL®

Common Mode Choke Coil
 Common Mode Noise Filter

Block Type EMIFIL®

EMC Absorber

Common mode choke coil/Common mode noise filter

DLP31D Series 1206/3216(inch/mm)

Appearance/Dimensions

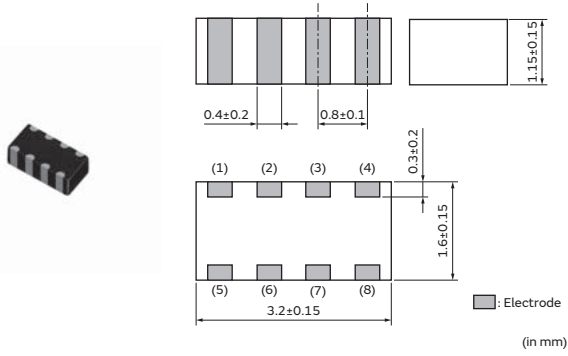

Packaging

| Code | Packaging | Minimum Quantity |
|------|----------------------|------------------|
| L | ø180mm Embossed Tape | 3000 |
| B | Bulk(Bag) | 500 |

Equivalent Circuit

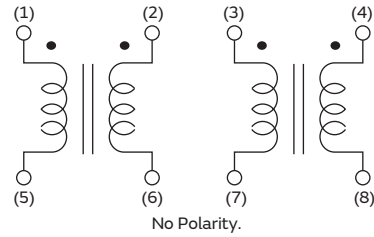

Rated Value (□: packaging code)

| Part Number | Common Mode Impedance at 100MHz | Rated Current | Rated Voltage | Insulation Resistance (Min.) | Withstanding Voltage | DC Resistance |
|----------------|---------------------------------|---------------|---------------|------------------------------|----------------------|---------------|
| DLP31DN900ML4□ | 90Ω±20% | 160mA | 10Vdc | 100MΩ | 25Vdc | 1.1Ω max. |
| DLP31DN131ML4□ | 130Ω±20% | 120mA | 10Vdc | 100MΩ | 25Vdc | 1.6Ω max. |
| DLP31DN201ML4□ | 200Ω±20% | 100mA | 10Vdc | 100MΩ | 25Vdc | 2.2Ω max. |
| DLP31DN321ML4□ | 320Ω±20% | 80mA | 10Vdc | 100MΩ | 25Vdc | 3.5Ω max. |
| DLP31DN441ML4□ | 440Ω±20% | 70mA | 10Vdc | 100MΩ | 25Vdc | 4.3Ω max. |

Operating Temp. Range: -40°C to 85°C

Z-f Characteristics: DLP31DN_ML4 Series

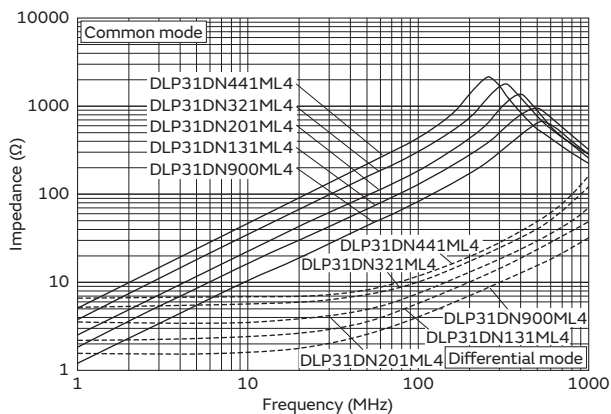

Common mode choke coil/Common mode noise filter

DLW21H Series 0805/2012(inch/mm)

Appearance/Dimensions

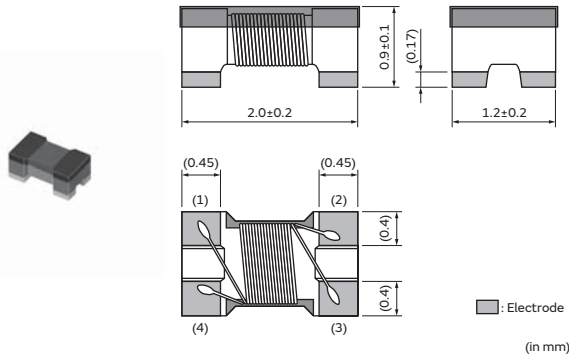

Packaging

| Code | Packaging | Minimum Quantity |
|------|----------------------|------------------|
| L | ø180mm Embossed Tape | 3000 |
| B | Bulk(Bag) | 500 |

Equivalent Circuit

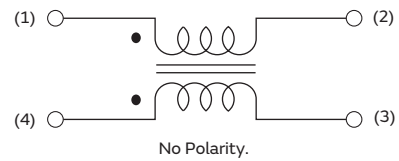

Rated Value (□: packaging code)

| Part Number | Common Mode Impedance at 100MHz | Rated Current | Rated Voltage | Insulation Resistance (Min.) | Withstanding Voltage | DC Resistance |
|----------------|---------------------------------|---------------|---------------|------------------------------|----------------------|---------------|
| DLW21HN670SQ2□ | 67Ω±25% | 330mA | 50Vdc | 10MΩ | 125Vdc | 0.35Ω max. |
| DLW21HN900SQ2□ | 90Ω±25% | 330mA | 50Vdc | 10MΩ | 125Vdc | 0.35Ω max. |
| DLW21HN121SQ2□ | 120Ω±25% | 280mA | 50Vdc | 10MΩ | 125Vdc | 0.45Ω max. |
| DLW21HN181SQ2□ | 180Ω±25% | 250mA | 50Vdc | 10MΩ | 125Vdc | 0.50Ω max. |
| DLW21HN670HQ2□ | 67Ω±25% | 240mA | 20Vdc | 10MΩ | 50Vdc | 0.49Ω max. |
| DLW21HN900HQ2□ | 90Ω±25% | 220mA | 20Vdc | 10MΩ | 50Vdc | 0.59Ω max. |
| DLW21HN121HQ2□ | 120Ω±25% | 200mA | 20Vdc | 10MΩ | 50Vdc | 0.68Ω max. |

Operating Temp. Range: -40°C to 85°C

Z-f Characteristics: DLW21HN_SQ2 Series

Z-f Characteristics: DLW21HN_HQ2 Series

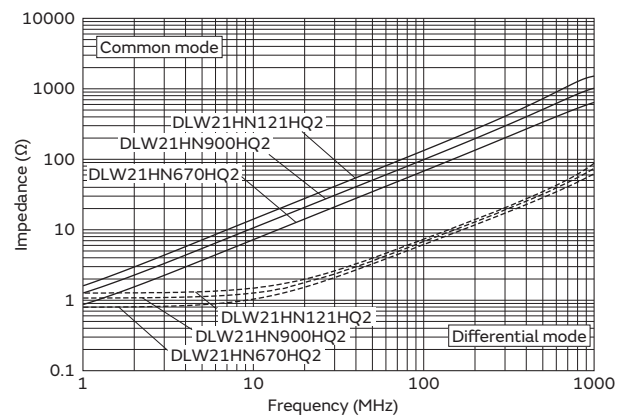
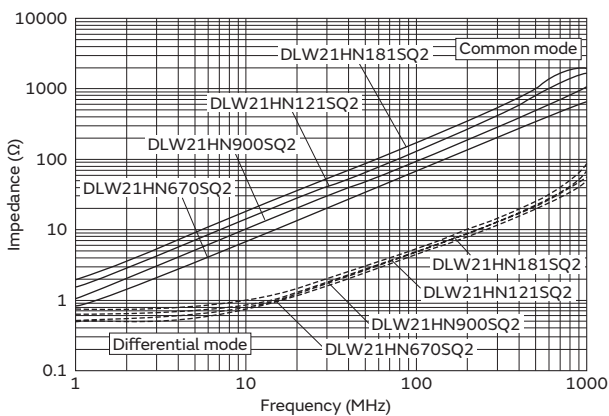

Continued on the following page. ↗

Continued from the preceding page. ↘

Differential mode transmission characteristics: DLW21HN_HQ2series

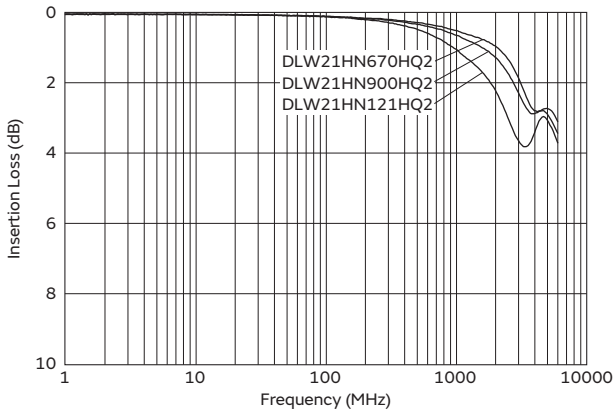

Chip Ferrite Bead

Application Specified Noise Filter

Chip EMIFIL®

Common Mode Choke Coil
Common Mode Noise Filter

Block Type EMIFIL®

EMC Absorber

Common mode choke coil/Common mode noise filter

DLW21S Series 0805/2012(inch/mm)

Appearance/Dimensions

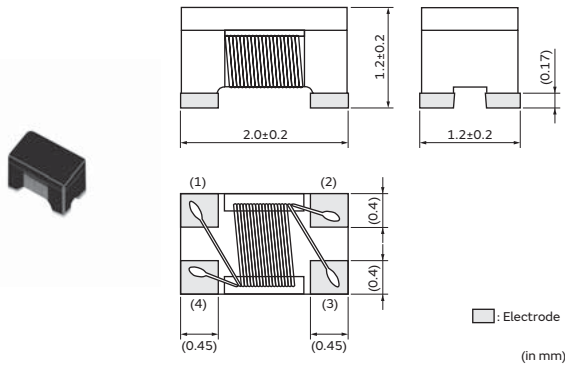

Packaging

| Code | Packaging | Minimum Quantity |
|------|----------------------|------------------|
| L | ø180mm Embossed Tape | 2000 |
| B | Bulk(Bag) | 500 |

Equivalent Circuit

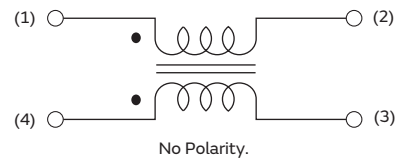

Rated Value (□: packaging code)

| Part Number | Common Mode Impedance at 100MHz | Rated Current | Rated Voltage | Insulation Resistance (Min.) | Withstanding Voltage | DC Resistance |
|----------------|---------------------------------|---------------|---------------|------------------------------|----------------------|---------------|
| DLW21SN670SQ2□ | 67Ω±25% | 400mA | 50Vdc | 10MΩ | 125Vdc | 0.25Ω max. |
| DLW21SN900SQ2□ | 90Ω±25% | 330mA | 50Vdc | 10MΩ | 125Vdc | 0.35Ω max. |
| DLW21SN121SQ2□ | 120Ω±25% | 370mA | 50Vdc | 10MΩ | 125Vdc | 0.30Ω max. |
| DLW21SN181SQ2□ | 180Ω±25% | 330mA | 50Vdc | 10MΩ | 125Vdc | 0.35Ω max. |
| DLW21SN261SQ2□ | 260Ω±25% | 300mA | 50Vdc | 10MΩ | 125Vdc | 0.40Ω max. |
| DLW21SN371SQ2□ | 370Ω±25% | 280mA | 50Vdc | 10MΩ | 125Vdc | 0.45Ω max. |
| DLW21SN501SK2□ | 500Ω±25% | 250mA | 50Vdc | 10MΩ | 125Vdc | 0.5Ω max. |
| DLW21SN921SK2□ | 920Ω±25% | 160mA | 50Vdc | 10MΩ | 125Vdc | 0.95Ω max. |
| DLW21SN670HQ2□ | 67Ω±25% | 320mA | 20Vdc | 10MΩ | 50Vdc | 0.31Ω max. |
| DLW21SN900HQ2□ | 90Ω±25% | 280mA | 20Vdc | 10MΩ | 50Vdc | 0.41Ω max. |
| DLW21SN121HQ2□ | 120Ω±25% | 280mA | 20Vdc | 10MΩ | 50Vdc | 0.41Ω max. |
| DLW21SN211XK2□ | 210Ω±25% | 360mA | 20Vdc | 10MΩ | 50Vdc | 0.33Ω max. |
| DLW21SN181XQ2□ | 180Ω±25% | 240mA | 20Vdc | 10MΩ | 50Vdc | 0.39Ω max. |
| DLW21SN261XQ2□ | 260Ω±25% | 220mA | 20Vdc | 10MΩ | 50Vdc | 0.59Ω max. |
| DLW21SN491XQ2□ | 490Ω±25% | 190mA | 20Vdc | 10MΩ | 50Vdc | 0.77Ω max. |
| DLW21SR670HQ2□ | 67Ω±25% | 400mA | 20Vdc | 10MΩ | 50Vdc | 0.25Ω max. |

Operating Temp. Range: -40°C to 85°C

Continued on the following page. ↗

Continued from the preceding page. ↘

Z-f Characteristics: DLW21SN_SQ2/SK2 Series

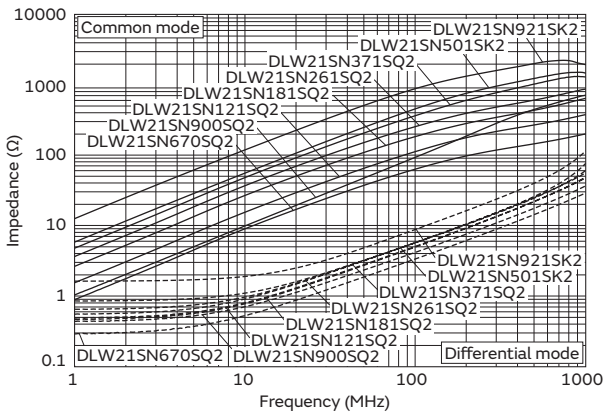

Z-f Characteristics: DLW21SN_HQ2 Series

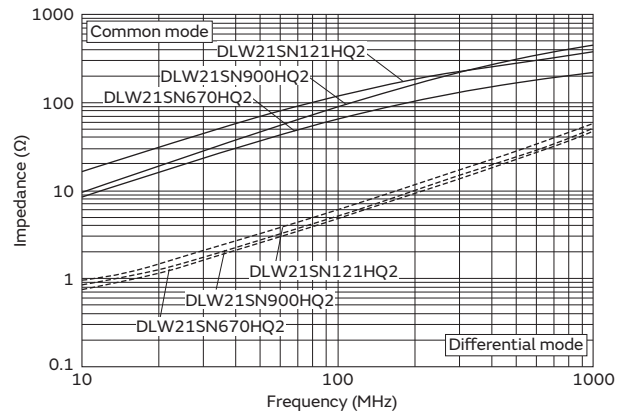

Differential mode transmission characteristics: DLW21SN_HQ2series

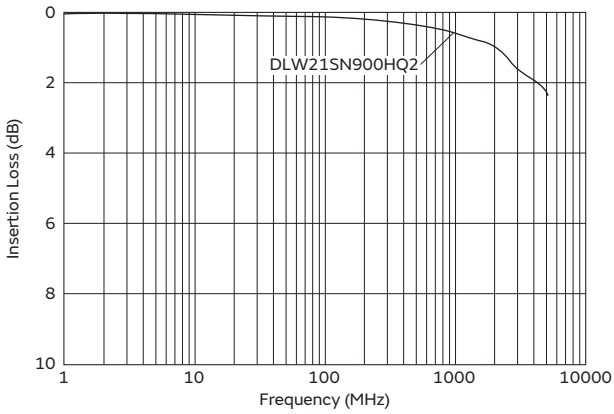

Z-f Characteristics: DLW21SN_XK2/XQ2 Series

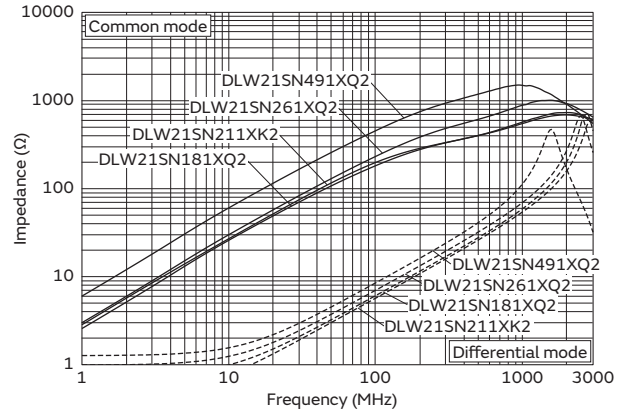

Continued on the following page. ↗

Chip Ferrite Bead

Application Specified Noise Filter

Chip EMIFIL®

Common Mode Choke Coil
 Common Mode Noise Filter

Block Type EMIFIL®

EMC Absorber

Continued from the preceding page. ↘

Differential mode transmission characteristics: DLW21SN_XK2series

Differential mode transmission characteristics: DLW21SN_XQ2series

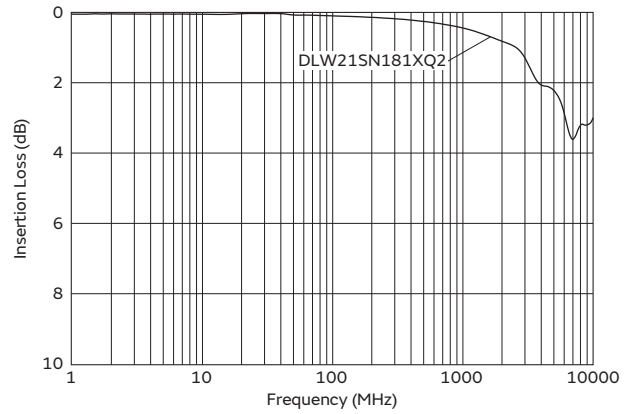
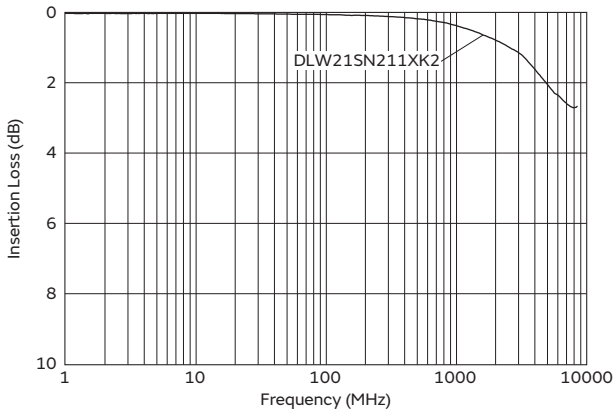

Z-f Characteristics: DLW21SR_HQ2 Series

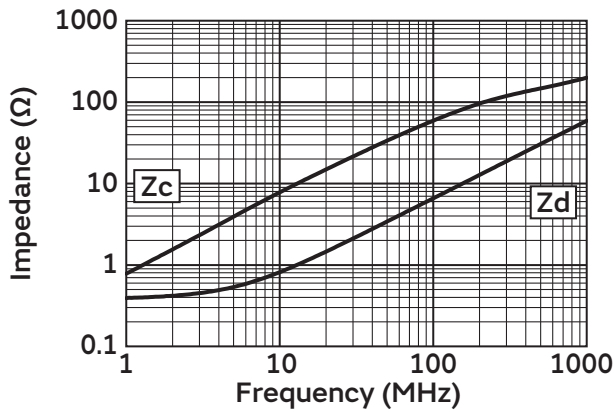

Chip Ferrite Bead

Application Specified Noise Filter

Chip EMIFIL®

Common Mode Choke Coil
 Common Mode Noise Filter

Block Type EMIFIL®

EMC Absorber

Common mode choke coil/Common mode noise filter

DLW31S Series 1206/3216(inch/mm)

Appearance/Dimensions

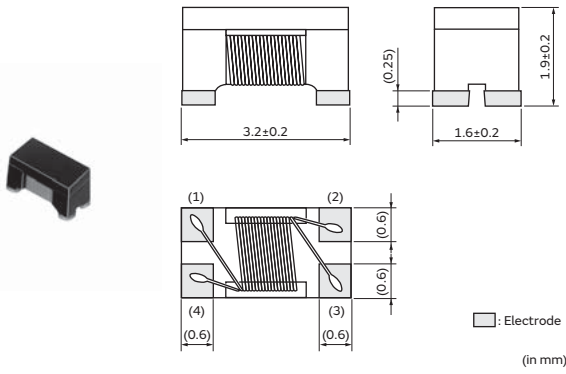

Packaging

| Code | Packaging | Minimum Quantity |
|------|----------------------|------------------|
| L | ø180mm Embossed Tape | 2000 |
| B | Bulk(Bag) | 500 |

Equivalent Circuit

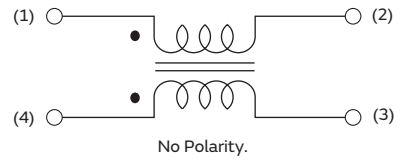

Rated Value (□: packaging code)

| Part Number | Common Mode Impedance at 100MHz | Rated Current | Rated Voltage | Insulation Resistance (Min.) | Withstanding Voltage | DC Resistance |
|----------------|---------------------------------|---------------|---------------|------------------------------|----------------------|---------------|
| DLW31SN900SQ2□ | 90Ω±25% | 370mA | 50Vdc | 10MΩ | 125Vdc | 0.3Ω max. |
| DLW31SN161SQ2□ | 160Ω±25% | 340mA | 50Vdc | 10MΩ | 125Vdc | 0.4Ω max. |
| DLW31SN261SQ2□ | 260Ω±25% | 310mA | 50Vdc | 10MΩ | 125Vdc | 0.5Ω max. |
| DLW31SN601SQ2□ | 600Ω±25% | 260mA | 50Vdc | 10MΩ | 125Vdc | 0.8Ω max. |
| DLW31SN102SQ2□ | 1000Ω±25% | 230mA | 50Vdc | 10MΩ | 125Vdc | 1.0Ω max. |
| DLW31SN222SQ2□ | 2200Ω±25% | 200mA | 50Vdc | 10MΩ | 125Vdc | 1.2Ω max. |

Operating Temp. Range: -40°C to 85°C

Z-f Characteristics: DLW31SN_SQ2 Series

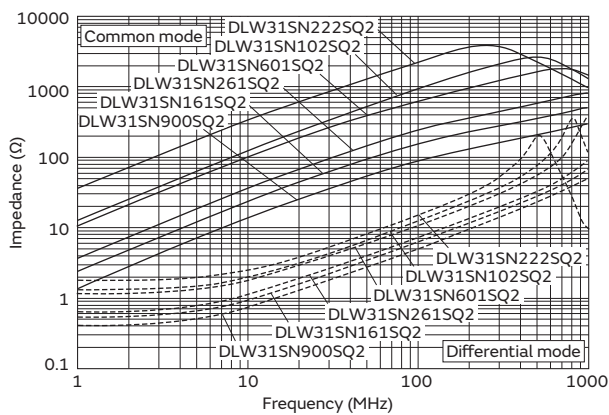

Common mode choke coil/Common mode noise filter

NFPOQ Series 025020/0605(inch/mm)

Appearance/Dimensions

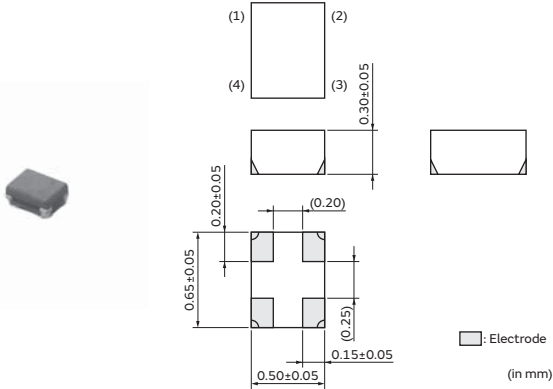

Packaging

| Code | Packaging | Minimum Quantity |
|------|-------------------|------------------|
| D | ø180mm Paper Tape | 15000 |
| B | Bulk(Bag) | 500 |

Equivalent Circuit

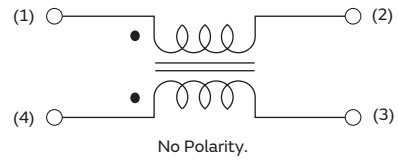

Rated Value (□: packaging code)

| Part Number | Common Mode Impedance at 100MHz | Cutoff Frequency | Common Mode Insertion Loss | Rated Current | Rated Voltage | Insulation Resistance (Min.) | Withstanding Voltage | DC Resistance |
|----------------|---------------------------------|------------------|---|---------------|---------------|------------------------------|----------------------|---------------|
| NFPOQHB242HS2□ | - | 8.5GHz (Typ.) | 27dB Typ.(2.0GHz), 43dB Typ.(2.4GHz), 23dB Typ.(3.0GHz) | 100mA | 5Vdc | 100MΩ | 12.5Vdc | 1.7Ω±30% |
| NFPOQHB372HS2□ | - | 10GHz (Typ.) | 15dB Typ.(2.4GHz), 40dB Typ.(3.7GHz), 15dB Typ.(6.0GHz) | 100mA | 5Vdc | 100MΩ | 12.5Vdc | 2.2Ω±30% |
| NFPOQHB542HS2□ | - | 10GHz (Typ.) | 30dB Typ.(5.0GHz), 40dB Typ.(5.4GHz), 25dB Typ.(6.0GHz) | 100mA | 5Vdc | 100MΩ | 12.5Vdc | 1.5Ω±30% |
| NFPOQSB132HL2□ | 90Ω(Typ.) | 7.5GHz (Typ.) | 20dB Typ.(700MHz), 23dB Typ.(900MHz), 25dB Typ.(1.7GHz), 22dB Typ.(2.4GHz), 14dB Typ.(5.0GHz) | 100mA | 5Vdc | 100MΩ | 12.5Vdc | 2.0Ω±30% |

Operating Temp. Range: -40°C to 85°C

Common mode insertion loss: NFPOQHB_HS2series

Differential mode transmission characteristics: NFPOQHB_HS2series

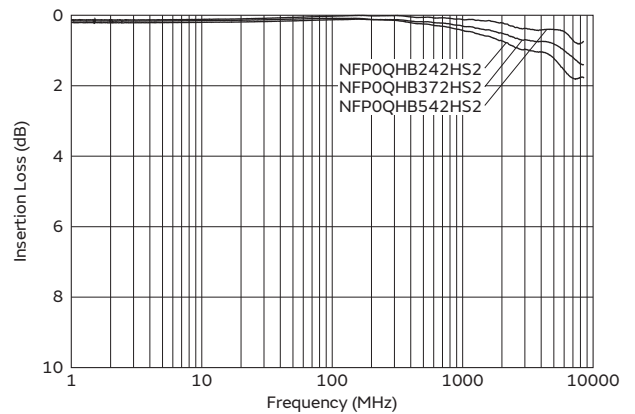
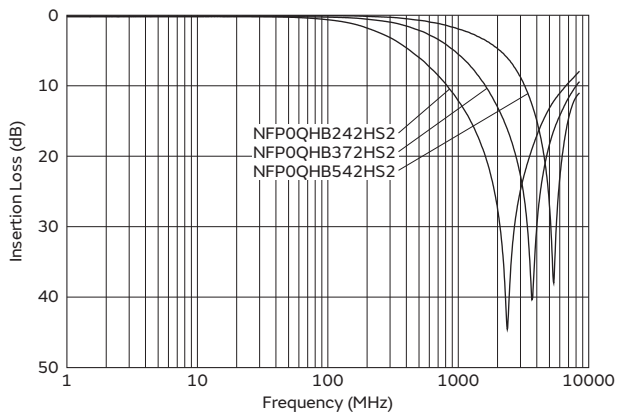

Continued on the following page. ↗

Continued from the preceding page. ↘

Common mode insertion loss: NFP0QSB_HL2series

Differential mode transmission characteristics: NFP0QSB_HL2series

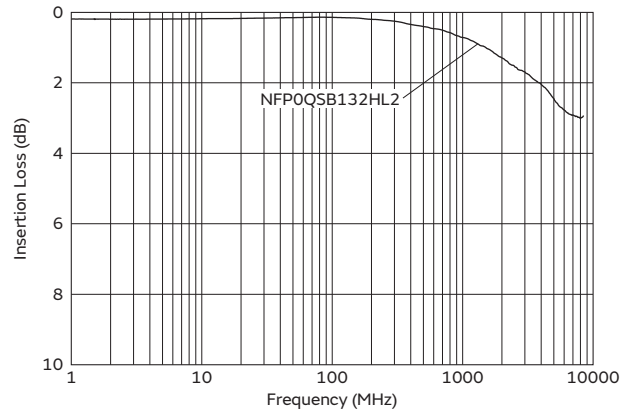
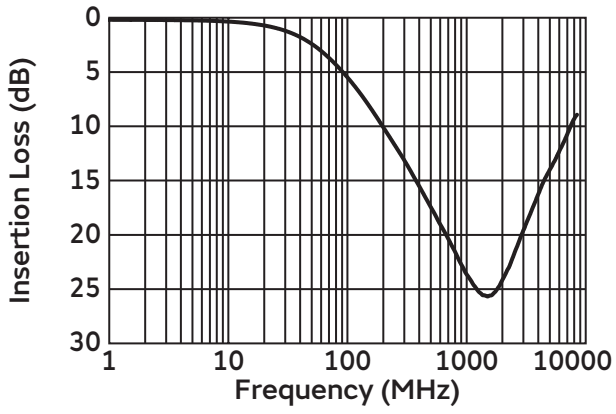

Chip Ferrite Bead

Application Specified Noise Filter

Chip EMIFIL®

Common Mode Choke Coil
 Common Mode Noise Filter

Block Type EMIFIL®

EMC Absorber

Common mode choke coil/Common mode noise filter

DLW44S Series 1515/4040(inch/mm)

Appearance/Dimensions

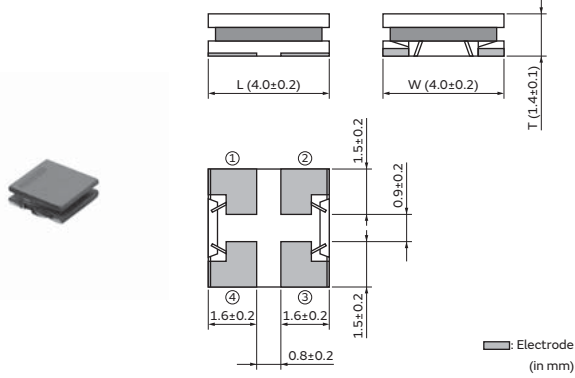

Packaging

| Code | Packaging | Minimum Quantity |
|------|----------------------|------------------|
| K | ø330mm Embossed Tape | 3500 |
| L | ø180mm Embossed Tape | 1000 |
| B | Bulk(Bag) | 100 |

Equivalent Circuit

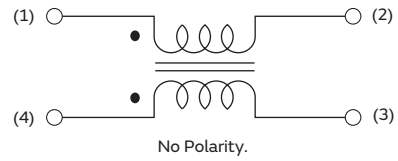

Rated Value (□: packaging code)

| Part Number | Common Mode Impedance at 10MHz | Common Mode Impedance at 100MHz | Rated Current | Rated Voltage | Insulation Resistance (Min.) | Withstanding Voltage | DC Resistance |
|----------------|--------------------------------|---------------------------------|---------------|---------------|------------------------------|----------------------|---------------|
| DLW44SM101SK2□ | 10Ω±40% | 100Ω(Typ.) | 3.1A | 60Vdc | 10MΩ | 150Vdc | 0.016Ω±40% |
| DLW44SM251SK2□ | 24Ω±40% | 250Ω(Typ.) | 2.6A | 60Vdc | 10MΩ | 150Vdc | 0.024Ω±40% |
| DLW44SM401SK2□ | 37.5Ω±40% | 400Ω(Typ.) | 2.1A | 60Vdc | 10MΩ | 150Vdc | 0.030Ω±40% |
| DLW44SM851SK2□ | 65Ω±40% | 850Ω(Typ.) | 1.9A | 60Vdc | 10MΩ | 150Vdc | 0.040Ω±40% |
| DLW44SM172SK2□ | 100Ω±40% | 1700Ω(Typ.) | 1.5A | 60Vdc | 10MΩ | 150Vdc | 0.060Ω±40% |
| DLW44SM302SK2□ | 180Ω±40% | 2200Ω(Typ.) | 1.1A | 60Vdc | 10MΩ | 150Vdc | 0.120Ω±40% |
| DLW44SM242SK2□ | 140Ω±40% | 2400Ω(Typ.) | 1.4A | 60Vdc | 10MΩ | 150Vdc | 0.075Ω±40% |

Operating Temp. Range: -40°C to 105°C

Z-f Characteristics: DLW44SM_SK2 Series

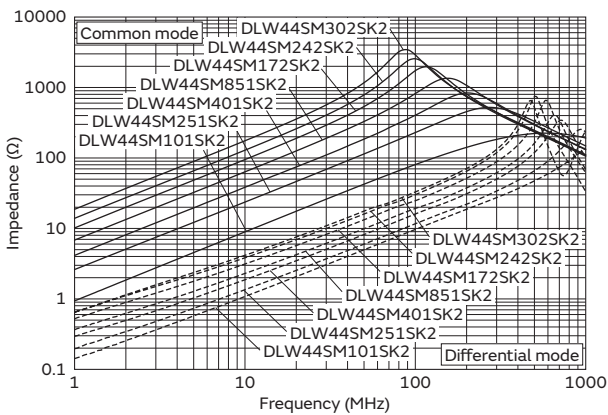

Derating of Rated Current

In operating temperature exceeding +85°C, derating of current is necessary for DLW44S series. Please apply the derating curve shown in chart according to the operating temperature.

Derating of Rated Current

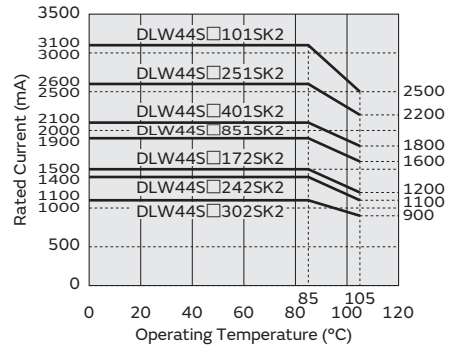

Common mode choke coil/Common mode noise filter

DLW5AH_SQ2 Series 2014/5036(inch/mm)/DLW5BS_SQ2 Series 2020/5050(inch/mm)

Appearance/Dimensions

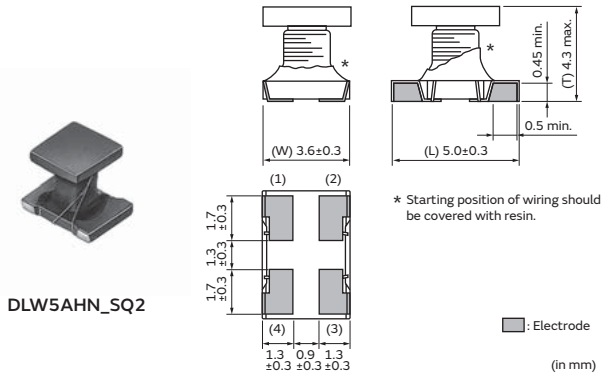

Packaging

| Code | Packaging | Minimum Quantity |
|------|----------------------|------------------|
| K | ø330mm Embossed Tape | 1500 |
| L | ø180mm Embossed Tape | 400 |
| B | Bulk(Bag) | 100 |

Equivalent Circuit

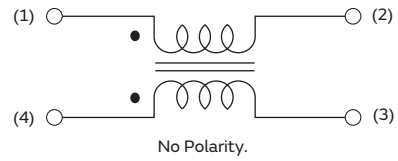

Appearance/Dimensions

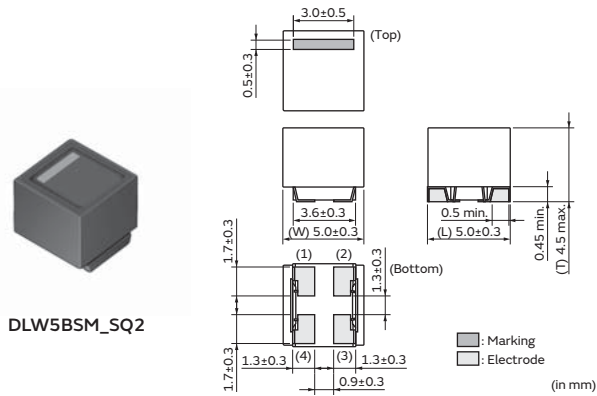

Packaging

| Code | Packaging | Minimum Quantity |
|------|----------------------|------------------|
| K | ø330mm Embossed Tape | 1500 |
| L | ø180mm Embossed Tape | 400 |
| B | Bulk(Bag) | 100 |

Equivalent Circuit

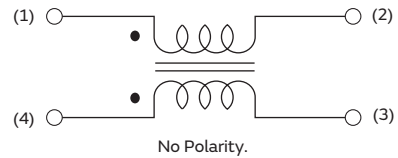

Rated Value (□: packaging code)

| Part Number | Common Mode Impedance at 10MHz | Common Mode Impedance at 100MHz | Rated Current | Rated Voltage | Insulation Resistance (Min.) | Withstanding Voltage | DC Resistance | Operating Temp. Range |
|----------------|--------------------------------|---------------------------------|---------------|---------------|------------------------------|----------------------|---------------|-----------------------|
| DLW5AHN402SQ2□ | 300Ωmin. | 4000Ω(Typ.) | 200mA | 50Vdc | 10MΩ | 125Vdc | 3.0Ω max. | -25°C to 85°C |
| DLW5BSM191SQ2□ | 19Ωmin. | 190Ω(Typ.) | 5A | 50Vdc | 10MΩ | 125Vdc | 0.02Ω max. | -40°C to 85°C |
| DLW5BSM351SQ2□ | 50Ωmin. | 350Ω(Typ.) | 2A | 50Vdc | 10MΩ | 125Vdc | 0.04Ω max. | -40°C to 85°C |
| DLW5BSM102SQ2□ | 100Ωmin. | 1000Ω(Typ.) | 1.5A | 50Vdc | 10MΩ | 125Vdc | 0.06Ω max. | -40°C to 85°C |
| DLW5BSM152SQ2□ | 150Ωmin. | 1500Ω(Typ.) | 1A | 50Vdc | 10MΩ | 125Vdc | 0.1Ω max. | -40°C to 85°C |
| DLW5BSM302SQ2□ | 300Ωmin. | 3000Ω(Typ.) | 500mA | 50Vdc | 10MΩ | 125Vdc | 0.3Ω max. | -40°C to 85°C |

Continued on the following page. ↗

Continued from the preceding page. ↘

Z-f Characteristics: DLW5AH_SQ2/DLW5BS_SQ2 Series

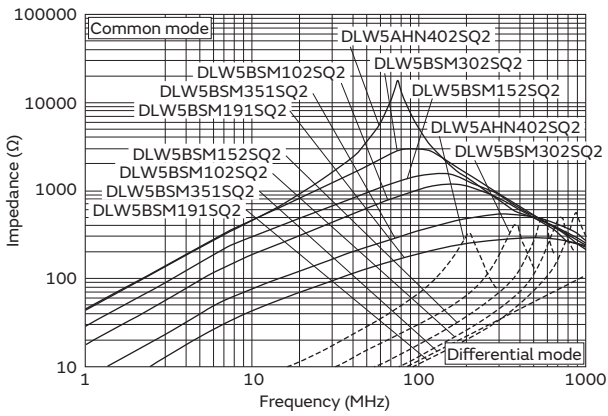

Derating of Rated Current

In operating temperature exceeding +75°C, derating of current is necessary for DLW5BSM191SQ2. Please apply the derating curve shown in chart according to the operating temperature.

Derating of Rated Current

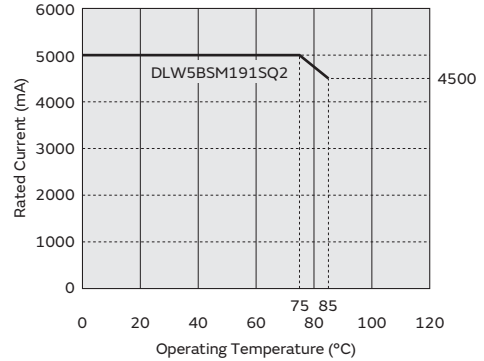

Chip Ferrite Bead

Application Specified Noise Filter

Chip EMIFIL®

Common Mode Choke Coil
 Common Mode Noise Filter

Block Type EMIFIL®

EMC Absorber

Common mode choke coil/Common mode noise filter

DLW5AT_SQ2 Series 2014/5036(inch/mm)

Appearance/Dimensions

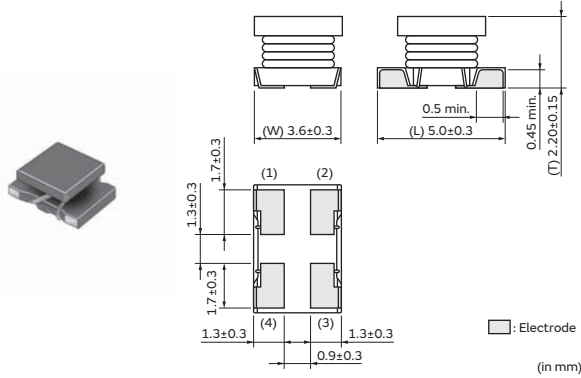

Packaging

| Code | Packaging | Minimum Quantity |
|------|----------------------|------------------|
| K | ø330mm Embossed Tape | 2500 |
| L | ø180mm Embossed Tape | 700 |
| B | Bulk(Bag) | 100 |

Equivalent Circuit

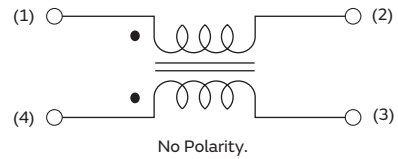

Rated Value (□: packaging code)

| Part Number | Common Mode Impedance at 10MHz | Common Mode Impedance at 100MHz | Rated Current | Rated Voltage | Insulation Resistance (Min.) | Withstanding Voltage | DC Resistance |
|----------------|--------------------------------|---------------------------------|---------------|---------------|------------------------------|----------------------|---------------|
| DLW5ATN111SQ2□ | 12Ω±25% | 110Ω(Typ.) | 5A | 50Vdc | 10MΩ | 125Vdc | 0.020Ω max. |
| DLW5ATN401SQ2□ | 35Ω±25% | 400Ω(Typ.) | 2A | 50Vdc | 10MΩ | 125Vdc | 0.034Ω max. |
| DLW5ATN501SQ2□ | 55Ω±25% | 500Ω(Typ.) | 1.5A | 50Vdc | 10MΩ | 125Vdc | 0.056Ω max. |
| DLW5ATN851SQ2□ | 60Ω±25% | 850Ω(Typ.) | 1.5A | 50Vdc | 10MΩ | 125Vdc | 0.073Ω max. |
| DLW5ATN272SQ2□ | 100Ω±25% | 2700Ω(Typ.) | 1A | 50Vdc | 10MΩ | 125Vdc | 0.12Ω max. |

Operating Temp. Range: -40°C to 85°C

Z-f Characteristics: DLW5ATN_SQ2 Series

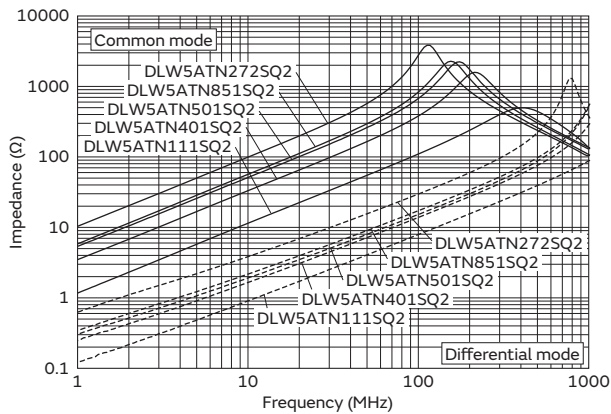

Derating of Rated Current

In operating temperature exceeding +60°C, derating of current is necessary for DLW5AT series. Please apply the derating curve shown in chart according to the operating temperature.

Derating of Rated Current

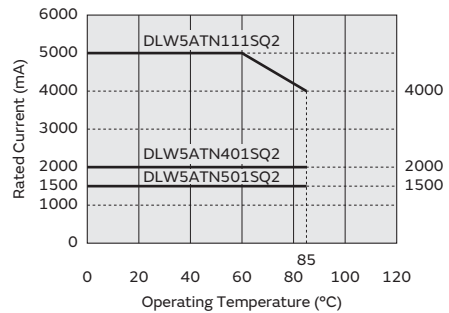

Continued on the following page. ↗

Continued from the preceding page. ↘

Derating of Rated Current

In operating temperature exceeding +75°C, derating of current is necessary for DLW5AT series.
Please apply the derating curve shown in chart according to the operating temperature.

Derating of Rated Current

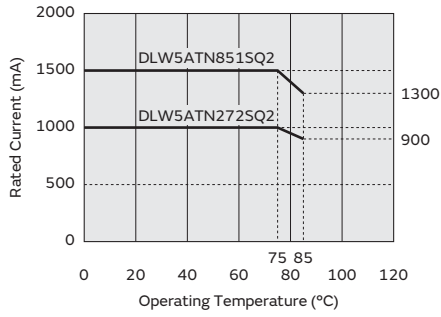

Common mode choke coil/Common mode noise filter

DLW5AT_MQ2 Series 2014/5036(inch/mm)

Appearance/Dimensions

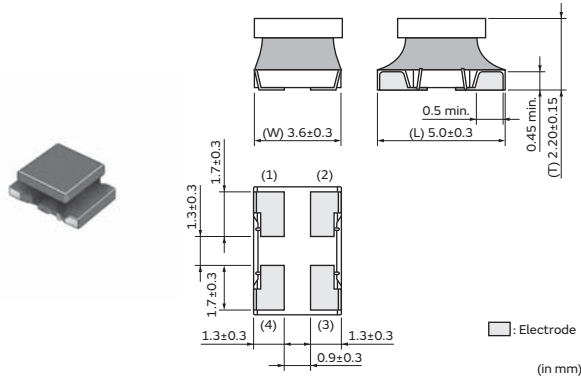

Packaging

| Code | Packaging | Minimum Quantity |
|------|----------------------|------------------|
| K | ø330mm Embossed Tape | 2500 |
| L | ø180mm Embossed Tape | 700 |
| B | Bulk(Bag) | 100 |

Equivalent Circuit

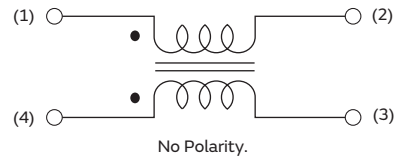

Rated Value (□: packaging code)

| Part Number | Common Mode Impedance at 10MHz | Common Mode Impedance at 100MHz | Rated Current | Rated Voltage | Insulation Resistance (Min.) | Withstanding Voltage | DC Resistance |
|----------------|--------------------------------|---------------------------------|---------------|---------------|------------------------------|----------------------|---------------|
| DLW5ATN500MQ2□ | 4.6Ωmin. | 50Ω(Typ.) | 6A | 50Vdc | 10MΩ | 125Vdc | 0.013Ω max. |
| DLW5ATN151MQ2□ | 11Ωmin. | 150Ω(Typ.) | 5A | 50Vdc | 10MΩ | 125Vdc | 0.020Ω max. |
| DLW5ATN331MQ2□ | 20Ωmin. | 330Ω(Typ.) | 4A | 50Vdc | 10MΩ | 125Vdc | 0.027Ω max. |
| DLW5ATN501MQ2□ | 35Ωmin. | 500Ω(Typ.) | 2.5A | 50Vdc | 10MΩ | 125Vdc | 0.034Ω max. |
| DLW5ATN112MQ2□ | 50Ωmin. | 1100Ω(Typ.) | 2A | 50Vdc | 10MΩ | 125Vdc | 0.056Ω max. |

Operating Temp. Range: -40°C to 105°C

Z-f Characteristics: DLW5ATN_MQ2 Series

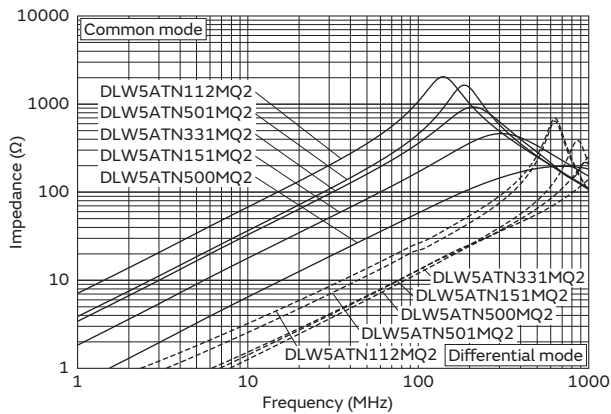

Derating of Rated Current

In operating temperature exceeding +85°C, derating of current is necessary for DLW5AT series (105 degree C available type). Please apply the derating curve shown in chart according to the operating temperature.

Derating of Rated Current

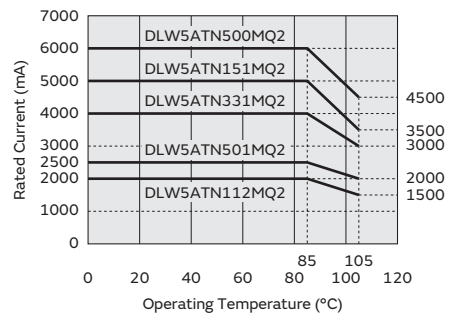

Common mode choke coil/Common mode noise filter

DLW5AT_TQ2 Series 2014/5036(inch/mm)

Appearance/Dimensions

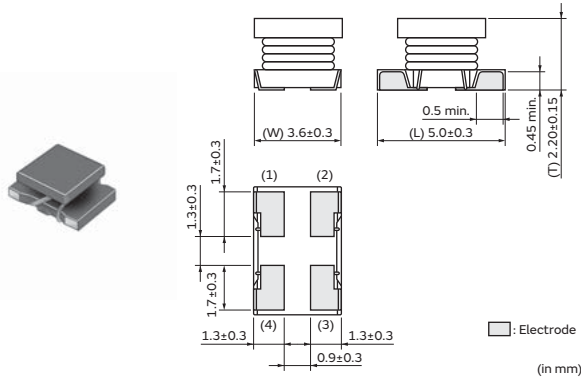

Packaging

| Code | Packaging | Minimum Quantity |
|------|----------------------|------------------|
| K | ø330mm Embossed Tape | 2500 |
| L | ø180mm Embossed Tape | 700 |
| B | Bulk(Bag) | 100 |

Equivalent Circuit

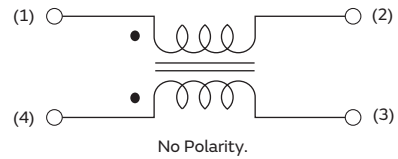

Rated Value (□: packaging code)

| Part Number | Common Mode Impedance at 10MHz | Common Mode Impedance at 100MHz | Rated Current | Rated Voltage | Insulation Resistance (Min.) | Withstanding Voltage | DC Resistance |
|----------------|--------------------------------|---------------------------------|---------------|---------------|------------------------------|----------------------|---------------|
| DLW5ATN111TQ2□ | 12Ω±25% | 110Ω(Typ.) | 5A | 50Vdc | 10MΩ | 125Vdc | 0.020Ω max. |
| DLW5ATN231TQ2□ | 22Ω±25% | 230Ω(Typ.) | 4A | 50Vdc | 10MΩ | 125Vdc | 0.027Ω max. |
| DLW5ATN401TQ2□ | 35Ω±25% | 400Ω(Typ.) | 2.5A | 50Vdc | 10MΩ | 125Vdc | 0.034Ω max. |
| DLW5ATN501TQ2□ | 55Ω±25% | 500Ω(Typ.) | 2A | 50Vdc | 10MΩ | 125Vdc | 0.056Ω max. |

Operating Temp. Range: -40°C to 105°C

Z-f Characteristics: DLW5ATN_TQ2 Series

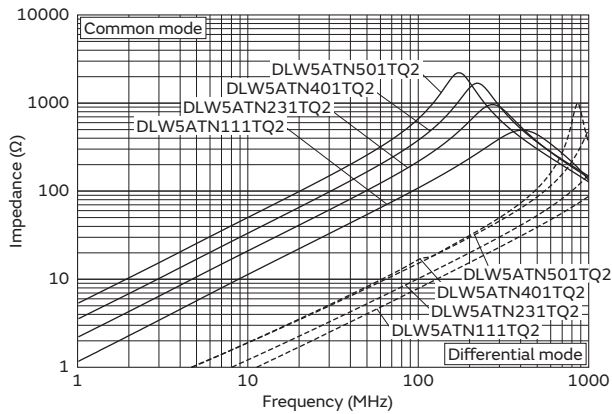

Derating of Rated Current

In operating temperature exceeding +85°C, derating of current is necessary for DLW5AT series (105 degree C available type). Please apply the derating curve shown in chart according to the operating temperature.

Derating of Rated Current

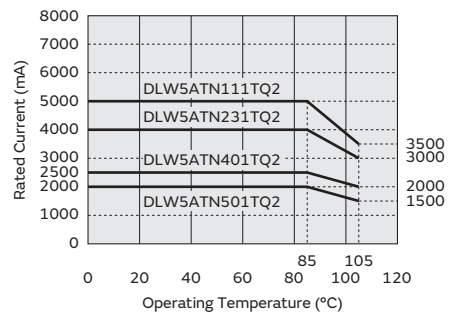

Common mode choke coil/Common mode noise filter

DLW5BS_TQ2 Series 2020/5050(inch/mm)

Appearance/Dimensions

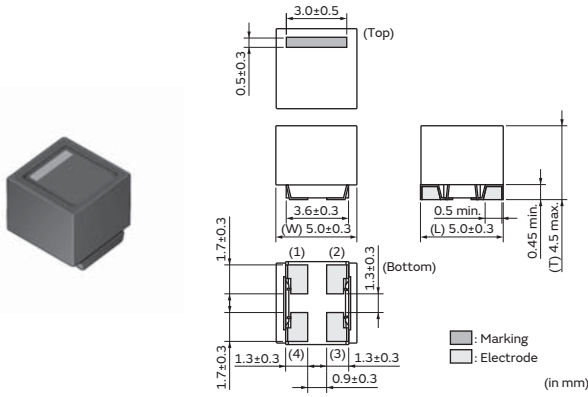

Packaging

| Code | Packaging | Minimum Quantity |
|------|----------------------|------------------|
| K | ø330mm Embossed Tape | 1500 |
| L | ø180mm Embossed Tape | 400 |
| B | Bulk(Bag) | 100 |

Equivalent Circuit

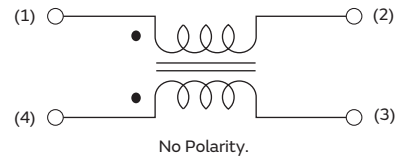

Rated Value (□: packaging code)

| Part Number | Common Mode Impedance at 10MHz | Common Mode Impedance at 100MHz | Rated Current | Rated Voltage | Insulation Resistance (Min.) | Withstanding Voltage | DC Resistance |
|----------------|--------------------------------|---------------------------------|---------------|---------------|------------------------------|----------------------|---------------|
| DLW5BSM501TQ2□ | 2800Ω±40% | 500Ω(Typ.) | 1A | 50Vdc | 10MΩ | 125Vdc | 0.23Ω max. |
| DLW5BSM601TQ2□ | 1200Ω±40% | 600Ω(Typ.) | 1.4A | 50Vdc | 10MΩ | 125Vdc | 0.12Ω max. |
| DLW5BSM801TQ2□ | 550Ω±40% | 800Ω(Typ.) | 2A | 50Vdc | 10MΩ | 125Vdc | 0.056Ω max. |

Operating Temp. Range: -40°C to 105°C

Z-f Characteristics: DLW5BSM_TQ2 Series

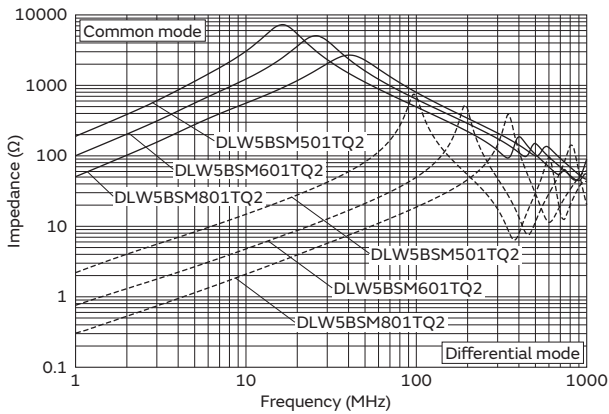

Derating of Rated Current

In operating temperature exceeding +65°C, derating of current is necessary for DLW5BS_TQ2 series. Please apply the derating curve shown in chart according to the operating temperature.

Derating of Rated Current

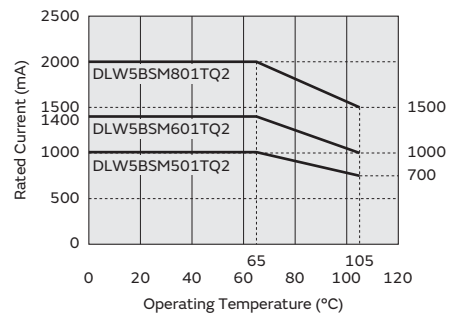

Common mode choke coil/Common mode noise filter

DLW5BT_SQ2 Series 2020/5050(inch/mm)

Appearance/Dimensions

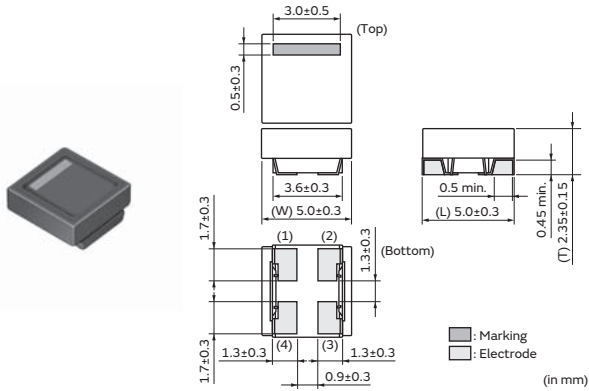

Packaging

| Code | Packaging | Minimum Quantity |
|------|----------------------|------------------|
| K | ø330mm Embossed Tape | 2500 |
| L | ø180mm Embossed Tape | 700 |
| B | Bulk(Bag) | 100 |

Equivalent Circuit

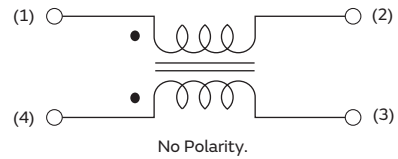

Rated Value (□: packaging code)

| Part Number | Common Mode Impedance at 10MHz | Common Mode Impedance at 100MHz | Rated Current | Rated Voltage | Insulation Resistance (Min.) | Withstanding Voltage | DC Resistance |
|----------------|--------------------------------|---------------------------------|---------------|---------------|------------------------------|----------------------|---------------|
| DLW5BTM101SQ2□ | 10Ωmin. | 100Ω(Typ.) | 6A | 50Vdc | 10MΩ | 125Vdc | 0.013Ω max. |
| DLW5BTM251SQ2□ | 20Ωmin. | 250Ω(Typ.) | 5A | 50Vdc | 10MΩ | 125Vdc | 0.020Ω max. |
| DLW5BTM501SQ2□ | 30Ωmin. | 500Ω(Typ.) | 4A | 50Vdc | 10MΩ | 125Vdc | 0.027Ω max. |
| DLW5BTM102SQ2□ | 60Ωmin. | 1000Ω(Typ.) | 2A | 50Vdc | 10MΩ | 125Vdc | 0.034Ω max. |
| DLW5BTM142SQ2□ | 100Ωmin. | 1400Ω(Typ.) | 1.5A | 50Vdc | 10MΩ | 125Vdc | 0.056Ω max. |

Operating Temp. Range: -40°C to 85°C

Z-f Characteristics: DLW5BTM_SQ2 Series

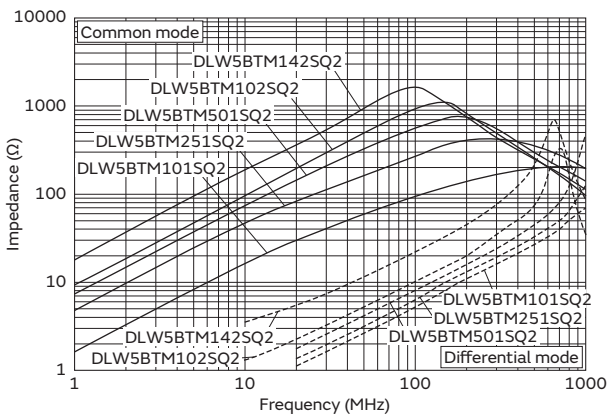

Derating of Rated Current

In operating temperature exceeding +60°C, derating of current is necessary for the following part name of DLW5BT series. Please apply the derating curve shown in chart according to the operating temperature.

Derating of Rated Current

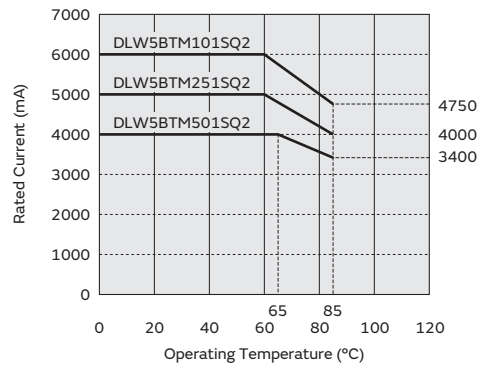

Common mode choke coil/Common mode noise filter

DLW5BT_TQ2 Series 2020/5050(inch/mm)

Appearance/Dimensions

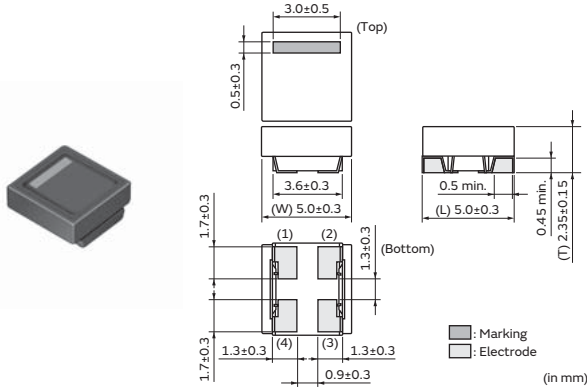

Packaging

| Code | Packaging | Minimum Quantity |
|------|----------------------|------------------|
| K | ø330mm Embossed Tape | 2500 |
| L | ø180mm Embossed Tape | 700 |
| B | Bulk(Bag) | 100 |

Equivalent Circuit

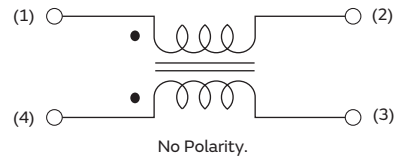

Rated Value (□: packaging code)

| Part Number | Common Mode Impedance at 10MHz | Common Mode Impedance at 100MHz | Rated Current | Rated Voltage | Insulation Resistance (Min.) | Withstanding Voltage | DC Resistance |
|----------------|--------------------------------|---------------------------------|---------------|---------------|------------------------------|----------------------|---------------|
| DLW5BTM101TQ2□ | 10Ωmin. | 100Ω(Typ.) | 6A | 50Vdc | 10MΩ | 125Vdc | 0.013Ω max. |
| DLW5BTM251TQ2□ | 20Ωmin. | 250Ω(Typ.) | 5A | 50Vdc | 10MΩ | 125Vdc | 0.020Ω max. |
| DLW5BTM501TQ2□ | 30Ωmin. | 500Ω(Typ.) | 4A | 50Vdc | 10MΩ | 125Vdc | 0.027Ω max. |
| DLW5BTM102TQ2□ | 60Ωmin. | 1000Ω(Typ.) | 2.5A | 50Vdc | 10MΩ | 125Vdc | 0.034Ω max. |
| DLW5BTM142TQ2□ | 100Ωmin. | 1400Ω(Typ.) | 2A | 50Vdc | 10MΩ | 125Vdc | 0.056Ω max. |

Operating Temp. Range: -40°C to 105°C

Z-f Characteristics: DLW5BTM_TQ2 Series

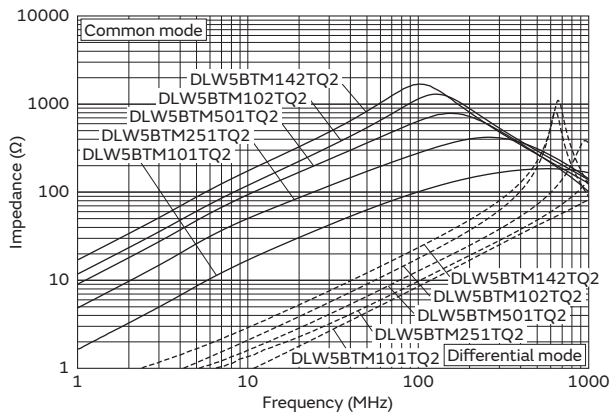

Derating of Rated Current

In operating temperature exceeding +85°C, derating of current is necessary for DLW5BT series (105 degree C available type). Please apply the derating curve shown in chart according to the operating temperature.

Derating of Rated Current

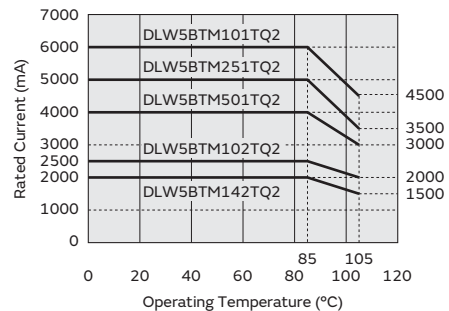

Common mode choke coil/Common mode noise filter

PLT5BPH Series 2020/5050(inch/mm)

Appearance/Dimensions

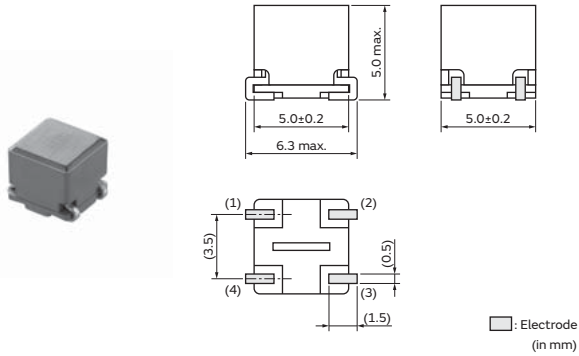

Packaging

| Code | Packaging | Minimum Quantity |
|------|----------------------|------------------|
| L | ø180mm Embossed Tape | 300 |
| B | Bulk(Bag) | 50 |

Equivalent Circuit

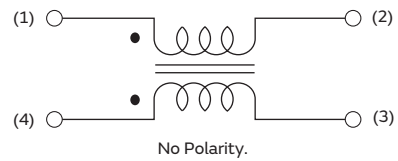

Rated Value (□: packaging code)

| Part Number | Common Mode Impedance at 10MHz | Rated Current | Rated Voltage | Insulation Resistance (Min.) | Withstanding Voltage | DC Resistance |
|------------------|--------------------------------|---------------|---------------|------------------------------|----------------------|---------------|
| PLT5BPH1015R6SN□ | 100Ω(Typ.) | 5.6A | 80Vdc | 10MΩ | 200Vdc | 4mΩ±30% |
| PLT5BPH2014R4SN□ | 200Ω(Typ.) | 4.4A | 80Vdc | 10MΩ | 200Vdc | 7mΩ±30% |
| PLT5BPH3013R7SN□ | 300Ω(Typ.) | 3.7A | 80Vdc | 10MΩ | 200Vdc | 11mΩ±30% |
| PLT5BPH5013R1SN□ | 500Ω(Typ.) | 3.1A | 80Vdc | 10MΩ | 200Vdc | 17mΩ±30% |

Operating Temp. Range: -55°C to 150°C

Z-f characteristics: PLT5BPH series

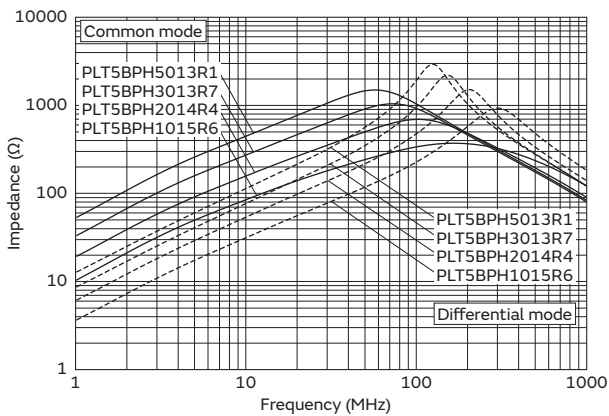

Derating of Rated Current

In operating temperature exceeding +125°C, derating of current is necessary for PLT5BP series. Please apply the derating curve shown in chart according to the operating temperature.

Derating of Rated Current

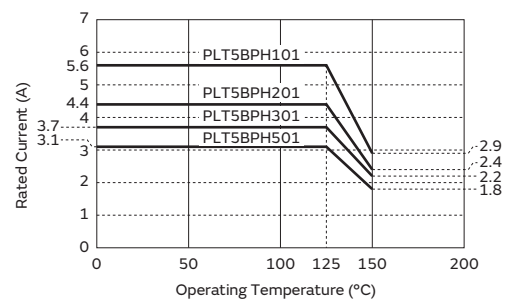

Common mode choke coil/Common mode noise filter

PLT10HH Series

Appearance/Dimensions

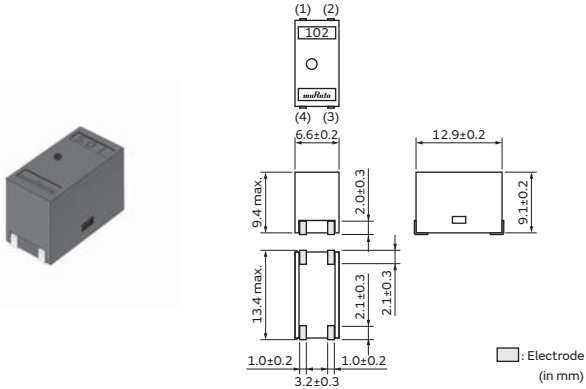

Packaging

| Code | Packaging | Minimum Quantity |
|------|----------------------|------------------|
| K | ø330mm Embossed Tape | 500 |
| L | ø180mm Embossed Tape | 125 |
| B | Bulk(Bag) | 50 |

Equivalent Circuit

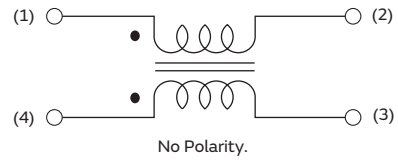

Rated Value (□: packaging code)

| Part Number | Common Mode Impedance at 10MHz | Common Mode Inductance | Rated Current | Rated Voltage | Insulation Resistance (Min.) | Withstanding Voltage | DC Resistance | Operating Temp. Range |
|------------------|--------------------------------|------------------------|---------------|---------------|------------------------------|----------------------|---------------|-----------------------|
| PLT10HH450180PN□ | 45Ω(Typ.) | 0.8μHmin. | 18A | 300Vdc | 10MΩ | 750Vdc | 1.3mΩ±0.5mΩ | -55°C to 125°C |
| PLT10HH101150PN□ | 100Ω(Typ.) | 2.0μHmin. | 15A | 300Vdc | 10MΩ | 750Vdc | 1.8mΩ±0.5mΩ | -55°C to 125°C |
| PLT10HH401100PN□ | 400Ω(Typ.) | 6μHmin. | 10A | 100Vdc | 10MΩ | 250Vdc | 3.6mΩ±0.5mΩ | -55°C to 125°C |
| PLT10HH501100PN□ | 500Ω(Typ.) | 9μHmin. | 10A | 100Vdc | 10MΩ | 250Vdc | 3.6mΩ±0.5mΩ | -55°C to 105°C |
| PLT10HH9016R0PN□ | 900Ω(Typ.) | 14μHmin. | 6A | 100Vdc | 10MΩ | 250Vdc | 8.0mΩ±0.5mΩ | -55°C to 125°C |
| PLT10HH1026R0PN□ | 1000Ω(Typ.) | 20μHmin. | 6A | 100Vdc | 10MΩ | 250Vdc | 8.0mΩ±0.5mΩ | -55°C to 105°C |

Operating temperature should include self-temperature rise.

Z-f characteristics: PLT10HH series

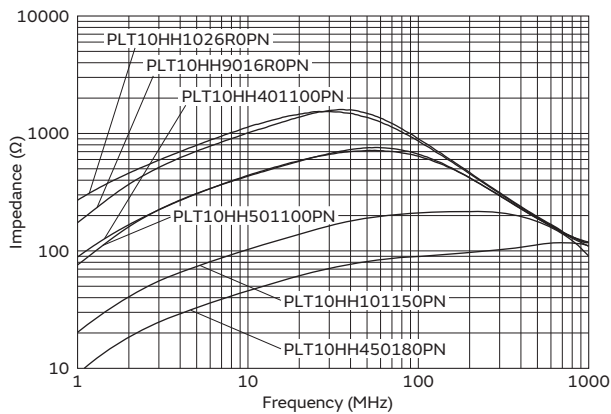

Derating of Rated Current

In operating temperature exceeding +65°C, derating of current is necessary for PLT10H series. Please apply the derating curve shown in chart according to the operating temperature.

Derating of Rated Current

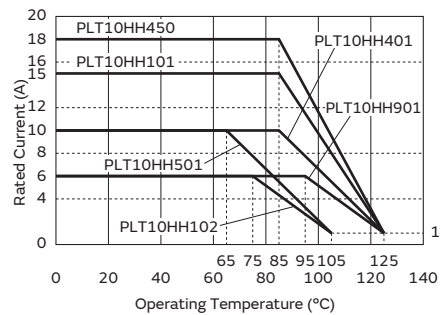

Common Mode Choke Coil/Common Mode Noise Filter (DLM/DLP/DLW/NFP) ⚠️Caution/Notice

⚠️Caution

Rating

Do not use products beyond the rated current and rated voltage as this may create excessive heat and deteriorate the insulation resistance. Be sure to provide an appropriate fail-safe function on your product to prevent secondary damage that may be caused by the abnormal function or the failure our product.

Soldering and Mounting

1. Self-heating

Please pay special attention when mounting chip common mode choke coils DLW5 series in close proximity to other products that radiate heat. The heat generated by other products may deteriorate the insulation resistance and cause excessive heat in this component.

2. Mounting Direction

Mount Chip Common Mode Choke Coils in the right direction. The wrong direction, which is 90 degrees rotated from the right direction, causes not only open or short circuit but also flames or other serious problems.

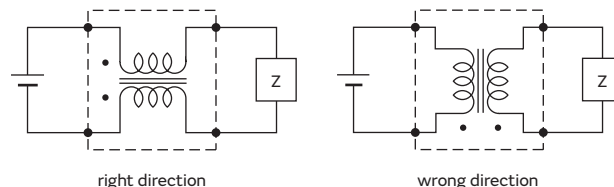

Notice

Storage and Operating Conditions

<Operating Environment>

Do not use products in a corrodible atmosphere such as acidic gases, alkaline gases, chlorine, sulfur gases, organic gases (a sea breeze, Cl₂, H₂S, NH₃, SO₂, NO₂, etc.).

Do not use products in an environment close to an organic solvent.

<Storage and Handling Requirements>

1. Storage Period

DLM11G series should be used within 6 months; the other series should be used within 12 months. Solderability should be checked if this period is exceeded.

2. Storage Conditions

- (1) Storage temperature: -10 to +40°C
Relative humidity: 15 to 85%
Avoid sudden changes in temperature and humidity.
- (2) Do not store products in a chemical atmosphere such as chlorine gas, acid or sulfide gas.

Notice (Soldering and Mounting)

1. Cleaning

Failure and degradation of a product can be caused by the cleaning method. When you clean in conditions that are not in the mounting information, please contact Murata engineering.

2. Soldering

Reliability decreases with improper soldering methods. Please solder by the standard soldering conditions shown in the mounting information.

3. Other

Noise suppression levels resulting from Murata's EMI suppression filters EMIFIL® may vary, depending on the circuits and ICs used, type of noise, mounting pattern, mounting location, and other operating conditions. Be sure to check and confirm in advance the noise suppression effect of each filter, in actual circuits, etc. before applying the filter in a commercial-purpose equipment design.

Continued on the following page. ↗

Common Mode Choke Coil/Common Mode Noise Filter (DLM/DLP/DLW/NFP) ⚠Caution/Notice

Continued from the preceding page. ↘

Handling

1. Resin Coating (except for DLW Series)

Using resin for coating/molding products may affect the product's performance.

So please pay careful attention in selecting resin.

Prior to use, please make a reliability evaluation with the product mounted in your application set.

2. Resin Coating (DLW Series)

The impedance value may change due to high cure-stress of resin to be used for coating/molding products. An open circuit issue may occur by mechanical stress caused by the resin, amount/cured shape of resin, or operating conditions, etc. Some resins containing impurities or chloride may possibly generate chlorine by hydrolysis under some operating conditions, causing corrosion of the coil wire and leading to an open circuit.

Therefore, please pay careful attention to selecting the resin for coating/molding the products. Prior to using the coating resin, please ensure that no reliability issue is observed by evaluating products mounted on your board.

3. Caution for Use (DLW Series)

When you hold products with a tweezer, please hold by the sides. Sharp materials, such as a pair of tweezers, should not touch the winding portion to prevent breaking the wire. To prevent breaking the core, mechanical shock should not be applied to the products mounted on the board.

4. Brushing

When you clean the neighborhood of products such as connector pins, cleaning brush bristles should not be touched to the winding portion of this product to prevent breaking the wire.

5. Handling of Substrates

After mounting products on a substrate, do not apply any stress to the product by bending or twisting the substrate when cropping the substrate, inserting and removing a connector from the substrate or tightening a screw to the substrate. Excessive mechanical stress may cause cracking in the product.

Bending

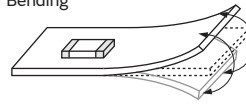

Twisting

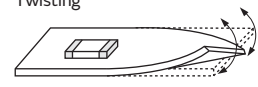

Common Mode Choke Coil (PLT) ⚠Caution/Notice

⚠Caution

Rating

1. Do not use products beyond the rated current and rated voltage as this may create excessive heat and deteriorate the insulation resistance.
2. Be sure to provide an appropriate fail-safe function on your product to prevent secondary damage that may be caused by the abnormal function or the failure our product.

Soldering and Mounting

1. Self-heating
 Please pay special attention when mounting chip common mode choke coils in close proximity to other products that radiate heat.
 The heat generated by other products may deteriorate the insulation resistance and cause excessive heat in this component.
2. Mounting Direction
 Mount Chip Common Mode Choke Coils in the right

direction. The wrong direction, which is 90 degrees rotated from the right direction, causes not only open or short circuit but also flames or other serious problems.

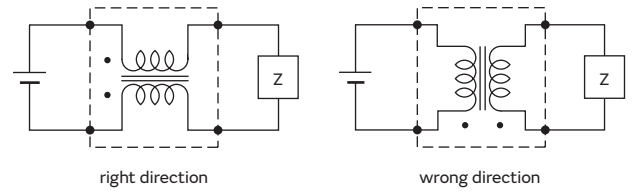

Notice

Storage and Operating Conditions

- <Operating Environment>
 Do not use products in a chemical atmosphere such as chlorine gas, acid or sulfide gas.
 Do not use products in an environment close to an organic solvent.
- <Storage and Handling Requirements>
1. Storage Period
 PLT10H series should be used within 12 months.

- Solderability should be checked if this period is exceeded.
2. Storage Conditions
 - (1) Storage temperature: -10 to +40°C
 Relative humidity: 15 to 85%
 Avoid sudden changes in temperature and humidity.
 - (2) Do not store products in a chemical atmosphere such as chlorine gas, acid or sulfide gas.

Notice (Soldering and Mounting)

1. Cleaning
 Failure and degradation of a product can be caused by the cleaning method. When you clean in conditions that are not in the mounting information, please contact Murata engineering.
2. Soldering
 Reliability decreases with improper soldering methods. Please solder by the standard soldering conditions shown in the mounting information.
3. Other
 Noise suppression levels resulting from Murata's EMI suppression filters EMIFIL® may vary, depending on the circuits and ICs used, type of noise, mounting pattern, mounting location, and other operating conditions. Be sure to check and confirm in advance the noise suppression effect of each filter, in actual circuits, etc. before applying the filter in a commercial-purpose equipment design.

Handling

1. Handling of Substrates
 After mounting products on a substrate, do not apply any stress to the product by bending or twisting the substrate when cropping the substrate, inserting and removing a connector from the substrate or tightening a screw to the substrate.

Excessive mechanical stress may cause cracking in the product.



Common Mode Choke Coil/Common Mode Noise Filter (DLM/DLP/DLW/NFP) Soldering and Mounting

1. Standard Land Pattern Dimensions

Land Pattern + Solder Resist
 Land Pattern
 Solder Resist
 (in mm)

| Series | Standard Land Dimensions | | | | | | | | | | | | | | | | | |
|--|----------------------------|---|---------------|--------|---|---|---|---|----------|-----|-----|-----|-----|---------|-----|-----|-----|-----|
| DLM0QS DLM0NS DLM11G DLM11S DLP0QS DLP0NS DLP11R DLP11S DLP11T DLP31S DLP1ND DLP2AD DLP31D DLW21H DLW21S DLW31SN NFP0QH NFP0QS DLW44 DLW5A DLW5B | ●Reflow and Flow DLP31S | | | | | | | | | | | | | | | | | |
| | | | DLP31D | | | | | | | | | | | | | | | |
| | | | | | | | | | | | | | | | | | | |
| | ●Reflow Soldering | | | | | | | | | | | | | | | | | |
| | DLM0QS/DLP0QS/NFP0QH/0QS | | DLM0NS/DLP0NS | | | | | | | | | | | | | | | |
| | | | | | | | | | | | | | | | | | | |
| | DLP11S/DLM11S | | DLP11R/11T | | | | | | | | | | | | | | | |
| | | | | | | | | | | | | | | | | | | |
| | DLP1ND | | DLP2AD | | | | | | | | | | | | | | | |
| | | | | | | | | | | | | | | | | | | |
| DLM11G | | DLW21S/21H/31SN | | | | | | | | | | | | | | | | |
| | | | | | | | | | | | | | | | | | | |
| DLW44 | | DLW5A/5B (except for DLW5AT_MQ2) | | | | | | | | | | | | | | | | |
| | | | | | | | | | | | | | | | | | | |
| | | <table border="1" style="margin: auto;"> <thead> <tr> <th>Series</th> <th>a</th> <th>b</th> <th>c</th> <th>d</th> </tr> </thead> <tbody> <tr> <td>DLW21S/H</td> <td>0.8</td> <td>2.6</td> <td>0.4</td> <td>1.2</td> </tr> <tr> <td>DLW31SN</td> <td>1.6</td> <td>3.7</td> <td>0.4</td> <td>1.6</td> </tr> </tbody> </table> | | Series | a | b | c | d | DLW21S/H | 0.8 | 2.6 | 0.4 | 1.2 | DLW31SN | 1.6 | 3.7 | 0.4 | 1.6 |
| Series | a | b | c | d | | | | | | | | | | | | | | |
| DLW21S/H | 0.8 | 2.6 | 0.4 | 1.2 | | | | | | | | | | | | | | |
| DLW31SN | 1.6 | 3.7 | 0.4 | 1.6 | | | | | | | | | | | | | | |
| *1: If the pattern is made wider than 1.2mm (DLW21) / 1.6mm (DLW31S) it may result in components turning around, because melting speed is different. In the worst case, short circuit between lines may occur. *2: If the pattern is made with less than specified dimensions, in the worst case, short circuit between lines may occur due to spread of soldering paste or mount placing accuracy. *3: If the pattern is made wider than 0.8mm (DLW21) / 1.6mm (DLW31SN), the bending strength will be reduced. Do not use gild pattern; excess soldering heat may dissolve the metal of a copper wire. | | | | | | | | | | | | | | | | | | |

Continued on the following page. ➔

Common Mode Choke Coil/Common Mode Noise Filter (DLM/DLP/DLW/NFP) Soldering and Mounting

Continued from the preceding page. ↘

| Series | Standard Land Dimensions | |
|------------|--------------------------------------|------------------------------------|
| | ●Reflow Soldering Chip Mounting Side | ●Flow Soldering Chip Mounting Side |
| DLW5AT_MQ2 | <p>DLW5AT_MQ2</p> | <p>DLW5AT_MQ2</p> |

● PCB Warping

PCB should be designed so that products are not subjected to mechanical stress caused by warping the board.

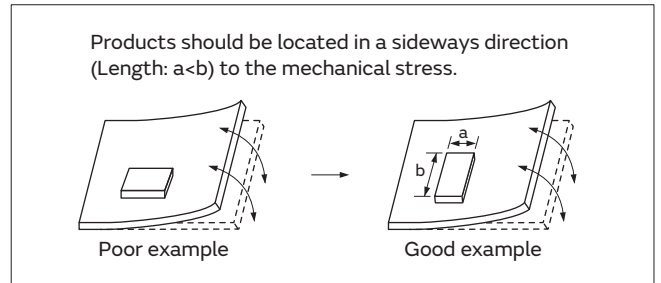

2. Solder Paste Printing and Adhesive Application

When reflow soldering the chip common mode choke coils, the printing must be conducted in accordance with the following cream solder printing conditions.

If too much solder is applied, the chip will be prone to damage by mechanical and thermal stress from the PCB and may crack.

Standard land dimensions should be used for resist and copper foil patterns.

When flow soldering the chip common mode choke coils, apply the adhesive in accordance with the following conditions.

If too much adhesive is applied, it may overflow into the land or termination areas and yield poor solderability.

In contrast, if insufficient adhesive is applied, or if the adhesive is not sufficiently hardened, then the chip may become detached during the flow soldering process.

Continued on the following page. ↗

Common Mode Choke Coil/Common Mode Noise Filter (DLM/DLP/DLW/NFP) Soldering and Mounting

Continued from the preceding page. ↘

(in mm)

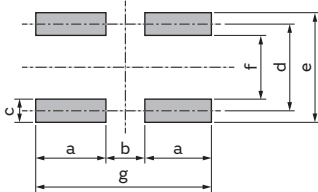
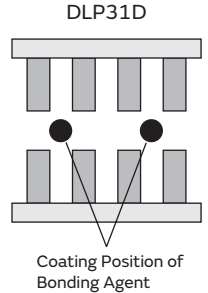
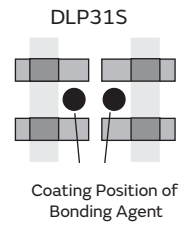
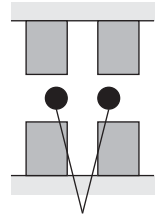
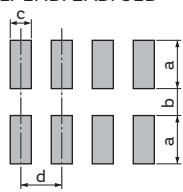
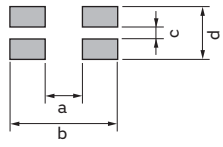
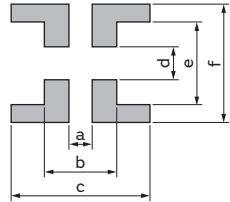
| Series | Solder Paste Printing | Adhesive Application | | | | | | | | | | | | | | | | | | | | | | | | | | | | | | | | | | | | | | | | | | | | | | | | | | | | | | | | |
|--------------------------|---|---|--------|------|------|------|----------|--------|-------|--------------------------|-----|--------|--------|------|------|----------|-----|---------------|-----|-----|-----|-----|---|---|---|--------|---|-----|---|---|-----|-----|-----|---------------|-----|------|-----|------|---|---|---|----------|-----|------|-----|------|---|---|---|--------|-----|-----|-----|-----|---|---|---|---|
| DLM DLP DLW NFP | <p>●Guideline of solder paste thickness: 80-100µm: DLP0QS 100-150µm: DLM0QS/ONS/DLM11G/11S, DLPONS/11R/11S/11T/1ND/2AD, DLW21H/21S/31S, NFP0QH/0QS 150-200µm: DLP31D/31S, DLW5A/5B</p> <p>*Solderability is subject to reflow conditions and thermal conductivity. Please ensure that your product has been evaluated in view of your specifications with our product being mounted to your product.</p> <p>DLM0QS/ONS/11G/11S/DLP0QS/ONS/11R/11S/11T/31S/NFP0QH/0QS</p>  <table border="1"> <thead> <tr> <th>Series</th> <th>a</th> <th>b</th> <th>c</th> <th>d</th> <th>e</th> <th>f</th> <th>g</th> </tr> </thead> <tbody> <tr> <td>DLM0QS/DLP0QS/NFP0QH/0QS</td> <td>0.3</td> <td>0.2</td> <td>0.23</td> <td>-</td> <td>0.71</td> <td>-</td> <td>-</td> </tr> <tr> <td>DLMONS/DLPONS</td> <td>0.3</td> <td>0.3</td> <td>0.3</td> <td>0.5</td> <td>-</td> <td>-</td> <td>-</td> </tr> <tr> <td>DLM11G</td> <td>-</td> <td>0.5</td> <td>-</td> <td>-</td> <td>1.1</td> <td>0.3</td> <td>1.5</td> </tr> <tr> <td>DLM11S/DLP11S</td> <td>0.7</td> <td>0.55</td> <td>0.3</td> <td>0.55</td> <td>-</td> <td>-</td> <td>-</td> </tr> <tr> <td>DLP11R/T</td> <td>0.5</td> <td>0.55</td> <td>0.3</td> <td>0.55</td> <td>-</td> <td>-</td> <td>-</td> </tr> <tr> <td>DLP31S</td> <td>1.0</td> <td>0.6</td> <td>0.7</td> <td>2.1</td> <td>-</td> <td>-</td> <td>-</td> </tr> </tbody> </table> | Series | a | b | c | d | e | f | g | DLM0QS/DLP0QS/NFP0QH/0QS | 0.3 | 0.2 | 0.23 | - | 0.71 | - | - | DLMONS/DLPONS | 0.3 | 0.3 | 0.3 | 0.5 | - | - | - | DLM11G | - | 0.5 | - | - | 1.1 | 0.3 | 1.5 | DLM11S/DLP11S | 0.7 | 0.55 | 0.3 | 0.55 | - | - | - | DLP11R/T | 0.5 | 0.55 | 0.3 | 0.55 | - | - | - | DLP31S | 1.0 | 0.6 | 0.7 | 2.1 | - | - | - | <p>DLP31S/DLP31D/ DLW5AT_MQ2 Apply 0.3mg of bonding agent at each chip.</p>  <p>Coating Position of Bonding Agent</p>  <p>Coating Position of Bonding Agent</p>  <p>Coating Position of Bonding Agent</p> |
| | Series | a | b | c | d | e | f | g | | | | | | | | | | | | | | | | | | | | | | | | | | | | | | | | | | | | | | | | | | | | | | | | | | |
| | DLM0QS/DLP0QS/NFP0QH/0QS | 0.3 | 0.2 | 0.23 | - | 0.71 | - | - | | | | | | | | | | | | | | | | | | | | | | | | | | | | | | | | | | | | | | | | | | | | | | | | | | |
| | DLMONS/DLPONS | 0.3 | 0.3 | 0.3 | 0.5 | - | - | - | | | | | | | | | | | | | | | | | | | | | | | | | | | | | | | | | | | | | | | | | | | | | | | | | | |
| | DLM11G | - | 0.5 | - | - | 1.1 | 0.3 | 1.5 | | | | | | | | | | | | | | | | | | | | | | | | | | | | | | | | | | | | | | | | | | | | | | | | | | |
| | DLM11S/DLP11S | 0.7 | 0.55 | 0.3 | 0.55 | - | - | - | | | | | | | | | | | | | | | | | | | | | | | | | | | | | | | | | | | | | | | | | | | | | | | | | | |
| | DLP11R/T | 0.5 | 0.55 | 0.3 | 0.55 | - | - | - | | | | | | | | | | | | | | | | | | | | | | | | | | | | | | | | | | | | | | | | | | | | | | | | | | |
| | DLP31S | 1.0 | 0.6 | 0.7 | 2.1 | - | - | - | | | | | | | | | | | | | | | | | | | | | | | | | | | | | | | | | | | | | | | | | | | | | | | | | | |
| | | <p>DLP1ND/2AD/31D</p>  <table border="1"> <thead> <tr> <th>Series</th> <th>a</th> <th>b</th> <th>c</th> <th>d</th> </tr> </thead> <tbody> <tr> <td>DLP1ND</td> <td>0.3</td> <td>0.3</td> <td>0.2</td> <td>0.4</td> </tr> <tr> <td>DLP2AD</td> <td>0.55</td> <td>0.4</td> <td>0.25</td> <td>0.5</td> </tr> <tr> <td>DLP31D</td> <td>1.0</td> <td>0.8</td> <td>0.4</td> <td>0.8</td> </tr> </tbody> </table> | Series | a | b | c | d | DLP1ND | 0.3 | 0.3 | 0.2 | 0.4 | DLP2AD | 0.55 | 0.4 | 0.25 | 0.5 | DLP31D | 1.0 | 0.8 | 0.4 | 0.8 | | | | | | | | | | | | | | | | | | | | | | | | | | | | | | | | | | | | |
| | Series | a | b | c | d | | | | | | | | | | | | | | | | | | | | | | | | | | | | | | | | | | | | | | | | | | | | | | | | | | | | | |
| DLP1ND | 0.3 | 0.3 | 0.2 | 0.4 | | | | | | | | | | | | | | | | | | | | | | | | | | | | | | | | | | | | | | | | | | | | | | | | | | | | | | |
| DLP2AD | 0.55 | 0.4 | 0.25 | 0.5 | | | | | | | | | | | | | | | | | | | | | | | | | | | | | | | | | | | | | | | | | | | | | | | | | | | | | | |
| DLP31D | 1.0 | 0.8 | 0.4 | 0.8 | | | | | | | | | | | | | | | | | | | | | | | | | | | | | | | | | | | | | | | | | | | | | | | | | | | | | | |
| | <p>DLW21S/21H/31S</p>  <table border="1"> <thead> <tr> <th>Series</th> <th>a</th> <th>b</th> <th>c</th> <th>d</th> </tr> </thead> <tbody> <tr> <td>DLW21S/H</td> <td>0.8</td> <td>2.6</td> <td>0.5</td> <td>1.2</td> </tr> <tr> <td>DLW31S</td> <td>1.6</td> <td>3.7</td> <td>0.4</td> <td>1.6</td> </tr> </tbody> </table> | Series | a | b | c | d | DLW21S/H | 0.8 | 2.6 | 0.5 | 1.2 | DLW31S | 1.6 | 3.7 | 0.4 | 1.6 | | | | | | | | | | | | | | | | | | | | | | | | | | | | | | | | | | | | | | | | | | |
| Series | a | b | c | d | | | | | | | | | | | | | | | | | | | | | | | | | | | | | | | | | | | | | | | | | | | | | | | | | | | | | | |
| DLW21S/H | 0.8 | 2.6 | 0.5 | 1.2 | | | | | | | | | | | | | | | | | | | | | | | | | | | | | | | | | | | | | | | | | | | | | | | | | | | | | | |
| DLW31S | 1.6 | 3.7 | 0.4 | 1.6 | | | | | | | | | | | | | | | | | | | | | | | | | | | | | | | | | | | | | | | | | | | | | | | | | | | | | | |
| | <p>DLW44/5A/5B</p>  <table border="1"> <thead> <tr> <th>Series</th> <th>a</th> <th>b</th> <th>c</th> <th>d</th> <th>e</th> <th>f</th> </tr> </thead> <tbody> <tr> <td>DLW44</td> <td>0.8</td> <td>2.5</td> <td>5.6</td> <td>0.9</td> <td>1.9</td> <td>3.9</td> </tr> <tr> <td>DLW5A/5B</td> <td>0.9</td> <td>2.9</td> <td>5.5</td> <td>1.3</td> <td>3.3</td> <td>4.7</td> </tr> </tbody> </table> | Series | a | b | c | d | e | f | DLW44 | 0.8 | 2.5 | 5.6 | 0.9 | 1.9 | 3.9 | DLW5A/5B | 0.9 | 2.9 | 5.5 | 1.3 | 3.3 | 4.7 | | | | | | | | | | | | | | | | | | | | | | | | | | | | | | | | | | | | |
| Series | a | b | c | d | e | f | | | | | | | | | | | | | | | | | | | | | | | | | | | | | | | | | | | | | | | | | | | | | | | | | | | | |
| DLW44 | 0.8 | 2.5 | 5.6 | 0.9 | 1.9 | 3.9 | | | | | | | | | | | | | | | | | | | | | | | | | | | | | | | | | | | | | | | | | | | | | | | | | | | | |
| DLW5A/5B | 0.9 | 2.9 | 5.5 | 1.3 | 3.3 | 4.7 | | | | | | | | | | | | | | | | | | | | | | | | | | | | | | | | | | | | | | | | | | | | | | | | | | | | |

Continued on the following page. ↗

Common Mode Choke Coil/Common Mode Noise Filter (DLM/DLP/DLW/NFP) Soldering and Mounting

Continued from the preceding page. ↘

3. Standard Soldering Conditions

(1) Soldering Methods

Use flow and reflow soldering methods only.
 Use standard soldering conditions when soldering chip common mode choke coils.
 In cases where several different parts are soldered, each having different soldering conditions, use those conditions requiring the least heat and minimum time.

Solder: Use Sn-3.0Ag-0.5Cu solder. Use of Sn-Zn based solder will deteriorate performance of products.
 If using DLP/DLM series with Sn-Zn based solder, please contact Murata in advance.

Flux:

- Use rosin-based flux.
 In case of DLW21/31 series, use rosin-based flux with converting chlorine content of 0.06 to 0.1wt%.
 In case of using RA type solder, products should be cleaned completely with no residual flux.
- Do not use strong acidic flux (with chlorine content exceeding 0.20wt%)
- Do not use water-soluble flux.

For additional mounting methods, please contact Murata.

(2) Soldering Profile

● Flow Soldering Profile (Sn-3.0Ag-0.5Cu Solder)

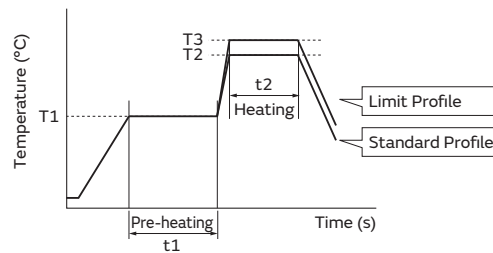

| Series | Pre-heating | | Standard Profile | | | Limit Profile | | |
|--------------------------|-------------|-----------|------------------|-----------|---------------|---------------|-----------|---------------|
| | Temp. (T1) | Time (t1) | Heating | | Cycle of Flow | Heating | | Cycle of Flow |
| | | | Temp. (T2) | Time (t2) | | Temp. (T3) | Time (t2) | |
| DLW5AT_MQ2 DLP31D/31S | 150°C | 60s min. | 250°C | 4 to 6s | 2 times max. | 265±3°C | 5s max. | 2 times max. |

● Reflow Soldering Profile (Sn-3.0Ag-0.5Cu Solder)

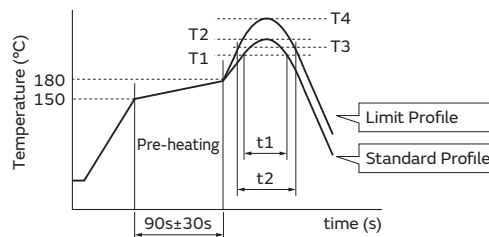

| Series | Standard Profile | | | | Limit Profile | | | |
|----------------------------|------------------|-----------|-----------------------|-----------------|---------------|-----------|-----------------------|-----------------|
| | Heating | | Peak Temperature (T2) | Cycle of Reflow | Heating | | Peak Temperature (T4) | Cycle of Reflow |
| | Temp. (T1) | Time (t1) | | | Temp. (T3) | Time (t2) | | |
| DLM/DLP DLW21/31 NFP | 220°C min. | 30 to 60s | 245±3°C | 2 times max. | 230°C min. | 60s max. | 260°C/10s | 2 times max. |
| DLW44/5A/5B | 220°C min. | 30 to 60s | 250±3°C | 2 times max. | 230°C min. | 60s max. | 260°C/10s | 2 times max. |

Continued on the following page. ↗

Common Mode Choke Coil/Common Mode Noise Filter (DLM/DLP/DLW/NFP) Soldering and Mounting

Continued from the preceding page. ↘

(3) Reworking with a soldering Iron

The following conditions must be strictly followed when using a soldering iron.

Pre-heating: 150°C 60s min.

Soldering iron power output / Tip diameter:

30W max. / \varnothing 3mm max.

Temperature of soldering iron tip / Soldering time /

Times:

350°C max. / 3-4s / 2 times*¹

*¹ DLM0Q/0N,DLP0QS/0NS,DLP11S/11T/1ND

DLP2AD: 380°C max. / 3-4s / 2 times

NFP0QH/0QS cannot be reworked with a soldering iron.

Do not allow the tip of the soldering iron to directly contact the chip.

For additional methods of reworking with a soldering iron, please contact Murata engineering.

4. Cleaning

The following conditions should be observed when cleaning chip EMI filters.

(1) Cleaning temperature: 60°C max. (40°C max. for alcohol type cleaner)

(2) Ultrasonic

Output: 20W/liter max.

Duration: 5 minutes max.

Frequency: 28 to 40kHz

(3) Cleaning agent

The following cleaning agents have been tested on the individual components. Evaluation of final assembly should be completed prior to production.

Do not clean DLW (except for DLW21H) series.

Before cleaning, please contact Murata engineering.

(a) Alcohol cleaning agent

Isopropyl alcohol (IPA)

(b) Aqueous cleaning agent

Pine Alpha ST-100S

(4) Ensure that flux residue is completely removed.

The component should be thoroughly dried after the aqueous agent has been removed with deionized water.

Common Mode Choke Coil (PLT) Soldering and Mounting

1. Standard Land Pattern Dimensions

(in mm)

| Series | Standard Land Dimensions | |
|--------------------------------|--------------------------|---------------|
| PLT5BP PLT10H | ●Reflow Soldering | |
| | <p>PLT5BP</p> | <p>PLT10H</p> |
| | | |

● PCB Warping

PCB should be designed so that products are not subjected to mechanical stress caused by warping the board.

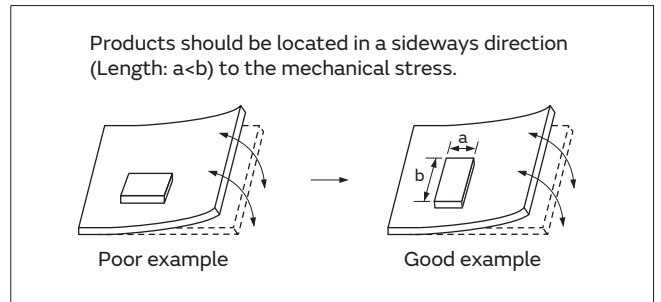

2. Solder Paste Printing and Adhesive Application

When reflow soldering the chip common mode choke coils, the printing must be conducted in accordance with the following cream solder printing conditions.

If too much solder is applied, the chip will be prone to damage by mechanical and thermal stress from the PCB and may crack.

Standard land dimensions should be used for resist and copper foil patterns.

When flow soldering the chip common mode choke coils, apply the adhesive in accordance with the following conditions.

If too much adhesive is applied, it may overflow into the land or termination areas and yield poor solderability. In contrast, if insufficient adhesive is applied, or if the adhesive is not sufficiently hardened, then the chip may become detached during the flow soldering process.

| Series | Solder Paste Printing |
|--------------------------------|---|
| PLT5BP PLT10H | ●Guideline of solder paste thickness: 150μm: PLT5BP 150-200μm: PLT10H For the solder paste printing pattern, use standard land dimensions. *Solderability is subject to reflow conditions and thermal conductivity. Please ensure that your product has been evaluated in view of your specifications with our product being mounted to your product. |

Continued on the following page. ↗

Common Mode Choke Coil (PLT) Soldering and Mounting

Continued from the preceding page. ↘

3. Standard Soldering Conditions

(1) Soldering Methods

Use reflow soldering methods only.
 Use standard soldering conditions when soldering chip common mode choke coils.
 In cases where several different parts are soldered, each having different soldering conditions, use those conditions requiring the least heat and minimum time.

Solder: Use Sn-3.0Ag-0.5Cu solder. Use of Sn-Zn based solder will deteriorate performance of products.

Flux:

- Use rosin-based flux.
- Do not use strong acidic flux (with chlorine content exceeding 0.20wt%)
- Do not use water-soluble flux.

For additional mounting methods, please contact Murata.

(2) Soldering Profile

- Reflow Soldering Profile (Sn-3.0Ag-0.5Cu Solder)

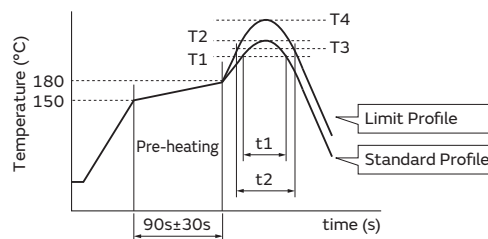

| Series | Standard Profile | | | | Limit Profile | | | |
|--------|------------------|-----------|-----------------------|-----------------|---------------|-----------|-----------------------|-----------------|
| | Heating | | Peak Temperature (T2) | Cycle of Reflow | Heating | | Peak Temperature (T4) | Cycle of Reflow |
| | Temp. (T1) | Time (t1) | | | Temp. (T3) | Time (t2) | | |
| PLT5BP | 220°C min. | 30 to 60s | 245±3°C | 2 times | 240°C min. | 30s max. | 260°C/10s | 2 times |
| PLT10H | 220°C min. | 30 to 60s | 250±3°C | 2 times max. | 230°C min. | 60s max. | 260°C/10s | 2 times max. |

(3) Reworking with a soldering Iron

The following conditions must be strictly followed when using a soldering iron.

Pre-heating: 150°C 60s min.

Soldering iron power output / Tip diameter:

30W max. / ø3mm max.: PLT5BP

80W max. / ø3mm max.: PLT10H

Temperature of soldering iron tip / Soldering time / Times:

350°C max. / 3 to 4s / 2 times: PLT5BP

400°C max. / 5s / 2 times: PLT10H

Do not allow the tip of the soldering iron to directly contact the chip.

For additional methods of reworking with a soldering iron, please contact Murata engineering.

4. Cleaning

Do not clean after soldering. If cleaning, please contact us.

Common Mode Choke Coil/Common Mode Noise Filter (DLM/DLP/DLW/NFP) Packaging

Minimum Quantity and Dimensions of 8mm Width Paper / Embossed Tape

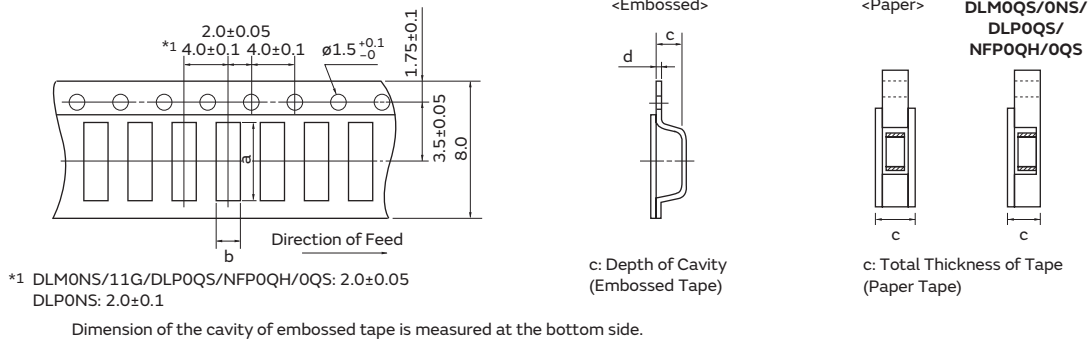

| Part Number | Dimensions | | | | Minimum Qty. (pcs.) | | | | |
|---------------|------------|------|-----------|------|---------------------|---------------|-------------|---------------|------|
| | | | | | ø180mm Reel | | ø330mm Reel | | Bulk |
| | a | b | c | d | Paper Tape | Embossed Tape | Paper Tape | Embossed Tape | |
| DLM0QS/DLP0QS | 0.73 | 0.6 | 0.55 max. | - | 15000 | - | - | - | 500 |
| DLMONS | 0.97 | 0.77 | 0.8 max. | - | 10000 | - | - | - | 500 |
| DLM11G | 1.45 | 1.2 | 0.8 max. | - | 10000 | - | - | - | 1000 |
| DLM11S | 1.4 | 1.15 | 0.65 | 0.25 | - | 4000 | - | - | 500 |
| DLPONS | 0.95 | 0.75 | 0.55 | 0.25 | - | 10000 | - | - | 500 |
| DLP11R | 1.4 | 1.15 | 0.7 | 0.25 | - | 4000 | - | - | 500 |
| DLP11S | 1.4 | 1.2 | 0.98 | 0.25 | - | 3000 | - | - | 500 |
| DLP11T | 1.35 | 1.1 | 0.45 | 0.25 | - | 5000 | - | - | 500 |
| DLP31S/31D | 3.5 | 1.9 | 1.3 | 0.25 | - | 3000 | - | - | 500 |
| DLP1ND | 1.7 | 0.84 | 0.57 | 0.25 | - | 5000 | - | - | 500 |
| DLP2AD | 2.2 | 1.2 | 0.98 | 0.25 | - | 3000 | - | - | 500 |
| DLW21H | 2.3 | 1.55 | 1.1 | 0.25 | - | 3000 | - | - | 500 |
| DLW21SN | 2.25 | 1.45 | 1.4 | 0.25 | - | 2000 | - | - | 500 |
| DLW31S | 3.6 | 2.0 | 2.1 | 0.3 | - | 2000 | - | - | 500 |
| NFP0QH/OQS | 0.73 | 0.6 | 0.43 max. | - | 15000 | - | - | - | 500 |

(in mm)

Minimum Quantity and Dimensions of 12mm Width Embossed Tape

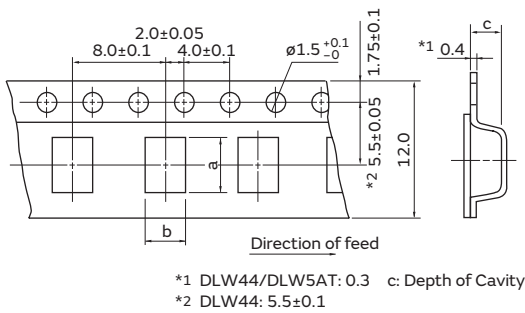

| Part Number | Dimensions | | | Minimum Qty. (pcs.) | | |
|-------------|------------|-----|-----|---------------------|-------------|------|
| | a | b | c | ø180mm Reel | ø330mm Reel | Bulk |
| DLW44S | 4.3 | 4.3 | 1.7 | 1000 | 3500 | 100 |
| DLW5AH | 5.4 | 4.1 | 4.4 | 400 | 1500 | 100 |
| DLW5AT | 5.4 | 4.1 | 2.7 | 700 | 2500 | 100 |
| DLW5BS | 5.5 | 5.4 | 4.7 | 400 | 1500 | 100 |
| DLW5BT | 5.5 | 5.5 | 2.7 | 700 | 2500 | 100 |

(in mm)

"Minimum Quantity" means the number of units of each delivery or order. The quantity should be an integral multiple of the "Minimum Quantity."

Common Mode Choke Coil (PLT) Packaging

Minimum Quantity and Dimensions of 12mm Width Embossed Tape

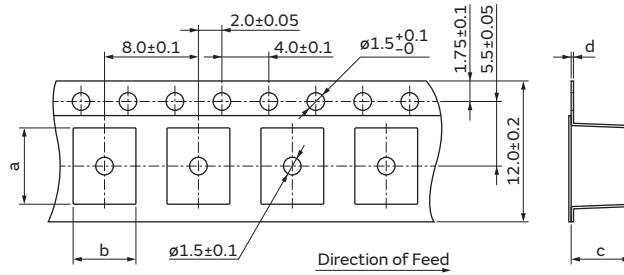

Dimension of the cavity is measured at the bottom side.

| Part Number | Dimensions | | | | Minimum Qty. (pcs.) | | |
|-------------|------------|------|-----|-----|---------------------|-------------|------|
| | a | b | c | d | ø180mm Reel | ø330mm Reel | Bulk |
| PLT5BP | 6.5 | 5.35 | 5.1 | 0.4 | 300 | - | 50 |

(in mm)

Minimum Quantity and Dimensions of 24mm Width Embossed Tape

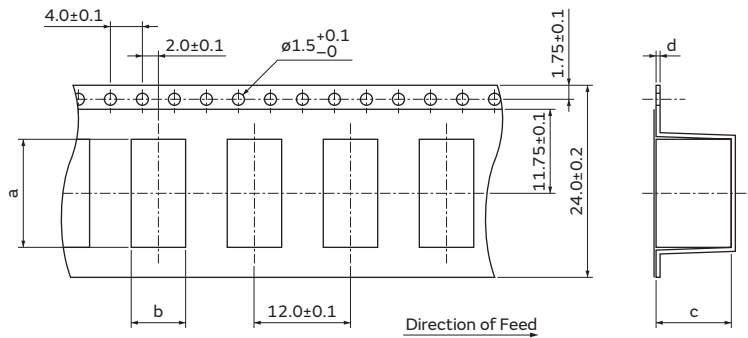

Dimension of the cavity is measured at the bottom side.

| Part Number | Dimensions | | | | Minimum Qty. (pcs.) | | |
|-------------|------------|-----|-----|-----|---------------------|-------------|------|
| | a | b | c | d | ø180mm Reel | ø330mm Reel | Bulk |
| PLT10H | 13.5 | 6.8 | 9.4 | 0.5 | 125 | 500 | 50 |

(in mm)

Block Type EMIFIL® BNX Series

| | |
|--------------------------------------|------|
| Series Lineup/Function Example | p254 |
| Product Detail | p256 |
| ⚠Caution/Notice | p260 |
| Soldering and Mounting | p262 |
| Packaging | p266 |

Block Type EMIFIL[®] (BNX) Series Lineup / Function Example

| Type | Part Number | Thickness (mm) | Rated Voltage | Effective Frequency Range | Rated Current | Comments |
|--|--------------------|----------------|---------------|---------------------------|---------------|----------------------|
| SMD Type for Power Lines | p256 BNX022-01□ | 3.1 | 50Vdc | 1MHz to 1GHz:35dB min. | 20A | |
| | BNX023-01□ | 3.1 | 100Vdc | 1MHz to 1GHz:35dB min. | 20A | |
| | BNX028-01□ | 3.5 | 16Vdc | 30kHz to 1GHz:35dB min. | 20A | |
| | BNX029-01□ | 3.5 | 6.3Vdc | 15kHz to 1GHz:35dB min. | 20A | |
| | BNX024H01□ | 3.5 | 50Vdc | 100kHz to 1GHz:35dB min. | 20A | Automotive Available |
| | BNX025H01□ | 3.5 | 25Vdc | 50kHz to 1GHz:35dB min. | 20A | Automotive Available |
| | BNX026H01□ | 3.5 | 50Vdc | 50kHz to 1GHz:35dB min. | 20A | Automotive Available |
| | BNX027H01□ | 3.5 | 16Vdc | 40kHz to 1GHz:35dB min. | 20A | Automotive Available |
| Lead Type Low Profile for Power Lines | p258 BNX012-01 | 8.0 | 50Vdc | 1MHz to 1GHz:40dB min. | 15A | |
| | BNX016-01 | 8.0 | 25Vdc | 100kHz to 1GHz:40dB min. | 15A | |

Suppression of Radiation Noise from Power Line Cable

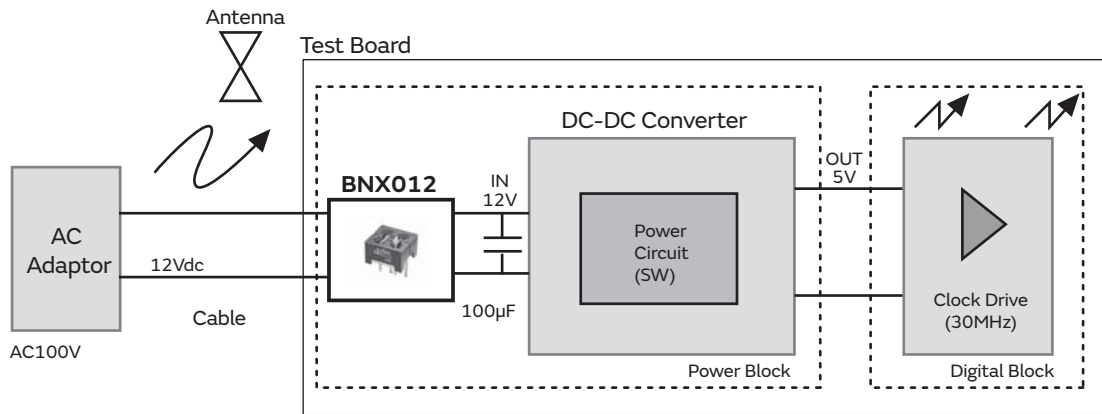

Test Result

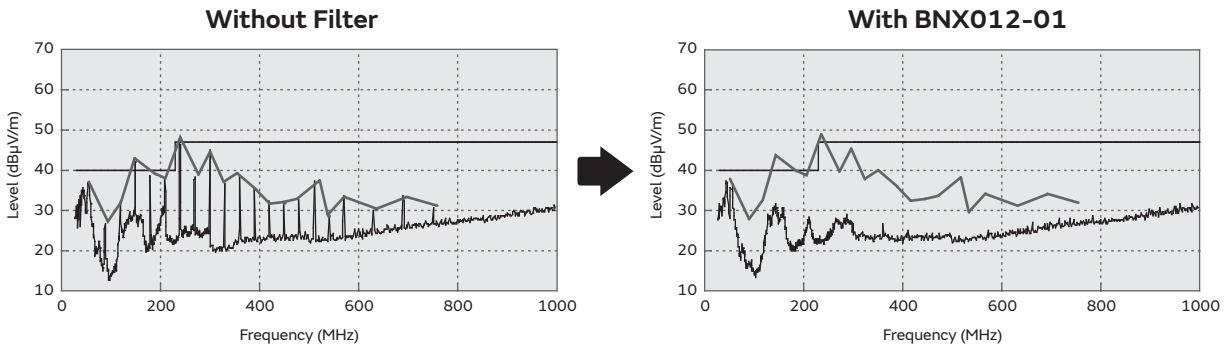

Block Type EMIFIL[®] (BNX) Series Lineup / Function Example

Impulse Noise Countermeasure

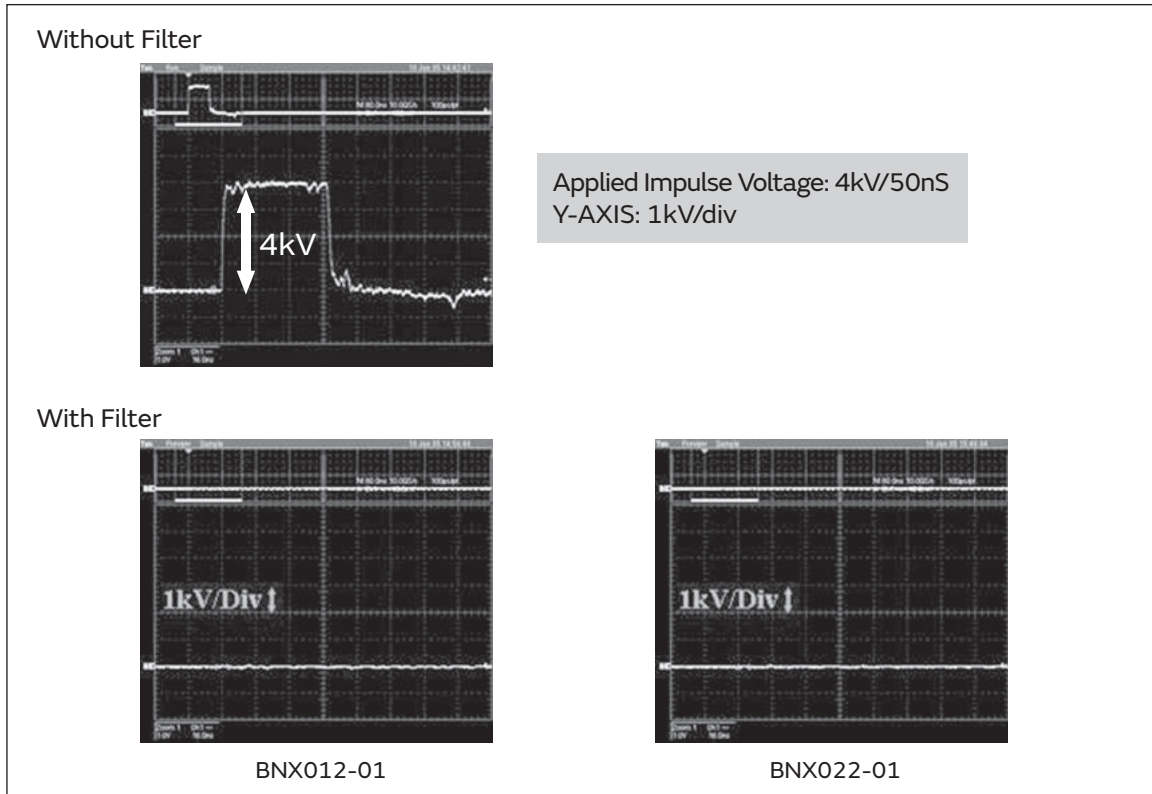
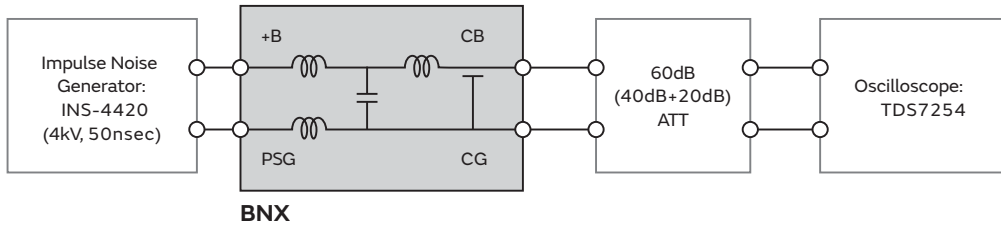

ESD Countermeasure

ESD Waveform Comparison

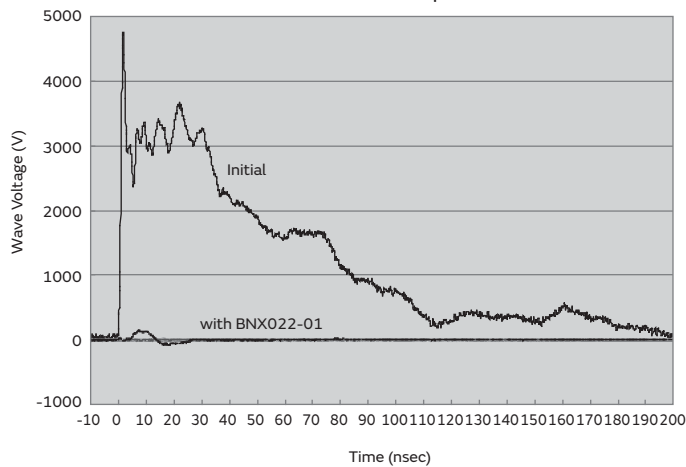

Block Type EMIFIL®

BNX02□ Series

Appearance/Dimensions

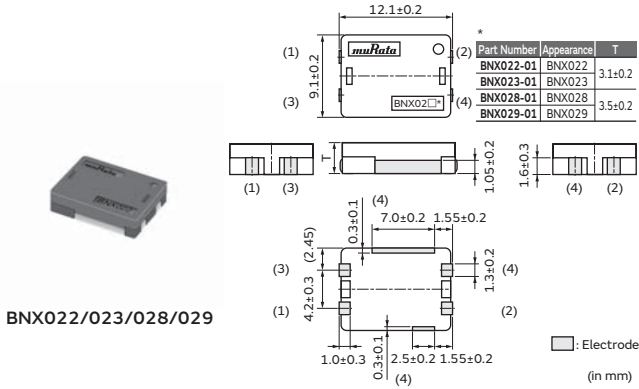

BNX022/023/028/029

Appearance/Dimensions

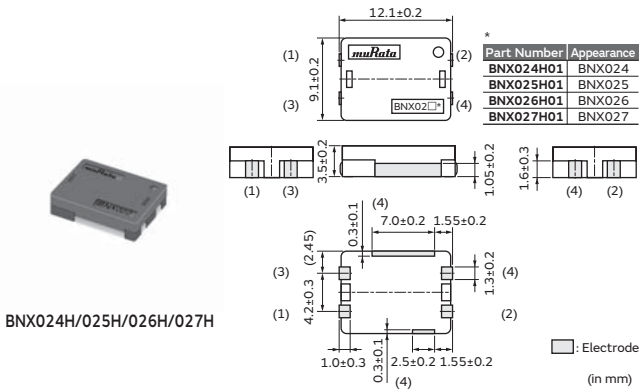

BNX024H/025H/026H/027H

Rated Value (□: packaging code)

| Part Number | Rated Voltage | Withstand Voltage | Rated Current | Insulation Resistance (min.) | Insertion Loss (Line impedance=50 ohm) |
|-------------|---------------|-------------------|---------------|------------------------------|--|
| BNX022-01□ | 50Vdc | 125Vdc | 20A | 500MΩ | 1MHz to 1GHz:35dB min. |
| BNX023-01□ | 100Vdc | 250Vdc | 20A | 500MΩ | 1MHz to 1GHz:35dB min. |
| BNX028-01□ | 16Vdc | 40Vdc | 20A | 1.1MΩ | 30kHz to 1GHz:35dB min. |
| BNX029-01□ | 6.3Vdc | 15.8Vdc | 20A | 0.5MΩ | 15kHz to 1GHz:35dB min. |
| BNX024H01□ | 50Vdc | 125Vdc | 20A | 100MΩ | 100kHz to 1GHz:35dB min. |
| BNX025H01□ | 25Vdc | 62.5Vdc | 20A | 50MΩ | 50kHz to 1GHz:35dB min. |
| BNX026H01□ | 50Vdc | 125Vdc | 20A | 10MΩ | 50kHz to 1GHz:35dB min. |
| BNX027H01□ | 16Vdc | 40Vdc | 20A | 1MΩ | 40kHz to 1GHz:35dB min. |

Operating Temperature Range: -40°C to 125°C (BNX022/023/029), -40°C to 105°C (BNX028), -55°C to 125°C (BNX024H/025H/026H/027H)

Packaging

| Code | Packaging | Minimum Quantity |
|------|----------------------|------------------|
| L | ø180mm Embossed Tape | 400 |
| K | ø330mm Embossed Tape | 1500 |
| B | Bulk(Bag) | 100 |

Equivalent Circuit

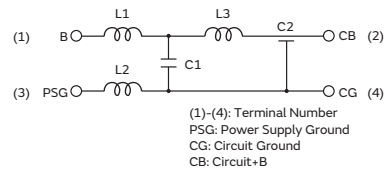

Packaging

| Code | Packaging | Minimum Quantity |
|------|----------------------|------------------|
| L | ø180mm Embossed Tape | 400 |
| K | ø330mm Embossed Tape | 1500 |
| B | Bulk(Bag) | 100 |

Equivalent Circuit

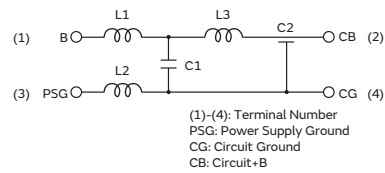

Continued on the following page. ↗

Continued from the preceding page. ↘

Insertion Loss Characteristics

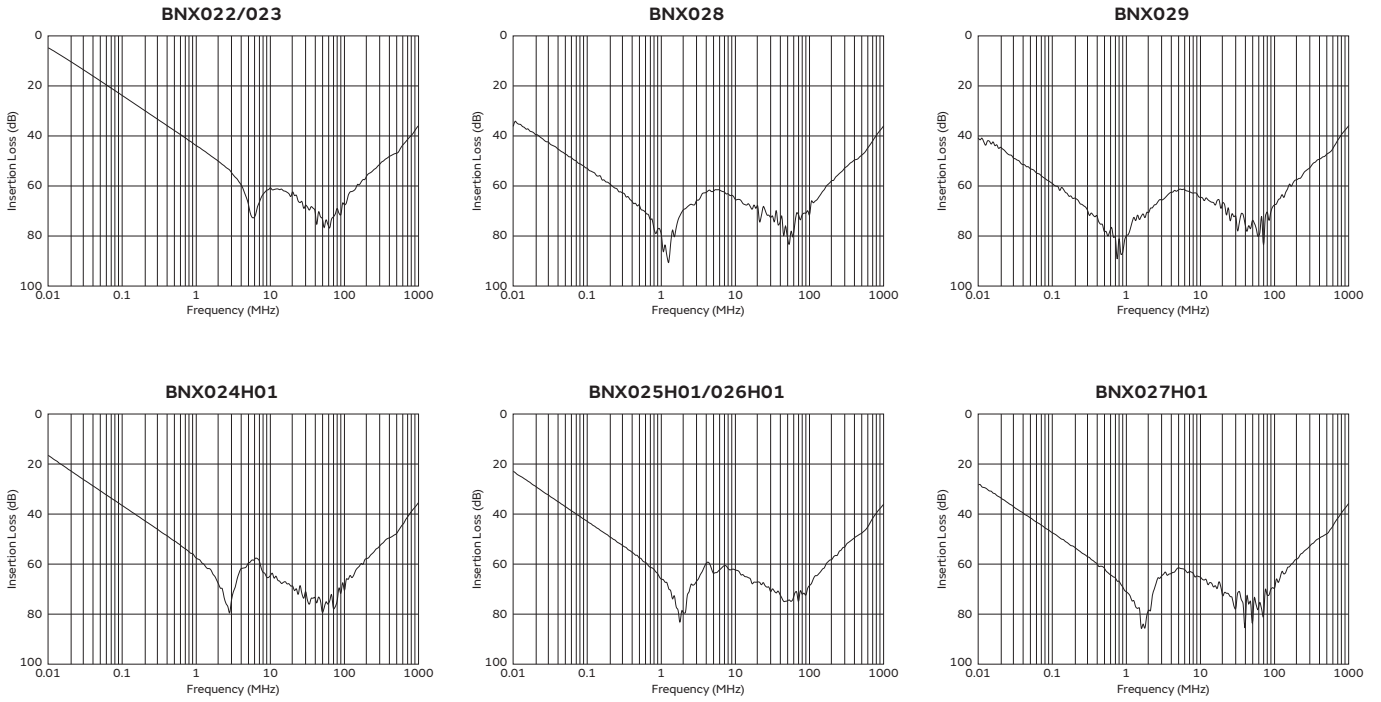

Derating of Rated Current

In operating temperature exceeding +85°C, derating of current is necessary for BNX022/023/029/024H/025H/026H/027H series. Please apply the derating curve shown in chart according to the operating temperature.

In operating temperature exceeding +65°C, derating of current is necessary for BNX028 series. Please apply the derating curve shown in chart according to the operating temperature.

Derating of Rated Current

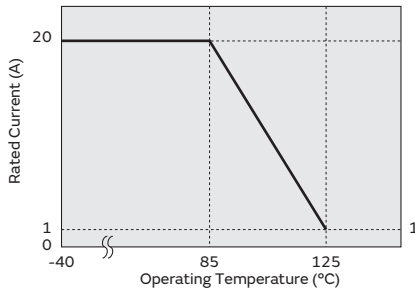

Derating of Rated Current

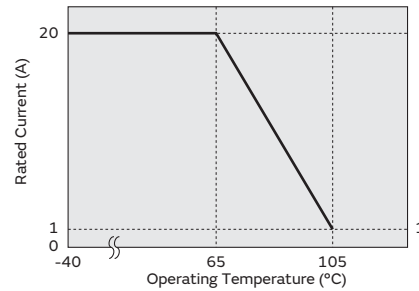

Block Type EMIFIL®

BNX01□ Series

Appearance/Dimensions

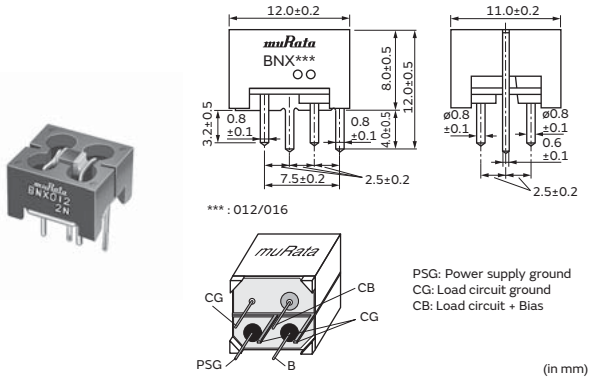

Packaging

| Code | Packaging | Minimum Quantity |
|------|-----------|------------------|
| - | Box | 150 |

Equivalent Circuit

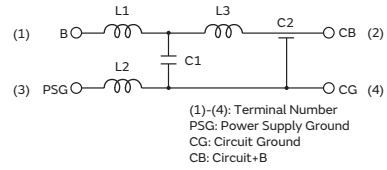

Rated Value

| Part Number | Rated Voltage | Withstand Voltage | Rated Current | Insulation Resistance (min.) | Insertion Loss (Line impedance=50 ohm) |
|-------------|---------------|-------------------|---------------|------------------------------|--|
| BNX012-01 | 50Vdc | 125Vdc | 15A | 500M ohm | 1MHz to 1GHz:40dB min. |
| BNX016-01 | 25Vdc | 62.5Vdc | 15A | 50M ohm | 100kHz to 1GHz:40dB min. |

Operating Temperature Range: -40°C to 125°C

Insertion Loss Characteristics

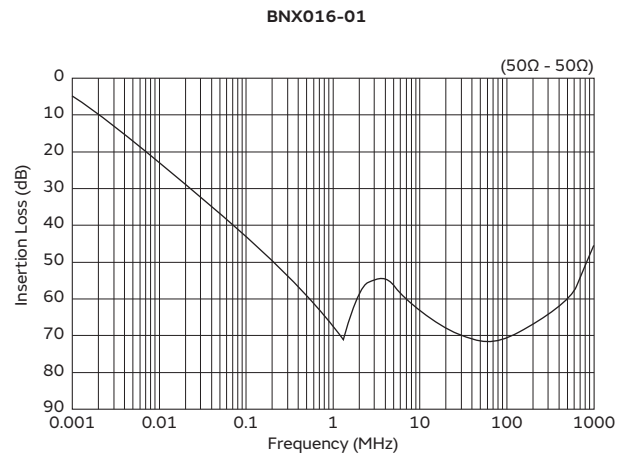
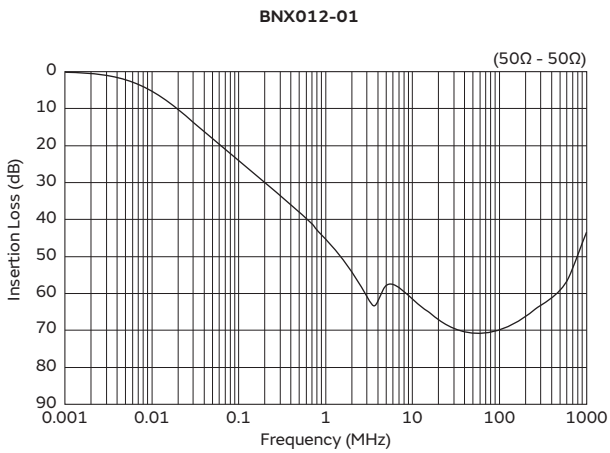

Continued on the following page. ↗

Chip Ferrite Bead

Application Specified Noise Filter

Chip EMIFIL®

Common Mode Choke Coil
 Common Mode Noise Filter

Block Type EMIFIL®

EMC Absorber

Continued from the preceding page. ↘

Derating of Rated Current

In operating temperature exceeding +85°C, derating of current is necessary for BNX01□ series. Please apply the derating curve shown in chart according to the operating temperature.

Derating of Rated Current

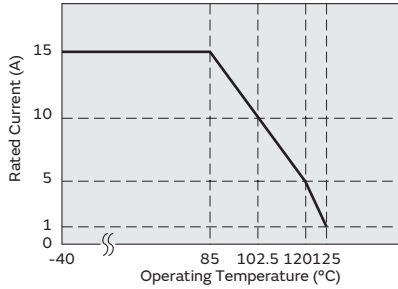

● Connecting ± power line

In case of using ± power line, please connect to each terminal as shown.

| Power Supply (BNX Input) | BNX | Circuit (BNX Output) |
|--------------------------|--------|-----------------------|
| Power Supply +Bias - | B CB | - Load Circuit +Bias |
| Power Supply Ground - | PSG CG | - Load Circuit Ground |
| Power Supply -Bias - | B CB | - Load Circuit -Bias |
| Power Supply Ground - | PSG CG | - Load Circuit Ground |

Block Type EMIFIL[®] SMD Type (BNX) ⚠Caution/Notice

⚠Caution

Rating

Do not use products beyond the rated current and rated voltage as this may create excessive heat and deteriorate the insulation resistance.

Notice

Storage and Operating Conditions

<Operating Environment>

Do not use products in a chemical atmosphere such as chlorine gas, acid or sulfide gas.

Do not use products in an environment close to an organic solvent.

<Storage and Handling Requirements>

1. Storage Period

BNX series should be used within 12 months.

Solderability should be checked if this period is exceeded.

2. Storage Conditions

(1) Storage temperature: -10 to +40°C

Relative humidity: 15 to 85%

Avoid sudden changes in temperature and humidity.

(2) Do not store products in a chemical atmosphere such as chlorine gas, acid or sulfide gas.

Notice (Soldering and Mounting)

1. Cleaning

Do not clean BNX series (SMD Type).

Before cleaning, please contact Murata engineering.

2. Soldering

Reliability decreases with improper soldering methods.

Please solder by the standard soldering conditions shown in the mounting information.

3. Other

Noise suppression levels resulting from Murata's EMI suppression filters EMIFIL[®] may vary, depending on the circuits and ICs used, type of noise, mounting pattern, mounting location, and other operating conditions. Be sure to check and confirm in advance the noise suppression effect of each filter, in actual circuits, etc. before applying the filter in a commercial-purpose equipment design.

Handling

1. Resin Coating

Using resin for coating/molding products may affect the product's performance.

So please pay careful attention in selecting resin.

Prior to use, please make a reliability evaluation with the product mounted in your application set.

2. Handling of Substrates (for BNX02□)

After mounting products on a substrate, do not apply any stress to the product by bending or twisting the substrate

when cropping the substrate, inserting and removing a connector from the substrate or tightening a screw to the substrate.

Excessive mechanical stress may cause cracking in the product.

Bending

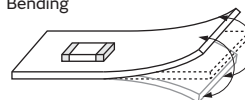

Twisting

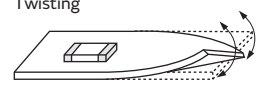

Block Type EMIFIL[®] Lead Type (BNX) ⚠Caution/Notice

⚠Caution

Rating

Do not use products beyond the rated current and rated voltage as this may create excessive heat and deteriorate the insulation resistance.

Notice

Storage and Operating Conditions

<Operating Environment>

1. Do not use products in a chemical atmosphere such as chlorine gas, acid or sulfide gas.
2. Do not use products near water, oil or organic solvents.

<Storage and Handling Requirements>

1. Storage Period

BNX Series should be used within 12 months.
Solderability should be checked if this period is exceeded.

2. Storage Conditions

- (1) Storage temperature: -10 to +40°C
Relative humidity: 15 to 85%
Avoid sudden changes in temperature and humidity.
- (2) Do not store products in a chemical atmosphere such as chlorine gas, acid or sulfide gas.

Notice (Soldering and Mounting)

1. Cleaning

Failure and degradation of a product can be caused by the cleaning method. When you clean in conditions that are not in the mounting information, please contact Murata engineering.

2. Soldering

Reliability decreases with improper soldering methods. Please solder by the standard soldering conditions shown in the mounting information.

3. Other

Noise suppression levels resulting from Murata's EMI suppression filters "EMIFIL" may vary, depending on the circuits and ICs used, type of noise, mounting pattern, lead wire length, mounting location, and other operating conditions. Be sure to check and confirm in advance the noise suppression effect of each filter, in actual circuits, etc. before applying the filter in a commercial-purpose equipment design.

Notice (Appearance)

In some cases, parts of the product surface have a whitish appearance; this is the result of the waxing process for humidity resistance improvement. This wax has no adverse effect on mechanical or electrical performance or on the reliability of the product.

Block Type EMIFIL[®] SMD Type (BNX) Soldering and Mounting

1. Standard Land Pattern Dimensions

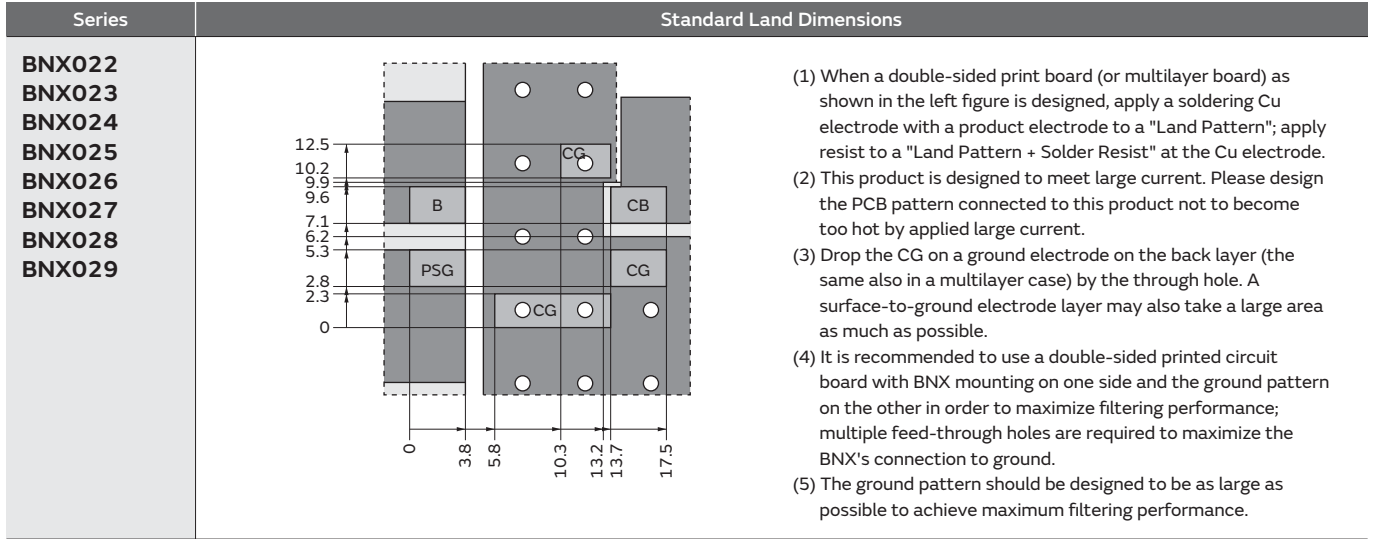

- (1) When a double-sided print board (or multilayer board) as shown in the left figure is designed, apply a soldering Cu electrode with a product electrode to a "Land Pattern"; apply resist to a "Land Pattern + Solder Resist" at the Cu electrode.
- (2) This product is designed to meet large current. Please design the PCB pattern connected to this product not to become too hot by applied large current.
- (3) Drop the CG on a ground electrode on the back layer (the same also in a multilayer case) by the through hole. A surface-to-ground electrode layer may also take a large area as much as possible.
- (4) It is recommended to use a double-sided printed circuit board with BNX mounting on one side and the ground pattern on the other in order to maximize filtering performance; multiple feed-through holes are required to maximize the BNX's connection to ground.
- (5) The ground pattern should be designed to be as large as possible to achieve maximum filtering performance.

● PCB Warping (for BNX02□)

PCB should be designed so that products are not subjected to mechanical stress caused by warping the board.

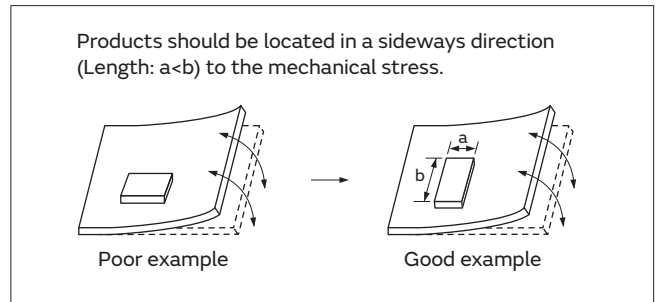

2. Solder Paste Printing and Adhesive Application

When reflow soldering the block type EMIFIL[®], the printing must be conducted in accordance with the following cream solder printing conditions.

If too much solder is applied, the chip will be prone to damage by mechanical and thermal stress from the PCB and may crack.

Standard land dimensions should be used for resist and copper foil patterns.

| Series | Solder Paste Printing | Adhesive Application |
|--|---|----------------------|
| BNX022 BNX023 BNX024 BNX025 BNX026 BNX027 BNX028 BNX029 | <p>●Guideline of solder paste thickness: 150-200μm</p> | |

Continued on the following page. ↗

Block Type EMIFIL[®] SMD Type (BNX) Soldering and Mounting

Continued from the preceding page. ↘

3. Standard Soldering Conditions

(1) Soldering Methods

- Use reflow soldering methods only.
- Use standard soldering conditions when soldering block type EMIFIL[®] SMD type.
- In cases where several different parts are soldered, each having different soldering conditions, use those conditions requiring the least heat and minimum time.

Solder: Use Sn-3.0Ag-0.5Cu solder. Use of Sn-Zn based solder will deteriorate performance of products.

Flux:

- Use rosin-based flux.
 In case of using RA type solder, products should be cleaned completely with no residual flux.
- Do not use strong acidic flux (with chlorine content exceeding 0.20wt%)
- Do not use water-soluble flux.

For additional mounting methods, please contact Murata.

(2) Soldering Profile

- Reflow Soldering Profile
 (Sn-3.0Ag-0.5Cu solder)

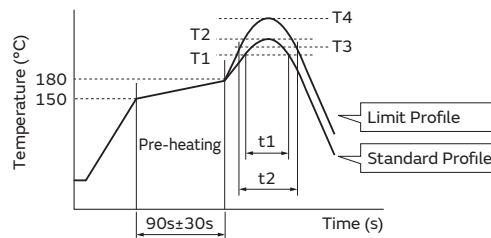

| Series | Standard Profile | | | | Limit Profile | | | |
|--|------------------|-----------|-----------------------|-----------------|---------------|-----------|-----------------------|-----------------|
| | Heating | | Peak Temperature (T2) | Cycle of Reflow | Heating | | Peak Temperature (T4) | Cycle of Reflow |
| | Temp. (T1) | Time (t1) | | | Temp. (T3) | Time (t2) | | |
| BNX022/023/024/025/ 026/027/028/029 | 220°C min. | 30 to 60s | 250±3°C | 2 times max. | 230°C min. | 60s max. | 260°C/10s | 2 times max. |

(3) Reworking with a soldering Iron

- The following conditions must be strictly followed when using a soldering iron.
- Pre-heating: 150°C 60s min.
- Soldering iron power output: 100W max.
- Temperature of soldering iron tip / Soldering time / Times:
- 450°C max. / 5s max. / 2 time

Do not allow the tip of the soldering iron to directly contact the chip.
 For additional methods of reworking with a soldering iron, please contact Murata engineering.

4. Cleaning

Do not clean BNX022/023/024/025/026/027/028/029 series. In case of cleaning, please contact Murata engineering.

Block Type EMIFIL[®] Lead Type (BNX) Soldering and Mounting

1. Mounting Hole

■ Mounting holes should be designed as specified below.

| Series | Mounting Hole |
|--------|--|
| BNX01□ | <p>Component Side</p> <p>Terminal Layout (Bottom figure)</p> <p>PSG: Power supply ground CG: Load circuit ground CB: Load circuit + Bias</p> |

2. Using the Block Type EMIFIL[®] (Lead Type) Effectively

(1) How to use effectively

This product effectively prevents undesired radiation and external noise from going out / entering the circuit by grounding the high frequency components that cause noise problems. Therefore, grounding conditions may affect the performance of the filter and attention should be paid to the following for effective use.

- Design maximized grounding area in the PCB, and grounding pattern for all the grounding terminals of the product to be connected. (Please follow the specified recommendations.)
- Minimize the distance between ground of the PCB and the ground plate of the product. (Recommend using the through hole connection between the grounding area both on the component side and the bottom side.)
- Insert the terminals into the holes on the PCB completely.
- Don't connect PSG terminal with CG terminal directly. (See the item 1. Terminal Layout)

(2) Self-heating

Though this product has a large rated current, localized self-heating may be caused depending on soldering conditions. To avoid this, attention should be paid to the following:

- Use a PCB with our recommendation on hole diameter / land pattern dimensions, mentioned in the right-hand drawing, especially for 4 terminals that pass current.
- Solder the terminals to the PCB with solder cover area at least 90%. Otherwise, excess self-heating at the connection between terminals and the PCB may lead to smoke and / or fire of the product even when operating at rated current.
- After installing this product in your product, please ensure that the self-heating is within the rated current recommended.

PCB Patterns

Use a bilateral PCB. Insert the BNX into the PCB until the root of the terminal is secured, then solder.

(1) Component Side View

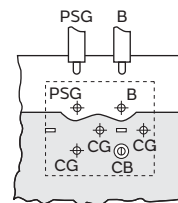

(2) Bottom View

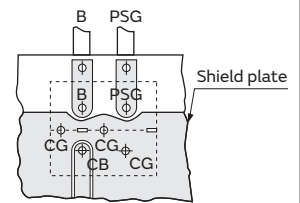

■ Copper foil pattern

Recommended Land Pattern

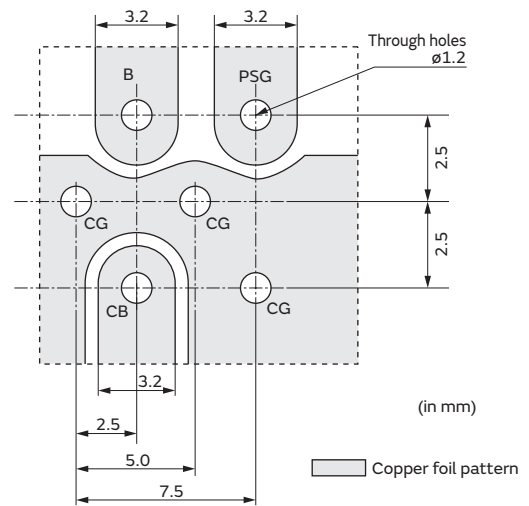

Continued on the following page. ↗

Block Type EMIFIL[®] Lead Type (BNX) Soldering and Mounting

Continued from the preceding page. ↘

3. Soldering

- (1) Use Sn-3.0Ag-0.5Cu solder.
- (2) Use rosin-based flux. Do not use strong acidic flux with halide content exceeding 0.2wt% (chlorine conversion value).
- (3) Products and the leads should not be subjected to any mechanical stress during the soldering process, or while subjected to the equivalent high temperatures.
- (4) Standard flow soldering profile

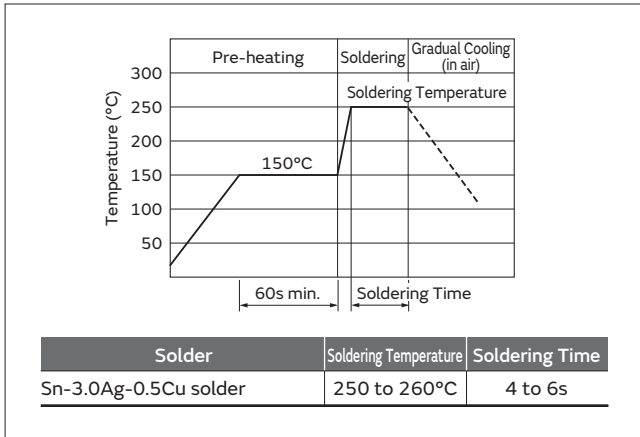

4. Cleaning

Clean the block Type EMIFIL[®](Lead Type) in the following conditions.

- (1) Cleaning temperature should be limited to 60°C max. (40°C max for alcohol type cleaner).
- (2) Ultrasonic cleaning should comply with the following conditions, avoiding the resonance phenomenon at the mounted products and PCB.
 Power: 20W/liter max.
 Frequency: 28 to 40kHz
 Time: 5 min. max.
- (3) Cleaner
 - (a) Alcohol type cleaner
 Isopropyl alcohol (IPA)
 - (b) Aqueous agent
 Pine Alpha ST-100S
- (4) There should be no residual flux or residual cleaner left after cleaning.
 In the case of using aqueous agent, products should be dried completely after rinsing with de-ionized water in order to remove the cleaner.
- (5) The surface of products may become dirty after cleaning, but there is no deterioration of mechanical or electrical characteristics or reliability.
- (6) Other cleaning: Please contact us.

Block Type EMIFIL® SMD Type (BNX) Packaging

Minimum Quantity and Dimensions of 24mm Width Embossed Tape

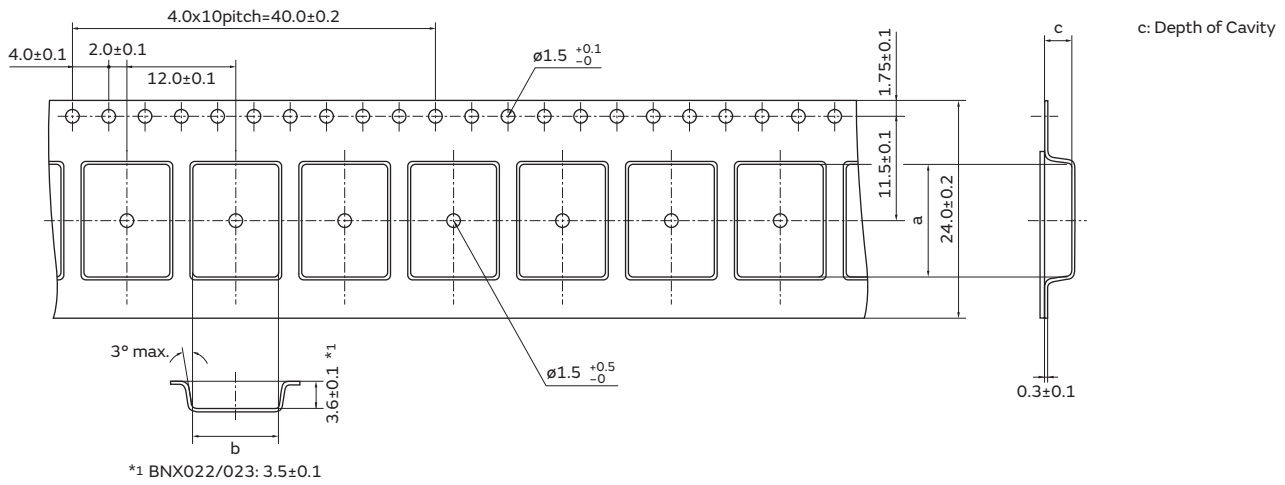

Dimension of the cavity is measured at the bottom side.

| Part Number | Dimensions | | | Minimum Qty. (pcs.) | | |
|----------------------------|------------|-----|-----|---------------------|-------------|------|
| | a | b | c | ø180mm Reel | ø330mm Reel | Bulk |
| BNX022/023 | 12.4 | 9.4 | 3.5 | 400 | 1500 | 100 |
| BNX024/025/026/027/028/029 | 12.4 | 9.4 | 3.6 | | | |

(in mm)

"Minimum Quantity" means the number of units of each delivery or order. The quantity should be an integral multiple of the "Minimum Quantity."

EMC Absorber EA20/EA21 Series

| | |
|----------------------|------|
| Part Numbering | p268 |
| Product Detail | p269 |
| Notice | p270 |

● Part Numbering

EMC Absorber

(Part Number)

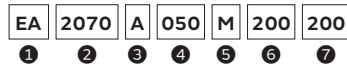

① Product ID

| Product ID | |
|------------|--------------|
| EA | EMC Absorber |

② Sheet Type

| Code | Sheet Type |
|------|--|
| 2070 | Metal Flake Powder (Halogen Free type) |
| 2100 | Metal Flake Powder (UL certified type) |

③ Adhesive Tape Type

| Code | Adhesive Tape Type |
|------|---|
| A | Standard tape type (Halogen Free type) |
| B | Thin adhesive tape type (Halogen Free type) |

④ Outer Dimension Supplement Code

Expressed by 3 digits including the second decimal place in mm.

Ex.)

| Code | Sheet Thickness |
|------|-----------------|
| 020 | 0.20mm |

⑤ Unit of Dimension

One capital letter expresses Unit of Dimension (⑥) and Dimensions Length (⑦).

| Code | Unit of Dimension |
|------|-------------------|
| M | in mm (Standard) |
| C | in cm (Standard) |

Standard shape is a rectangle.

Please contact us for other shapes.

⑥ Dimension (Length)

Expressed by 3 digits including the first decimal place.

⑦ Dimension (Width)

Expressed by 3 digits including the first decimal place.

Ex.)

| Code | Dimension (Length × Width) |
|---------|----------------------------|
| M300150 | 30.0×15.0 mm |
| C150100 | 15.0×10.0 cm |

"Halogen Free" is defined to satisfy the following conditions for EMC Absorber listed in this catalog.

1. Chlorine will not exceed 900ppm.
2. Bromine will not exceed 900ppm.
3. The total amount of chlorine and bromine will not exceed 1500ppm.

EMC Absorber

EA20/EA21 Series

Appearance/Dimensions



Packaging

When inquiring, please contact us with size code, referring to "Part Numbering."

Rated Value

| Part Number | Applicable Frequency (Typ.) | Thickness (Typ.) | Flame Class | Halogen | Operating Temperature Range |
|-------------|-----------------------------|------------------|-------------|--------------|-----------------------------|
| EA2070A050 | 0.1 to 3.0GHz | 0.50mm | - | Halogen Free | -40°C to 120°C |
| EA2070A100 | 0.1 to 3.0GHz | 1.00mm | - | Halogen Free | -40°C to 120°C |
| EA2070B010 | 0.1 to 3.0GHz | 0.10mm | - | Halogen Free | -40°C to 120°C |
| EA2070B013 | 0.1 to 3.0GHz | 0.13mm | - | Halogen Free | -40°C to 120°C |
| EA2070B020 | 0.1 to 3.0GHz | 0.20mm | - | Halogen Free | -40°C to 120°C |
| EA2100A050 | 0.1 to 3.0GHz | 0.50mm | UL94V-0 | - | -40°C to 120°C |
| EA2100A100 | 0.1 to 3.0GHz | 1.00mm | UL94V-0 | - | -40°C to 120°C |
| EA2100B020 | 0.1 to 3.0GHz | 0.20mm | UL94V-0 | - | -40°C to 120°C |

Magnetic Permeability-Reluctance

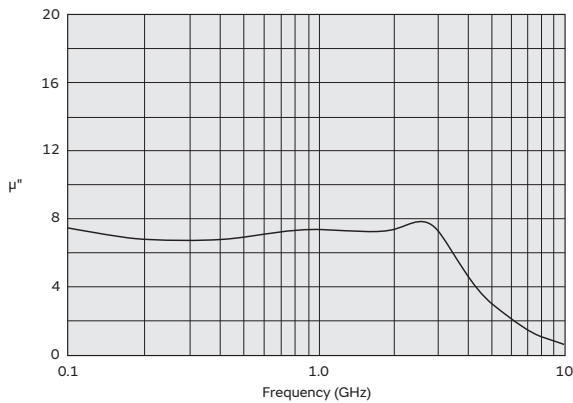

EMC Absorber (EA20/EA21) Notice

Notice

Storage and Operating Conditions

1. Adhesive Tape Stress

This product is designed to use adhesive tape to hold itself to the object.

And please avoid causing mechanical stress by bending or variation of the object.

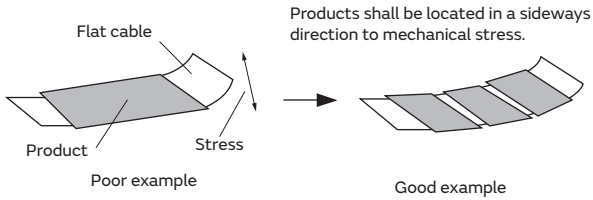

2. Cleaning

Avoid cleaning this product.

3. Handling of the Product

Adhesive tape must be clean to maintain the quality of adhesion.

Please wipe off any dirt, dust and any kind of oil from the surface of the object before use.

4. Storage Conditions

(1) Storage period

Products that were inspected by Murata over 6 months ago should be examined and used. This can be confirmed by the inspection number marked on the container.

Adhesiveness should be checked if this period is exceeded.

(2) Storage conditions

• Products should be stored in the warehouse in the following conditions:

Temperature: -10 to +40°C

Humidity: 30 to 70% relative humidity

No rapid change of temperature or humidity

• Products should be stored in the warehouse without heat shock condition, vibration, direct sunlight and so on.

Part Number Quick Reference

| | | | | | |
|---------|-----|-------------|-----|------------|-----|
| BLA2AAG | 89 | BLM18BB | 65 | DLW5AT_MQ2 | 233 |
| BLA2ABB | 90 | BLM18BD | 65 | DLW5AT_SQ2 | 231 |
| BLA2ABD | 90 | BLM18EG | 107 | DLW5AT_TQ2 | 234 |
| BLA31AG | 92 | BLM18GG | 109 | DLW5BS_SQ2 | 229 |
| BLA31BD | 93 | BLM18HB | 103 | DLW5BS_TQ2 | 235 |
| BLE18PS | 145 | BLM18HD | 103 | DLW5BT_SQ2 | 236 |
| BLE32PN | 146 | BLM18HE | 103 | DLW5BT_TQ2 | 237 |
| BLF02JD | 142 | BLM18HG | 103 | EA20 | 269 |
| BLF02RD | 143 | BLM18HK | 103 | EA21 | 269 |
| BLF03JD | 144 | BLM18KG | 57 | LQW04CA_00 | 147 |
| BLM02AX | 29 | BLM18PG | 55 | LQW15CA_00 | 148 |
| BLM02BB | 31 | BLM18RK | 69 | LQW18CA_00 | 150 |
| BLM02BC | 31 | BLM18SD | 59 | NFA18SD | 181 |
| BLM02BX | 32 | BLM18SG | 59 | NFA18SL | 178 |
| BLM02KX | 28 | BLM18SN | 59 | NFA21SL | 182 |
| BLM02PX | 26 | BLM18TG | 64 | NFE31PT | 172 |
| BLM03AG | 36 | BLM21AG | 75 | NFE61PT | 173 |
| BLM03AX | 38 | BLM21BB | 77 | NFL18SP | 176 |
| BLM03BB | 39 | BLM21BD | 77 | NFL18ST | 174 |
| BLM03BC | 39 | BLM21PG | 71 | NFL21SP | 177 |
| BLM03BD | 39 | BLM21RK | 80 | NFP0Q | 226 |
| BLM03BX | 41 | BLM21SN | 73 | NFW31SP | 184 |
| BLM03EB | 96 | BLM21SP | 73 | NFZ03SG | 126 |
| BLM03HB | 94 | BLM31KN | 81 | NFZ15SG | 127 |
| BLM03HD | 94 | BLM31PG | 83 | NFZ18SM | 129 |
| BLM03HG | 94 | BLM31SN | 85 | NFZ2HBM | 133 |
| BLM03PG | 33 | BLM41PG | 86 | NFZ2MSM | 131 |
| BLM03PX | 34 | BLT5BPT_LN1 | 88 | NFZ32BW | 135 |
| BLM15AG | 47 | BNX01□ | 258 | NFZ32SW | 132 |
| BLM15AX | 48 | BNX02□ | 256 | NFZ5BBW | 139 |
| BLM15BA | 50 | DLMONS | 203 | PLT10HH | 239 |
| BLM15BB | 50 | DLMOQS | 202 | PLT5BPH | 238 |
| BLM15BC | 50 | DLM11G | 205 | | |
| BLM15BD | 50 | DLM11S | 206 | | |
| BLM15BX | 53 | DLPONS | 208 | | |
| BLM15EG | 99 | DLP0QS | 207 | | |
| BLM15EX | 100 | DLP11R | 210 | | |
| BLM15GA | 102 | DLP11S | 212 | | |
| BLM15GG | 102 | DLP11T | 214 | | |
| BLM15HB | 97 | DLP1ND | 216 | | |
| BLM15HD | 97 | DLP2AD | 217 | | |
| BLM15HG | 97 | DLP31D | 219 | | |
| BLM15KD | 46 | DLP31S | 215 | | |
| BLM15PD | 42 | DLW21H | 220 | | |
| BLM15PG | 42 | DLW21S | 222 | | |
| BLM15PX | 44 | DLW31S | 225 | | |
| BLM18AG | 62 | DLW44S | 228 | | |
| BLM18BA | 65 | DLW5AH_SQ2 | 229 | | |

Introduction of Related Catalog: Lead Type EMIFIL®

Please refer to catalog below for Lead Type EMIFIL®.

Lead Type EMIFIL®

EMI Suppression Filters (Lead Type EMIFIL®)

Contents Ferrite Beads Inductors
 Disc Type EMIFIL®
 EMIGUARD® (EMIFIL® with Varistor Function)
 Common Mode Choke Coils



Noise Suppression Basic Course

Use this course to improve your knowledge of various EMI suppression topics, including: noise emission mechanisms, conduction route, characteristics of electromagnetic noise.

https://www.murata.com/en-global/products/emc/emifil/knowhow/basic?intcid5=com_XXX_XXX_cmh_hd_XXX

Noise Suppression Basic Course

› Noise Suppression Basic Course Section 1

For engineers who are involved in noise suppression basic contents are compiled to understand noise suppression with suppression filter (EMIFIL®).

› Noise Suppression Basic Course Section 2

In Section 2, we will explain practical approaches and methods of noise suppression, deciding on themes as we proceed.

Noise Suppression Basic Course [Section 1]

For engineers who are involved in noise suppression, basic contents are compiled to understand noise suppression with EMI suppression filter (EMIFIL®).



Chapter 1

Reasons for requiring EMI suppression filters

Chapter 1 describes the reasons for using EMI suppression filter and explains how shields and filters used for electromagnetic noise suppression.

[Average time required for reading: approx.12 mins]



Chapter 2

Mechanism of Causing Electromagnetic Noise

In order to have a deep understanding of the mechanism of causing electromagnetic noise, Chapter 2 focuses on the issues regarding the noise source and the mechanism of noise occurrence such as how the noise occurs in the electric circuit.

[Average time required for reading: approx.47 mins]

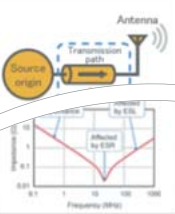

Chapter 3

Factors of making noise problems complex

In order to handle the noise interference for electronic devices, it is necessary to understand not only the noise source origin, but also the characteristics of the noise source, the noise path and antennas. Among these topics, Chapter 3 describes the factors of making noise problems complex.

[Average time required for reading: approx.50 mins]

[Average time required for reading: approx.55 mins]

Chapter 1

Reasons for requiring EMI suppression filters (EMIFIL®)

1-1. Introduction

An EMI suppression filter (EMIFIL®) is an electronic component for providing electromagnetic noise suppression for electronic devices and is used in conjunction with shields and other protection. This filter only extracts and removes components that can cause electromagnetic noise from electric currents that are conducted through wiring. Chapter 1 describes the reasons for using EMI suppression filters (EMIFIL®) in electronic devices and also provides an overview of the operations of shields and filters that are typical parts used for electromagnetic noise suppression.

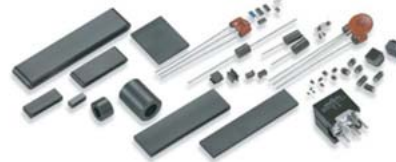

Fig. 1-1 EMI suppression filters (EMIFIL®)

• Top of page

Noise Suppression Basic Course [Section 2]

In Section 2, we will explain practical approaches and methods of noise suppression, deciding on themes as we proceed.



Theme 1

Proper Use of Noise Suppression Products for Digital Circuits

To resolve the problem of noise inflicted onto radios, TVs, and other devices, EMI suppression filters have become widely used. This theme explains examples of the proper use of typical EMI suppression filters: capacitors, ferrite beads. Also, this theme explains the reason why the noise suppression effect varies among sets.

[Average time required for reading: approx.21 mins]

Theme 1

Noise suppression in digital signal lines

1-1. Introduction

During my university days, there was always noise coming from my FM radio whenever I listened to it beside my PC. The radiation noise from the PC entered and hindered the FM radio. At that time, I didn't know the cause and never even dreamed that I would face this problem after joining the company. When I started actual work on noise suppression, it was so difficult that it took several months in some cases. The major reasons are as follows:

- (1) It is unknown where the noise is generated from (noise source) and how it is conducted
- (2) Appropriate noise suppression methods are difficult to grasp

When the correct noise suppression method was unknown, various things crossed my mind: for example, maybe the part dealt with at that time was wrong and I should deal with another part. It is not rare that a noise suppression method effective for a set, such as filtering, is not effective for another set, which left me scratching my head.

Therefore, I felt the necessity for organized theoretical noise suppression methods, and correct filter selection methods. As part of my research, I investigated the causes and other factors of the difference in the noise suppression effect on the same noise filter depending on the circuit, and summarized them as specific examples. This document describes the contents.



Global Locations

For details please visit www.murata.com



⚠ Note

1 Export Control

For customers outside Japan:

No Murata products should be used or sold, through any channels, for use in the design, development, production, utilization, maintenance or operation of, or otherwise contribution to (1) any weapons (Weapons of Mass Destruction [nuclear, chemical or biological weapons or missiles] or conventional weapons) or (2) goods or systems specially designed or intended for military end-use or utilization by military end-users.

For customers in Japan:

For products which are controlled items subject to the "Foreign Exchange and Foreign Trade Law" of Japan, the export license specified by the law is required for export.

2 Please contact our sales representatives or product engineers before using the products in this catalog for the applications listed below, which require especially high reliability for the prevention of defects which might directly damage a third party's life, body or property, or when one of our products is intended for use in applications other than those specified in this catalog.

- ① Aircraft equipment
- ② Aerospace equipment
- ③ Undersea equipment
- ④ Power plant equipment
- ⑤ Medical equipment
- ⑥ Transportation equipment (vehicles, trains, ships, etc.)
- ⑦ Traffic signal equipment
- ⑧ Disaster prevention / crime prevention equipment
- ⑨ Data-processing equipment
- ⑩ Application of similar complexity and/or reliability requirements to the applications listed above

3 Product specifications in this catalog are as of September 2018. They are subject to change or our products in it may be discontinued without advance notice. Please check with our sales representatives or product engineers before ordering. If there are any questions, please contact our sales representatives or product engineers.

4 Please read rating and ⚠CAUTION (for storage, operating, rating, soldering, mounting and handling) in this catalog to prevent smoking and/or burning, etc.

5 This catalog has only typical specifications. Therefore, please approve our product specifications or transact the approval sheet for product specifications before ordering.

6 Please note that unless otherwise specified, we shall assume no responsibility whatsoever for any conflict or dispute that may occur in connection with the effect of our and/or a third party's intellectual property rights and other related rights in consideration of your use of our products and/or information described or contained in our catalogs. In this connection, no representation shall be made to the effect that any third parties are authorized to use the rights mentioned above under licenses without our consent.

7 No ozone depleting substances (ODS) under the Montreal Protocol are used in our manufacturing process.

Murata Manufacturing Co., Ltd.

www.murata.com

muRata
INNOVATOR IN ELECTRONICS

Mouser Electronics

Authorized Distributor

Click to View Pricing, Inventory, Delivery & Lifecycle Information:

Murata:

[BLM15AG100SN1D](#) [BLM15BB050SN1D](#) [BLM15BB100SN1D](#) [BLM15BB121PN1D](#) [BLM15BB121SN1D](#)
[BLM15BB220SN1D](#) [BLM15BB221SN1D](#) [BLM15BB750SN1D](#) [BLM15BD421PN1D](#) [BLM15BD471SN1D](#)
[BLM15BD601SN1D](#) [BLM18AG151SN1D](#) [BLM18BA470SN1D](#) [BLM18BB151SN1D](#) [BLM18BB471SN1D](#)
[BLM18BD151SN1D](#) [BLM18BD222SN1D](#) [BLM18BD331SN1D](#) [BLM18EG391TN1D](#) [BLM18HK471SN1D](#)
[BLM18RK121SN1D](#) [BLM18RK221SN1D](#) [BLM31AF700SH1L](#) [BLM31BE601SH1L](#) [BLM41PG101SN1L](#)
[DLW5AHN402SQ2L](#) [NFE31PT222Z1E9L](#) [NFE31PT471F1E9L](#) [NFE61HT332Z2A9L](#) [BLM18HD102SN1D](#)
[NFE61HT181C2A9L](#) [NFE61PT361B1H9L](#) [DLW5BSN152SQ2L](#) [DLW5BSN191SQ2L](#) [DLW5BSN102SQ2L](#)
[DLW5BSN302SQ2L](#) [BLM15BD601PN1D](#) [DLW21SN261SQ2L](#) [NFE31PT470C1E9L](#) [DLW5BSN351SQ2L](#)
[BLM31PG391SN1L](#) [BLM18HG471SN1D](#) [DLP31SN221SL2B](#) [DLP31SN221SL2L](#) [DLP31SN121SL2L](#)
[BLM03AG121SN1D](#) [DLP31DN441ML4L](#) [NFE61HT330U2A9L](#) [BLM15AG102AN1D](#) [BLM15AG601AN1D](#)
[BLM15EG121SN1D](#) [BLM15EG221SN1D](#) [BLM15HD102SN1D](#) [BLM15HD182SN1D](#) [BLM15HG102SN1D](#)
[BLM15HG601SN1D](#) [BLM15PG100SN1D](#) [BLM18EG121SN1D](#) [BLM18EG221SN1D](#) [BLM18GG471SN1D](#)
[BLM18PG221SN1D](#) [BLM18PG331SN1D](#) [NFE61HT102F2A9B](#) [DLP31DN471SL4L](#) [BLM18AG471SN1D](#)
[BLM41PG102SN1L](#) [BLM18BB220SN1D](#) [NFW31SP106X1E4L](#) [DLW21HN670SQ2L](#) [BLM31BE601FN1L](#)
[DLW21SN670SQ2L](#) [NFE61PT680B1H9L](#) [BLM18BB470SN1D](#) [BLM15AG601PN1D](#) [NFR21GD4706802L](#)
[BLM18BD421SN1D](#) [NFE31PT220R1E9L](#) [BLM41PF800SN1L](#) [DLW21SN181SQ2L](#) [BLM41AF151SN1L](#)
[NFR21GD1002202L](#) [DLP11SN161SL2L](#) [NFR21GD4702202L](#) [DLW21HN181SQ2L](#) [NFL21SP206X1C3D](#)
[NFE61PT681B1H9L](#) [NFE61PT181B1H9L](#) [BLM15BD102PN1D](#) [NFE61PT101Z1H9L](#) [BLM41PG181SN1L](#)
[BLM41AF800SN1B](#) [NFR21GD1016802L](#) [NFE61HT332Z2A9B](#) [NFR21GD1004702L](#) [BLM31AJ601SN1L](#)
[BLM18AG601SN1D](#) [BLM18PG300SN1D](#) [DLP11SN201SL2L](#) [DLW31SN601SQ2L](#) [DLP31DN900SL4L](#)