

200mW High Speed SMD Switching Diode

FEATURES

- Low power loss, high efficiency
- Ideal for automated placement
- High surge current capability
- Moisture sensitivity level: level 1, per J-STD-020
- Compliant to RoHS directive 2011/65/EU and in accordance to WEEE 2002/96/EC
- Halogen-free according to IEC 61249-2-21

APPLICATIONS

- Switching mode power supply (SMPS)
- Adapters
- Lighting application
- On-board DC/DC converter

MECHANICAL DATA

- Case: SOD-323F
- Molding compound meets UL 94 V-0 flammability rating
- Terminal: Matte tin plated leads, solderable per J-STD-002
- Meet JESD 201 class 1A whisker test
- Polarity: Indicated by cathode band
- Weight: 4.85 ± 0.5 mg

KEY PARAMETERS		
PARAMETER	VALUE	UNIT
V_{RRM}	100	V
V_F at $I_F=100mA$	1.0	V
T_J MAX.	150	°C
Package	SOD-323F	
Configuration	Single die	

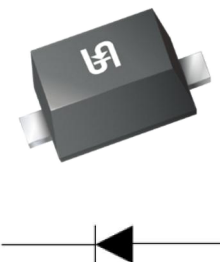

ABSOLUTE MAXIMUM RATINGS ($T_A = 25^\circ\text{C}$ unless otherwise noted)					
PARAMETER	SYMBOL	1N4148 WS	1N4448 WS	1N914B WS	UNIT
Marking code on the device		S1	S2	S3	
Power dissipation	P_D	200			mW
Repetitive peak reverse voltage	V_{RRM}	100			V
Forward current	I_F	150			mA
Non-repetitive peak forward current	I_{FRM}	300			mA
Junction temperature range	T_J	-65 to +150			°C
Storage temperature range	T_{STG}	-65 to +150			°C

THERMAL PERFORMANCE			
PARAMETER	SYMBOL	TYP	UNIT
Junction-to-ambient thermal resistance	$R_{\theta JA}$	625	°C/W

ELECTRICAL SPECIFICATIONS ($T_A = 25^\circ\text{C}$ unless otherwise noted)					
PARAMETER	CONDITIONS	SYMBOL	MIN	MAX	UNIT
Forward voltage ⁽¹⁾	1N4448WS, 1N914BWS $I_F = 5 \text{ mA}, T_J = 25^\circ\text{C}$	V_F	0.62	0.72	V
	1N4148WS $I_F = 10 \text{ mA}, T_J = 25^\circ\text{C}$		-	1.00	
	1N4448WS, 1N914BWS $I_F = 100 \text{ mA}, T_J = 25^\circ\text{C}$		-	1.00	
Reverse voltage	$I_R = 5 \mu\text{A}, T_J = 25^\circ\text{C}$	V_R	75	-	V
	$I_R = 100 \mu\text{A}, T_J = 25^\circ\text{C}$		-	100	
Reverse current @ rated V_R ⁽²⁾	$V_R = 20\text{V}, T_J = 25^\circ\text{C}$	I_R	-	25	nA
	$V_R = 75\text{V}, T_J = 25^\circ\text{C}$		-	5	μA
Junction capacitance	1 MHz, $V_R = 0\text{V}$	C_J	-	4	pF
Reverse recovery time	$I_F = 10\text{mA}, I_R = 60\text{mA}, R_L = 100\Omega,$ $I_{RR} = 1\text{mA}$	t_{rr}	-	4	ns

Notes:

1. Pulse test with $PW = 0.3 \text{ ms}$
2. Pulse test with $PW = 30 \text{ ms}$

ORDERING INFORMATION		
PART NO.	PACKAGE	PACKING
1N4148WS RRG	SOD-323F	3K / 7" Reel
1N4148WS RR	SOD-323F	3K / 7" Reel
1N4148WS R9G	SOD-323F	10K / 13" Reel
1N4148WS R9	SOD-323F	10K / 13" Reel
1N4448WS RRG	SOD-323F	3K / 7" Reel
1N4448WS RR	SOD-323F	3K / 7" Reel
1N4448WS R9G	SOD-323F	10K / 13" Reel
1N4448WS R9	SOD-323F	10K / 13" Reel
1N914BWS RRG	SOD-323F	3K / 7" Reel
1N914BWS RR	SOD-323F	3K / 7" Reel
1N914BWS R9G	SOD-323F	10K / 13" Reel
1N914BWS R9	SOD-323F	10K / 13" Reel

CHARACTERISTICS CURVES

($T_A = 25^\circ\text{C}$ unless otherwise noted)

Fig. 1 Forward Voltage VS. Forward Current

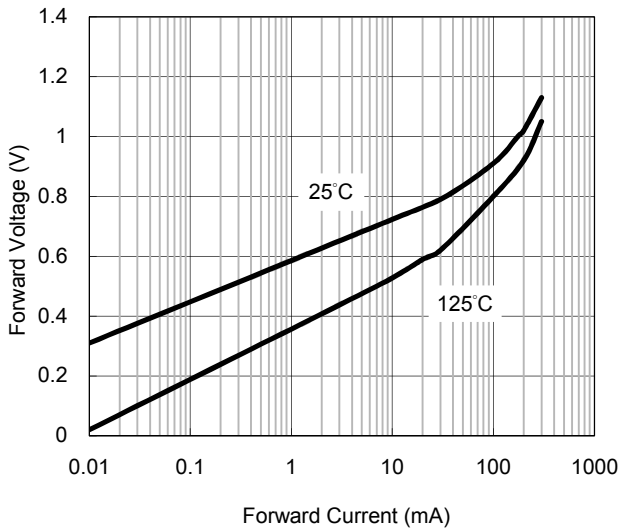

Fig. 2 Reverse Current vs Reverse Voltage

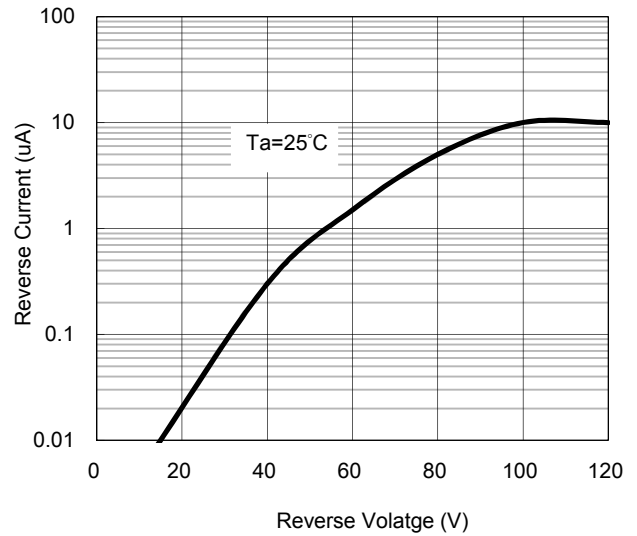

Fig. 3 Admissible Power Dissipation Curve

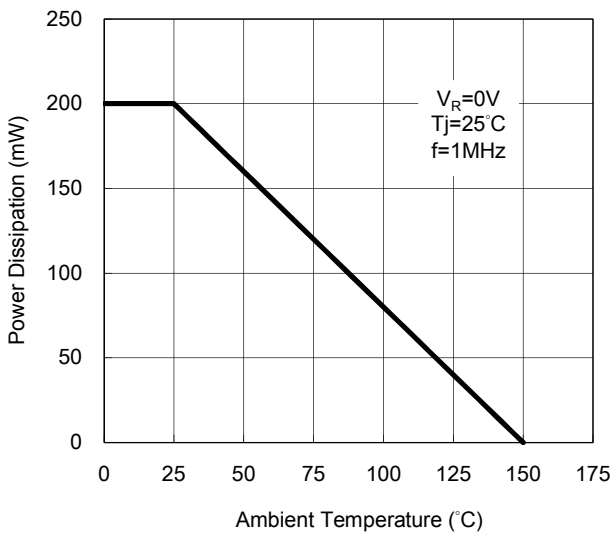
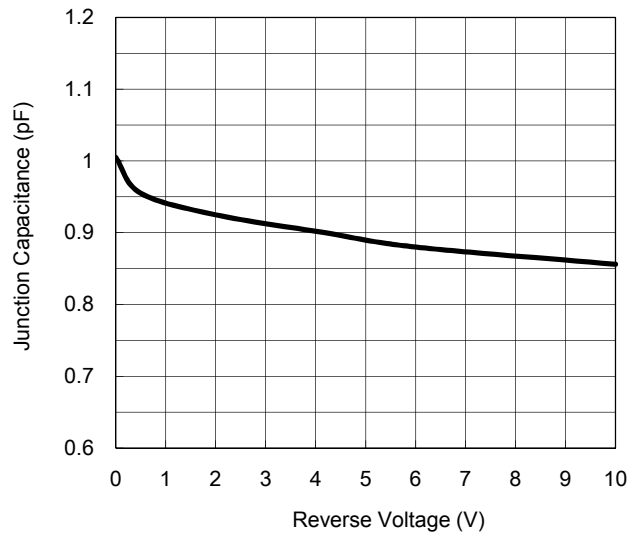
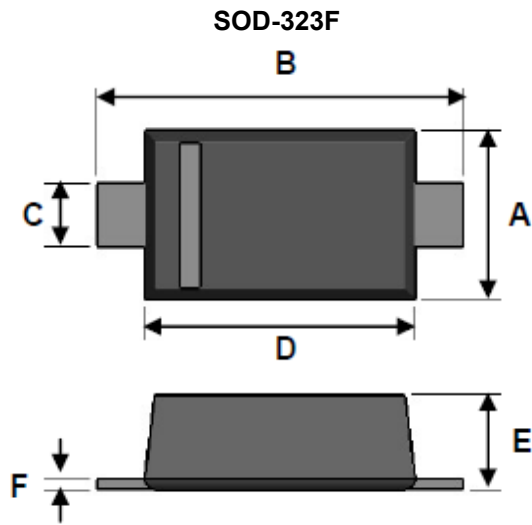

Fig. 4 Typical Junction Capacitance



PACKAGE OUTLINE DIMENSION



DIM.	Unit (mm)		Unit (inch)	
	Min	Max	Min	Max
A	1.15	1.35	0.045	0.053
B	2.30	2.80	0.091	0.110
C	0.25	0.40	0.010	0.016
D	1.60	1.80	0.063	0.071
E	0.80	1.10	0.031	0.043
F	0.05	0.25	0.002	0.010

SUGGEST PAD LAYOUT

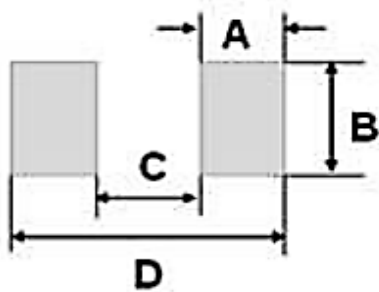

DIM.	Unit (mm)	Unit (inch)
	Typ.	Typ.
A	0.63	0.025
B	0.83	0.033
C	1.60	0.063
D	2.86	0.113

Notice

Specifications of the products displayed herein are subject to change without notice. TSC or anyone on its behalf, assumes no responsibility or liability for any errors or inaccuracies.

Information contained herein is intended to provide a product description only. No license, express or implied, to any intellectual property rights is granted by this document. Except as provided in TSC's terms and conditions of sale for such products, TSC assumes no liability whatsoever, and disclaims any express or implied warranty, relating to sale and/or use of TSC products including liability or warranties relating to fitness for a particular purpose, merchantability, or infringement of any patent, copyright, or other intellectual property right.

The products shown herein are not designed for use in medical, life-saving, or life-sustaining applications. Customers using or selling these products for use in such applications do so at their own risk and agree to fully indemnify TSC for any damages resulting from such improper use or sale.

Mouser Electronics

Authorized Distributor

Click to View Pricing, Inventory, Delivery & Lifecycle Information:

Taiwan Semiconductor:

[1N914BWS](#) [1N4148WS](#) [1N4448WS](#) [1N4148WS RRG](#) [1N4148WS RR](#) [1N4448WS RR](#) [1N4448WS RRG](#)
[1N914BWS RRG](#) [1N914BWS RR](#)