

1SMA59xxBT3G Series, SZ1SMA59xxBT3G Series

1.5 Watt Plastic Surface Mount Zener Voltage Regulators

This complete new line of 1.5 Watt Zener Diodes offers the following advantages.

Features

- Standard Zener Breakdown Voltage Range – 3.3 V to 68 V
- ESD Rating of Class 3 (> 16 kV) per Human Body Model
- Flat Handling Surface for Accurate Placement
- Package Design for Top Slide or Bottom Circuit Board Mounting
- Low Profile Package
- Ideal Replacement for MELF Packages
- AEC-Q101 Qualified and PPAP Capable – SZ1SMA59xxBT3G
- SZ Prefix for Automotive and Other Applications Requiring Unique Site and Control Change Requirements
- These are Pb-Free Devices*

Mechanical Characteristics:

CASE: Void-free, transfer-molded plastic

FINISH: All external surfaces are corrosion resistant with readily solderable leads

MAXIMUM CASE TEMPERATURE FOR SOLDERING PURPOSES:
260°C for 10 seconds

POLARITY: Cathode indicated by molded polarity notch or cathode band

FLAMMABILITY RATING: UL 94 V-0 @ 0.125 in

MAXIMUM RATINGS

| Rating | Symbol | Value | Unit |
|--|-----------------|----------------|------------|
| DC Power Dissipation @ $T_L = 75^\circ\text{C}$, Measured Zero Lead Length (Note 1) Derate above 75°C | P_D | 1.5 20 | W mW/°C |
| Thermal Resistance, Junction-to-Lead | $R_{\theta JL}$ | 50 | °C/W |
| DC Power Dissipation @ $T_A = 25^\circ\text{C}$ (Note 2) Derate above 25°C | P_D | 0.5 4.0 | W mW/°C |
| Thermal Resistance, Junction-to-Ambient | $R_{\theta JA}$ | 250 | °C/W |
| Operating and Storage Temperature Range | T_J, T_{stg} | -65 to +150 | °C |

Stresses exceeding those listed in the Maximum Ratings table may damage the device. If any of these limits are exceeded, device functionality should not be assumed, damage may occur and reliability may be affected.

1. 1 in square copper pad, FR-4 board.
2. FR-4 Board, using ON Semiconductor minimum recommended footprint.

*For additional information on our Pb-Free strategy and soldering details, please download the ON Semiconductor Soldering and Mounting Techniques Reference Manual, SOLDERRM/D.



ON Semiconductor®

www.onsemi.com



SMA
CASE 403D
STYLE 1

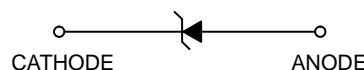

MARKING DIAGRAM



- 8xxB = Device Code (Refer to page 2)
- A = Assembly Location
- Y = Year
- WW = Work Week
- = Pb-Free Package

ORDERING INFORMATION

| Device | Package | Shipping† |
|----------------|------------------|------------------------|
| 1SMA59xxBT3G | SMA (Pb-Free) | 5,000 / Tape & Reel |
| SZ1SMA59xxBT3G | SMA (Pb-Free) | 5,000 / Tape & Reel |

†For information on tape and reel specifications, including part orientation and tape sizes, please refer to our Tape and Reel Packaging Specifications Brochure, BRD8011/D.

DEVICE MARKING INFORMATION

See specific marking information in the device marking column of the Electrical Characteristics table on page 2 of this data sheet.

1SMA59xxBT3G Series, SZ1SMA59xxBT3G Series

ELECTRICAL CHARACTERISTICS ($T_A = 25^\circ\text{C}$ unless otherwise noted, $V_F = 1.2\text{ V Max.}$ @ $I_F = 200\text{ mA}$ for all types)

| Symbol | Parameter |
|----------|------------------------------------|
| V_Z | Reverse Zener Voltage @ I_{ZT} |
| I_{ZT} | Reverse Current |
| Z_{ZT} | Maximum Zener Impedance @ I_{ZT} |
| I_{ZK} | Reverse Current |
| Z_{ZK} | Maximum Zener Impedance @ I_{ZK} |
| I_R | Reverse Leakage Current @ V_R |
| V_R | Reverse Voltage |
| I_F | Forward Current |
| V_F | Forward Voltage @ I_F |
| I_{ZM} | Maximum DC Zener Current |

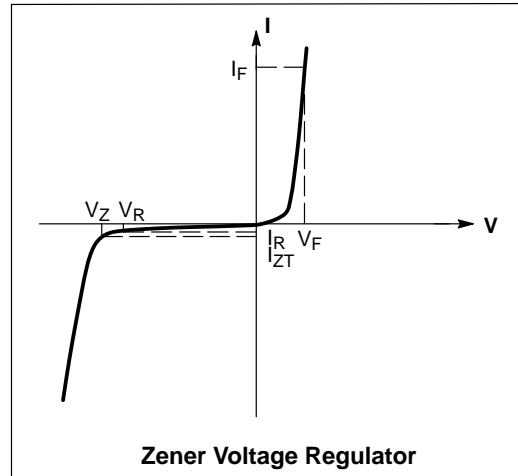

ELECTRICAL CHARACTERISTICS ($T_A = 25^\circ\text{C}$ unless otherwise noted, $V_F = 1.2\text{ V Max.}$ @ $I_F = 200\text{ mA}$ for all types)

| Device* (Note 3) | Device Marking | Zener Voltage (Note 4) | | | | Zener Impedance | | | Leakage Current | | I_{ZM} |
|------------------|----------------|------------------------|-----|-------|------------|---------------------|---------------------|---------------|-----------------|-------|----------|
| | | V_Z (Volts) | | | @ I_{ZT} | Z_{ZT} @ I_{ZT} | Z_{ZK} @ I_{ZK} | I_R @ V_R | | | |
| | | Min | Nom | Max | mA | Ω | Ω | mA | μA | Volts | |
| 1SMA5913BT3G | 813B | 3.13 | 3.3 | 3.47 | 113.6 | 10 | 500 | 1.0 | 50 | 1.0 | 455 |
| 1SMA5914BT3G | 814B | 3.42 | 3.6 | 3.78 | 104.2 | 9.0 | 500 | 1.0 | 35.5 | 1.0 | 417 |
| 1SMA5915BT3G | 815B | 3.70 | 3.9 | 4.10 | 96.1 | 7.5 | 500 | 1.0 | 12.5 | 1.0 | 385 |
| 1SMA5916BT3G | 816B | 4.08 | 4.3 | 4.52 | 87.2 | 6.0 | 500 | 1.0 | 2.5 | 1.0 | 349 |
| 1SMA5917BT3G | 817B | 4.46 | 4.7 | 4.94 | 79.8 | 5.0 | 500 | 1.0 | 2.5 | 1.5 | 319 |
| 1SMA5918BT3G | 818B | 4.84 | 5.1 | 5.36 | 73.5 | 4.0 | 350 | 1.0 | 2.5 | 2.0 | 294 |
| 1SMA5919BT3G | 819B | 5.32 | 5.6 | 5.88 | 66.9 | 2.0 | 250 | 1.0 | 2.5 | 3.0 | 268 |
| 1SMA5920BT3G | 820B | 5.89 | 6.2 | 6.51 | 60.5 | 2.0 | 200 | 1.0 | 2.5 | 4.0 | 242 |
| 1SMA5921BT3G | 821B | 6.46 | 6.8 | 7.14 | 55.1 | 2.5 | 200 | 1.0 | 2.5 | 5.2 | 221 |
| 1SMA5922BT3G | 822B | 7.12 | 7.5 | 7.88 | 50 | 3.0 | 400 | 0.5 | 2.5 | 6.0 | 200 |
| 1SMA5923BT3G | 823B | 7.79 | 8.2 | 8.61 | 45.7 | 3.5 | 400 | 0.5 | 2.5 | 6.5 | 183 |
| 1SMA5924BT3G | 824B | 8.64 | 9.1 | 9.56 | 41.2 | 4.0 | 500 | 0.5 | 2.5 | 7.0 | 165 |
| 1SMA5925BT3G | 825B | 9.5 | 10 | 10.5 | 37.5 | 4.5 | 500 | 0.25 | 2.5 | 8.0 | 150 |
| 1SMA5926BT3G | 826B | 10.45 | 11 | 11.55 | 34.1 | 5.5 | 550 | 0.25 | 0.5 | 8.4 | 136 |
| 1SMA5927BT3G | 827B | 11.4 | 12 | 12.6 | 31.2 | 6.5 | 550 | 0.25 | 0.5 | 9.1 | 125 |
| 1SMA5928BT3G | 828B | 12.35 | 13 | 13.65 | 28.8 | 7.0 | 550 | 0.25 | 0.5 | 9.9 | 115 |
| 1SMA5929BT3G | 829B | 14.25 | 15 | 15.75 | 25 | 9.0 | 600 | 0.25 | 0.5 | 11.4 | 100 |
| 1SMA5930BT3G | 830B | 15.2 | 16 | 16.8 | 23.4 | 10 | 600 | 0.25 | 0.5 | 12.2 | 94 |
| 1SMA5931BT3G | 831B | 17.1 | 18 | 18.9 | 20.8 | 12 | 650 | 0.25 | 0.5 | 13.7 | 83 |
| 1SMA5932BT3G | 832B | 19 | 20 | 21 | 18.7 | 14 | 650 | 0.25 | 0.5 | 15.2 | 75 |
| 1SMA5933BT3G | 833B | 20.9 | 22 | 23.1 | 17 | 17.5 | 650 | 0.25 | 0.5 | 16.7 | 68 |
| 1SMA5934BT3G | 834B | 22.8 | 24 | 25.2 | 15.6 | 19 | 700 | 0.25 | 0.5 | 18.2 | 63 |
| 1SMA5935BT3G | 835B | 25.65 | 27 | 28.35 | 13.9 | 23 | 700 | 0.25 | 0.5 | 20.6 | 56 |
| 1SMA5936BT3G | 836B | 28.5 | 30 | 31.5 | 12.5 | 26 | 750 | 0.25 | 0.5 | 22.8 | 50 |
| 1SMA5937BT3G | 837B | 31.35 | 33 | 34.65 | 11.4 | 33 | 800 | 0.25 | 0.5 | 25.1 | 45 |
| 1SMA5938BT3G | 838B | 34.2 | 36 | 37.8 | 10.4 | 38 | 850 | 0.25 | 0.5 | 27.4 | 42 |
| 1SMA5939BT3G | 839B | 37.05 | 39 | 40.95 | 9.6 | 45 | 900 | 0.25 | 0.5 | 29.7 | 38 |
| 1SMA5940BT3G | 840B | 40.85 | 43 | 45.15 | 8.7 | 53 | 950 | 0.25 | 0.5 | 32.7 | 35 |
| 1SMA5941BT3G | 841B | 44.65 | 47 | 49.35 | 8.0 | 67 | 1000 | 0.25 | 0.5 | 35.8 | 32 |
| 1SMA5942BT3G | 842B | 48.45 | 51 | 53.55 | 7.3 | 70 | 1100 | 0.25 | 0.5 | 38.8 | 29 |
| 1SMA5943BT3G | 843B | 53.2 | 56 | 58.8 | 6.7 | 86 | 1300 | 0.25 | 0.5 | 42.6 | 27 |
| 1SMA5945BT3G | 845B | 64.6 | 68 | 71.4 | 5.5 | 120 | 1700 | 0.25 | 0.5 | 51.7 | 22 |

3. Tolerance and Voltage Regulation Designation – The type number listed indicates a tolerance of $\pm 5\%$.

4. V_Z limits are to be guaranteed at thermal equilibrium.

* Include SZ-prefix devices where applicable.

1SMA59xxBT3G Series, SZ1SMA59xxBT3G Series

RATING AND TYPICAL CHARACTERISTIC CURVES ($T_A = 25^\circ\text{C}$)



Figure 1. Steady State Power Derating



Figure 2. V_Z – 3.3 thru 10 Volts



Figure 3. $V_Z = 12$ thru 68 Volts



Figure 4. Zener Voltage – 3.3 to 12 Volts



Figure 5. Zener Voltage – 12 to 68 Volts



Figure 6. Effect of Zener Voltage

1SMA59xxBT3G Series, SZ1SMA59xxBT3G Series

RATING AND TYPICAL CHARACTERISTIC CURVES ($T_A = 25^\circ\text{C}$)



Figure 7. Capacitance Curve

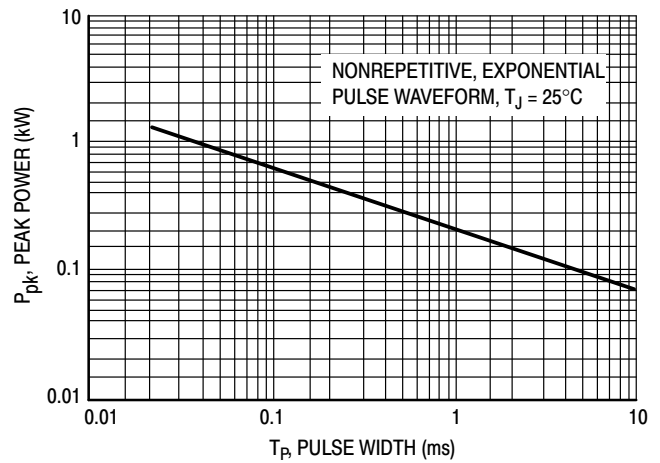

Figure 8. Typical Pulse Rating Curve



Figure 9. Pulse Waveform

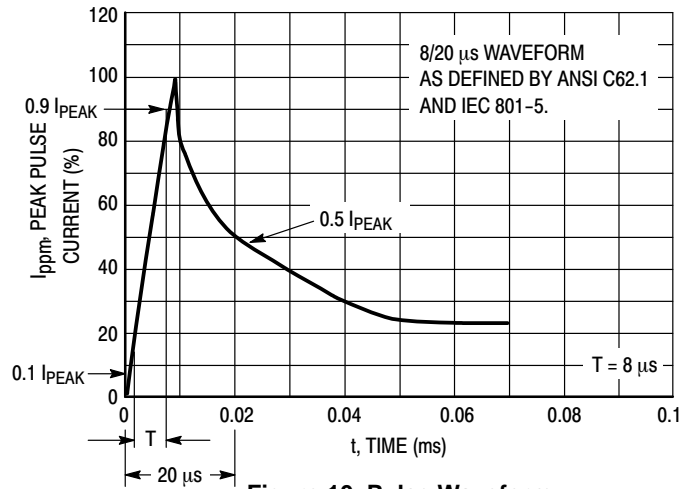

Figure 10. Pulse Waveform

MECHANICAL CASE OUTLINE

PACKAGE DIMENSIONS

ON Semiconductor®



STYLE 1 STYLE 2

SCALE 1:1

SMA CASE 403D ISSUE H

DATE 23 SEP 2015

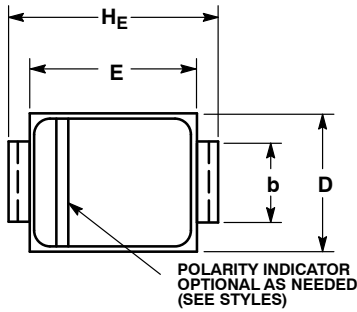

- NOTES:
1. DIMENSIONING AND TOLERANCING PER ANSI Y14.5M, 1982.
 2. CONTROLLING DIMENSION: INCH.
 3. DIMENSION b SHALL BE MEASURED WITHIN DIMENSION L.

| DIM | MILLIMETERS | | | INCHES | | |
|-----|-------------|------|------|--------|-------|-------|
| | MIN | NOM | MAX | MIN | NOM | MAX |
| A | 1.97 | 2.10 | 2.20 | 0.078 | 0.083 | 0.087 |
| A1 | 0.05 | 0.10 | 0.20 | 0.002 | 0.004 | 0.008 |
| b | 1.27 | 1.45 | 1.63 | 0.050 | 0.057 | 0.064 |
| c | 0.15 | 0.28 | 0.41 | 0.006 | 0.011 | 0.016 |
| D | 2.29 | 2.60 | 2.92 | 0.090 | 0.103 | 0.115 |
| E | 4.06 | 4.32 | 4.57 | 0.160 | 0.170 | 0.180 |
| HE | 4.83 | 5.21 | 5.59 | 0.190 | 0.205 | 0.220 |
| L | 0.76 | 1.14 | 1.52 | 0.030 | 0.045 | 0.060 |

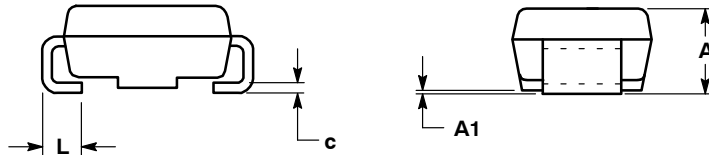

GENERIC MARKING DIAGRAM*

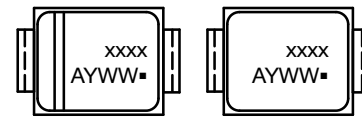

STYLE 1 STYLE 2

- xxxx = Specific Device Code
- A = Assembly Location
- Y = Year
- WW = Work Week
- = Pb-Free Package

*This information is generic. Please refer to device data sheet for actual part marking. Pb-Free indicator, "G" or microdot "▪", may or may not be present.

SOLDERING FOOTPRINT*

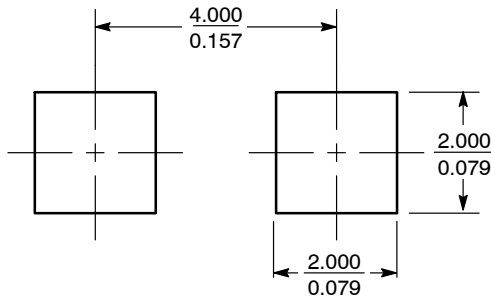

SCALE 8:1 (mm/inches)

*For additional information on our Pb-Free strategy and soldering details, please download the ON Semiconductor Soldering and Mounting Techniques Reference Manual, SOLDERRM/D.

- STYLE 1: STYLE 2:
1. CATHODE (POLARITY BAND)
 2. ANODE
- NO POLARITY

| | | |
|-------------------------|--------------------|--|
| DOCUMENT NUMBER: | 98AON04079D | Electronic versions are uncontrolled except when accessed directly from the Document Repository. Printed versions are uncontrolled except when stamped "CONTROLLED COPY" in red. |
| DESCRIPTION: | SMA | PAGE 1 OF 1 |

ON Semiconductor and ON are trademarks of Semiconductor Components Industries, LLC dba ON Semiconductor or its subsidiaries in the United States and/or other countries. ON Semiconductor reserves the right to make changes without further notice to any products herein. ON Semiconductor makes no warranty, representation or guarantee regarding the suitability of its products for any particular purpose, nor does ON Semiconductor assume any liability arising out of the application or use of any product or circuit, and specifically disclaims any and all liability, including without limitation special, consequential or incidental damages. ON Semiconductor does not convey any license under its patent rights nor the rights of others.

ON Semiconductor and  are trademarks of Semiconductor Components Industries, LLC dba ON Semiconductor or its subsidiaries in the United States and/or other countries. ON Semiconductor owns the rights to a number of patents, trademarks, copyrights, trade secrets, and other intellectual property. A listing of ON Semiconductor's product/patent coverage may be accessed at www.onsemi.com/site/pdf/Patent-Marking.pdf. ON Semiconductor reserves the right to make changes without further notice to any products herein. ON Semiconductor makes no warranty, representation or guarantee regarding the suitability of its products for any particular purpose, nor does ON Semiconductor assume any liability arising out of the application or use of any product or circuit, and specifically disclaims any and all liability, including without limitation special, consequential or incidental damages. Buyer is responsible for its products and applications using ON Semiconductor products, including compliance with all laws, regulations and safety requirements or standards, regardless of any support or applications information provided by ON Semiconductor. "Typical" parameters which may be provided in ON Semiconductor data sheets and/or specifications can and do vary in different applications and actual performance may vary over time. All operating parameters, including "Typicals" must be validated for each customer application by customer's technical experts. ON Semiconductor does not convey any license under its patent rights nor the rights of others. ON Semiconductor products are not designed, intended, or authorized for use as a critical component in life support systems or any FDA Class 3 medical devices or medical devices with a same or similar classification in a foreign jurisdiction or any devices intended for implantation in the human body. Should Buyer purchase or use ON Semiconductor products for any such unintended or unauthorized application, Buyer shall indemnify and hold ON Semiconductor and its officers, employees, subsidiaries, affiliates, and distributors harmless against all claims, costs, damages, and expenses, and reasonable attorney fees arising out of, directly or indirectly, any claim of personal injury or death associated with such unintended or unauthorized use, even if such claim alleges that ON Semiconductor was negligent regarding the design or manufacture of the part. ON Semiconductor is an Equal Opportunity/Affirmative Action Employer. This literature is subject to all applicable copyright laws and is not for resale in any manner.

PUBLICATION ORDERING INFORMATION

LITERATURE FULFILLMENT:

Email Requests to: orderlit@onsemi.com

ON Semiconductor Website: www.onsemi.com

TECHNICAL SUPPORT

North American Technical Support:
Voice Mail: 1 800-282-9855 Toll Free USA/Canada
Phone: 011 421 33 790 2910

Europe, Middle East and Africa Technical Support:

Phone: 00421 33 790 2910

For additional information, please contact your local Sales Representative

Mouser Electronics

Authorized Distributor

Click to View Pricing, Inventory, Delivery & Lifecycle Information:

ON Semiconductor:

[1SMA5913BT3G](#) [1SMA5914BT3](#) [1SMA5914BT3G](#) [1SMA5915BT3](#) [1SMA5915BT3G](#) [1SMA5916BT3](#)
[1SMA5916BT3G](#) [1SMA5917BT3](#) [1SMA5917BT3G](#) [1SMA5918BT3](#) [1SMA5918BT3G](#) [1SMA5919BT3](#)
[1SMA5919BT3G](#) [1SMA5920BT3](#) [1SMA5920BT3G](#) [1SMA5921BT3](#) [1SMA5921BT3G](#) [1SMA5922BT3](#)
[1SMA5922BT3G](#) [1SMA5923BT3](#) [1SMA5923BT3G](#) [1SMA5924BT3](#) [1SMA5924BT3G](#) [1SMA5925BT3](#)
[1SMA5925BT3G](#) [1SMA5926BT3](#) [1SMA5926BT3G](#) [1SMA5927BT3](#) [1SMA5927BT3G](#) [1SMA5928BT3](#)
[1SMA5928BT3G](#) [1SMA5929BT3](#) [1SMA5929BT3G](#) [1SMA5930BT3](#) [1SMA5930BT3G](#) [1SMA5931BT3](#)
[1SMA5931BT3G](#) [1SMA5932BT3](#) [1SMA5932BT3G](#) [1SMA5933BT3](#) [1SMA5933BT3G](#) [1SMA5934BT3](#)
[1SMA5934BT3G](#) [1SMA5935BT3](#) [1SMA5935BT3G](#) [1SMA5936BT3](#) [1SMA5936BT3G](#) [1SMA5937BT3](#)
[1SMA5937BT3G](#) [1SMA5938BT3](#) [1SMA5938BT3G](#) [1SMA5939BT3](#) [1SMA5939BT3G](#) [1SMA5940BT3](#)
[1SMA5940BT3G](#) [1SMA5941BT3](#) [1SMA5941BT3G](#) [1SMA5942BT3](#) [1SMA5942BT3G](#) [1SMA5943BT3](#)
[1SMA5943BT3G](#) [1SMA5944BT3](#) [1SMA5944BT3G](#) [1SMA5945BT3](#) [1SMA5945BT3G](#) [SZ1SMA5925BT3G](#)
[SZ1SMA5915BT3G](#) [SZ1SMA5917BT3G](#) [SZ1SMA5918BT3G](#) [SZ1SMA5920BT3G](#) [SZ1SMA5928BT3G](#)
[SZ1SMA5934BT3G](#) [SZ1SMA5936BT3G](#) [SZ1SMA5945BT3G](#) [1SMA5913BT3](#) [SZ1SMA5929BT3G](#)
[SZ1SMA5927BT3G](#) [SZ1SMA5938BT3G](#) [SZ1SMA5940BT3G](#) [SZ1SMA5933BT3G](#) [SZ1SMA5931BT3G](#)
[SZ1SMA5939BT3G](#) [SZ1SMA5922BT3G](#) [SZ1SMA5937BT3G](#) [SZ1SMA5926BT3G](#) [SZ1SMA5921BT3G](#)
[SZ1SMA5924BT3G](#) [SZ1SMA5935BT3G](#) [SZ1SMA5923BT3G](#) [SZ1SMA5932BT3G](#) [SZ1SMA5919BT3G](#)
[SZ1SMA5916BT3G](#) [SZ1SMA5913BT3G](#) [SZ1SMA5930BT3G](#) [SZ1SMA5942BT3G](#) [SZ1SMA5941BT3G](#)
[SZ1SMA5943BT3G](#) [SZ1SMA5935BT3G-VF01](#)