

PRODUCT NUMBER

71918-YXXZZLF

RoHS COMPATIBLE, SEE NOTE 10

S= SPECIFIC CUSTOMER PLATING OPTION.

COLOR OPTION, SEE NOTE 1

TOTAL NB OF POSITIONS, SEE SHEET 2

LATCHING

GOLD/GXT PLATING
SEE SHEET 2

- 0= WITHOUT LATCH WITH DIM "A" 2.9mm
 - 1= STANDARD LATCH WITH DIM "A" 2.9mm
 - 2= LOW PROFILE LATCH WITH DIM "A" 2.9mm
 - 5= LOW PROFILE LATCH WITH DIM "A" 3.94mm
 - 6= STANDARD LATCH WITH DIM "A" 3.94mm
- GXT PLATING

FULL TIN PLATED
SEE SHEET 2

- T= STANDARD LATCH WITH DIM "A" 2.9mm

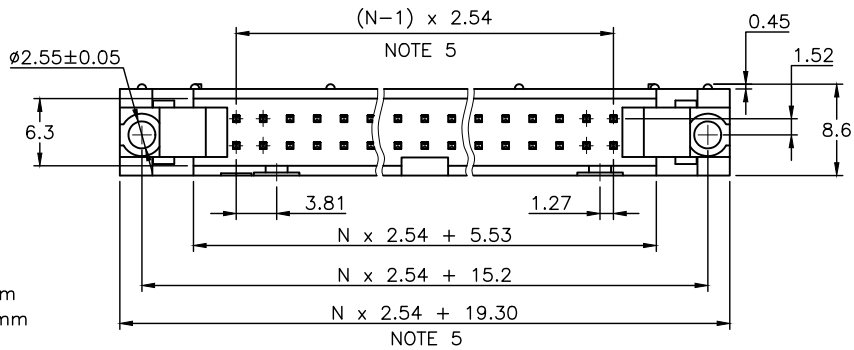

NOTES:

- 1 - HOUSING MATERIAL: GLASS FILLED THERMOPLASTIC UL94V-0 TRIANGLE INDICATES POSITION 1
= STANDARD COLOR GREY
B = OPTION COLOR BLACK
- 2 - PIN MATERIAL : PHOSPHOR BRONZE
- 3 - PRODUCT PACKAGED IN TUBES
- 4 - 40N MIN LATCH RETENTION FORCE AT FIRST EXTRACTION
- 5 - TO DETERMINE DIMENSIONS :
N = NUMBER OF POSITIONS PER ROW
EXAMPLE : 8 POS N x 2.54 = 20.32mm
- 6 - NO CENTRAL SLOT ON POSITIONS 6 & 8
- 7 - NO LEFT POLARIZATION ON POSITIONS 06, 08, 10, 14.
- 8 - NO GROOVE ON POSITIONS 06, 08, 10, 14, 30, 34
- 9 - 4.5mm SOLDER TAIL
ORDER 71918-4XX (WITH STANDARD LATCH ONLY)
- 10 - RoHS COMPATIBLE PRODUCT SPECIFICATIONS

a - PLATING:

- "LF" MEANS THE PRODUCT IS LEAD-FREE, 2µm MINIMUM MATTE TIN OVER 1.27µm MINIMUM NICKEL UNDERPLATE.

b - MANUFACTURING PROCESS COMPATIBILITY

- THE HOUSING WILL WITHSTAND EXPOSURE TO 260°C ±5°C SOLDER BATH TEMPERATURE FOR 5 SECONDS IN A WAVE SOLDER APPLICATION WITH A 1.6mm MIN THICK CIRCUIT BOARD.

c - LABELING:

- MEETS PACKAGING SPECS AS PER GS-14-920

d - LEGAL STATEMENT: SEE GS-47-0004.

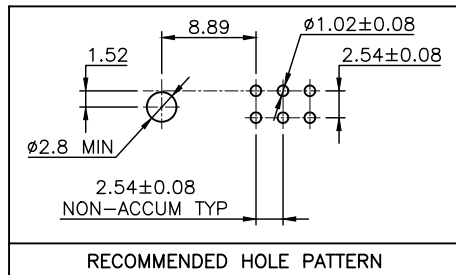
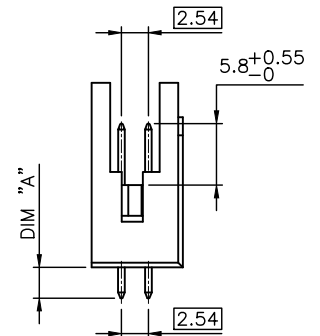
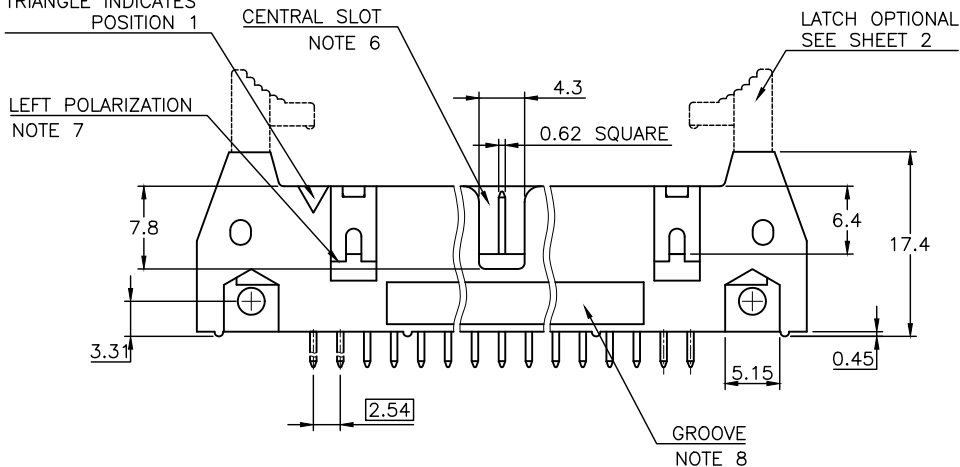

mat'l. code		surface		tolerance		projection		product family	
SEE NOTES		ISO 1302 ✓		ISO 406 ISO 1101		mm		QUICKIE	
ltr	ecn no	dr	date	tolerances unless otherwise specified		mm		title	
AG	F-37618	LMU	20.07.09	angles	linear	.X ±0.3 .XX ±0.13 .XXX ±0.05		SHR.EL.HEADER STR DR TMT	
AB	B-17853	LMU	14.06.05			scale 2:1		dwg no	
AC	B-19091	LMU	14.10.16	dr	D.LE	01.01.24		sheet 1 of 2	
AD	B-20412	BVE	15.03.10	engr	JM.C	01.01.24		size	
AE	F-23514	LMU	16.03.14	chr	JF.N	01.01.24		71918	
AF	F-37618	LMU	20.07.09	appd	JM.C	01.01.24		A3	
sheet	revision	AG	AA					type	
index	sheet	1	2					CUSTOMER Drawing	



Copyright FCJ

PRODUCT NUMBER	SIZE	LATCHING AVAILABILITY	MISSING PIN POSITIONS
71918-X06(B)LF	2x3	0/1/2/5/6/T	
71918-X08(B)LF	2x4	0/1/2/5/6/T	
71918-X10(B)LF	2x5	0/1/2/5/6/T	
71918-X14(B)LF	2x7	0/1/2/5/6/T	
71918-X16(B)LF	2x8	0/1/2/5/6/T	
71918-X18(B)LF	2x9	0/1/2/5/6/T	
71918-X20(B)LF	2x10	0/1/2/5/6/T	
71918-X26(B)LF	2x13	0/1/2/5/6/T	
71918-X27(B)LF	2x13	0/1/2/5/6/T	21;22
71918-X28(B)LF	2x13	0/1/2/5/6/T	5 to 12
71918-X30(B)LF	2x15	0/1/2/5/6/T	
71918-X34(B)LF	2x17	0/1/2/5/6/T	
71918-X35(B)LF	2x17	0/1/2/5/6/T	2;3
71918-X36(B)LF	2x17	0/1/2/5/6/T	11to16 & 19to24
71918-X40(B)LF	2x20	0/1/2/5/6/T	
71918-X44(B)LF	2x22	0/1/2/5/6/T	
71918-X45(B)LF	2x22	0/1/2/5/6/T	9;10;23;24
71918-X50(B)LF	2x25	0/1/2/5/6/T	
71918-X51(B)LF	2x25	0/1/2/5/6/T	39 to 46
71918-X60(B)LF	2x30	0/1/2/5/6/T	
71918-X64(B)LF	2x32	0/1/2/5/6/T	

PLATING FOR LATCHING CODE 0/1/2/5/6:
 0.76µm GOLD/GXT
 (PdNi WITH GOLD FLASH) ON CONTACT AREA
 2µm MIN MATTE TIN ON TAIL
 UNDERPLATE : 1.27µm Ni MIN

PLATING FOR LATCHING CODE T:
 2µm MIN FULL MATTE TIN ALL OVER
 UNDERPLATE : 1.27µm Ni MIN

LATCHING FEATURES :

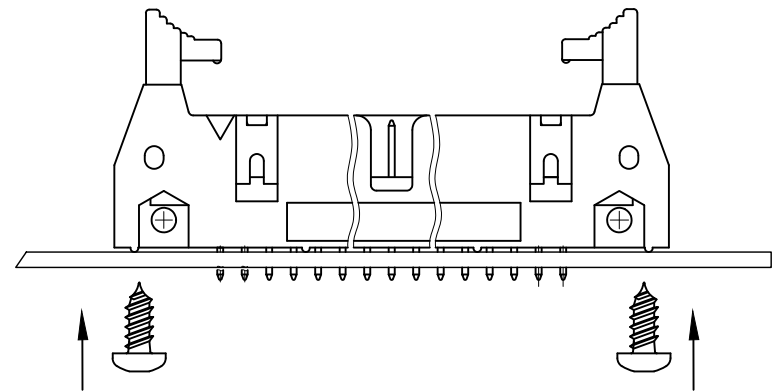
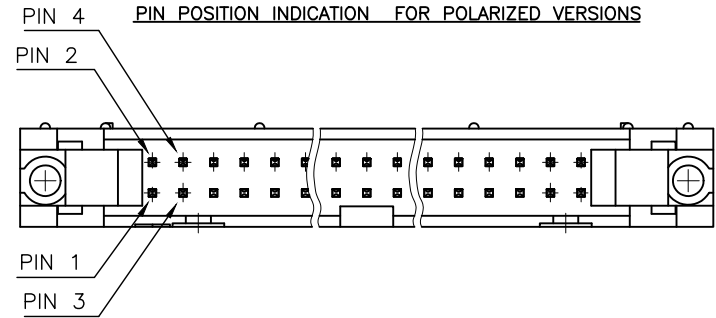
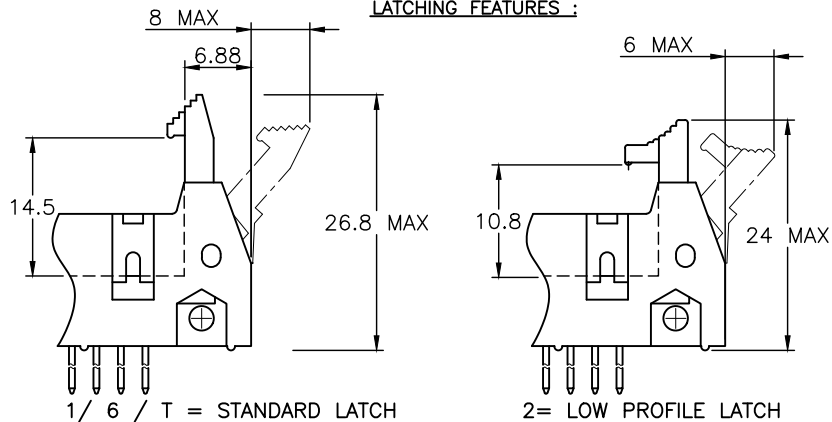

WHEN THE CONNECTORS NEED TO BE FIXED ON THE PCB'S
 THE STAINLESS SCREWS REF TC POZI DIN7981 Ø2.9 X 6.5MM
 TO BE USED

mat'l. code		surface ISO 1302 ✓		tolerance ISO 406 ISO 1101		projection mm		product family QUICKIE	
ltr	ecn no	dr	date	tolerances unless otherwise specified		mm		title SHR.EL.HEADER STR DR TMT	
Y	F-23514	LMU	16.03.14	angles	linear	.X ±0.3	scale 2:1		
AA	F37618	LMU	20.07.09			.XX ±0.15			
						.XXX ±0.05	 dwg no 71918 sheet 2 of - size A3 type CUSTOMER Drawing		
				dr	D.LE	01.01.24			
V	B-16776	LMU	14.01.23	engr	JM.C	01.01.24			
W	B-19091	LMU	14.10.16	chr	JF.N	01.01.24			
X	B-20412	BVE	15.03.10	appd	JM.C	01.01.24			
sheet index	revision sheet								