

APPROVED: \_\_\_\_\_  
 DATE: \_\_\_\_\_ TITLE: \_\_\_\_\_

Rev	AWO #	Description	Date	Appr
-		RELEASED	5/22/15	
A		UPDATE DIM.	9/24/19	AY/NL

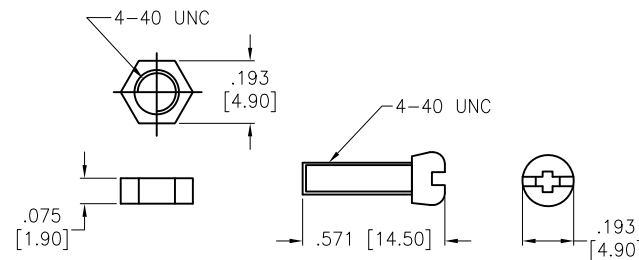
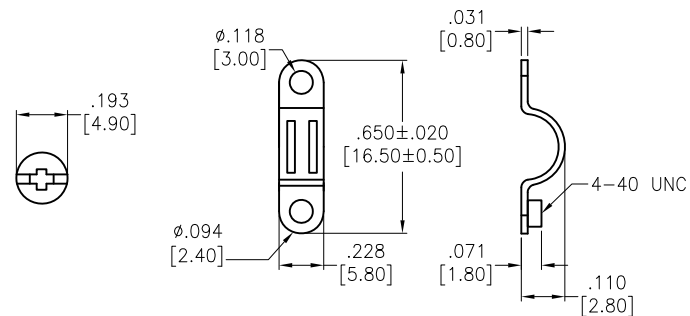
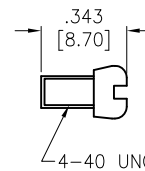
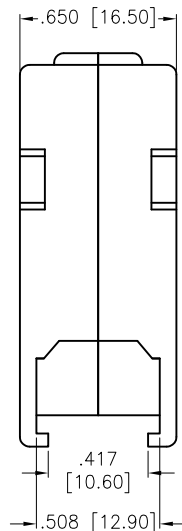
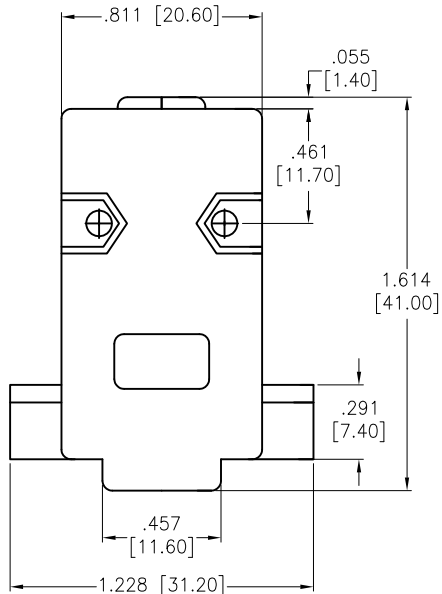
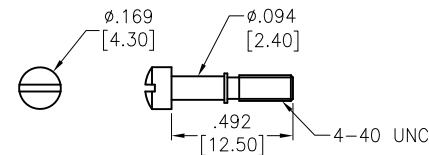
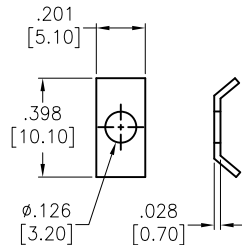
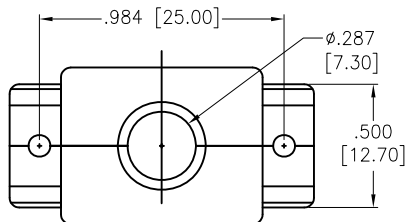

**SPECIFICATIONS:**

Material:  
 Insulator: ABS, rated UL 94HB  
 Insulator color: Chrome Plastic  
 Hardware: Steel, Chromate plated  
 Environmental:  
 Lead free, RoHS compliant



UNLESS OTHERWISE SPECIFIED  
 ALL DIMENSIONS ARE INCHES [MM]  
 TOLERANCES: EXCEPT AS NOTED

INCHES		HOLES	
.X	± .10	Ø.X	± .10
.XX	± .020	Ø.XX	± .015
.XXX	± .015	Ø.XXX	± .010

**ADAM TECH INTERCONNECTS**  
 909 Rahway Avenue,  
 Union, NJ 07083  
 Phone: 908-687-5000  
 Fax: 908-687-5710

APPROVALS		DATE
DRAWN	HR	5/22/15
CHECKED	LL	5/22/15
APPROVED		

TITLE			
D-SUB HOOD, SHORT SCREWS			
SIZE	PART NO.	REV.	
X	DE09-HD-PN-SS	A	
REF:	S00064T	SCALE:	NTS
		SHEET 1 OF 1	