



# TAOGLAS®



# Datasheet

## Apex Hinged TG.30

**Part No:**  
TG.30.8113

**Features:**

600-6000MHz

Covers 5G/4G Bands

Typical 50%+ Efficiency and 3dBi+ Peak Gain

Dipole Swivel Terminal Antenna

Hinged 90° termination with SMA(M) Connector

RoHS and REACH Compliant

1. Introduction	3
2. Specifications	4
3. Antenna Characteristics	7
4. Radiation Patterns	9
5. Mechanical Drawing	75
6. Packaging	76
<hr/>	
Changelog	77

Taoglas makes no warranties based on the accuracy or completeness of the contents of this document and reserves the right to make changes to specifications and product descriptions at any time without notice. Taoglas reserves all rights to this document and the information contained herein. Reproduction, use or disclosure to third parties without express permission is strictly prohibited.



# 1. Introduction



The hinged Apex TG.30 is a Wideband Dipole 5G/4G Antenna – is primarily designed for use with 5G/4G modules, routers and devices that require the highest possible efficiency and peak gain to deliver best in class throughput on all major cellular bands worldwide between 600MHz and 6GHz.

The antenna is a ground plane independent antenna with a SMA (M) connector and swivel mechanism that allows the antenna part to be rotated. The Apex exhibits high efficiency across the wide spectrum and is backward compatible with 2G and 3G cellular applications such as NB-IoT, Cat-M, LTE, UMTS, Wi-Fi and even has GPS included for Assisted GPS and/or E911 applications.

Typical Applications include:

- Routers and Gateways
- Access Points
- Remote Monitoring

With very high efficiency on every cellular band globally it is an ideal solution for any device requiring high, reliable performance. It is also guaranteed to meet any type approval or carrier certification requirements from a RF standpoint. It is an omni-directional antenna and the radiation patterns display this and are stable across all bands.

It has a quality robust UV resistant housing for use with wireless terminals. The swivel and hinge mechanism allows the antenna part itself to be orientated in different directions and can help avoid touching off other antennas or objects close by as well as helping with isolation by orientating the antenna in different directions in MIMO systems for when other TG.30 antennas are present on the same device.

This patented antenna is available in White and Black versions. The antenna blade can swivel 90 degrees from the connector accommodating different installation environments. It is also available with Straight and Right Angle connectors. For further information please contact your regional Taoglas customer support team.

## 2. Specifications

5G/4G Electrical								
Band	Frequency (MHz)		Efficiency (%)	Average Gain (dB)	Peak Gain (dBi)	VSWR	Impedance	Polarization
5G NR/4G Band 5,8,12,13,14,17,18,20, 26,27,28, 29,71	617~960	Bent_Freespace	57	-2.8	2.6	3 Max	50Ω	Linear
		Straight_Freespace	54	-3.0	3.0			
		Bent_On_Edge_30X30cm_GP	53	-3.1	2.8			
		Straight_On_Edge_30X30cm_GP	53	-3.2	2.7			
		Bent_In_Centre_30X30cm_GP	19	-7.7	1.4			
		Straight_In_Centre_30X30cm_GP	56	-2.9	2.0			
5G NR/4G Band 21,32,74,75,76	1427~1518	Bent_Freespace	50	-3.3	5.6			
		Straight_Freespace	50	-3.2	4.8			
		Bent_On_Edge_30X30cm_GP	66	-2.0	2.5			
		Straight_On_Edge_30X30cm_GP	66	-1.9	3.1			
		Bent_In_Centre_30X30cm_GP	67	-2.0	7.2			
		Straight_In_Centre_30X30cm_GP	55	-3.3	5.9			
4G/3G Band 1,2,3,4,9,23,25,35,39,66	1710~2200	Bent_Freespace	80	-1.0	4.3			
		Straight_Freespace	78	-1.1	4.0			
		Bent_On_Edge_30X30cm_GP	66	-1.8	3.0			
		Straight_On_Edge_30X30cm_GP	67	-1.7	3.9			
		Bent_In_Centre_30X30cm_GP	64	-1.9	7.8			
		Straight_In_Centre_30X30cm_GP	68	-1.7	3.2			
Wi-Fi 2400	2400~2500	Bent_Freespace	68	-1.7	4.2			
		Straight_Freespace	62	-2.1	3.3			
		Bent_On_Edge_30X30cm_GP	62	-2.1	3.9			
		Straight_On_Edge_30X30cm_GP	59	-2.3	3.4			
		Bent_In_Centre_30X30cm_GP	31	-5.1	3.1			
		Straight_In_Centre_30X30cm_GP	31	-5.3	2.5			
4G/3G Band 7,38,41	2490~2690	Bent_Freespace	69	-1.6	4.4			
		Straight_Freespace	61	-2.2	4.7			
		Bent_On_Edge_30X30cm_GP	50	-2.9	4.6			
		Straight_On_Edge_30X30cm_GP	49	-3.1	4.7			
		Bent_In_Centre_30X30cm_GP	56	-2.7	7.1			
		Straight_In_Centre_30X30cm_GP	39	-4.3	7.1			
5G NR/4G Band 22,42,43,48,77,78	3300~3800	Bent_Freespace	63	-2.2	6.5			
		Straight_Freespace	60	-2.4	5.7			
		Bent_On_Edge_30X30cm_GP	48	-3.7	5.5			
		Straight_On_Edge_30X30cm_GP	47	-3.7	4.2			
		Bent_In_Centre_30X30cm_GP	43	-4.2	6.8			
		Straight_In_Centre_30X30cm_GP	40	-4.5	5.5			

<b>LTE5200/ Wi-Fi 5800</b>	5150~5925	Bent_Freespace	66	-1.9	5.7			
		Straight_Freespace	63	-2.1	6.5			
		Bent_On_Edge_30X30cm_GP	42	-3.9	4.7			
		Straight_On_Edge_30X30cm_GP	42	-3.9	4.3			
		Bent_In_Centre_30X30cm_GP	35	-4.9	7.1			
		Straight_In_Centre_30X30cm_GP	40	-4.3	8.4			
<b>Mechanical</b>								
Casing	UV Resistant PC/ABS							
Flammability Rating	UL-94							
Connector	SMA Male Hinged 90°							
<b>Environmental</b>								
Temperature Range	-40°C to 85°C							
Humidity	Non-condensing 65°C 95% RH							

5G/4G Bands			
Band Number	5G NR / FR1 / LTE / LTE-Advanced / WCDMA / HSPA / HSPA+ / TD-SCDMA		
	Uplink	Downlink	Covered
1	UL: 1920 to 1980	DL: 2110 to 2170	✓
2	UL: 1850 to 1910	DL: 1930 to 1990	✓
3	UL: 1710 to 1785	DL: 1805 to 1880	✓
4	UL: 1710 to 1755	DL: 2110 to 2155	✓
5	UL: 824 to 849	DL: 869 to 894	✓
7	UL: 2500 to 2570	DL: 2620 to 2690	✓
8	UL: 880 to 915	DL: 925 to 960	✓
9	UL: 1749.9 to 1784.9	DL: 1844.9 to 1879.9	✓
11	UL: 1427.9 to 1447.9	DL: 1475.9 to 1495.9	✓
12	UL: 699 to 716	DL: 729 to 746	✓
13	UL: 777 to 787	DL: 746 to 756	✓
14	UL: 788 to 798	DL: 758 to 768	✓
17	UL: 704 to 716	DL: 734 to 746	✓
18	UL: 815 to 830	DL: 860 to 875	✓
19	UL: 830 to 845	DL: 875 to 890	✓
20	UL: 832 to 862	DL: 791 to 821	✓
21	UL: 1447.9 to 1462.9	DL: 1495.9 to 1510.9	✓
22	UL: 3410 to 3490	DL: 3510 to 3590	✓
23	UL: 2000 to 2020	DL: 2180 to 2200	✓
24	UL: 1625.5 to 1660.5	DL: 1525 to 1559	✓
25	UL: 1850 to 1915	DL: 1930 to 1995	✓
26	UL: 814 to 849	DL: 859 to 894	✓
27	UL: 807 to 824	DL: 852 to 869	✓
28	UL: 703 to 748	DL: 758 to 803	✓
29	UL: -	DL: 717 to 728	✓
30	UL: 2305 to 2315	DL: 2350 to 2360	✓
31	UL: 452.5 to 457.5	DL: 462.5 to 467.5	✗
32	UL: -	DL: 1452 - 1496	✓
35		1850 to 1910	✓
38		2570 to 2620	✓
39		1880 to 1920	✓
40		2300 to 2400	✓
41		2496 to 2690	✓
42		3400 to 3600	✓
43		3600 to 3800	✓
48		3550 to 3700	✓
66	UL: 1710-1780	DL: 2110-2200	✓
71		617 to 698	✓
74/75/76		1427 to 1518	✓
78		3300 to 3800	✓
79		4400 to 5000	✗
85	698-716	728-746	✓

## 3. Antenna Characteristics

### 3.1 Return Loss

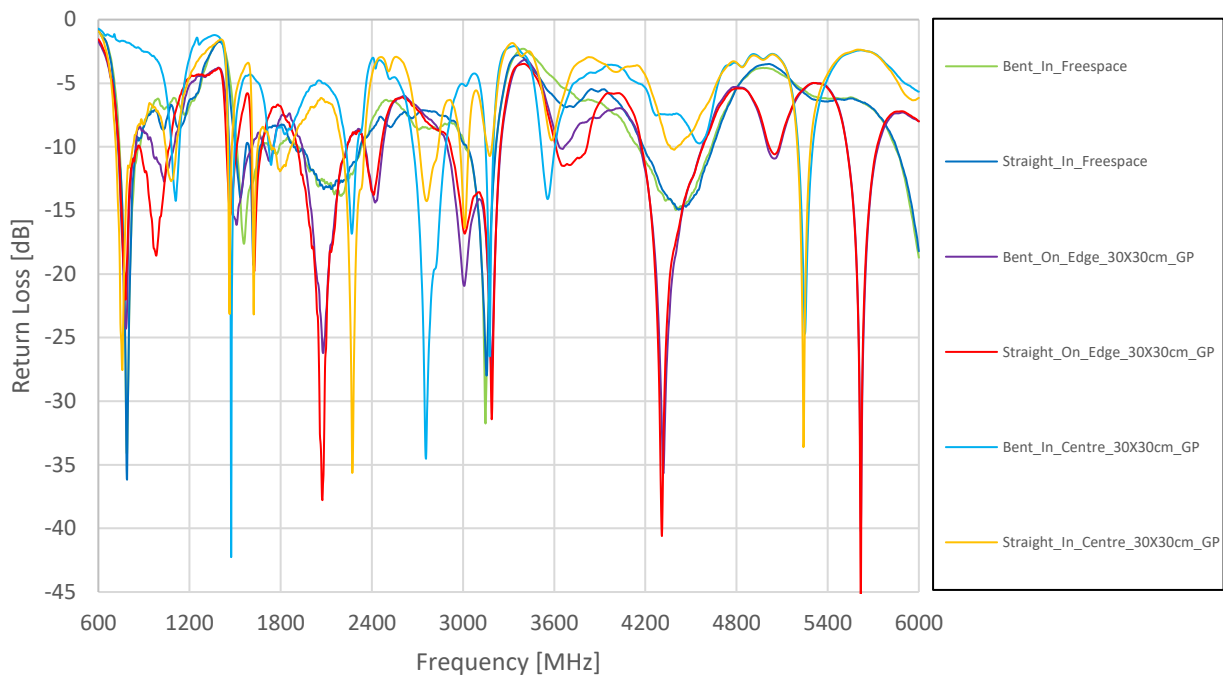

### 3.2 Efficiency

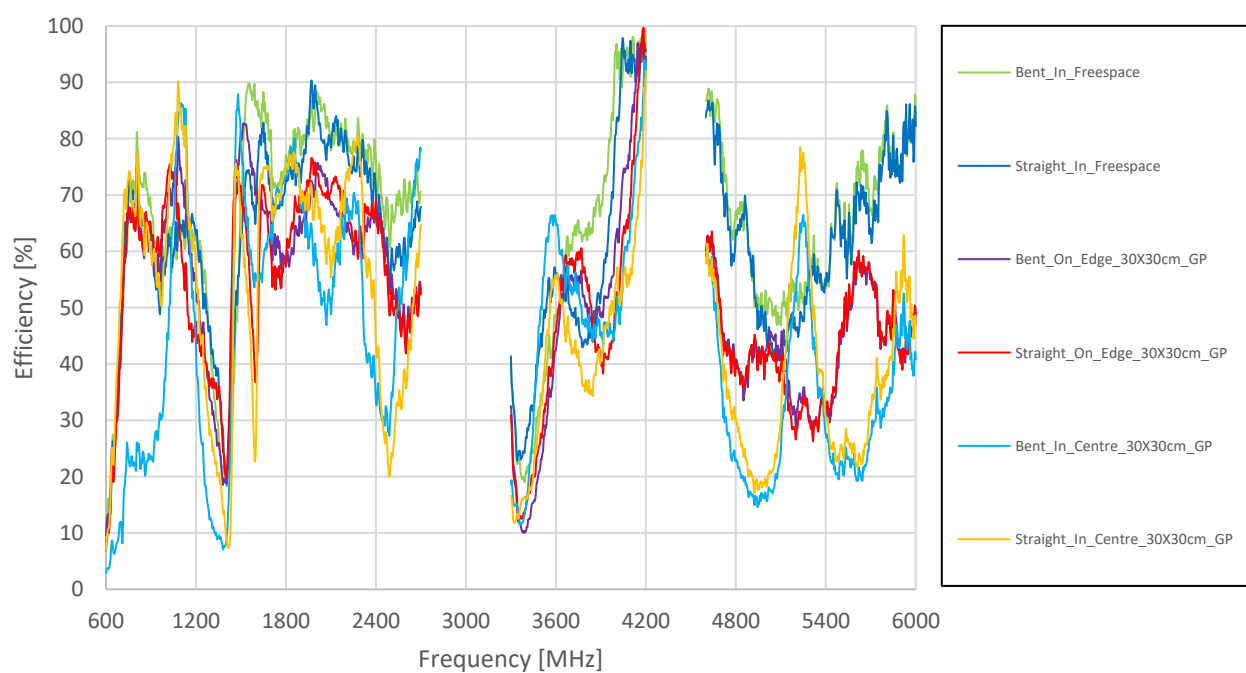

### 3.3 Average Gain

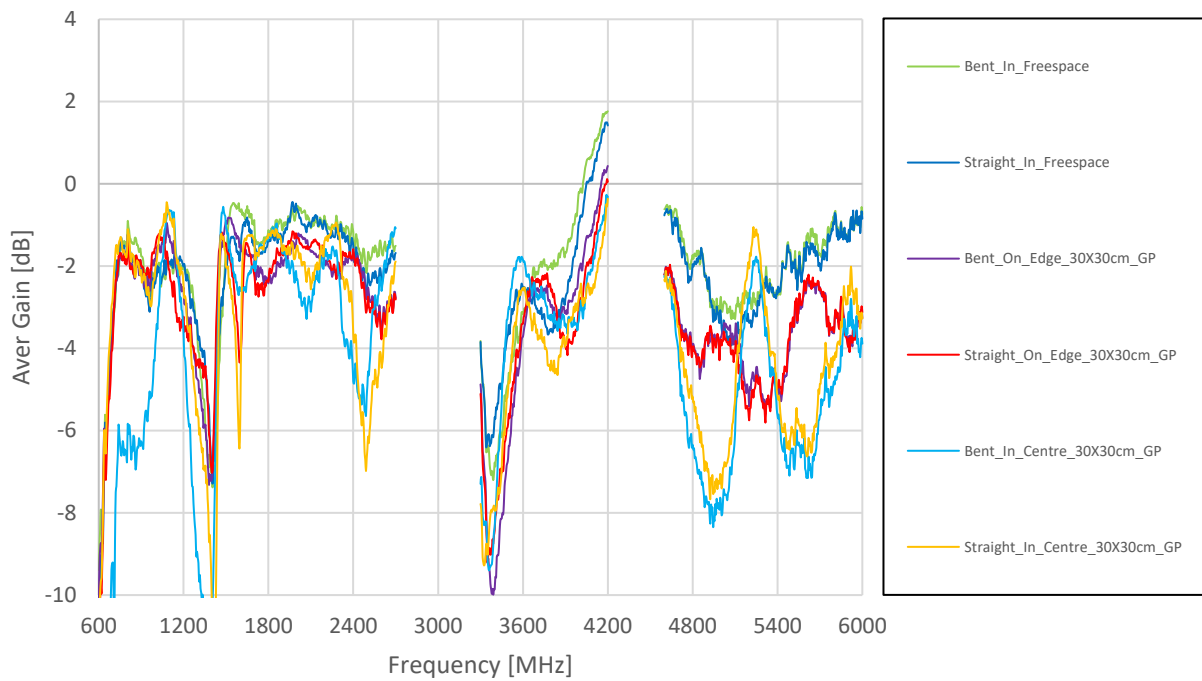

### 3.4 Peak Gain

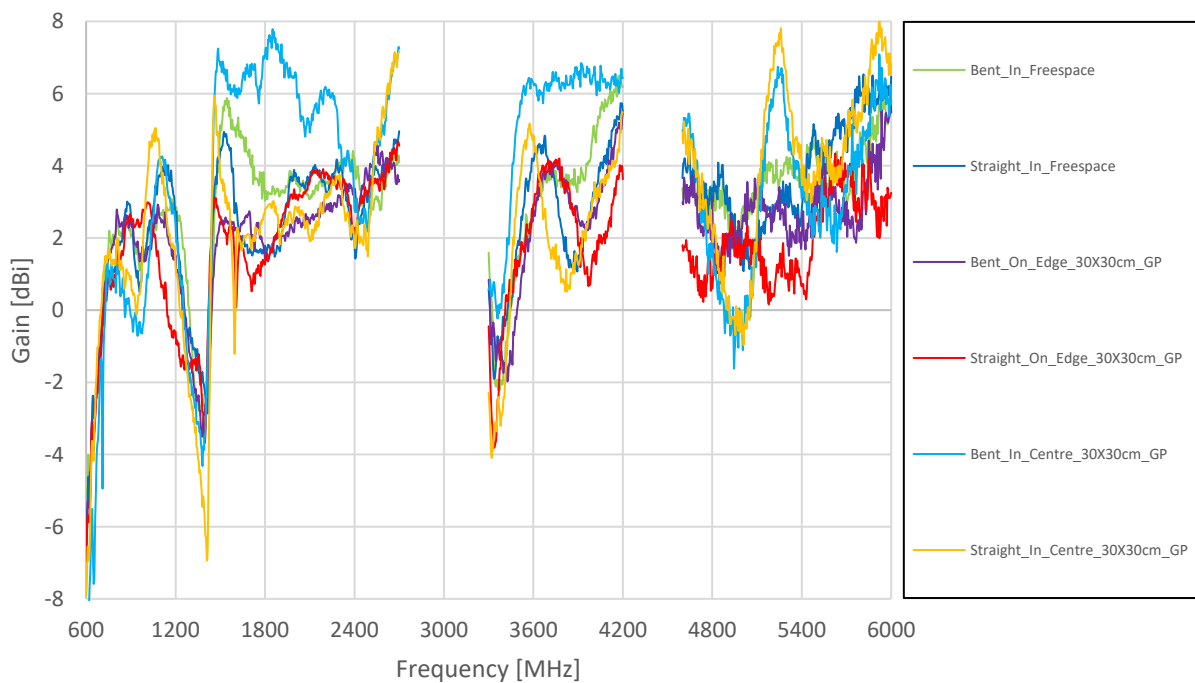



## 4. Radiation Patterns

### 4.1 Test Setup – Bent in Freespace

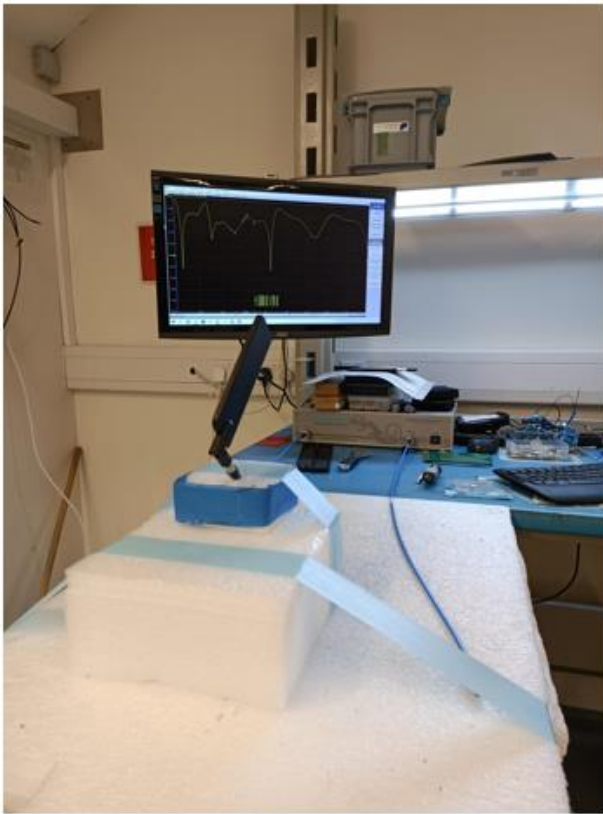

VNA Setup - Bent in Free space

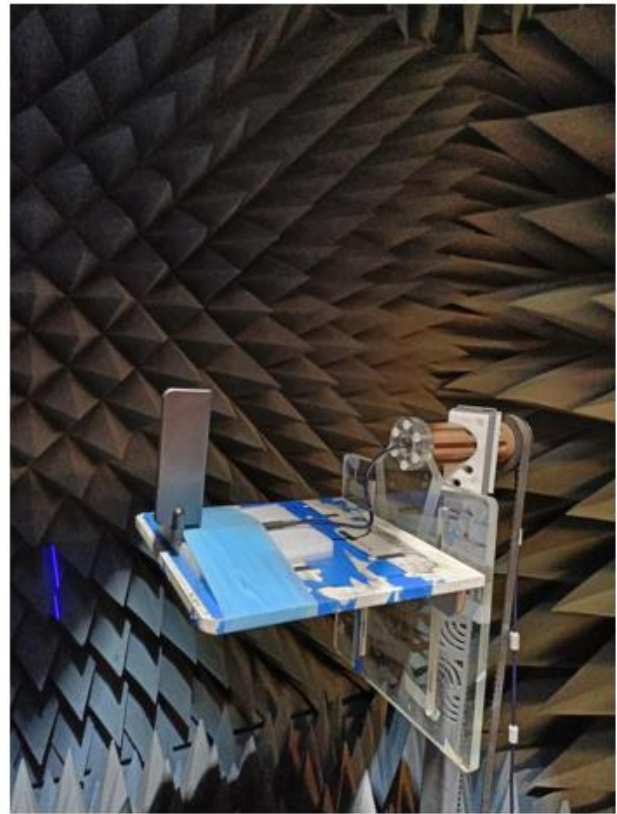

Chamber Setup - Bent in Free space

4.2 650MHz Bent\_In\_Freespace 2D & 3D Radiation Patterns

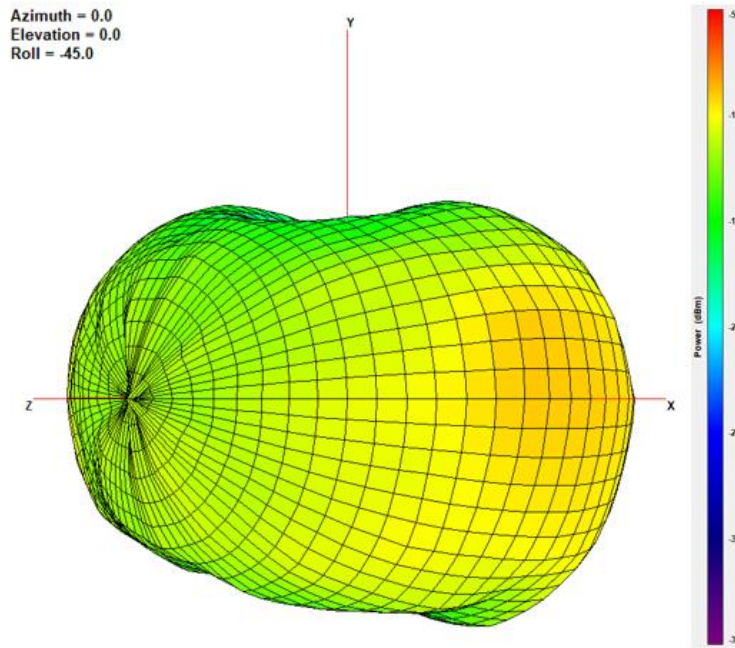

XY Plane

XZ Plane

YZ Plane

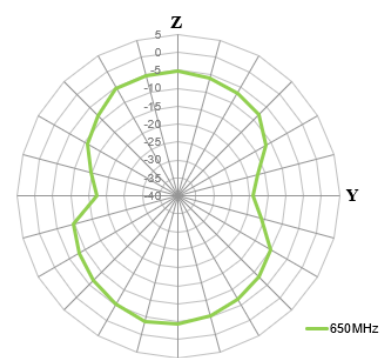
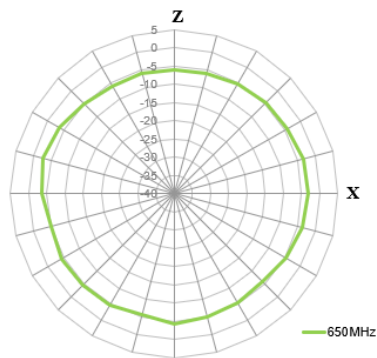
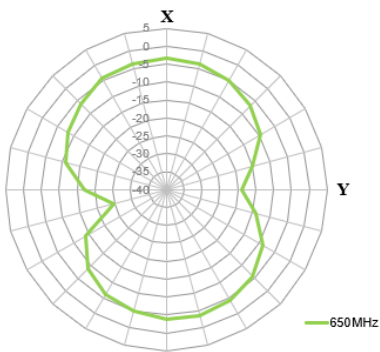

# 750MHz

Azimuth = 0.0  
Elevation = 0.0  
Roll = -45.0

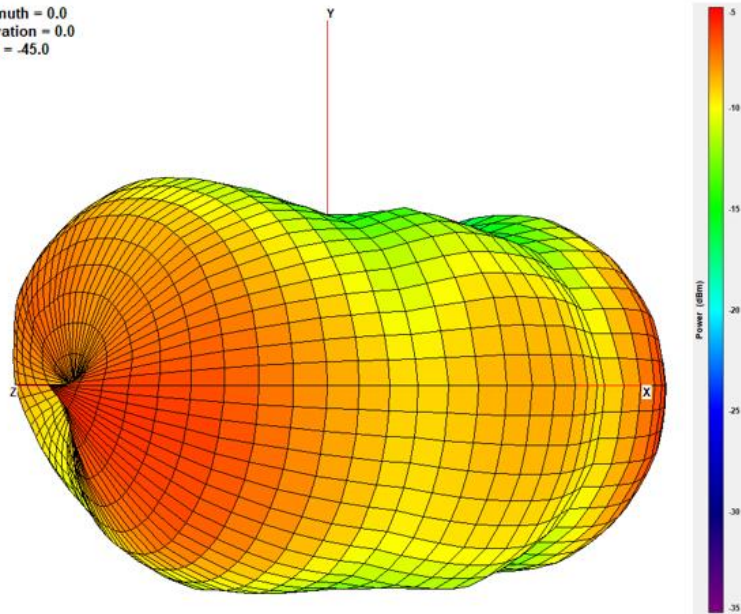

XY Plane

XZ Plane

YZ Plane

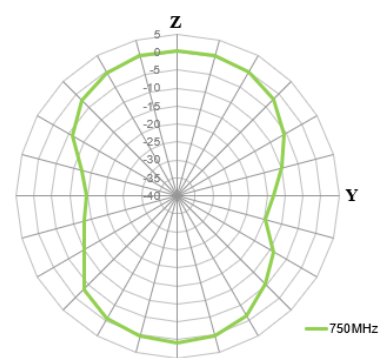
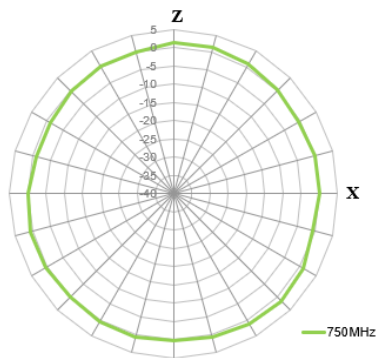
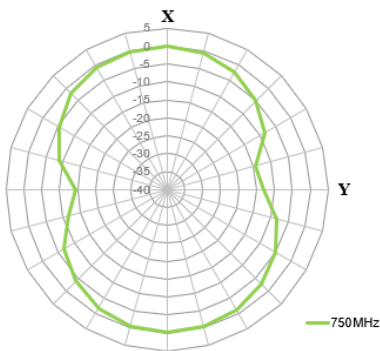

# 890MHz

Azimuth = 0.0  
Elevation = 0.0  
Roll = -45.0

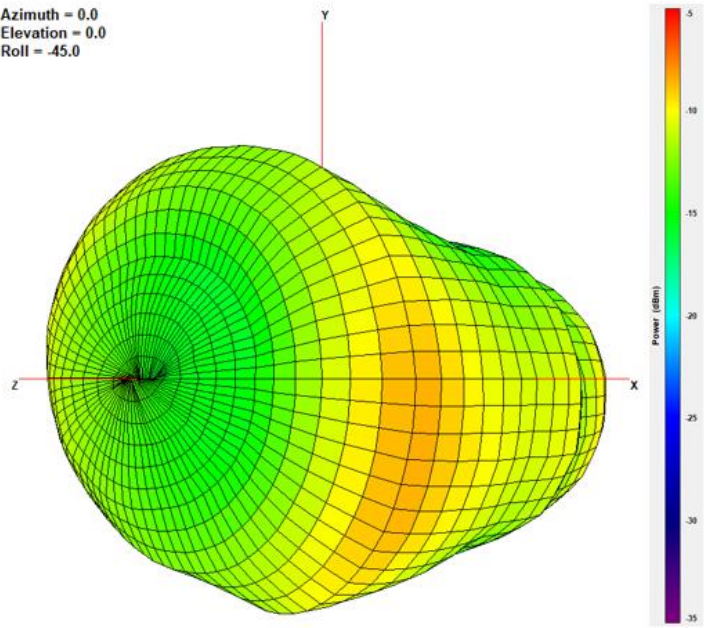

XY Plane

XZ Plane

YZ Plane

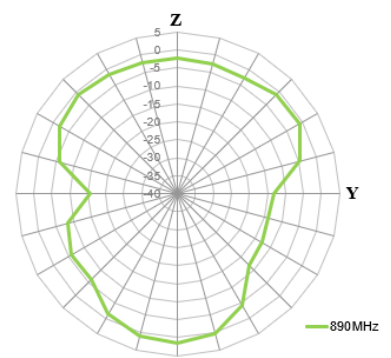
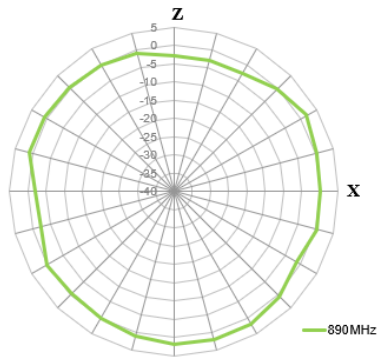
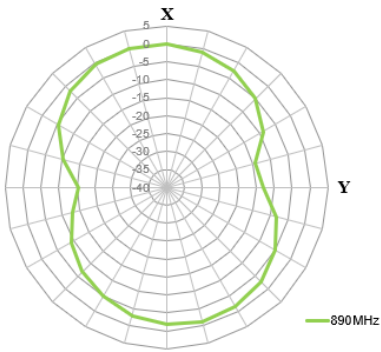

# 1470MHz

Azimuth = 0.0  
Elevation = 0.0  
Roll = -45.0

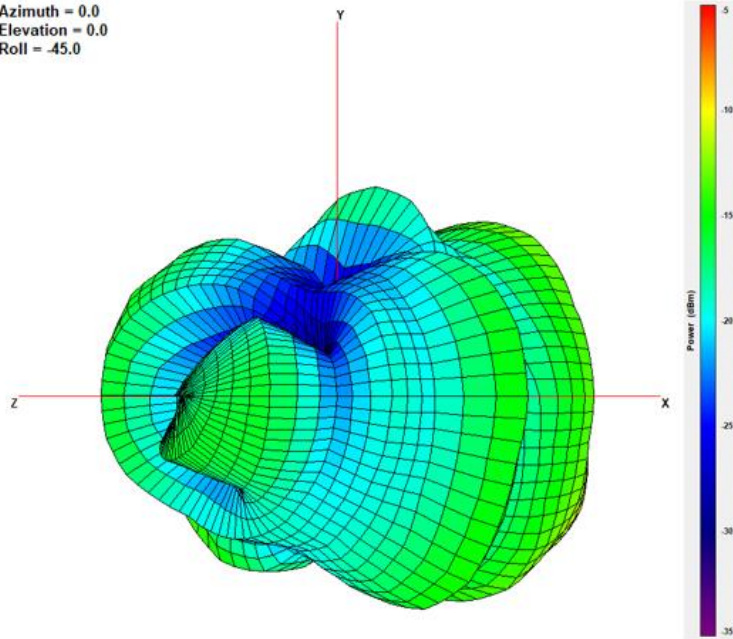

XY Plane

XZ Plane

YZ Plane

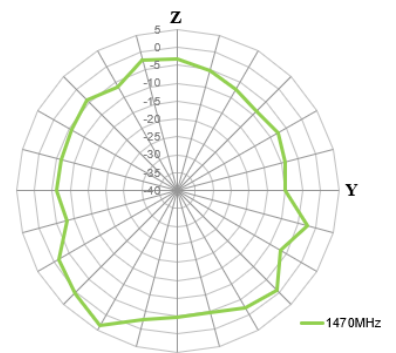
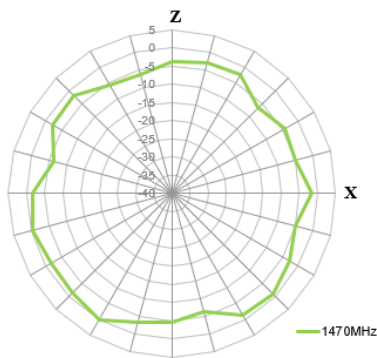
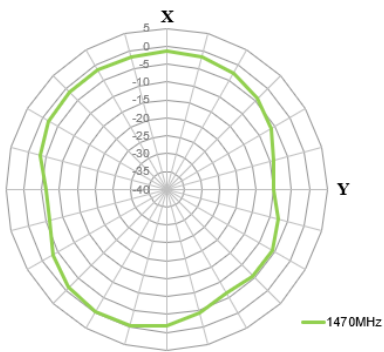

# 1805MHz

Azimuth = 0.0  
Elevation = 0.0  
Roll = -45.0

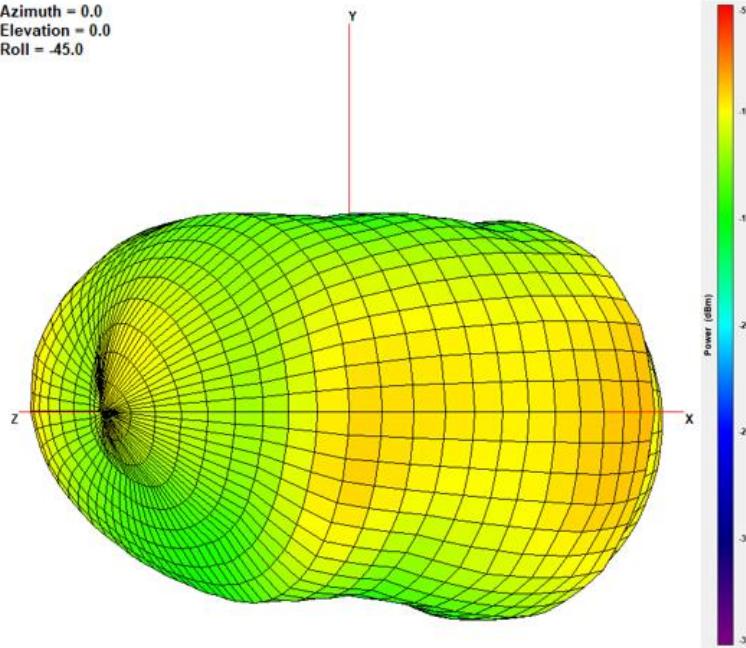

XY Plane

XZ Plane

YZ Plane

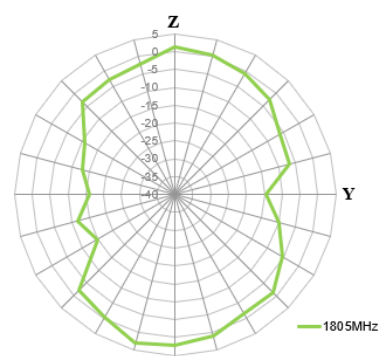
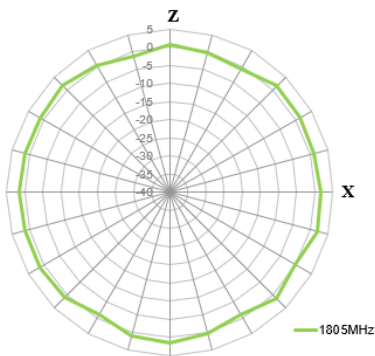
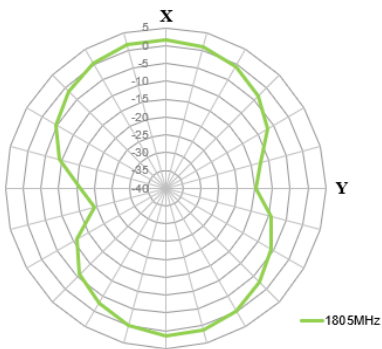

# 1920MHz

Azimuth = 0.0  
 Elevation = 0.0  
 Roll = -45.0

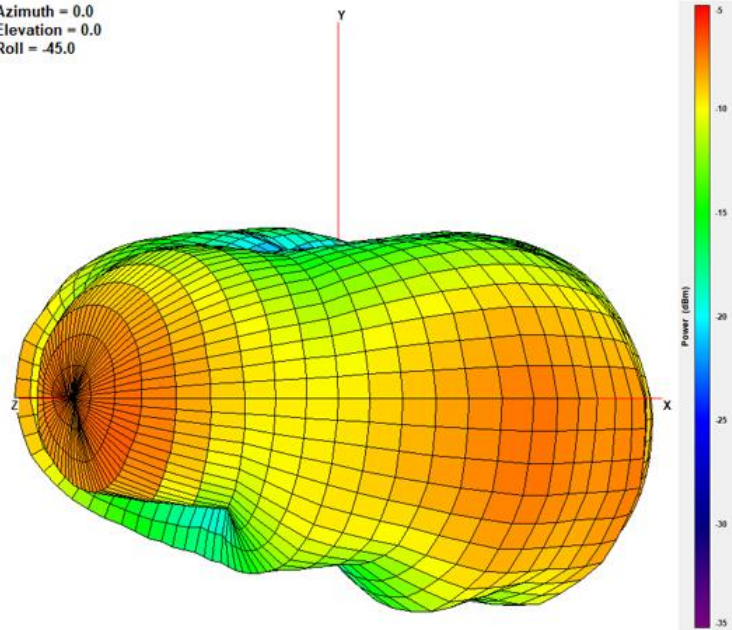

XY Plane

XZ Plane

YZ Plane

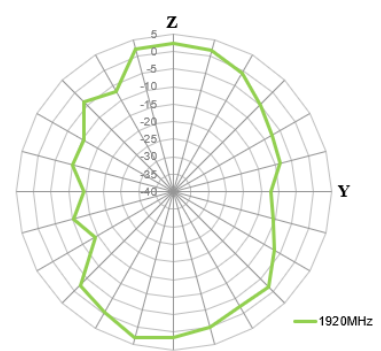
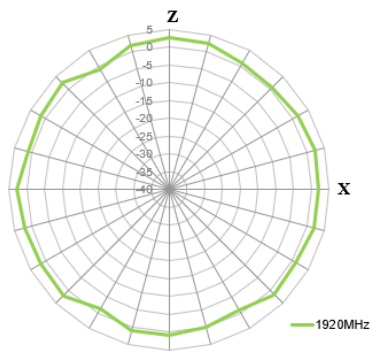
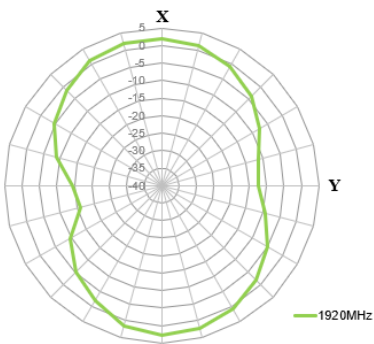

# 1990MHz

Azimuth = 0.0  
Elevation = 0.0  
Roll = -45.0

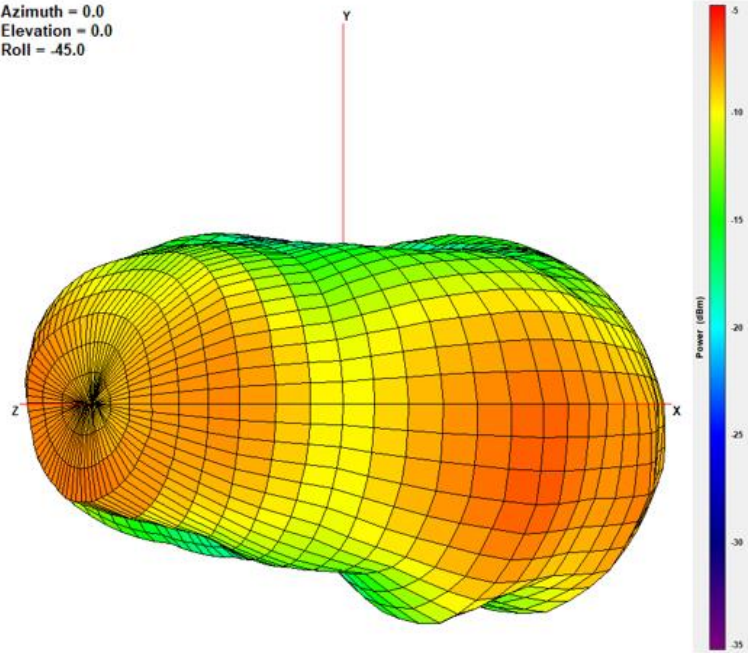

XY Plane

XZ Plane

YZ Plane

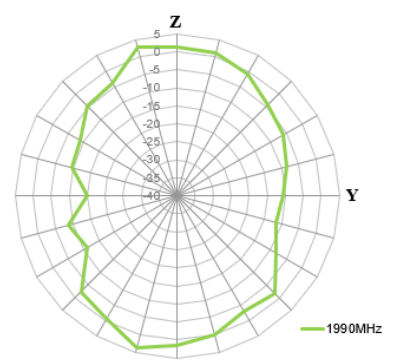
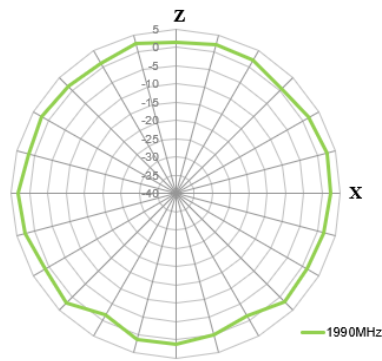
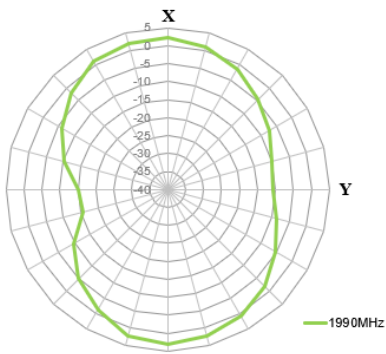



2595MHz

Azimuth = 0.0  
Elevation = 0.0  
Roll = -45.0

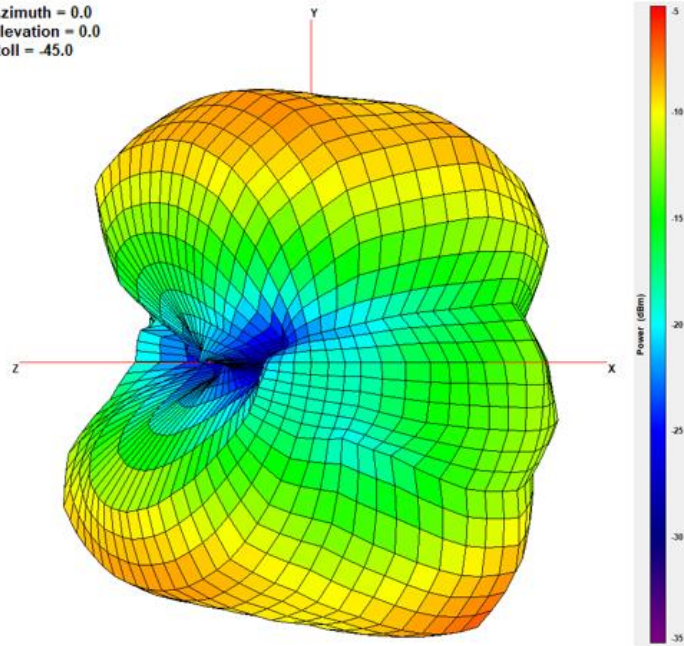

XY Plane

XZ Plane

YZ Plane

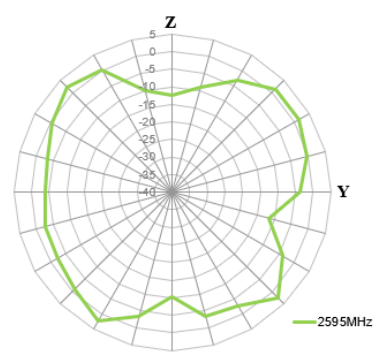
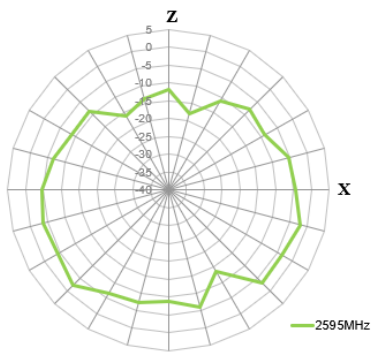
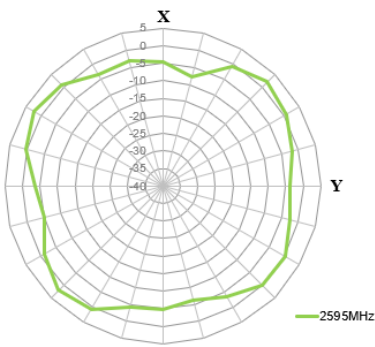

# 3550MHz

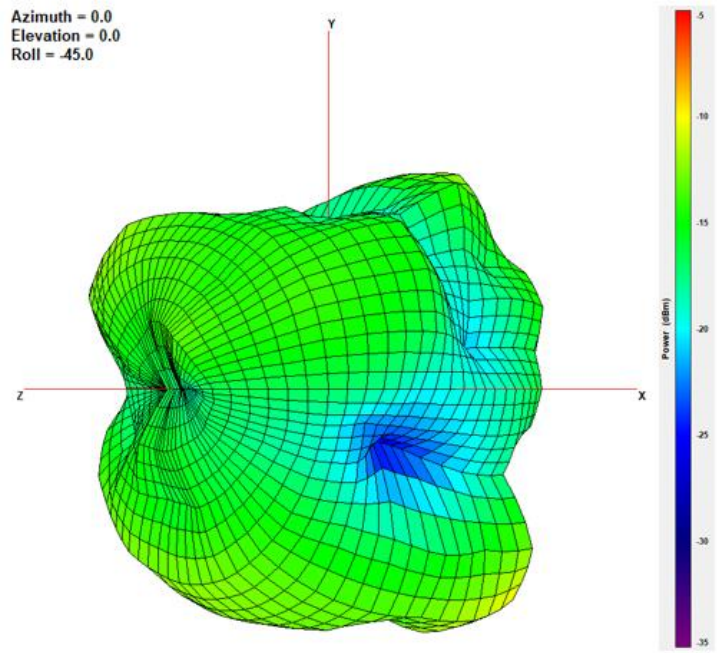

XY Plane

XZ Plane

YZ Plane

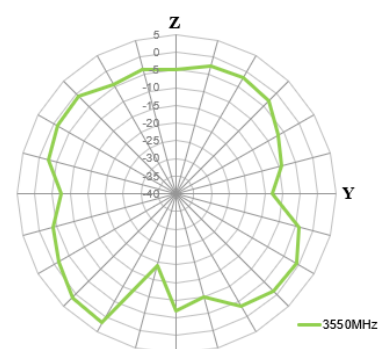
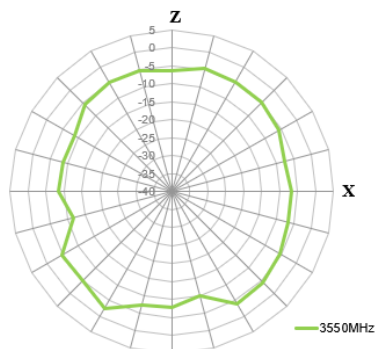
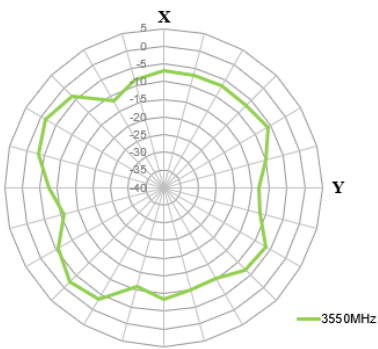

5530MHz

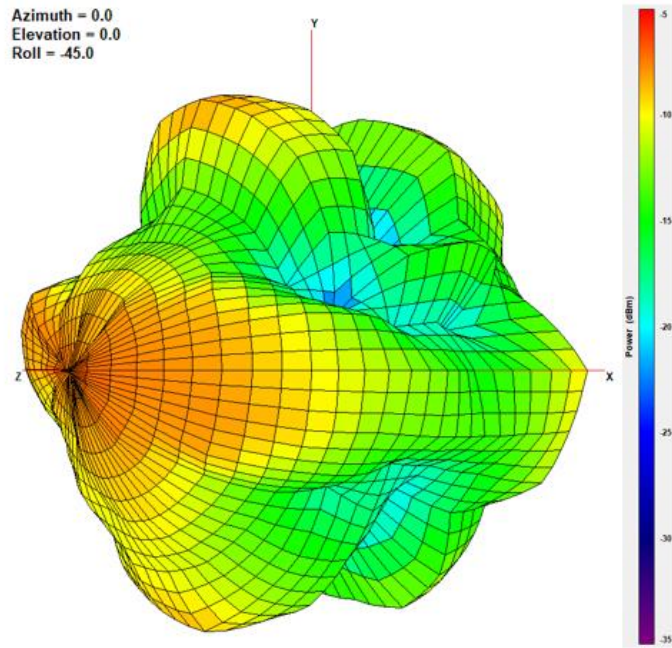

XY Plane

XZ Plane

YZ Plane

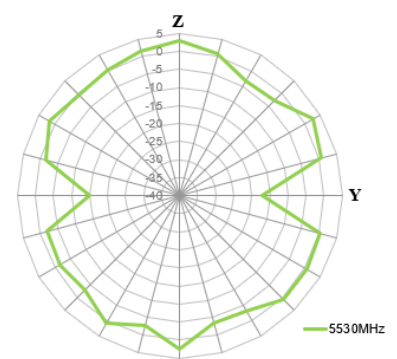
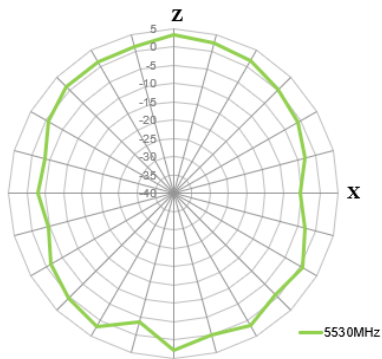
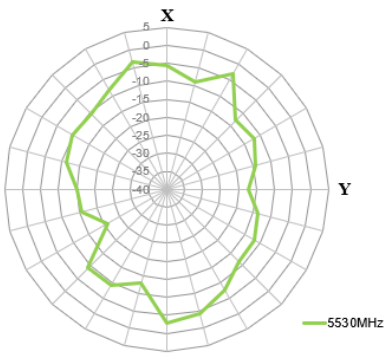

### 4.3 Test Setup – Straight in Freespace

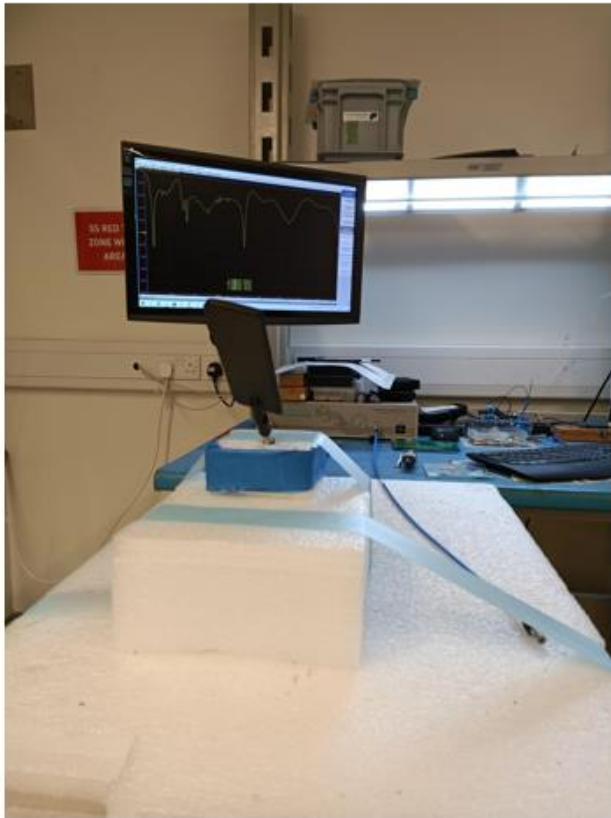

VNA Setup - Straight in Free space

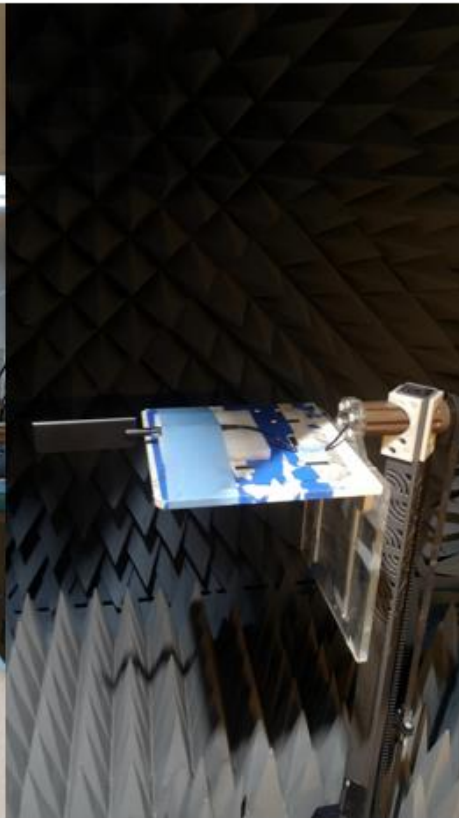

Chamber Setup - Straight in Free space

4.4 650MHz Straight\_In\_Freespace 2D & 3D Radiation Patterns

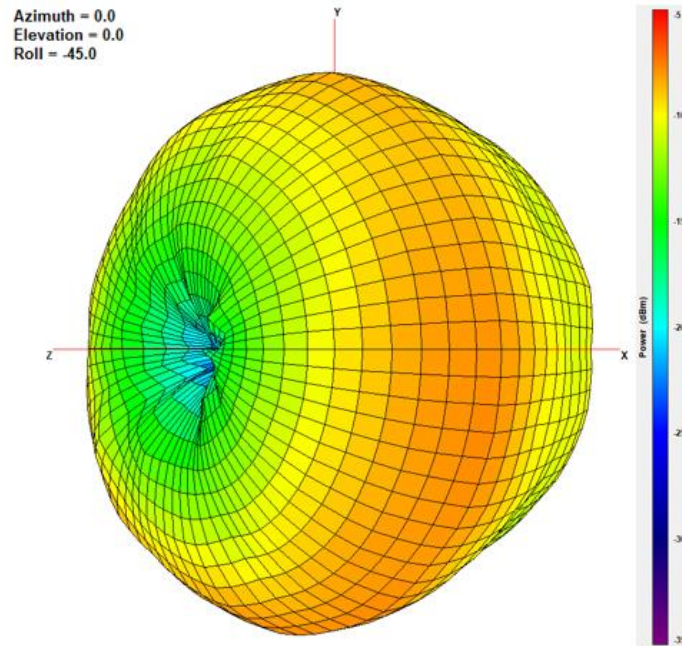

XY Plane

XZ Plane

YZ Plane

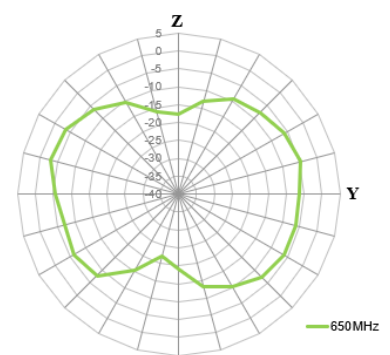
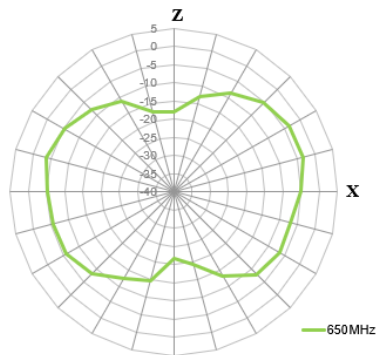
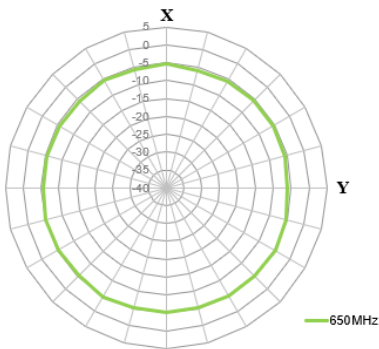

# 750MHz

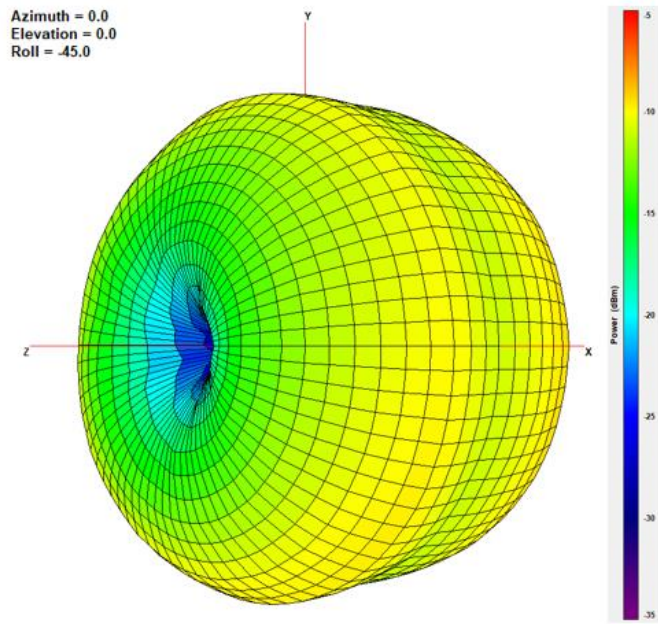

XY Plane

XZ Plane

YZ Plane

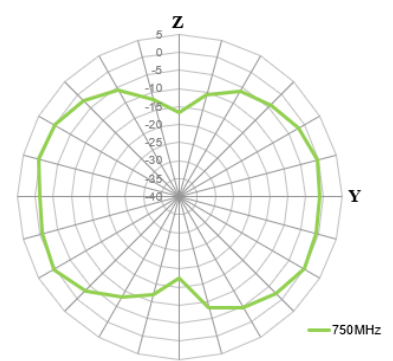
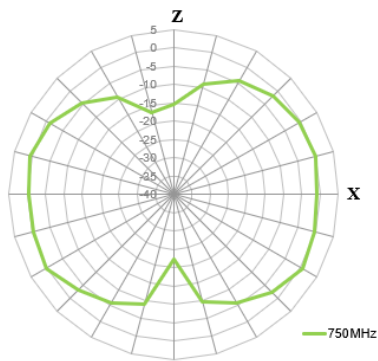
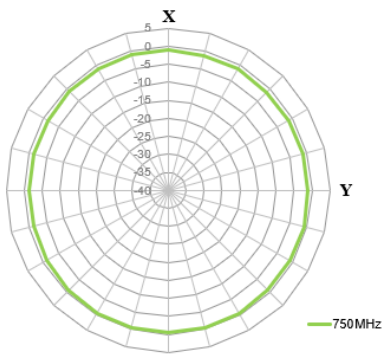

# 890MHz

Azimuth = 0.0  
Elevation = 0.0  
Roll = -45.0

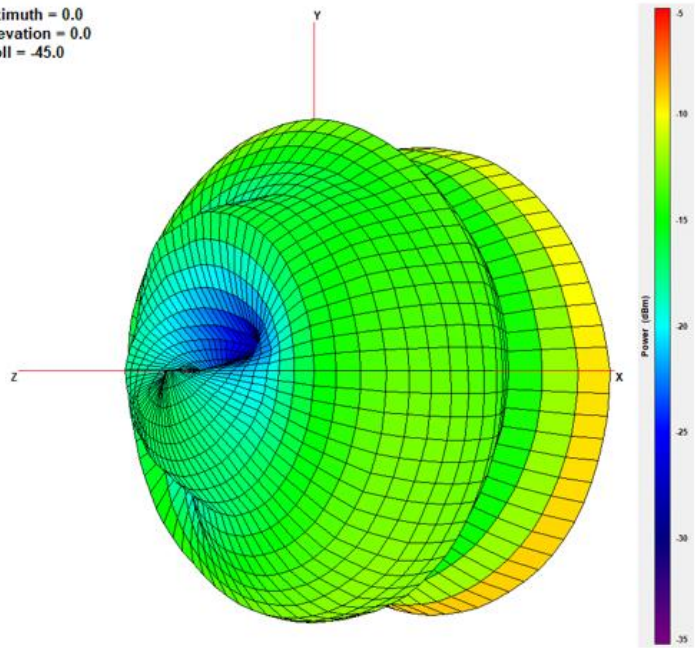

XY Plane

XZ Plane

YZ Plane

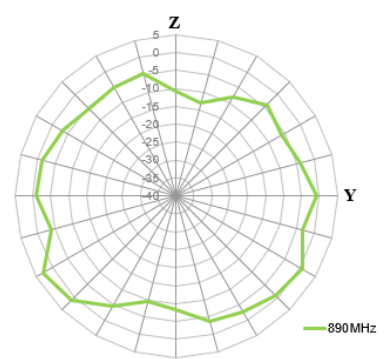
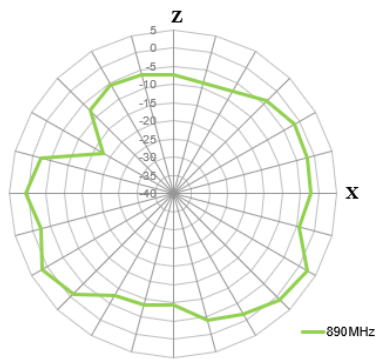
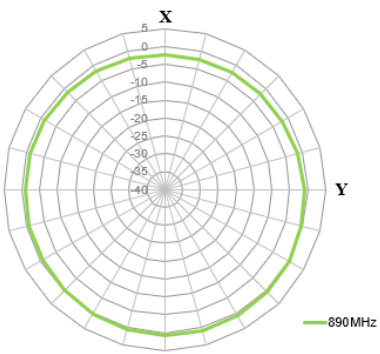

# 1470MHz

Azimuth = 0.0  
Elevation = 0.0  
Roll = -45.0

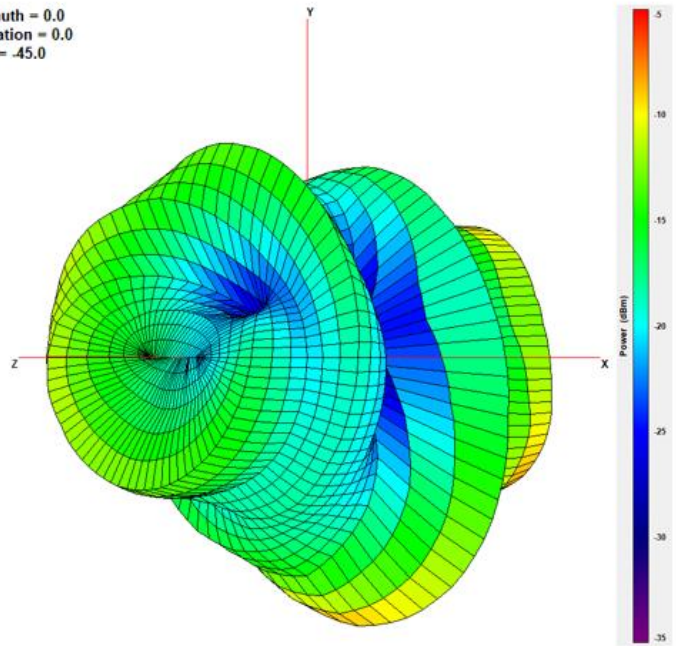

XY Plane

XZ Plane

YZ Plane

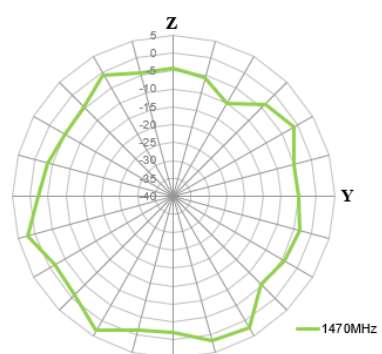
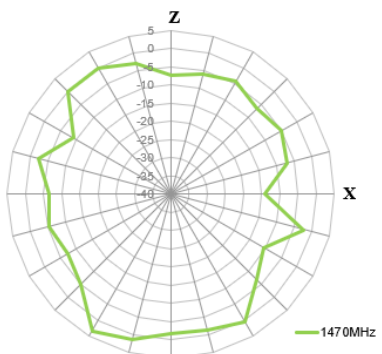
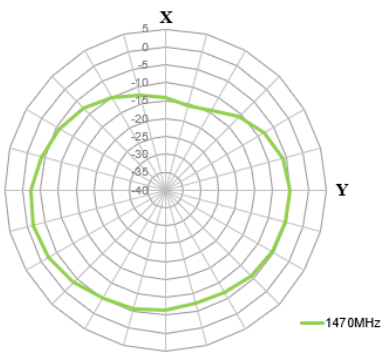



# 1805MHz

Azimuth = 0.0  
Elevation = 0.0  
Roll = -45.0

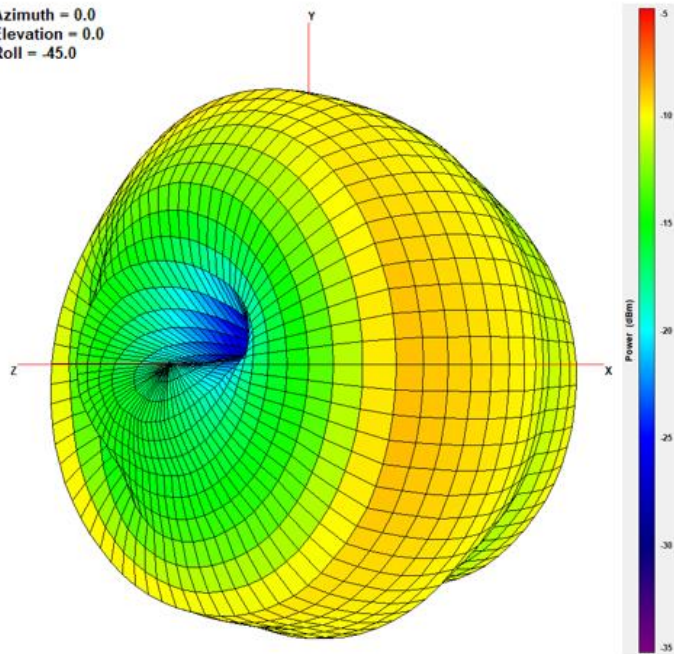

XY Plane

XZ Plane

YZ Plane

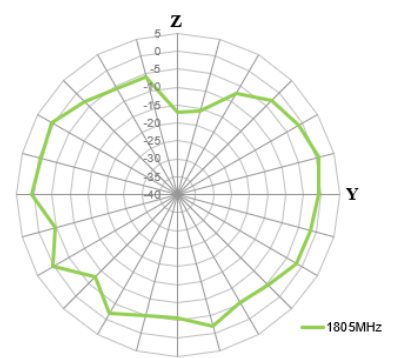
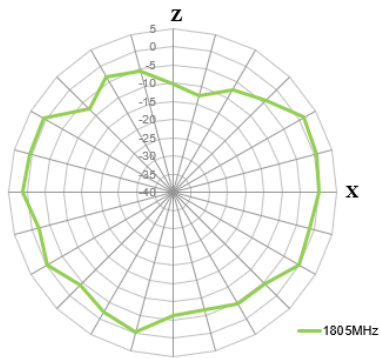
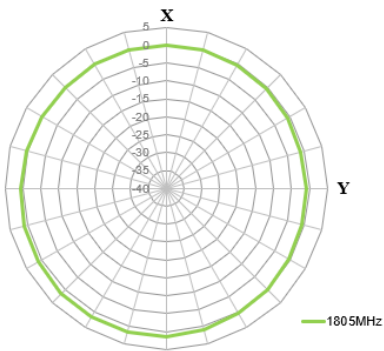

# 1920MHz

Azimuth = 0.0  
Elevation = 0.0  
Roll = -45.0

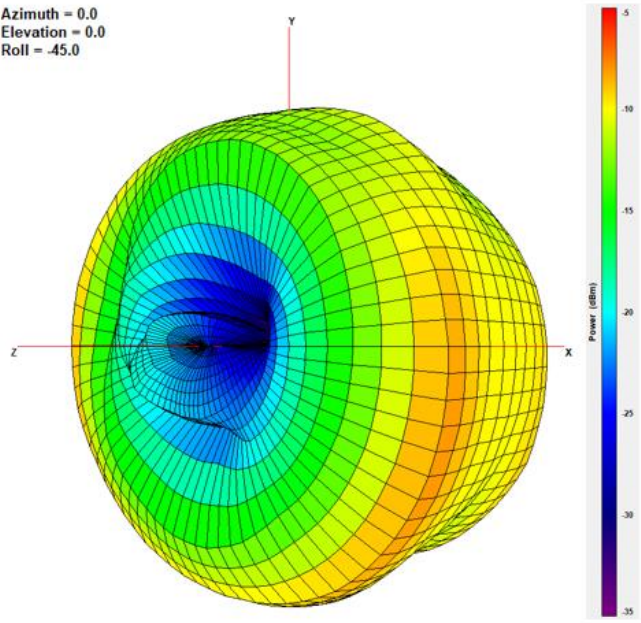

XY Plane

XZ Plane

YZ Plane

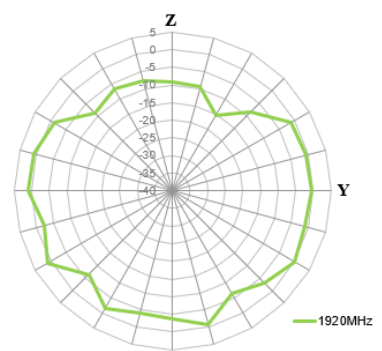
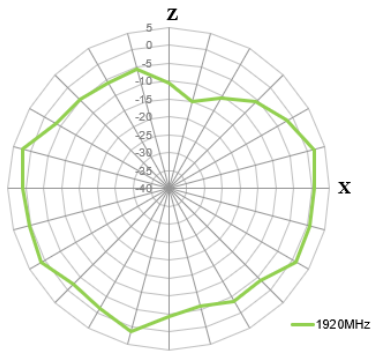
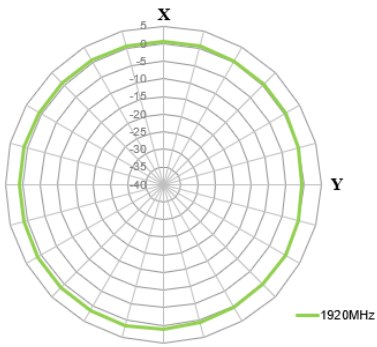

# 1990MHz

Azimuth = 0.0  
Elevation = 0.0  
Roll = -45.0

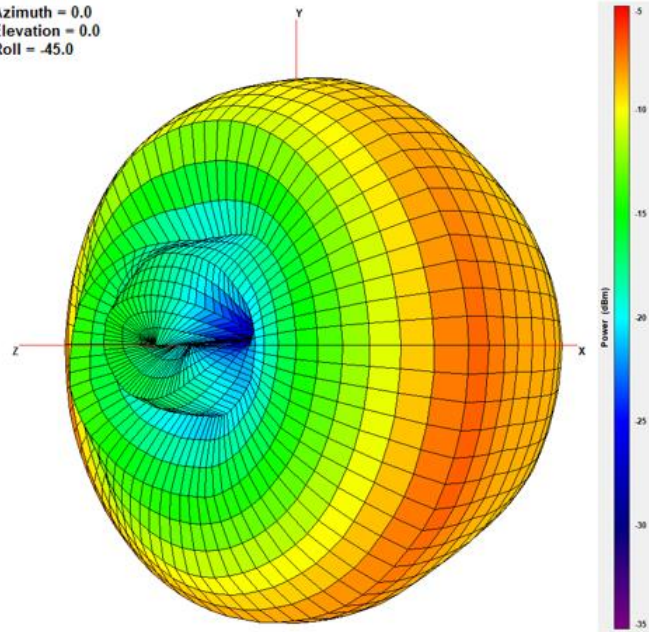

XY Plane

XZ Plane

YZ Plane

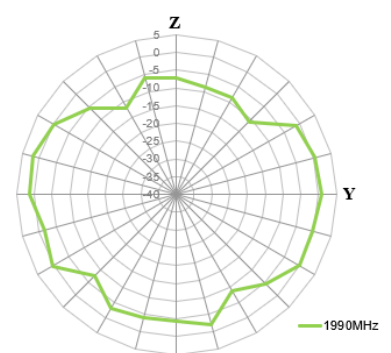
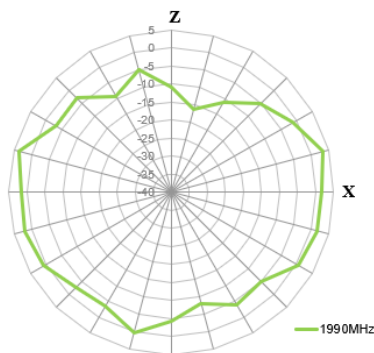
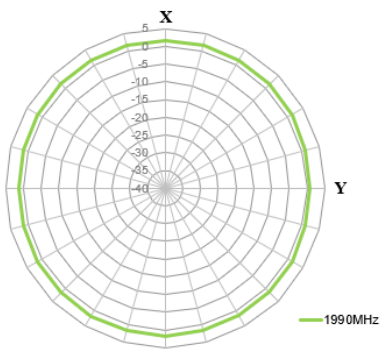

# 2595MHz

Azimuth = 0.0  
Elevation = 0.0  
Roll = -45.0

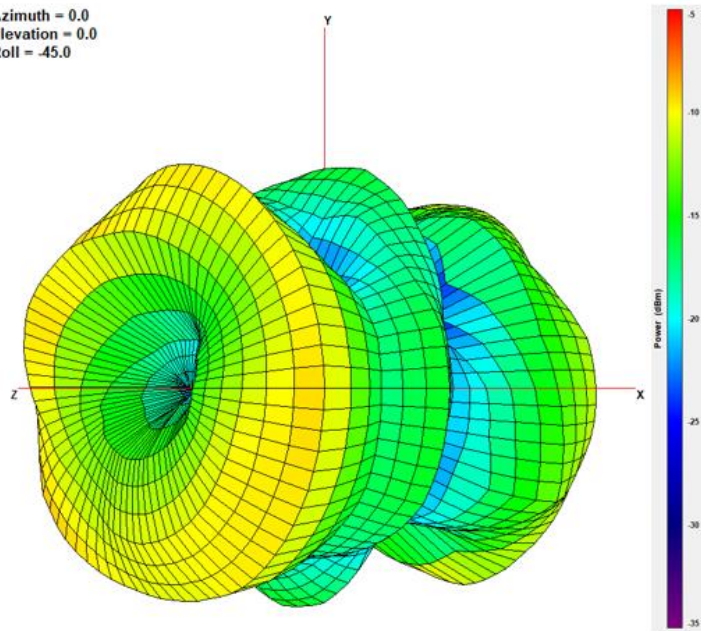

XY Plane

XZ Plane

YZ Plane

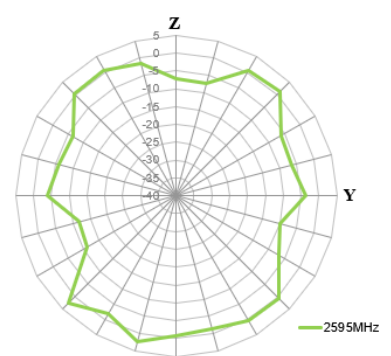
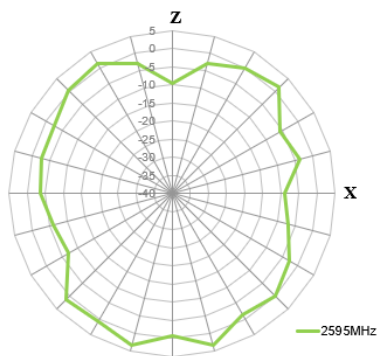
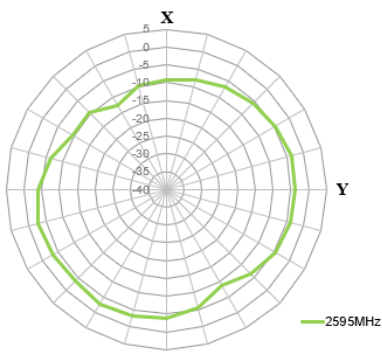

# 3550MHz

Azimuth = 0.0  
Elevation = 0.0  
Roll = -45.0

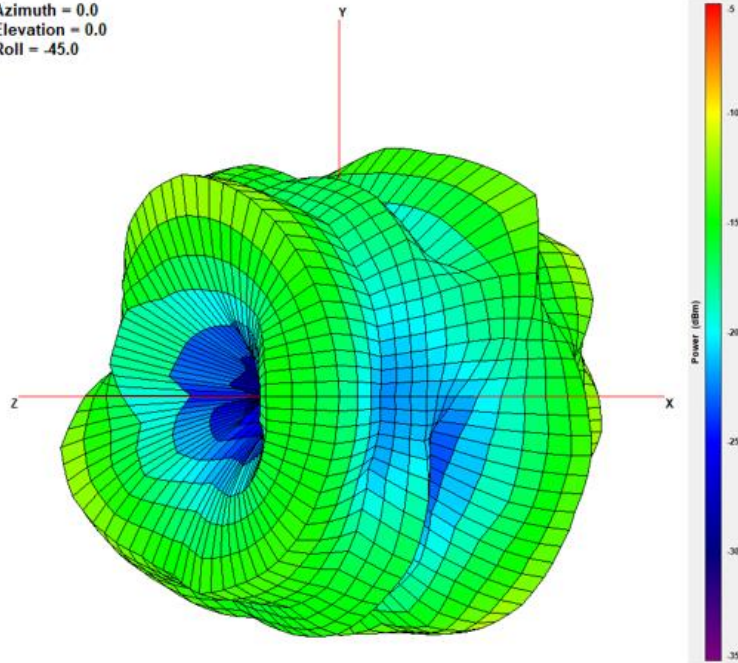

XY Plane

XZ Plane

YZ Plane

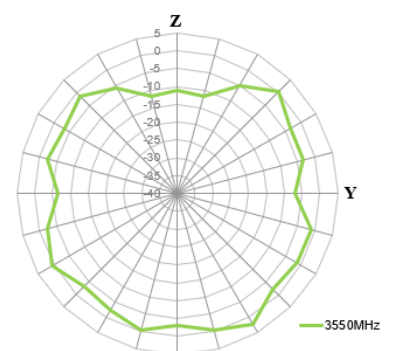
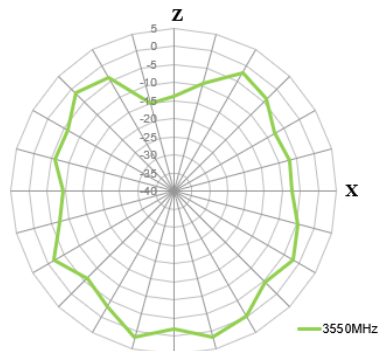
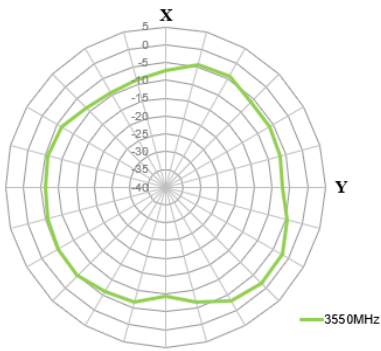

# 5530MHz

Azimuth = 0.0  
Elevation = 0.0  
Roll = -45.0

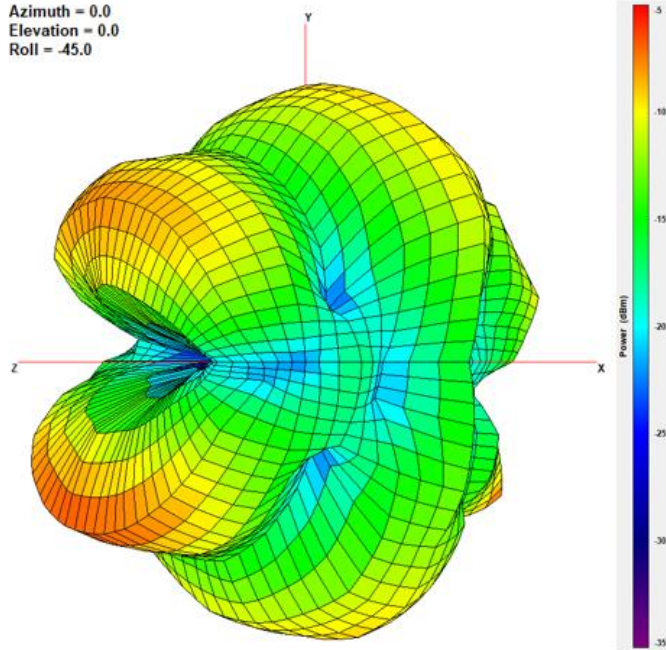

XY Plane

XZ Plane

YZ Plane

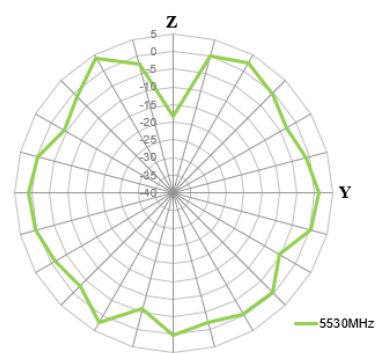
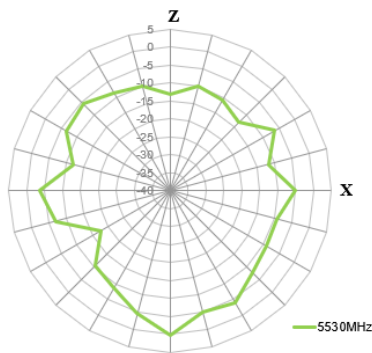
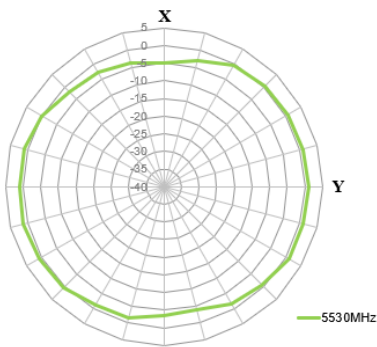

#### 4.5 Test Setup – Bent On Edge 30X30cm Ground plane

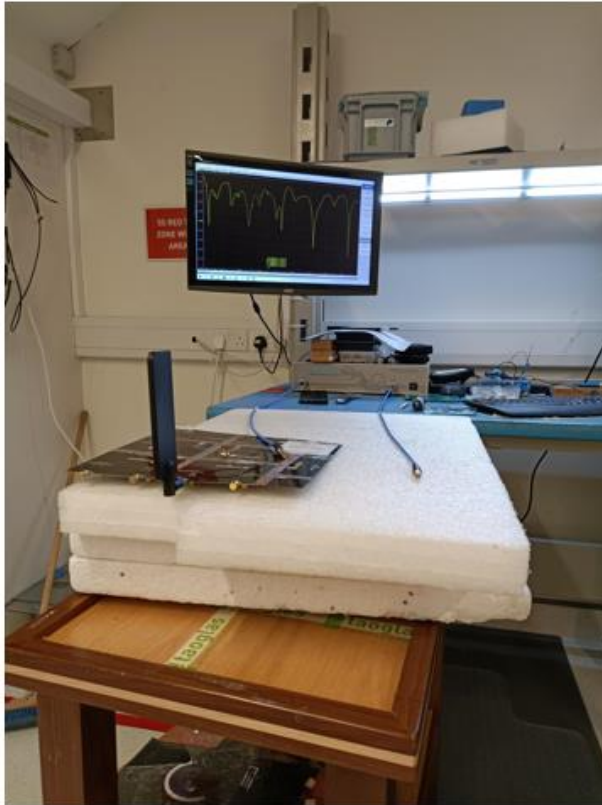

VNA Setup - Bent on Edge of 30X30cm Ground plane

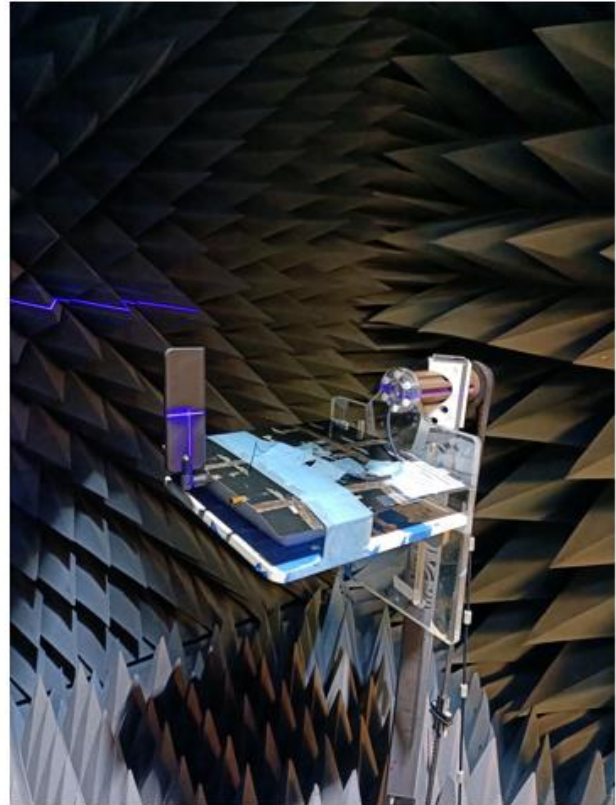

Chamber Setup – Bent on Edge of 30X30cm Ground plane

4.6 650MHz Bent On Edge 30X30cm Ground plane 2D & 3D Radiation Patterns

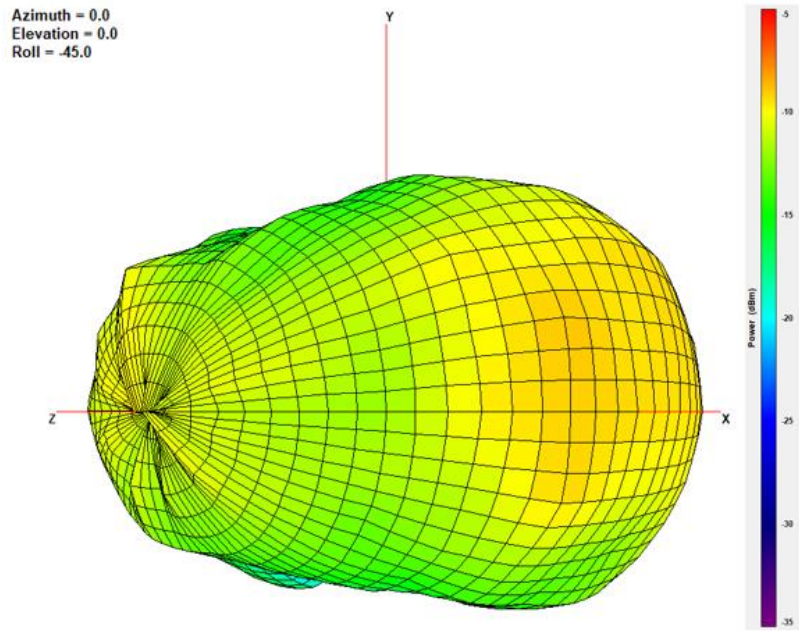

XY Plane

XZ Plane

YZ Plane

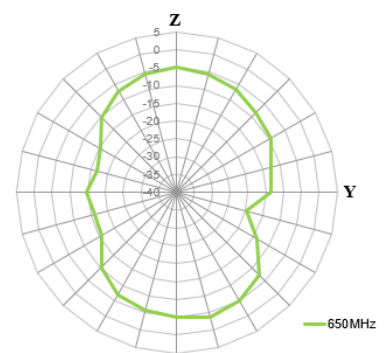
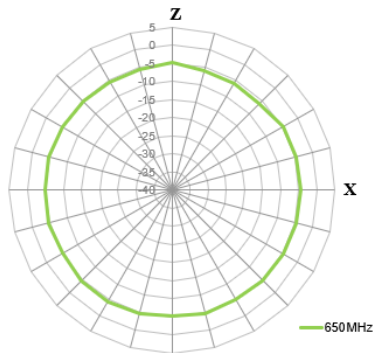
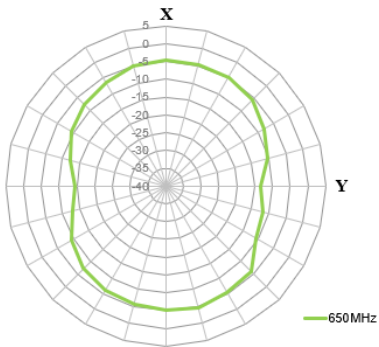



# 750MHz

Azimuth = 0.0  
 Elevation = 0.0  
 Roll = -45.0

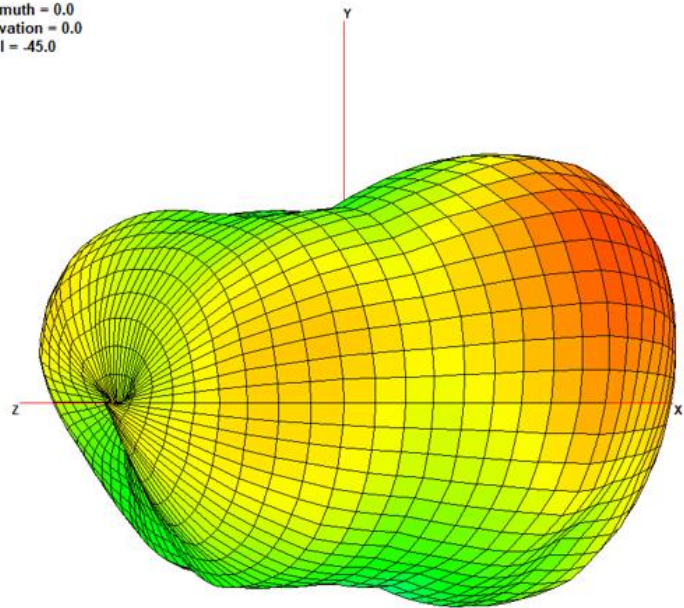

XY Plane

XZ Plane

YZ Plane

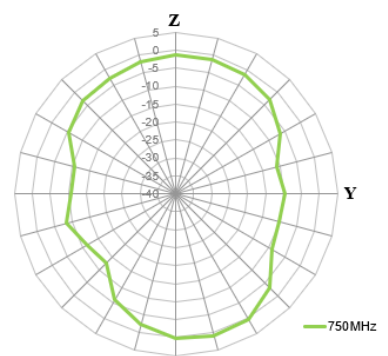
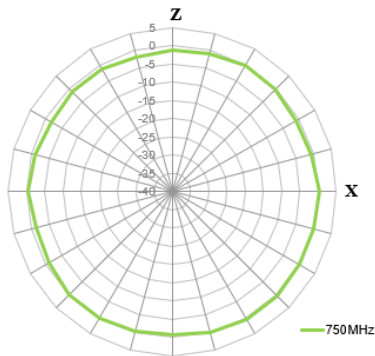
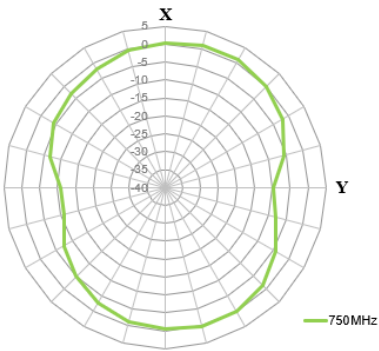

# 890MHz

Azimuth = 0.0  
 Elevation = 0.0  
 Roll = -45.0

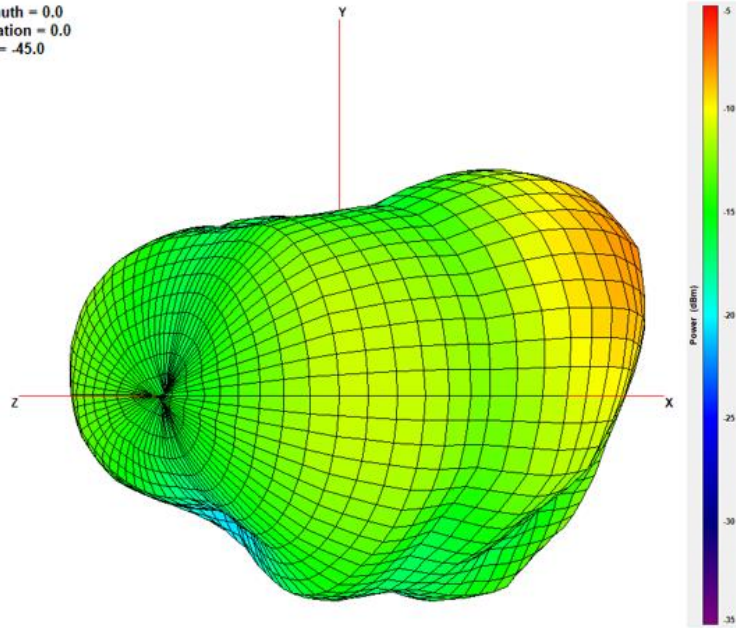

XY Plane

XZ Plane

YZ Plane

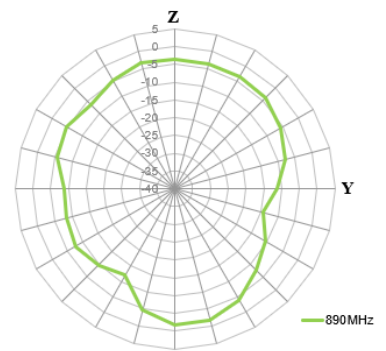
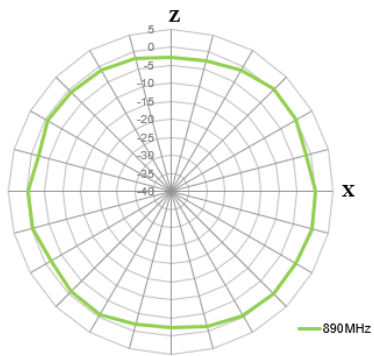
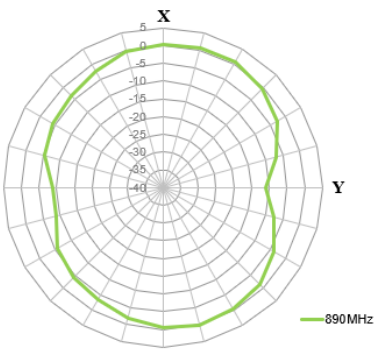

# 1470MHz

Azimuth = 0.0  
 Elevation = 0.0  
 Roll = -45.0

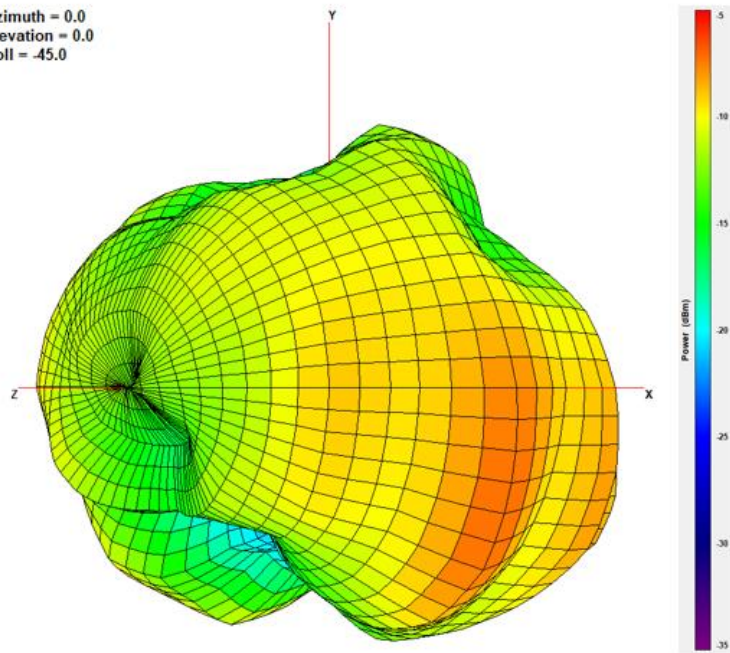

XY Plane

XZ Plane

YZ Plane

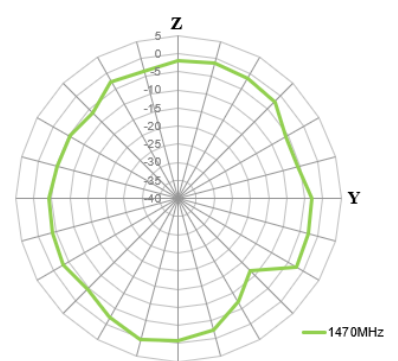
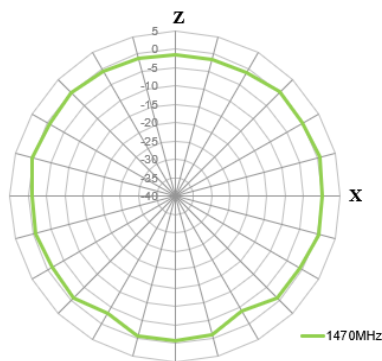
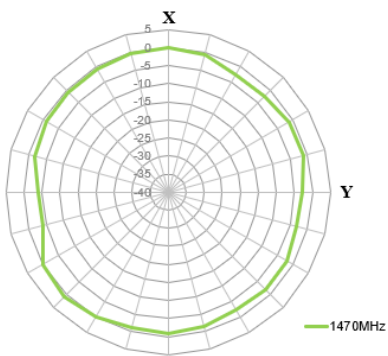

1805MHz

Azimuth = 0.0  
Elevation = 0.0  
Roll = -45.0

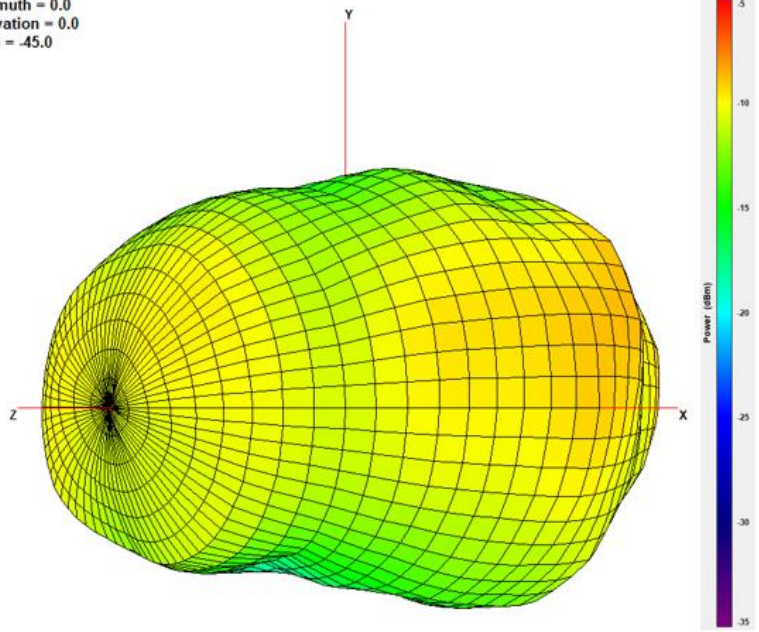

XY Plane

XZ Plane

YZ Plane

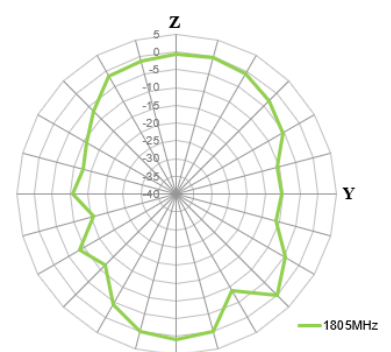
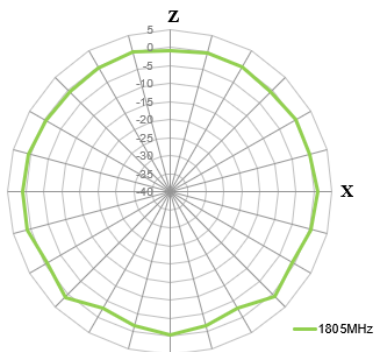
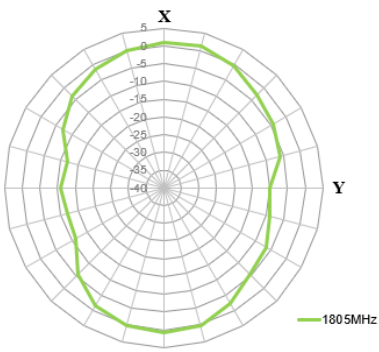

1920MHz

Azimuth = 0.0  
Elevation = 0.0  
Roll = -45.0

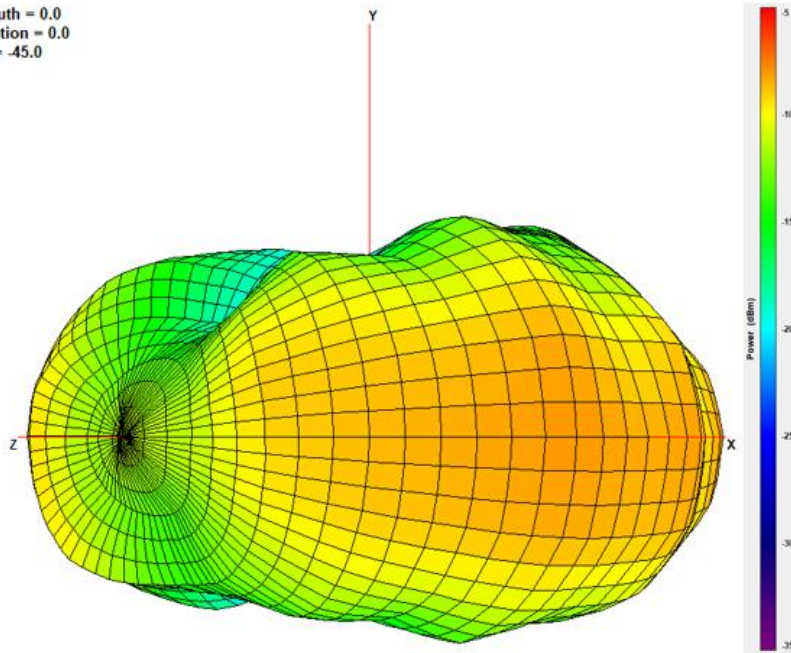

XY Plane

XZ Plane

YZ Plane

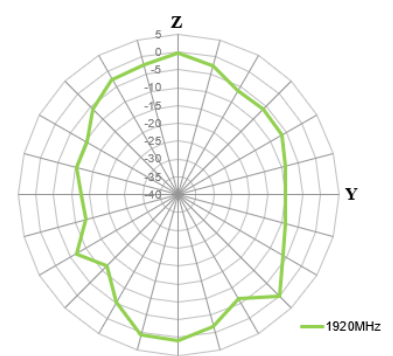
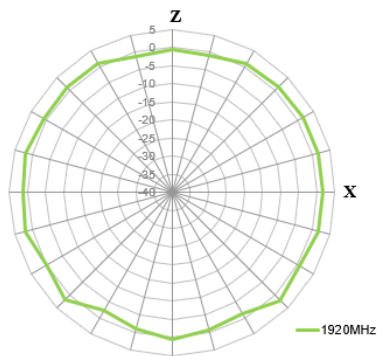
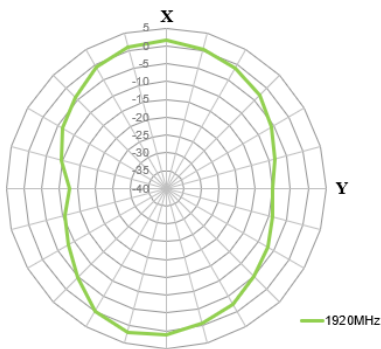

1990MHz

Azimuth = 0.0  
Elevation = 0.0  
Roll = -45.0

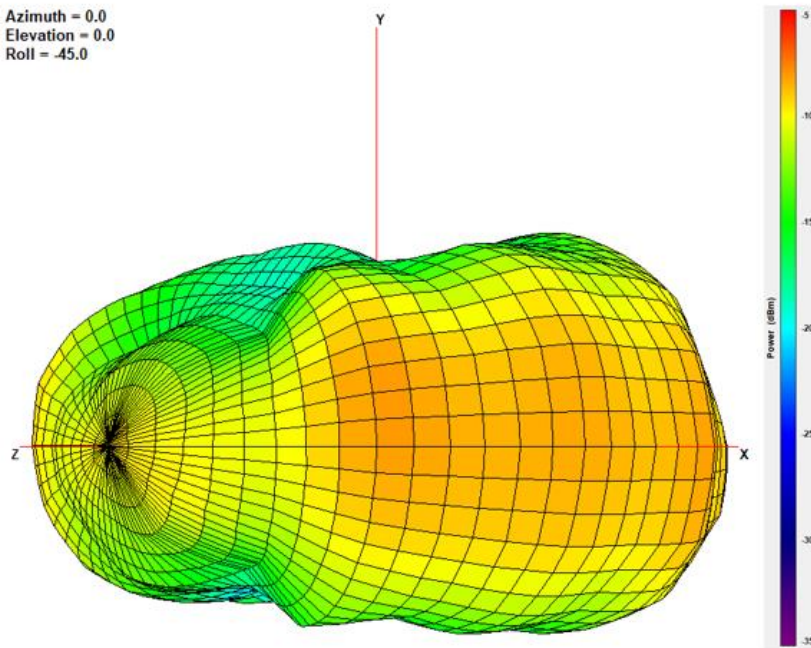

XY Plane

XZ Plane

YZ Plane

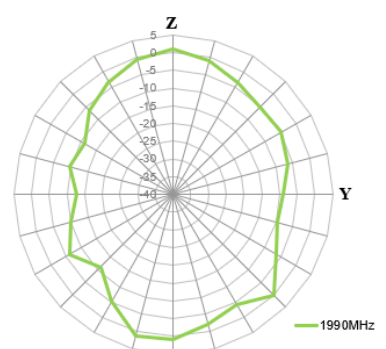
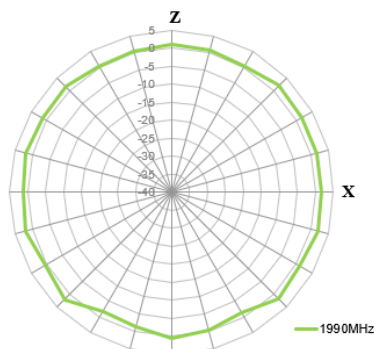
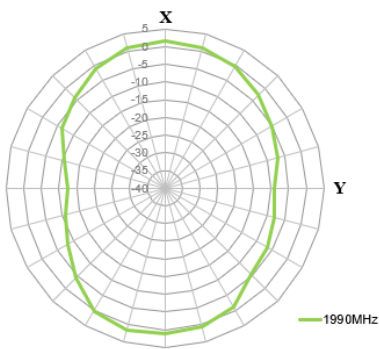

2595MHz

Azimuth = 0.0  
Elevation = 0.0  
Roll = -45.0

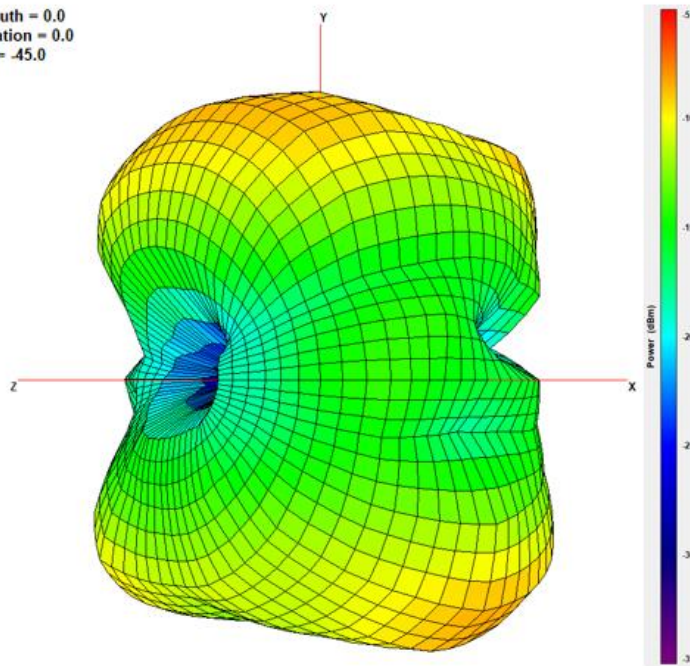

XY Plane

XZ Plane

YZ Plane

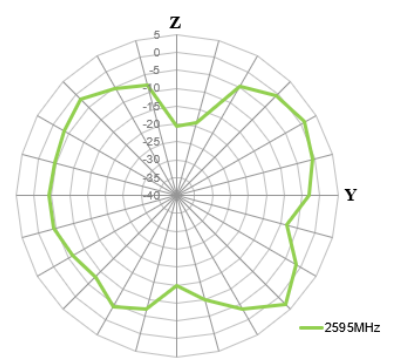
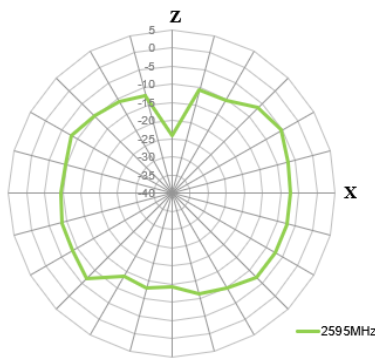
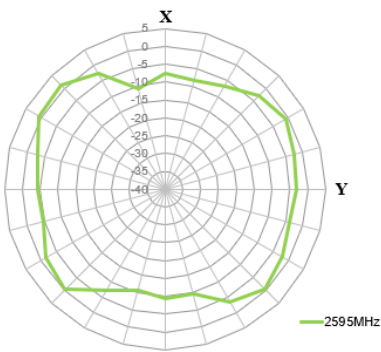

# 3550MHz

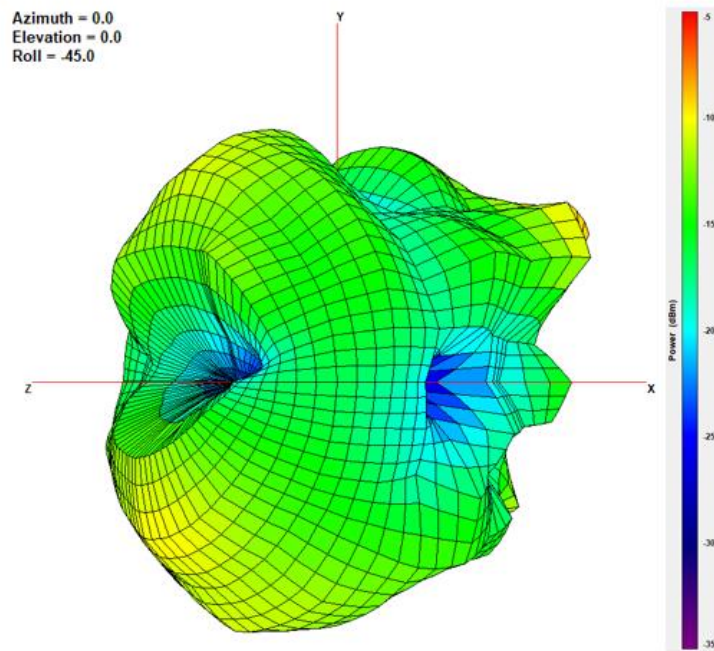

XY Plane

XZ Plane

YZ Plane

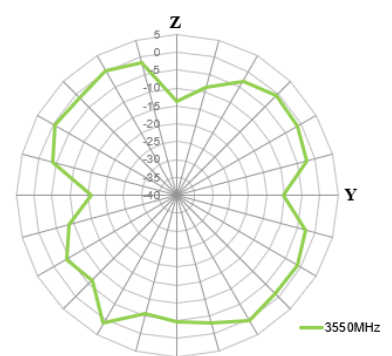
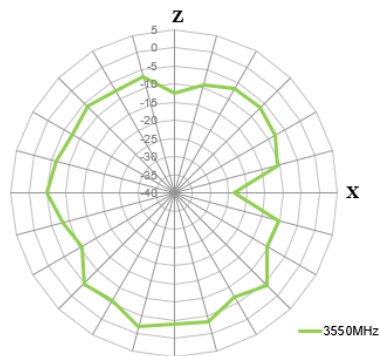
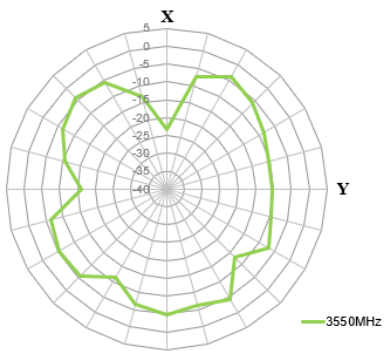



# 5530MHz

Azimuth = 0.0  
Elevation = 0.0  
Roll = -45.0

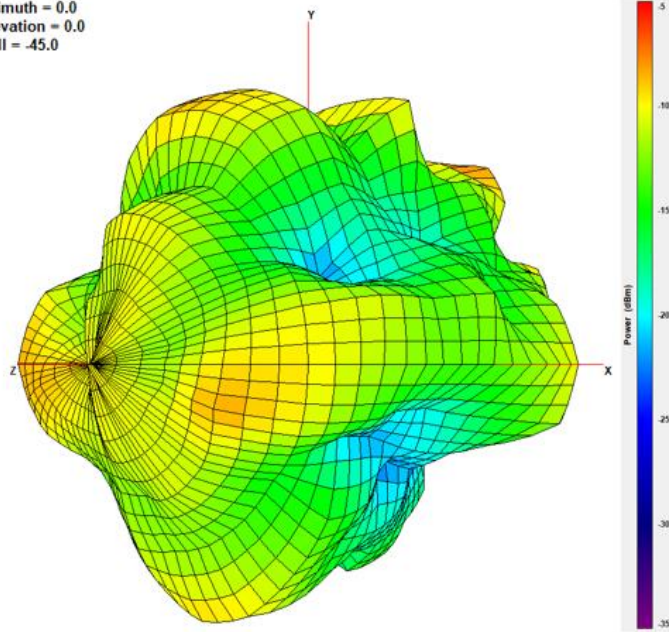

XY Plane

XZ Plane

YZ Plane

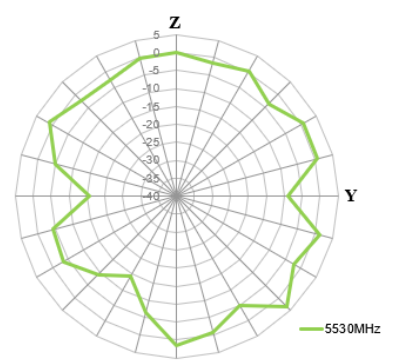
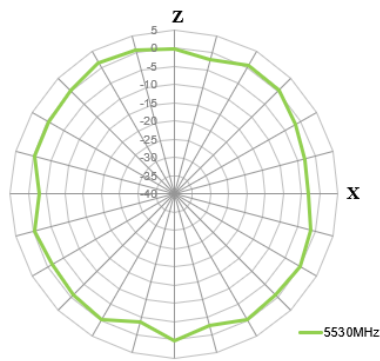
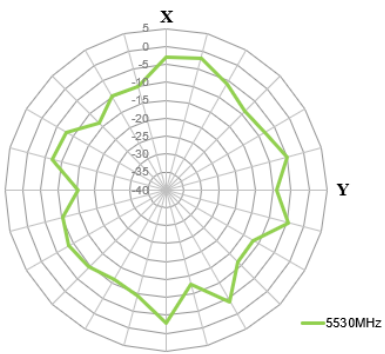

## 4.7 Test Setup – Straight On Edge 30X30cm Ground plane

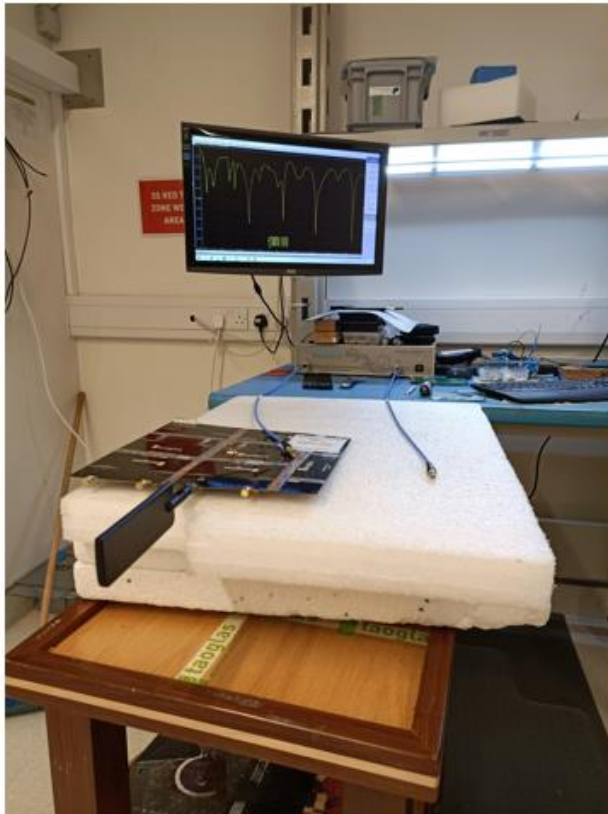

VNA Setup - Straight on Edge of 30X30cm Ground plane

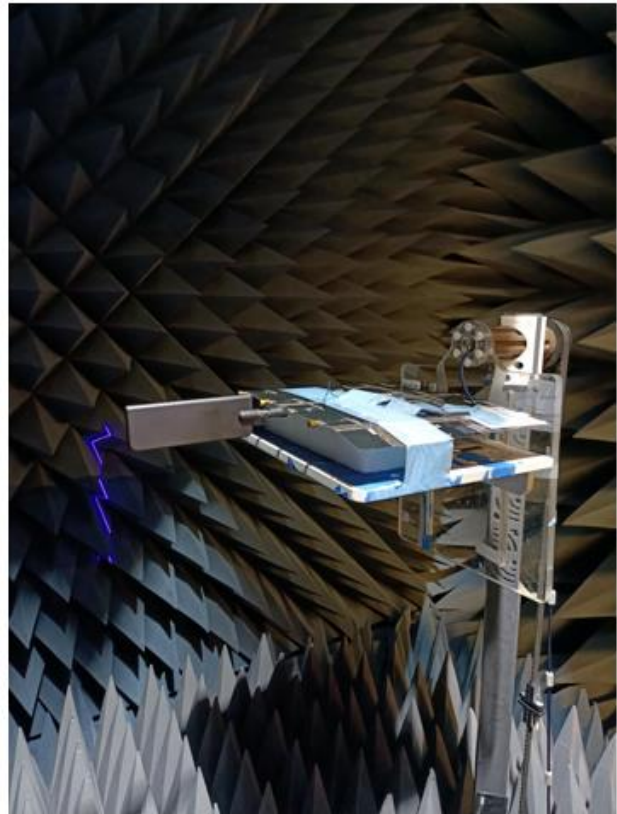

Chamber Setup - Straight on Edge of 30X30cm Ground plane

4.8 650MHz Straight On Edge 30X30cm Ground plane 2D & 3D Radiation Patterns

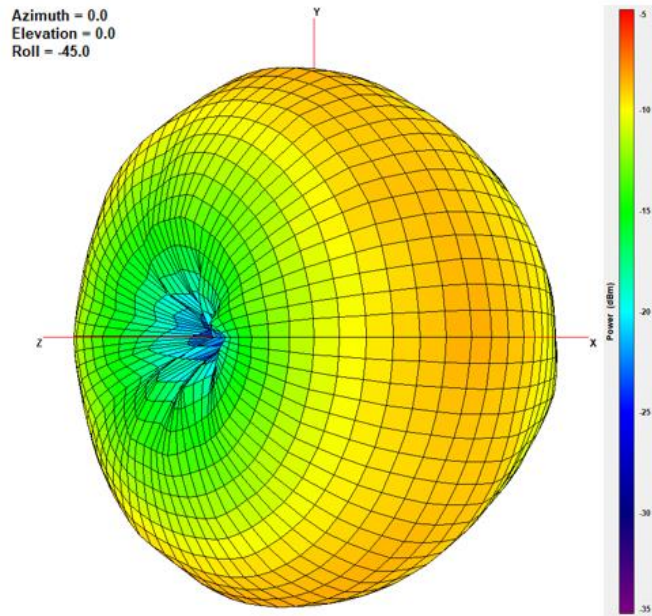

XY Plane

XZ Plane

YZ Plane

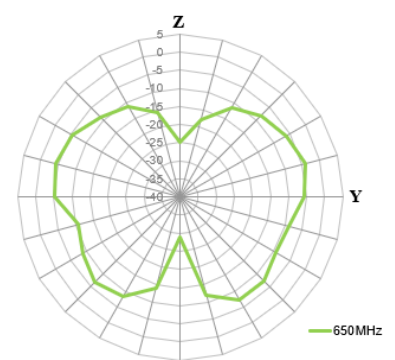
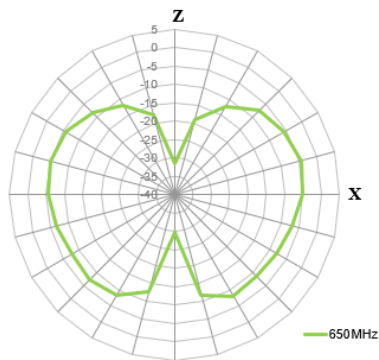
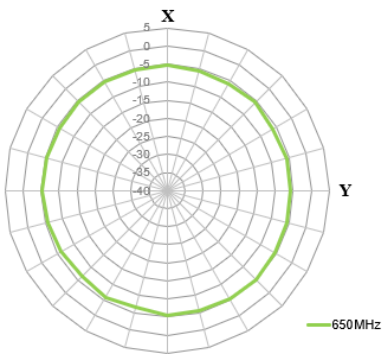

# 750MHz

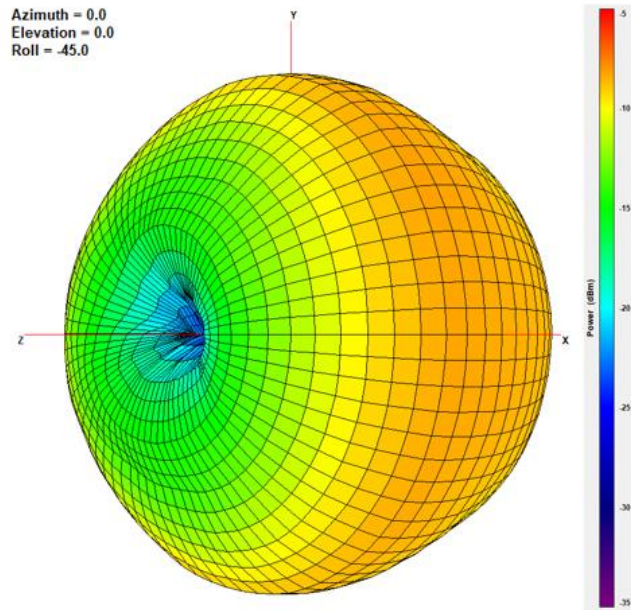

XY Plane

XZ Plane

YZ Plane

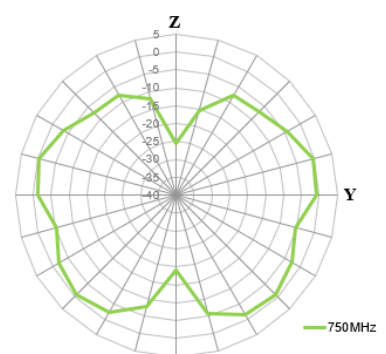
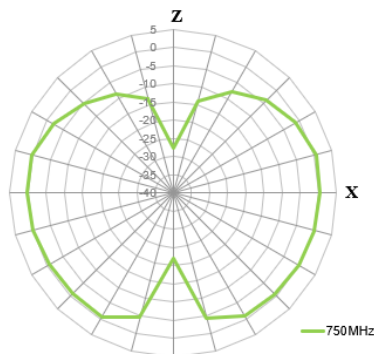
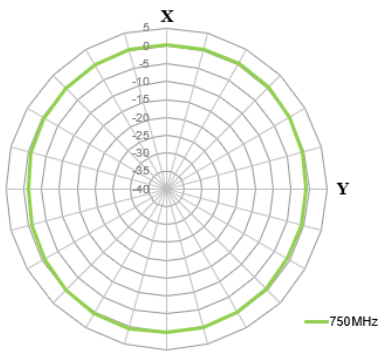

# 890MHz

Azimuth = 0.0  
Elevation = 0.0  
Roll = -45.0

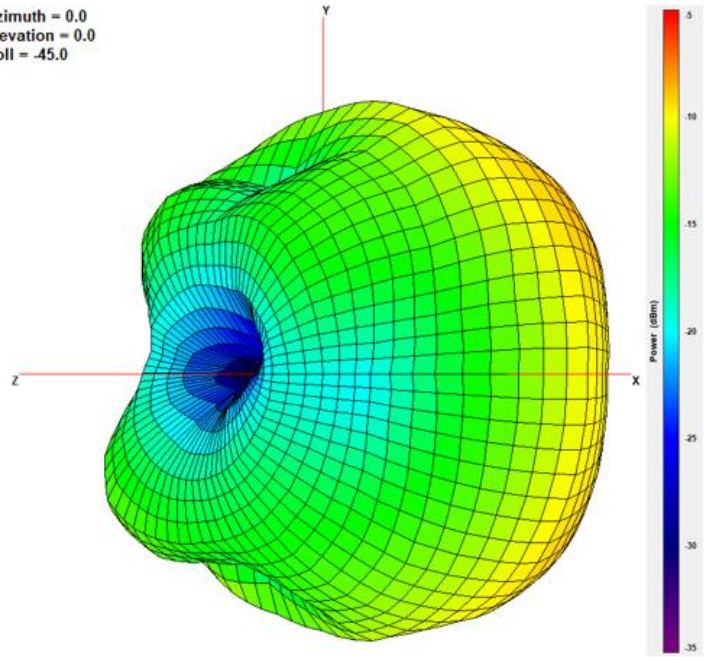

XY Plane

XZ Plane

YZ Plane

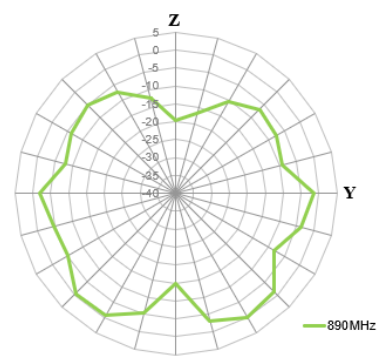
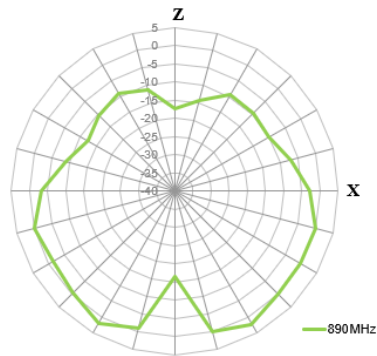
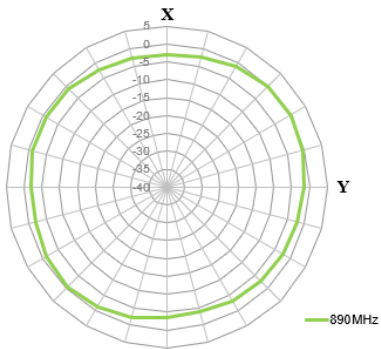

# 1470MHz

Azimuth = 0.0  
Elevation = 0.0  
Roll = -45.0

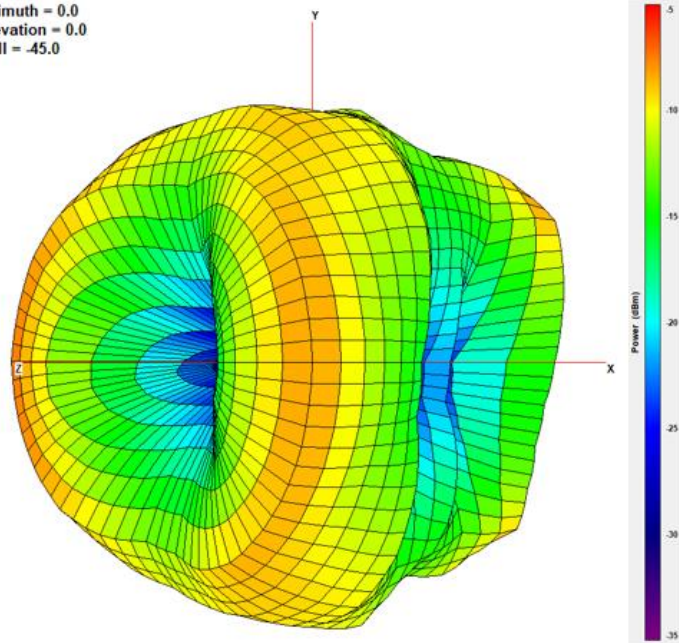

XY Plane

XZ Plane

YZ Plane

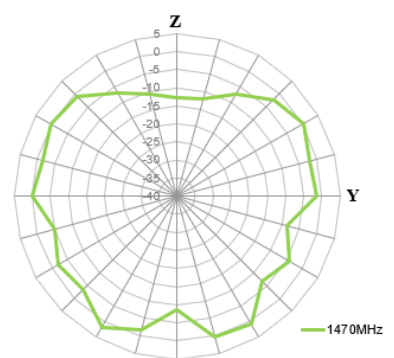
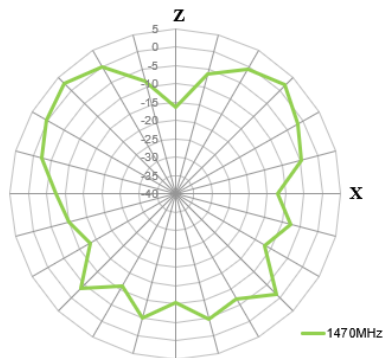
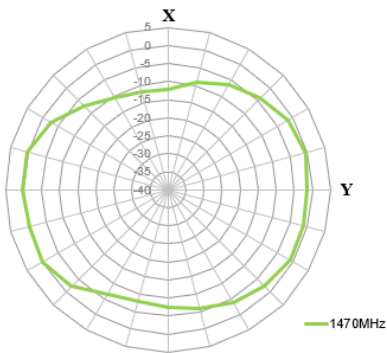

1805MHz

Azimuth = 0.0  
Elevation = 0.0  
Roll = -45.0

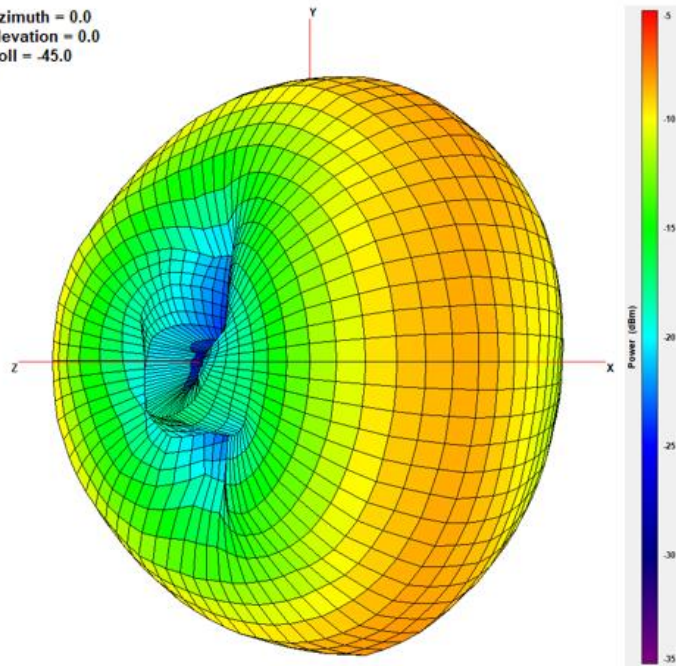

XY Plane

XZ Plane

YZ Plane

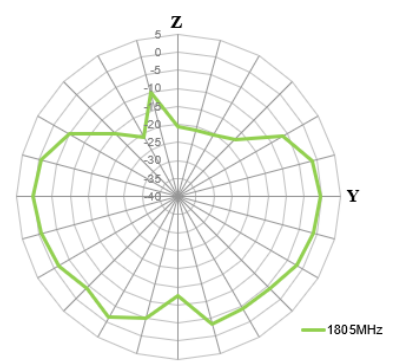
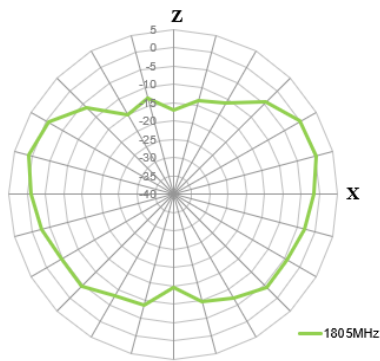
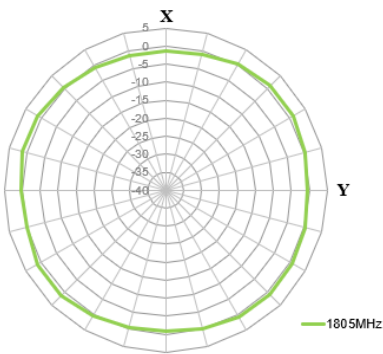

# 1920MHz

Azimuth = 0.0  
 Elevation = 0.0  
 Roll = -45.0

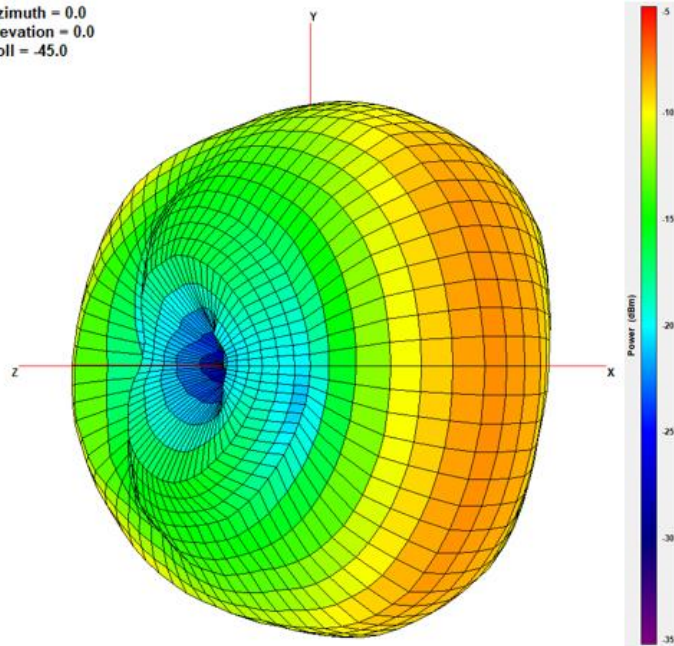

XY Plane

XZ Plane

YZ Plane

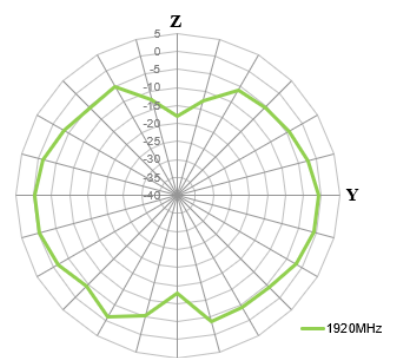
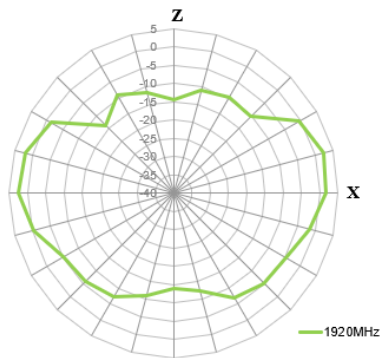
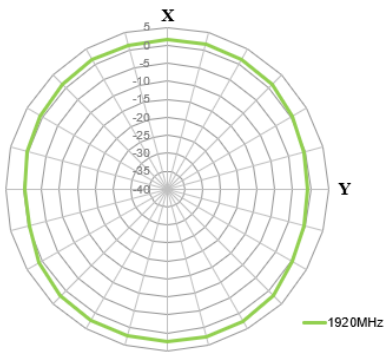



# 1990MHz

Azimuth = 0.0  
Elevation = 0.0  
Roll = -45.0

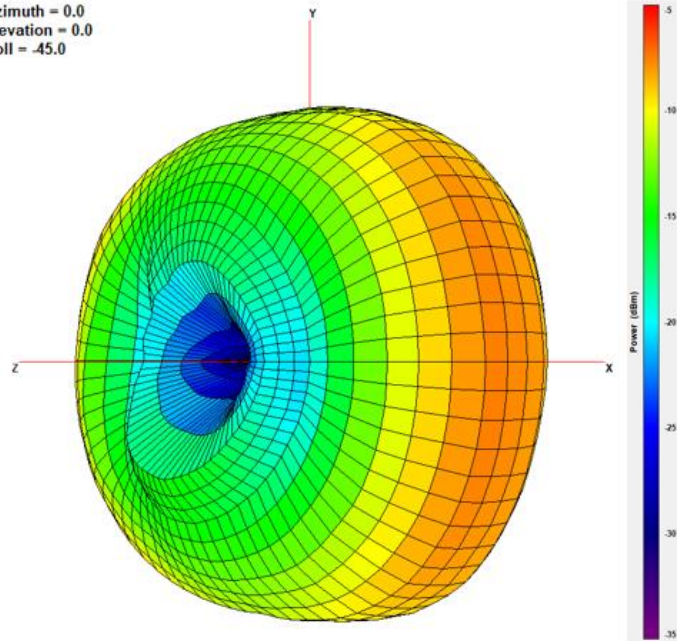

XY Plane

XZ Plane

YZ Plane

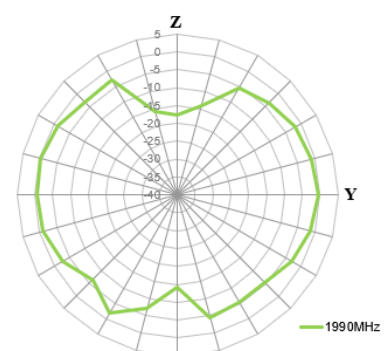
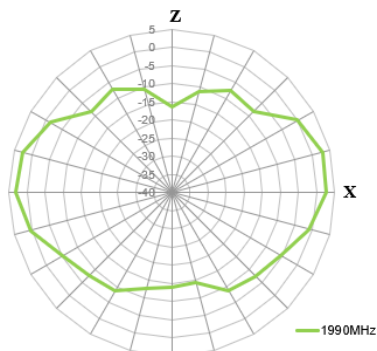
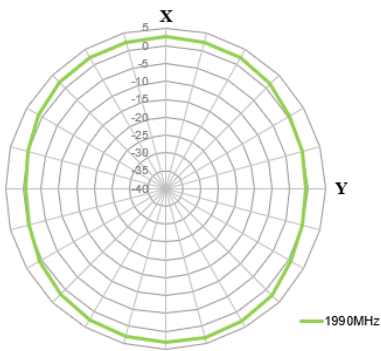

# 2595MHz

Azimuth = 0.0  
 Elevation = 0.0  
 Roll = -45.0

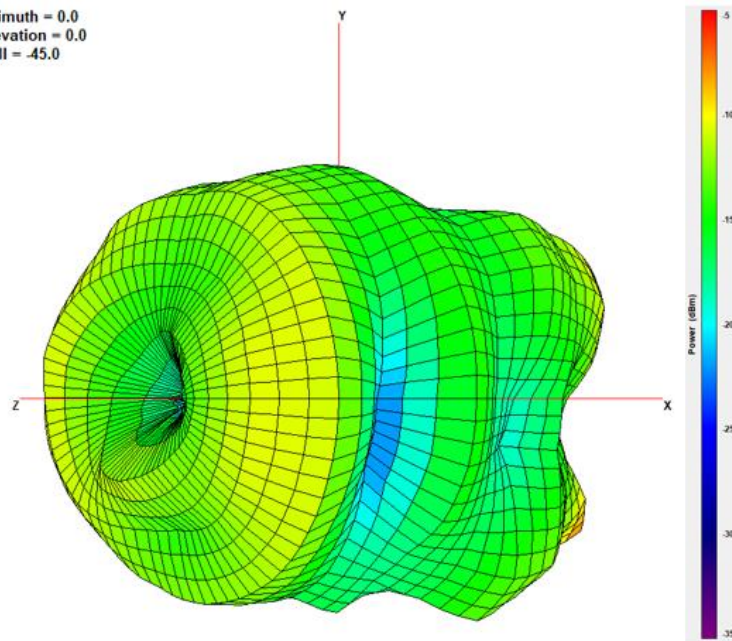

XY Plane

XZ Plane

YZ Plane

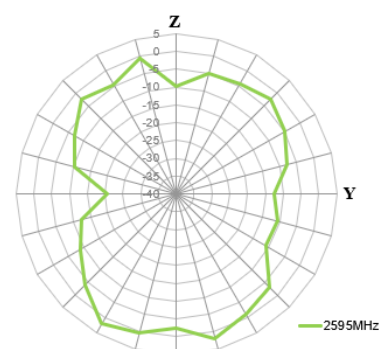
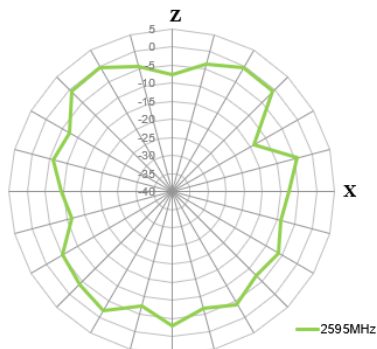
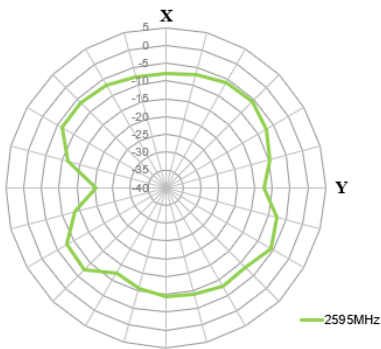

# 3550MHz

Azimuth = 0.0  
Elevation = 0.0  
Roll = -45.0

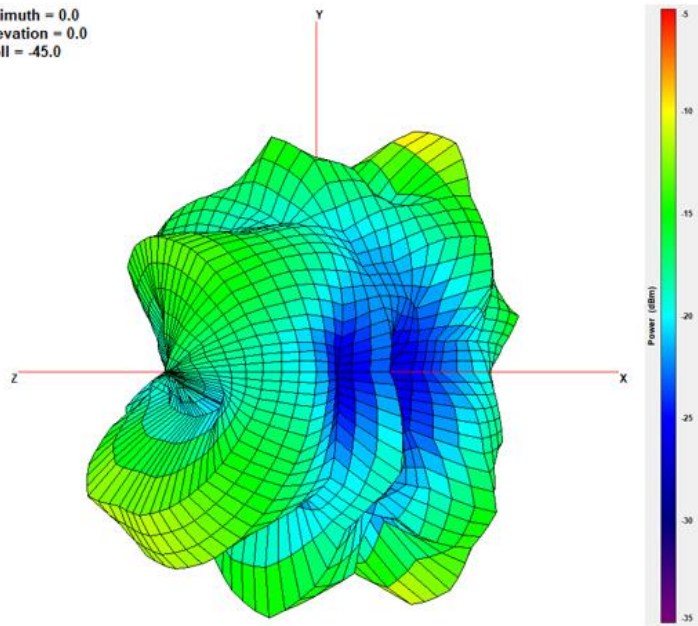

XY Plane

XZ Plane

YZ Plane

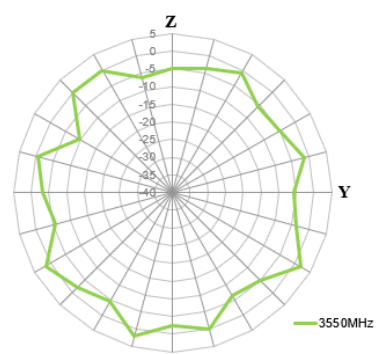
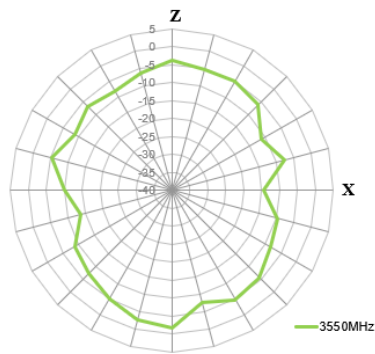
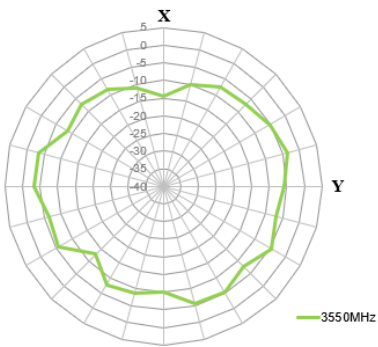

# 5530MHz

Azimuth = 0.0  
Elevation = 0.0  
Roll = -45.0

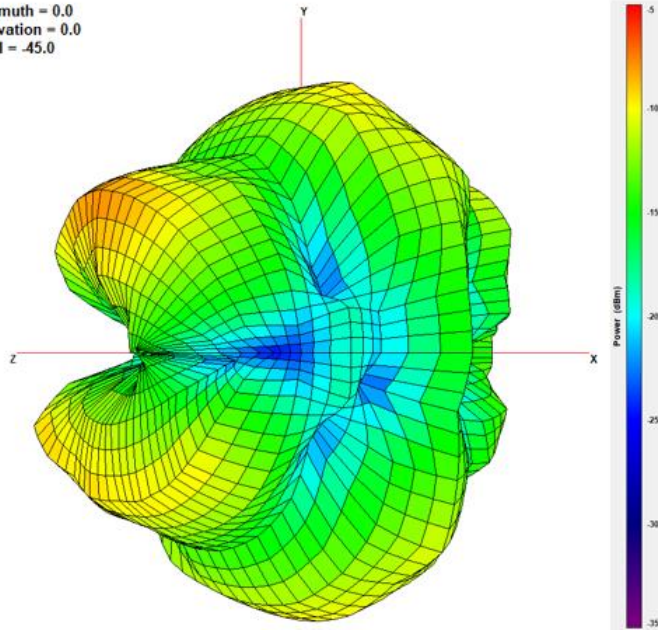

XY Plane

XZ Plane

YZ Plane

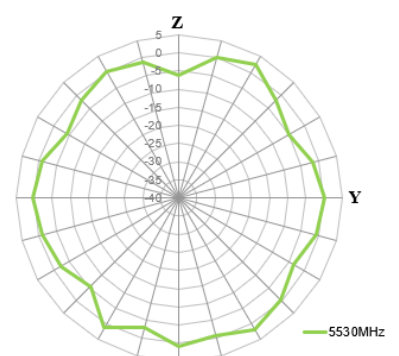
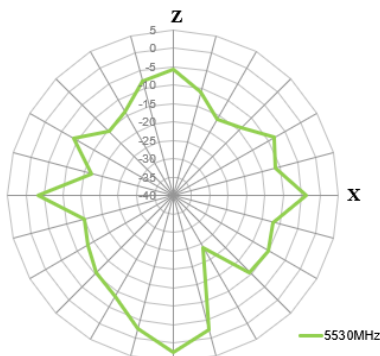
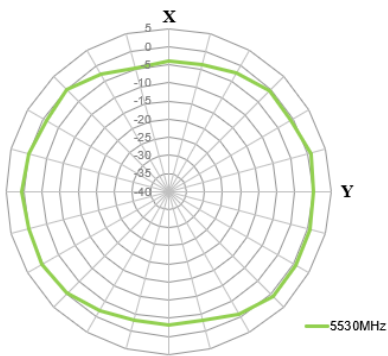

4.9 Test Setup – Bent In Centre 30X30cm Ground plane

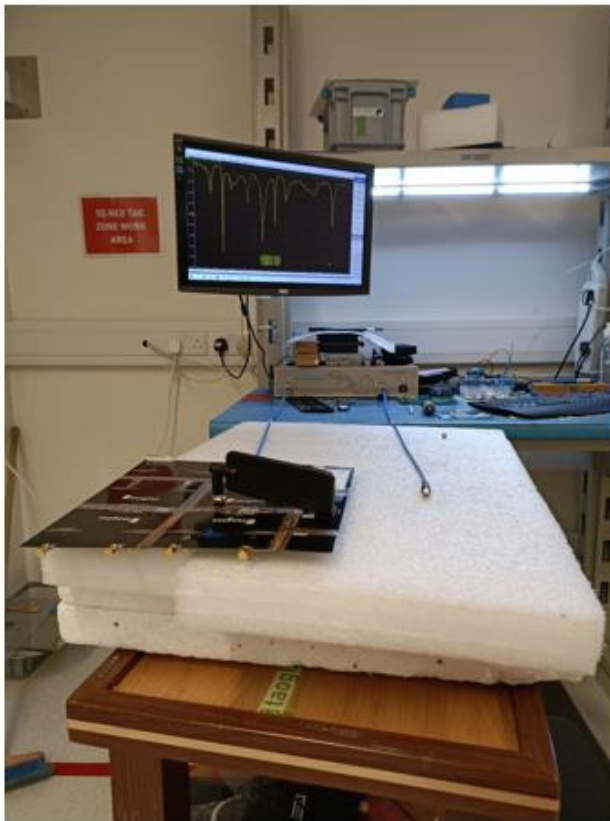

VNA Setup - Bent in center of 30X30cm Ground plane

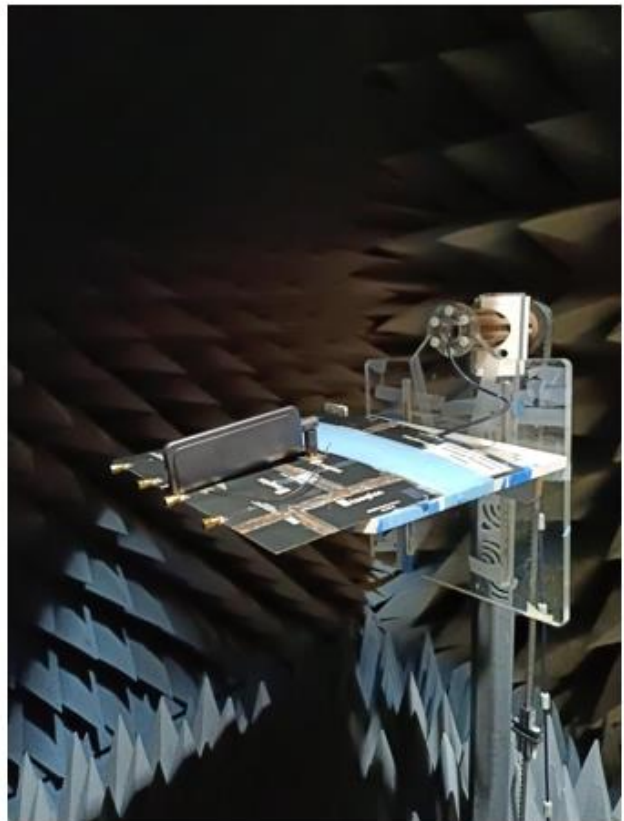

Chamber Setup – Bent in center of 30X30cm Ground plane

4.10 650MHz Bent In Centre 30X30cm Ground plane 2D & 3D Radiation Patterns

Azimuth = 0.0  
Elevation = 0.0  
Roll = -45.0

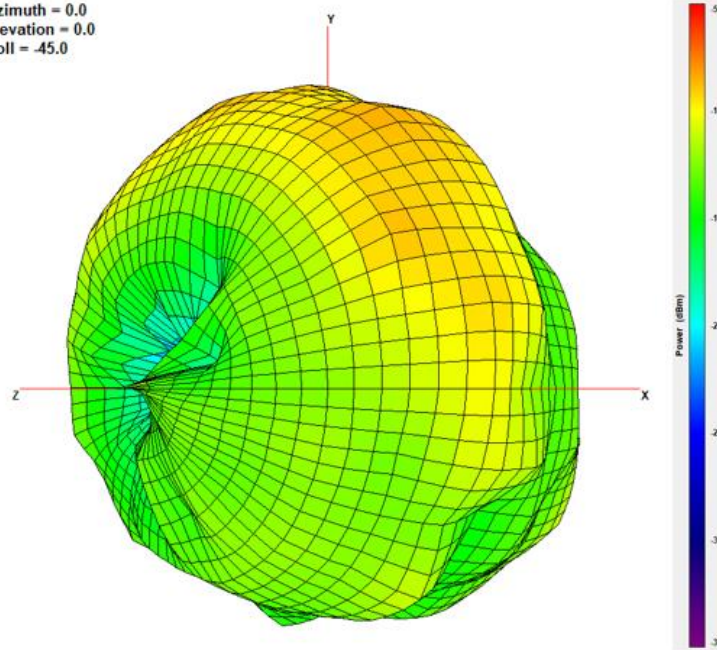

XY Plane

XZ Plane

YZ Plane

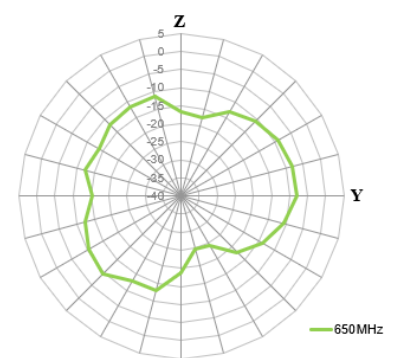
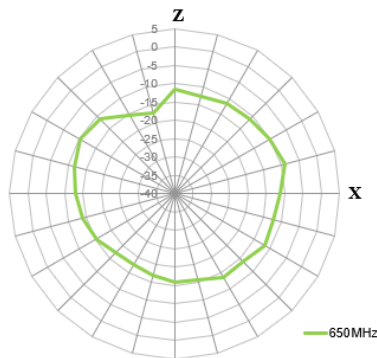
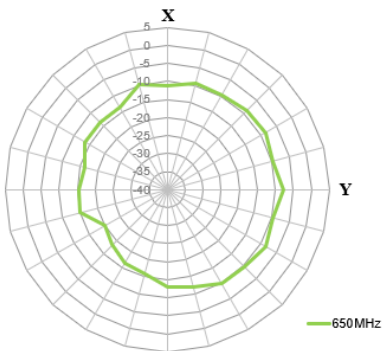

# 750MHz

Azimuth = 0.0  
Elevation = 0.0  
Roll = -45.0

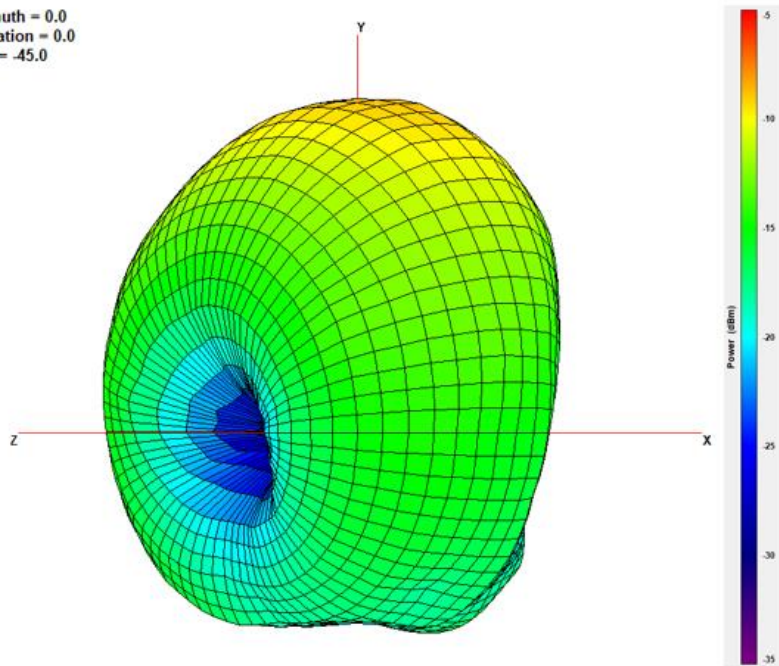

XY Plane

XZ Plane

YZ Plane

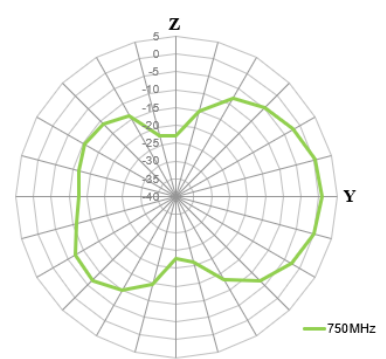
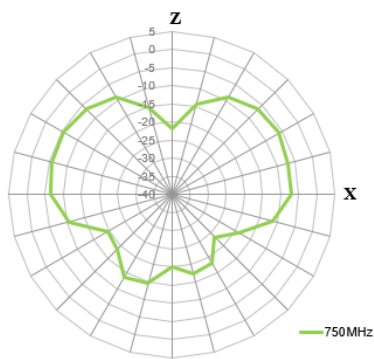
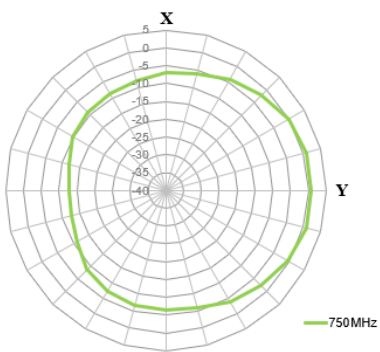

# 890MHz

Azimuth = 0.0  
Elevation = 0.0  
Roll = -45.0

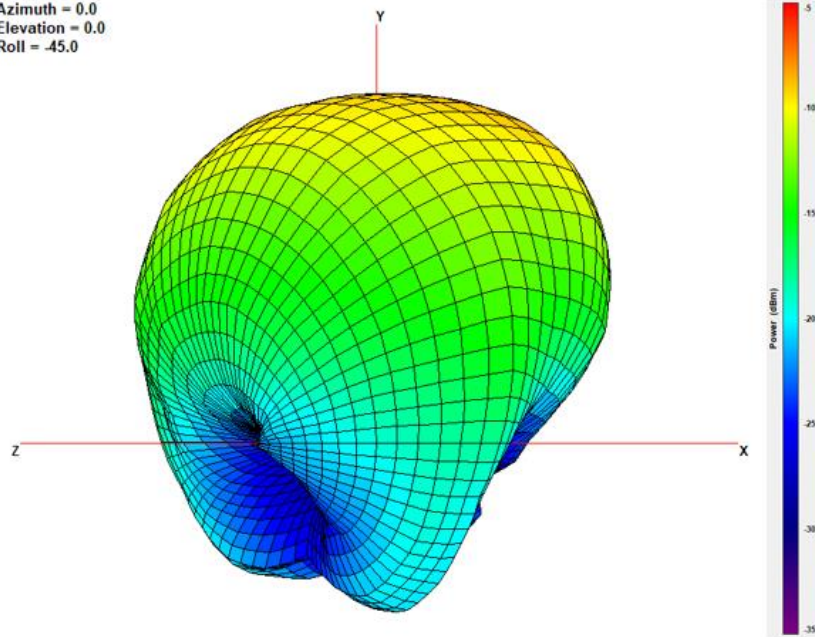

XY Plane

XZ Plane

YZ Plane

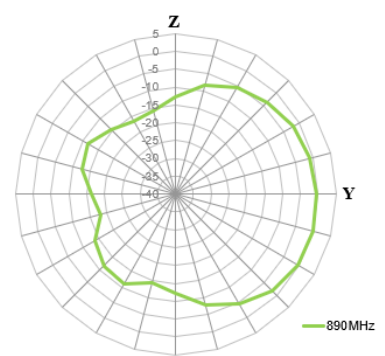
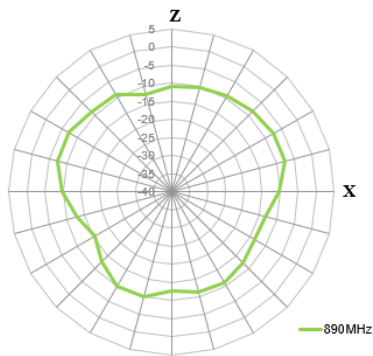
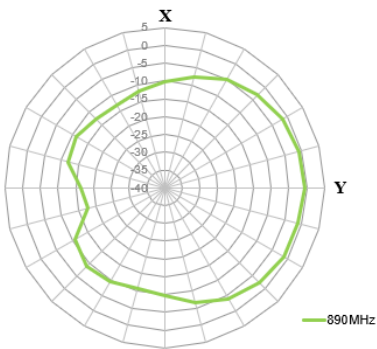



# 1470MHz

Azimuth = 0.0  
Elevation = 0.0  
Roll = -45.0

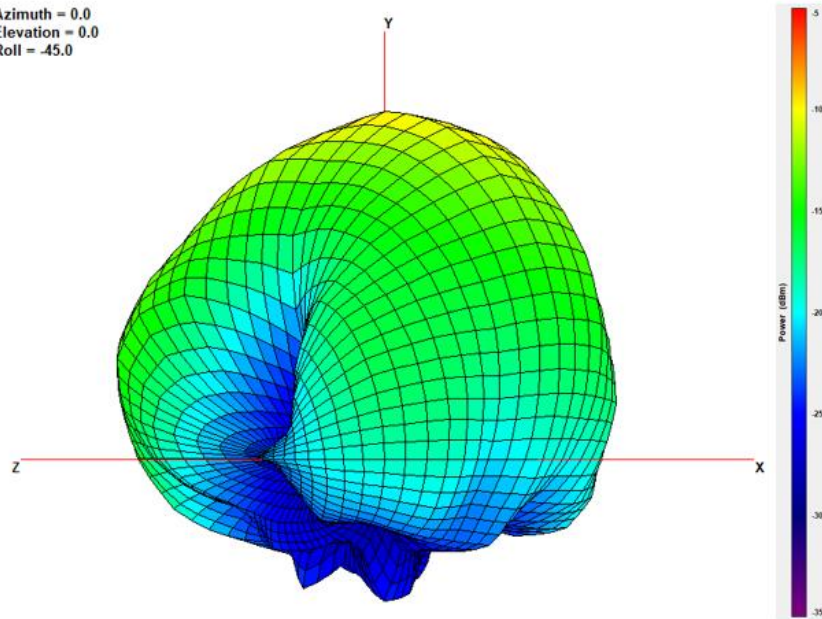

XY Plane

XZ Plane

YZ Plane

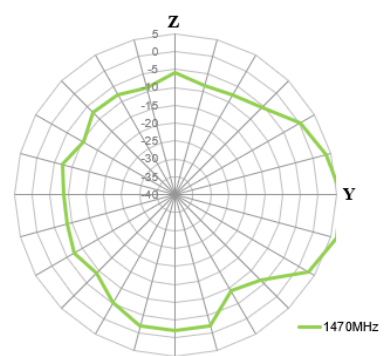
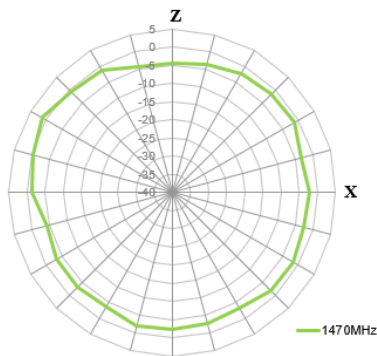
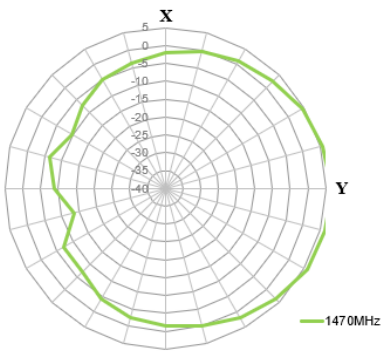

# 1805MHz

Azimuth = 0.0  
Elevation = 0.0  
Roll = -45.0

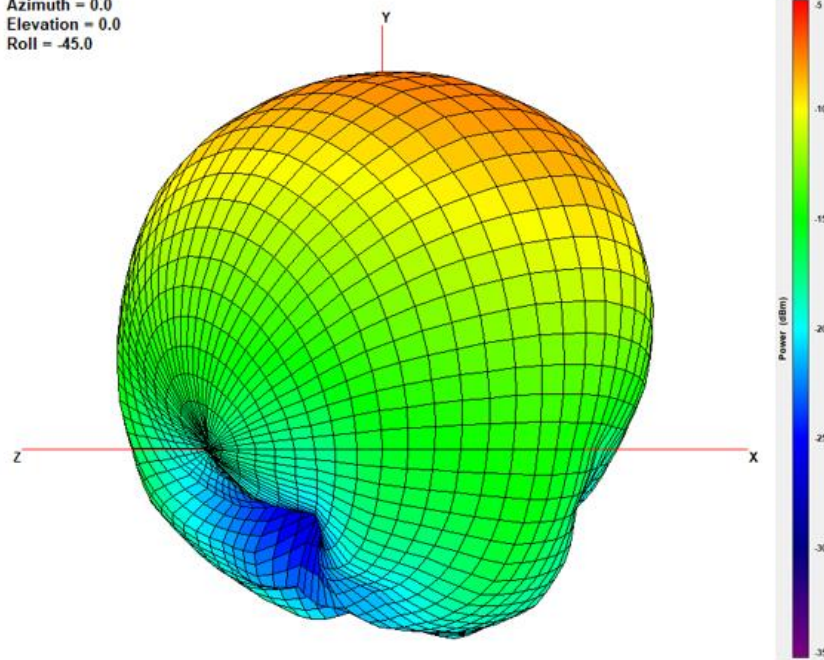

XY Plane

XZ Plane

YZ Plane

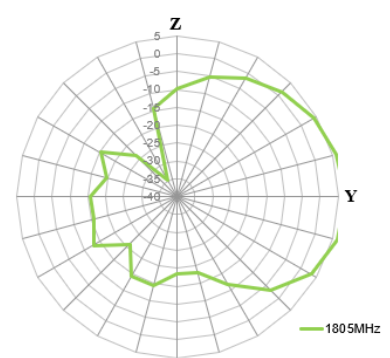
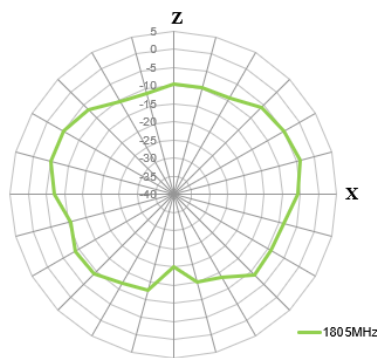
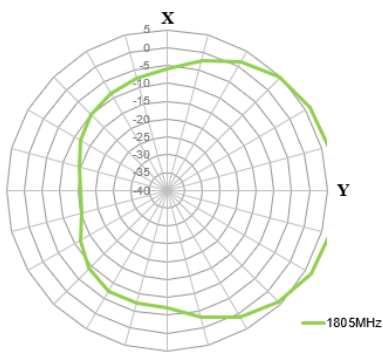

# 1920MHz

Azimuth = 0.0  
Elevation = 0.0  
Roll = -45.0

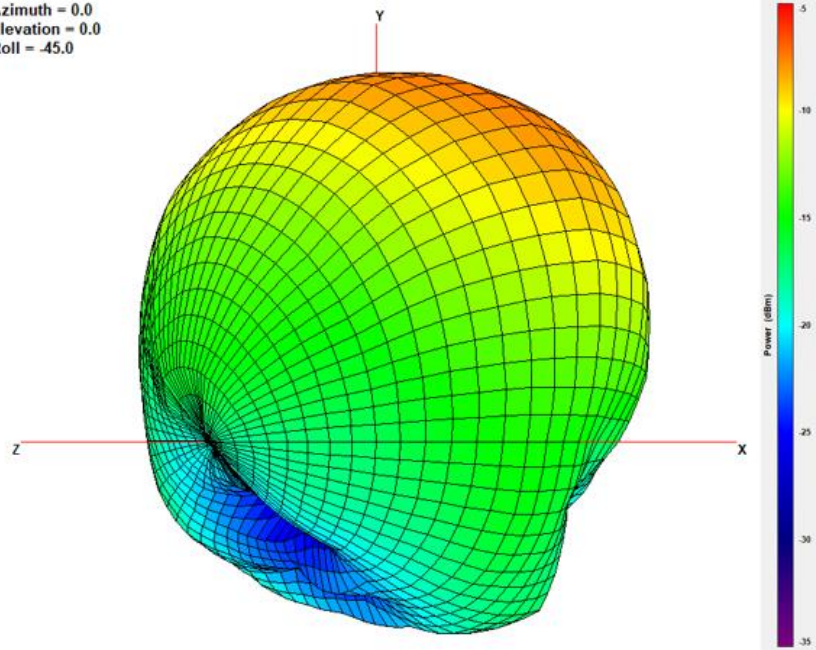

XY Plane

XZ Plane

YZ Plane

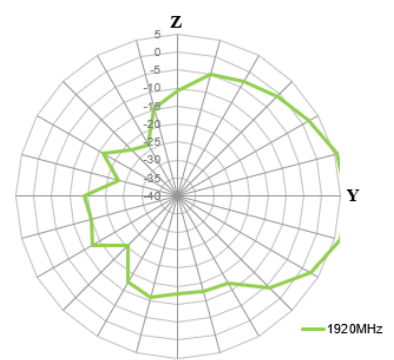
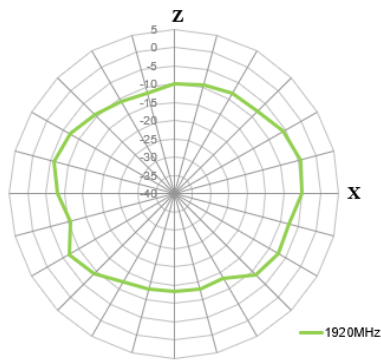
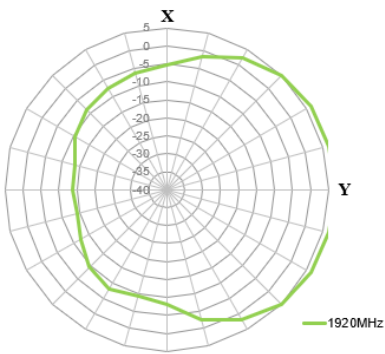

# 1990MHz

Azimuth = 0.0  
Elevation = 0.0  
Roll = -45.0

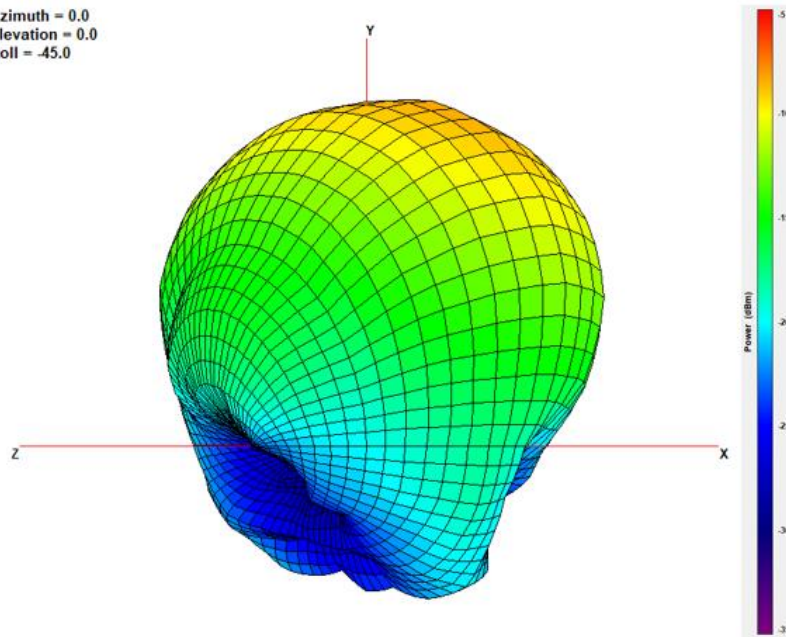

XY Plane

XZ Plane

YZ Plane

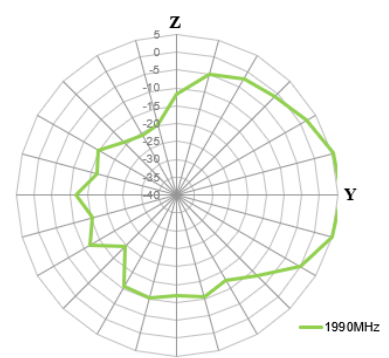
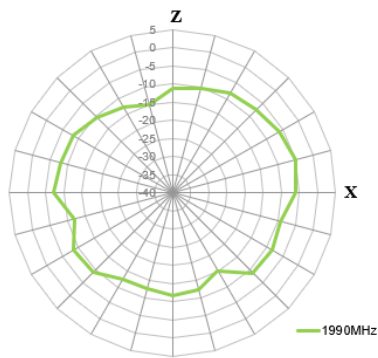
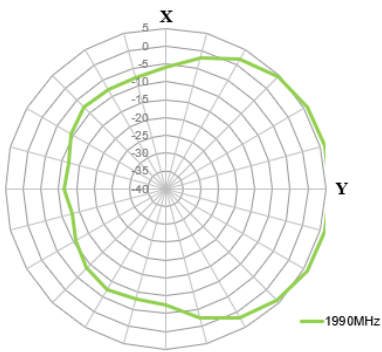

2595MHz

Azimuth = 0.0  
Elevation = 0.0  
Roll = -45.0

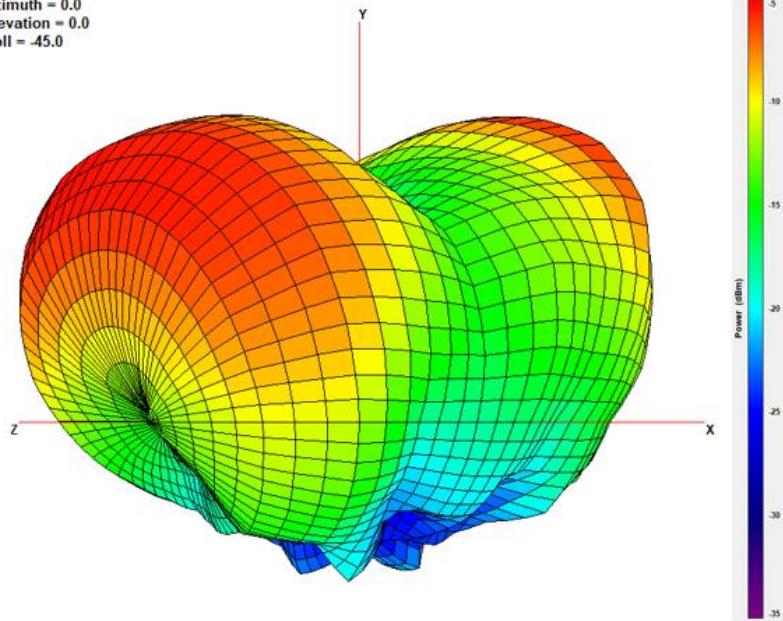

XY Plane

XZ Plane

YZ Plane

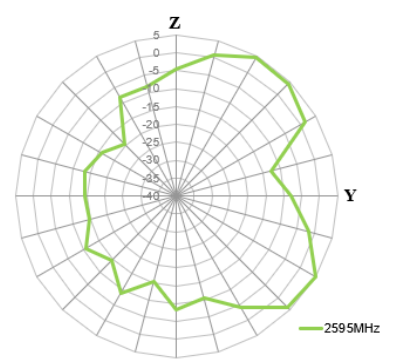
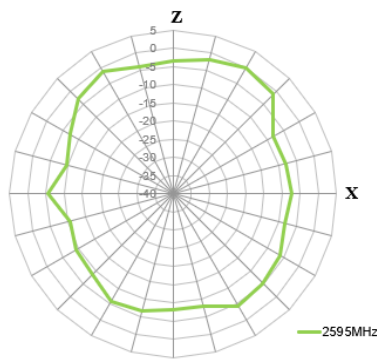
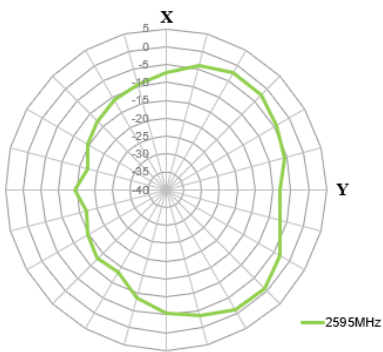

# 3550MHz

Azimuth = 0.0  
Elevation = 0.0  
Roll = -45.0

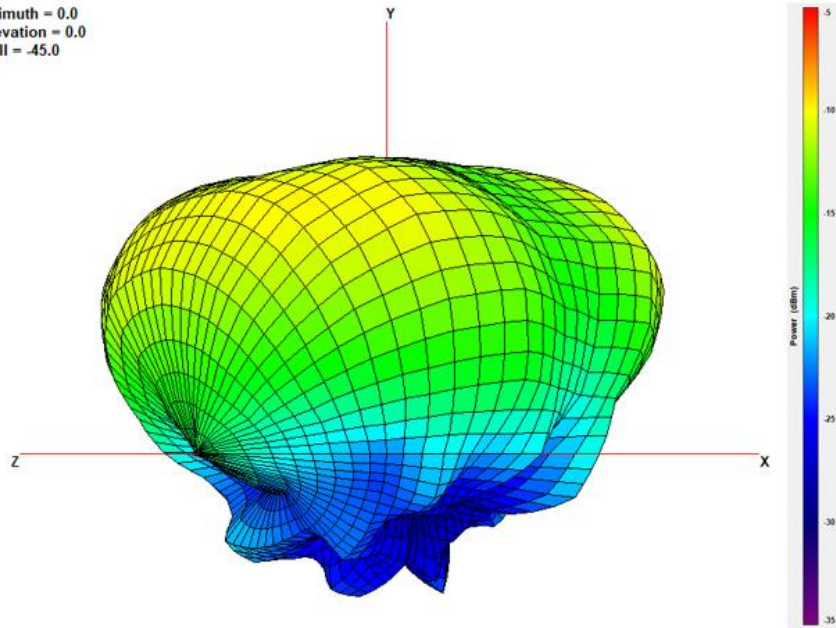

XY Plane

XZ Plane

YZ Plane

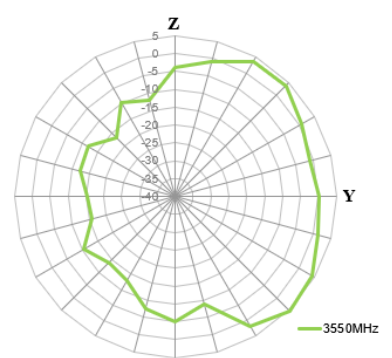
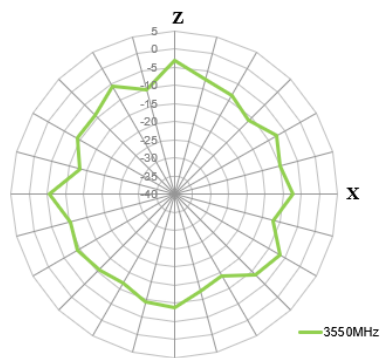
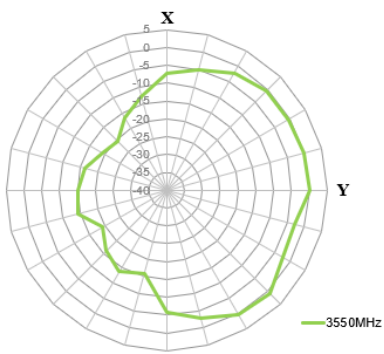

# 5530MHz

Azimuth = 0.0  
Elevation = 0.0  
Roll = -45.0

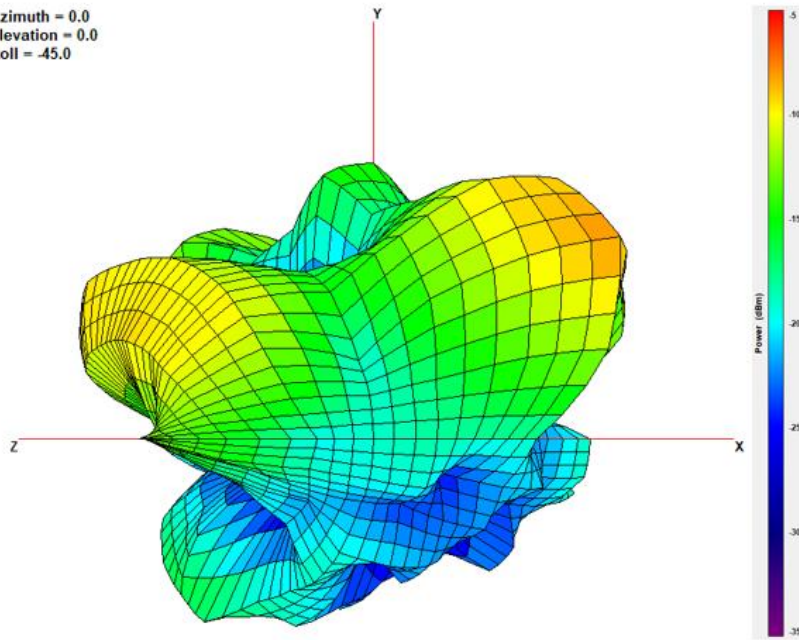

XY Plane

XZ Plane

YZ Plane

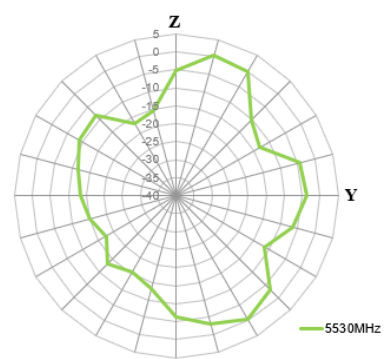
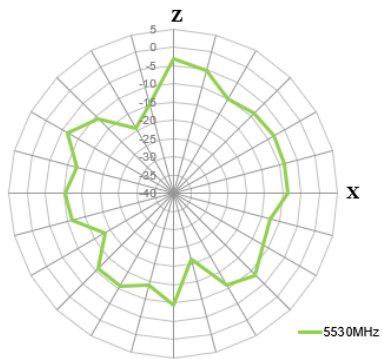
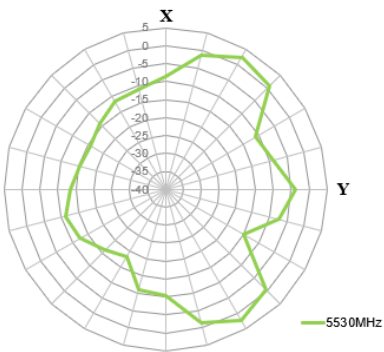

4.11 Test Setup – Straight In Centre 30X30cm Ground plane

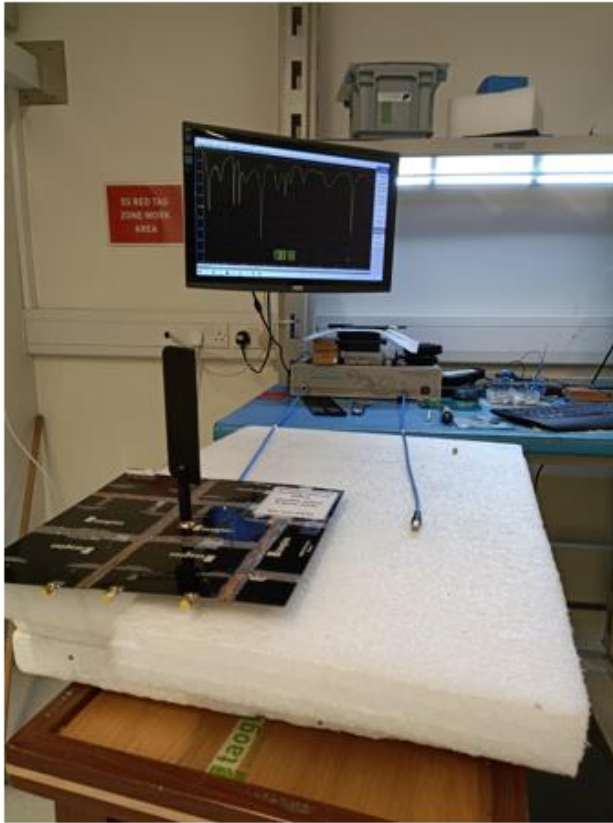

VNA Setup - Straight in centre of 30X30cm Ground plane

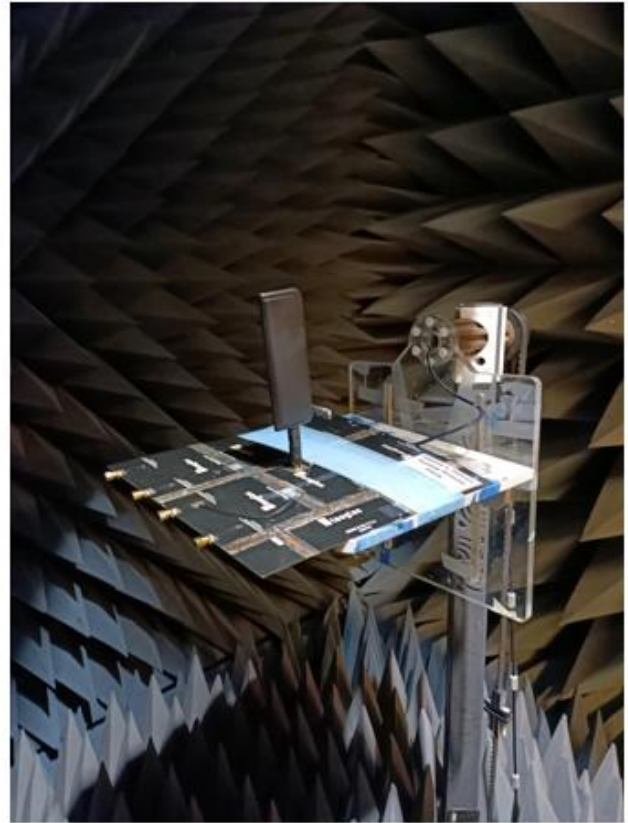

Chamber Setup - Straight in centre of 30X30cm Ground plane



4.12 650MHz Straight In Centre 30X30cm Ground plane 2D & 3D Radiation Patterns

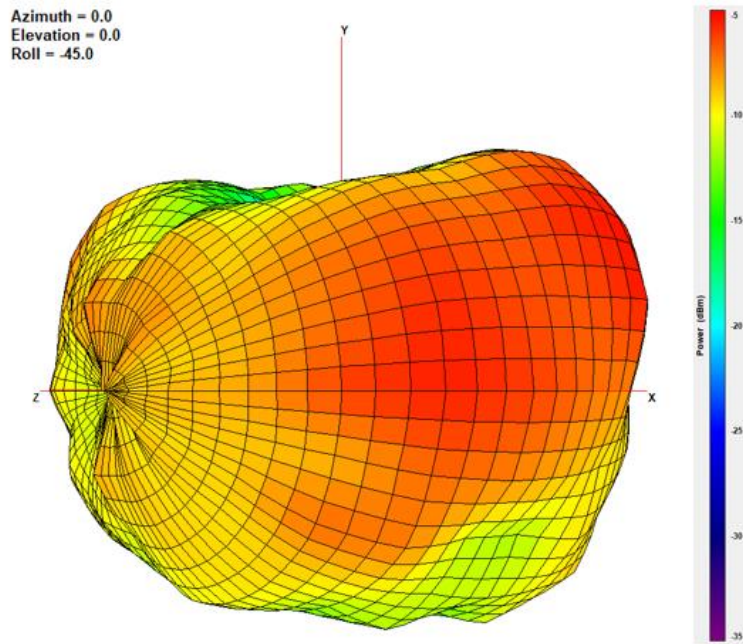

XY Plane                      XZ Plane                      YZ Plane

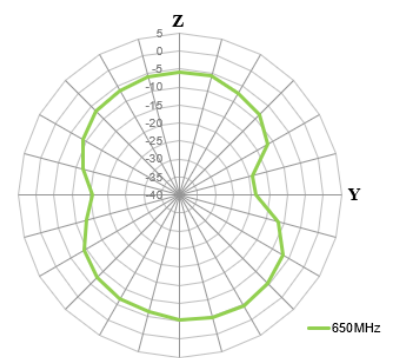
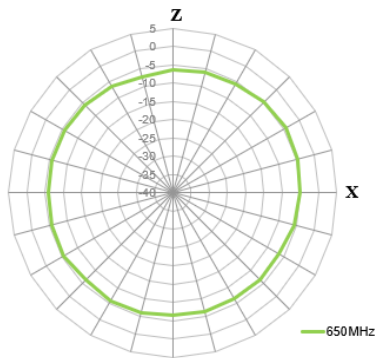
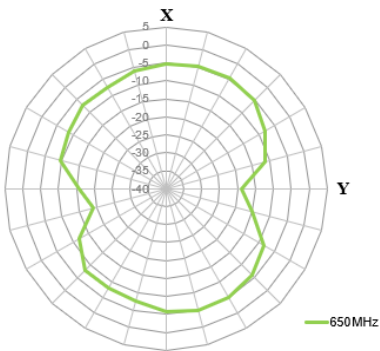

# 750MHz

Azimuth = 0.0  
Elevation = 0.0  
Roll = -45.0

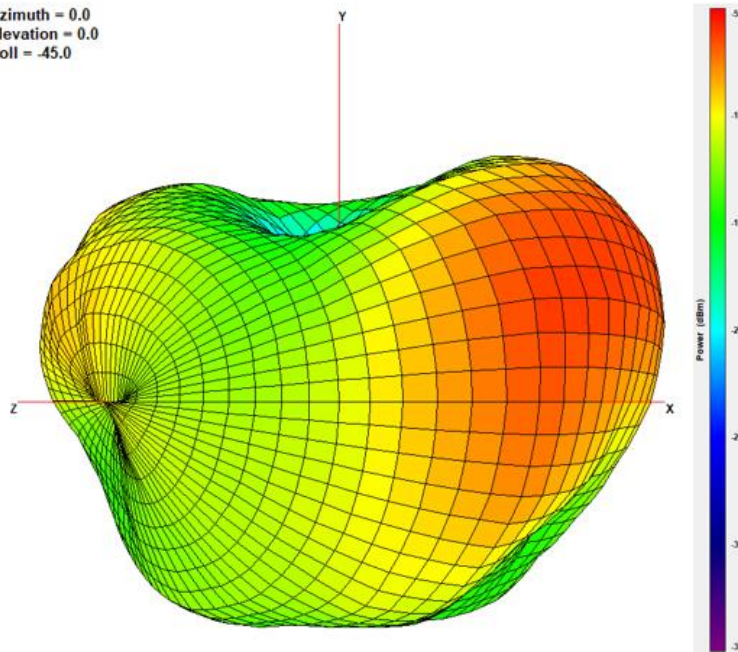

XY Plane

XZ Plane

YZ Plane

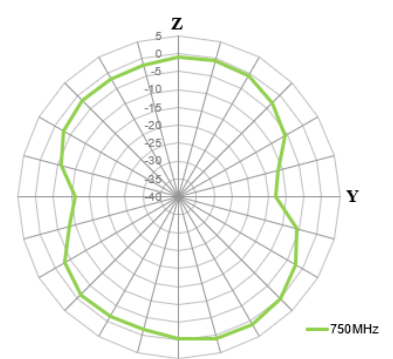
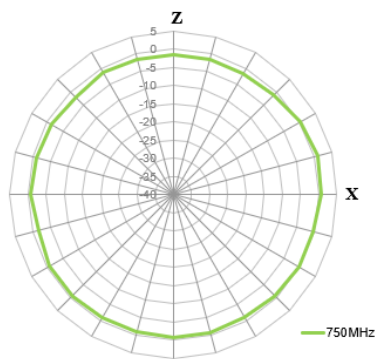
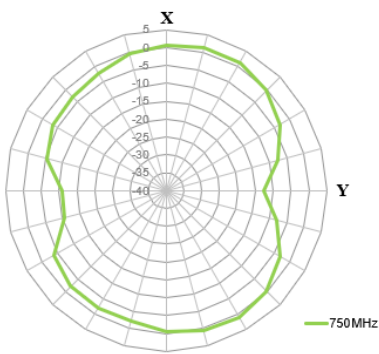

# 890MHz

Azimuth = 0.0  
Elevation = 0.0  
Roll = -45.0

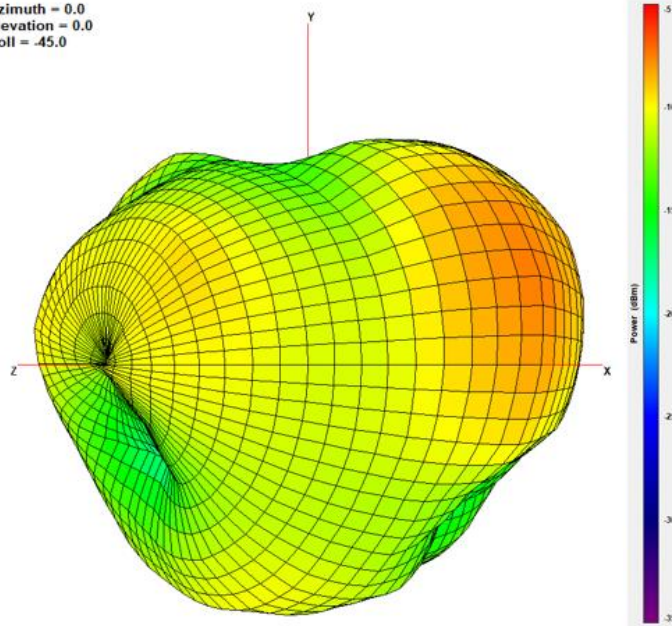

XY Plane

XZ Plane

YZ Plane

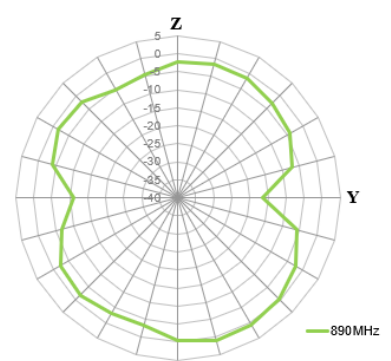
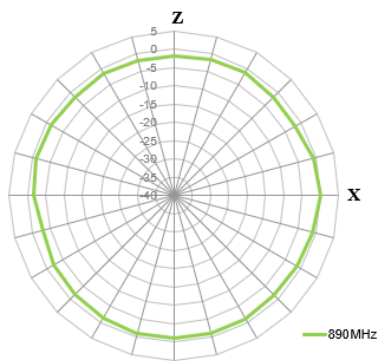
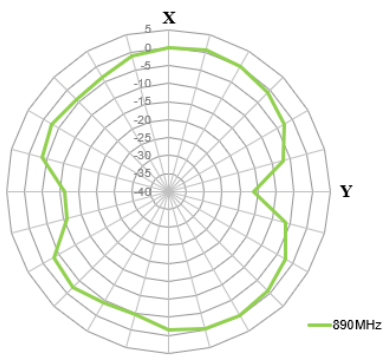

# 1470MHz

Azimuth = 0.0  
Elevation = 0.0  
Roll = -45.0

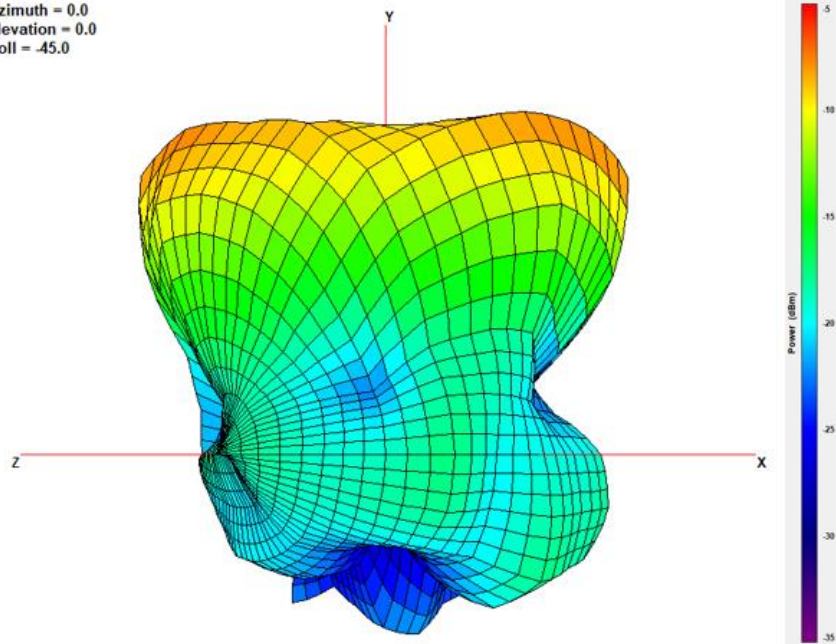

XY Plane

XZ Plane

YZ Plane

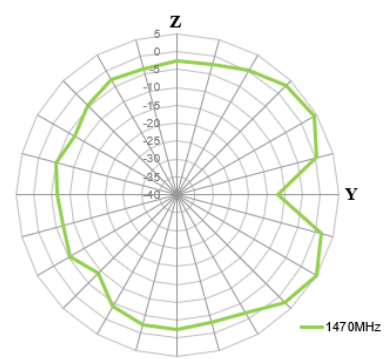
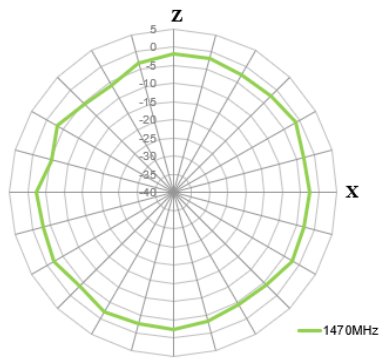
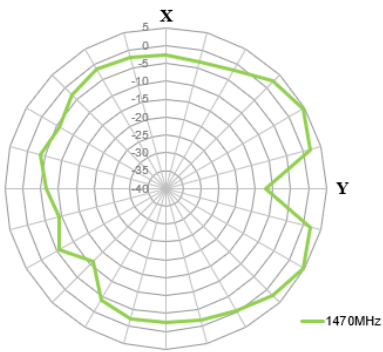

# 1805MHz

Azimuth = 0.0  
Elevation = 0.0  
Roll = -45.0

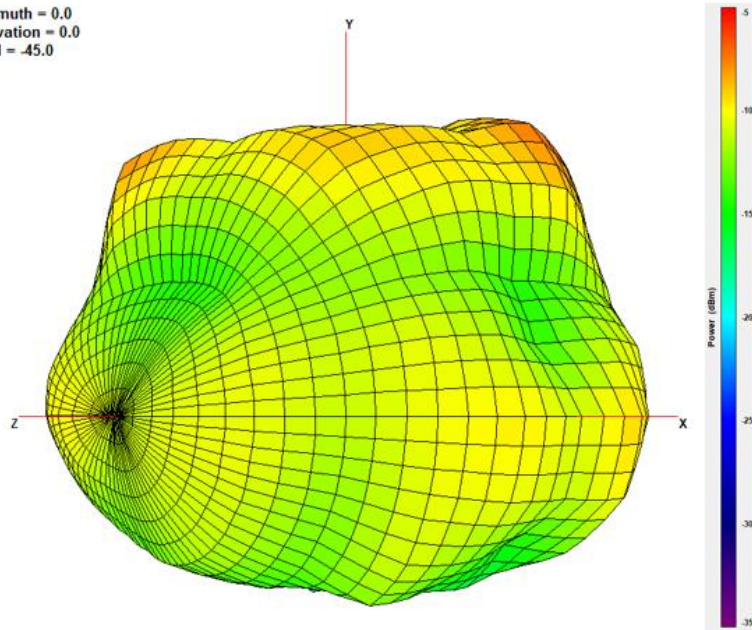

XY Plane

XZ Plane

YZ Plane

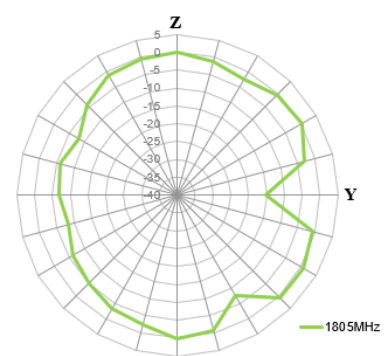
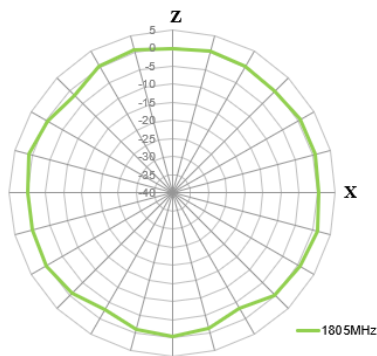
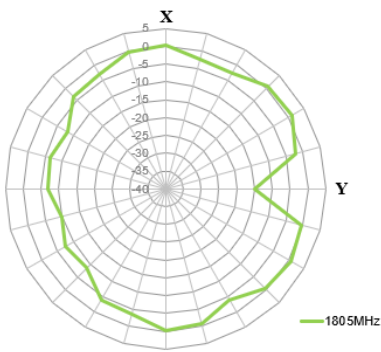

# 1920MHz

Azimuth = 0.0  
Elevation = 0.0  
Roll = -45.0

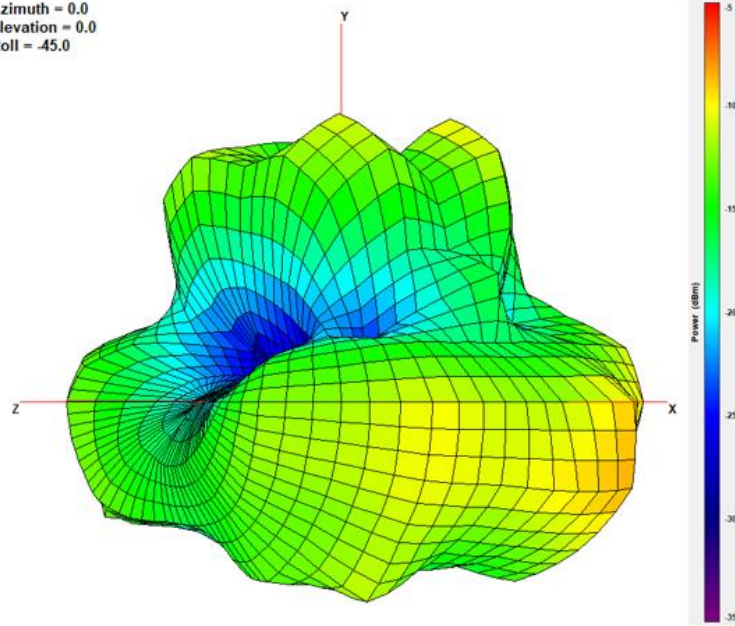

XY Plane

XZ Plane

YZ Plane

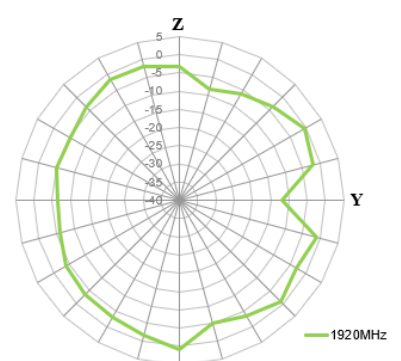
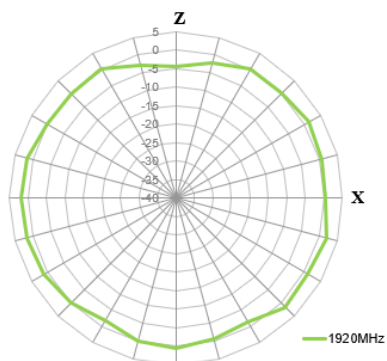
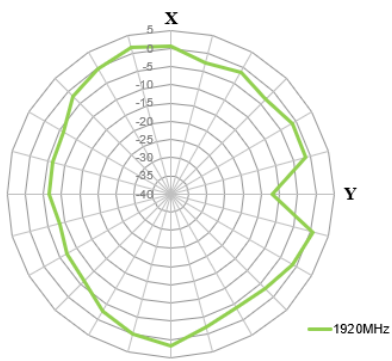

# 1990MHz

Azimuth = 0.0  
 Elevation = 0.0  
 Roll = -45.0

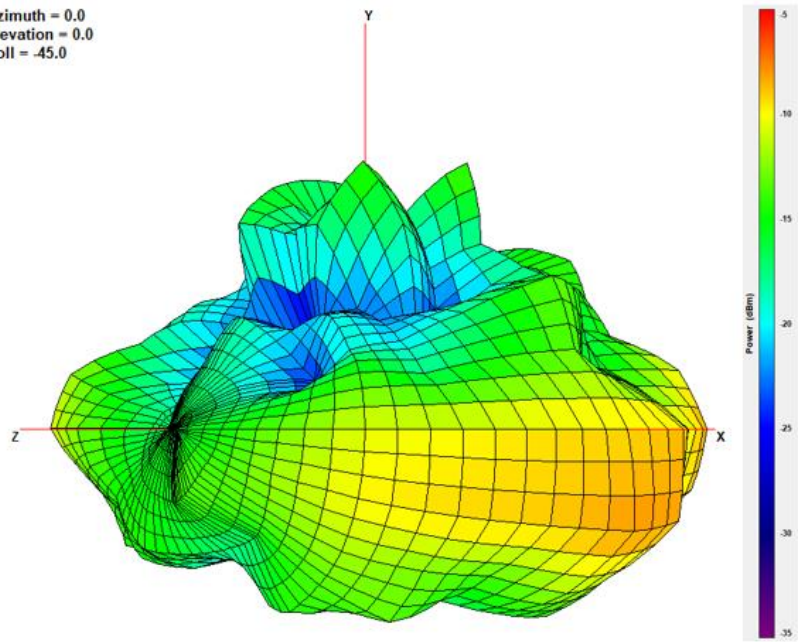

XY Plane

XZ Plane

YZ Plane

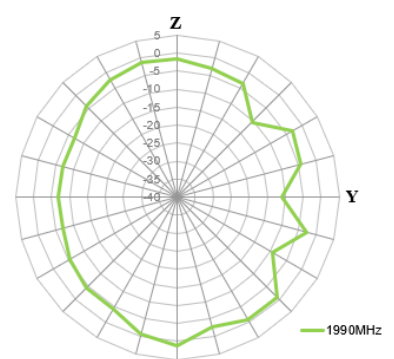
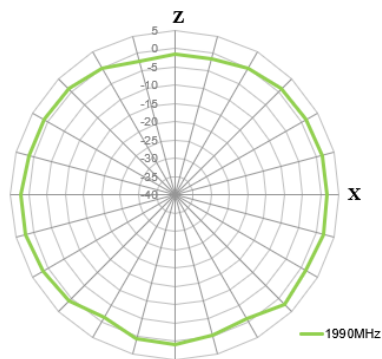
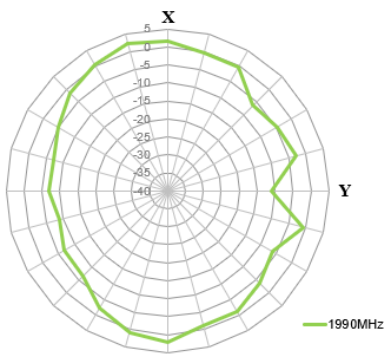

2595MHz

Azimuth = 0.0  
Elevation = 0.0  
Roll = -45.0

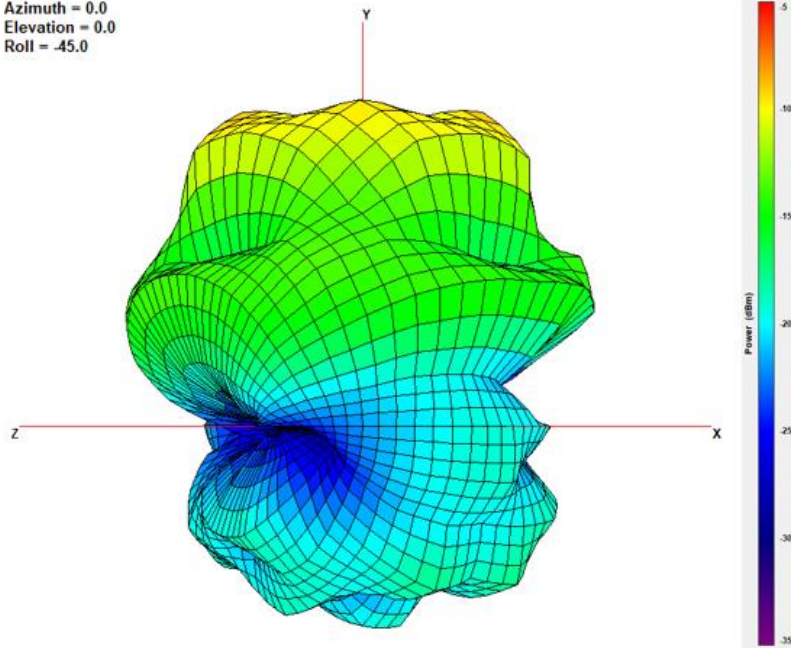

XY Plane

XZ Plane

YZ Plane

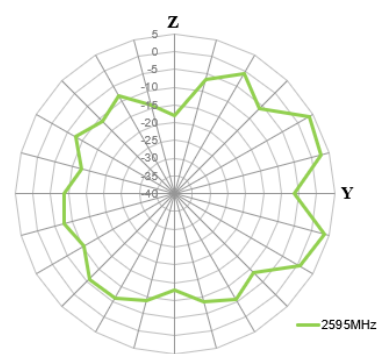
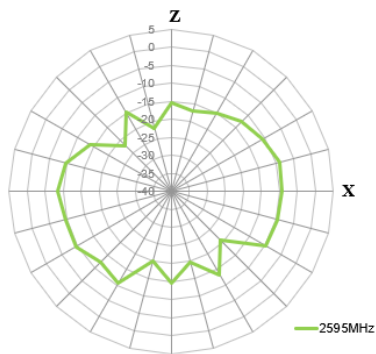
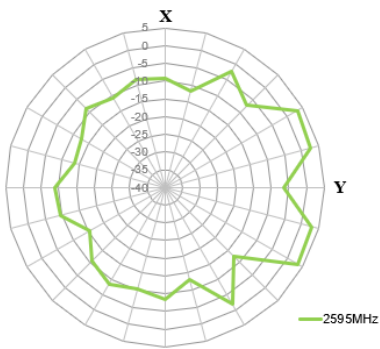



# 3550MHz

Azimuth = 0.0  
Elevation = 0.0  
Roll = -45.0

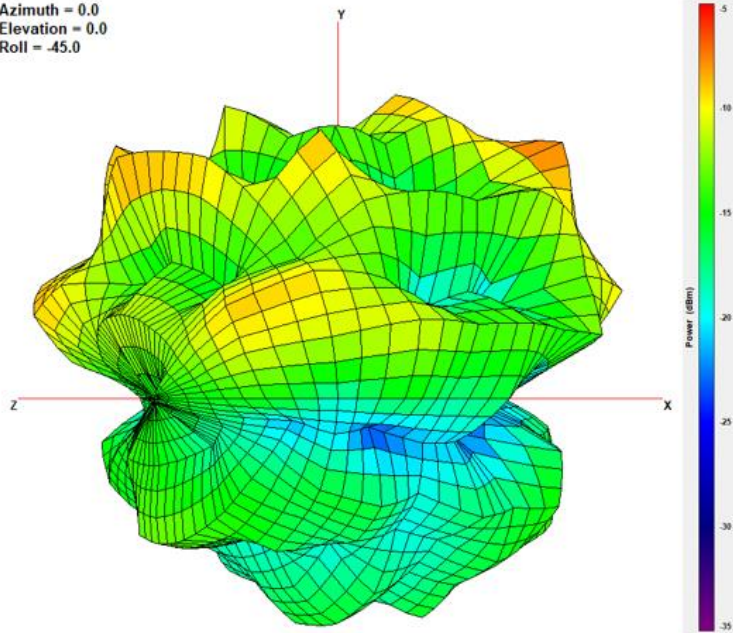

XY Plane

XZ Plane

YZ Plane

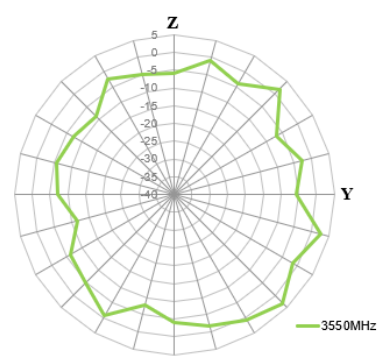
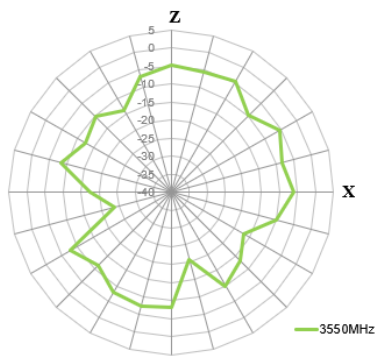
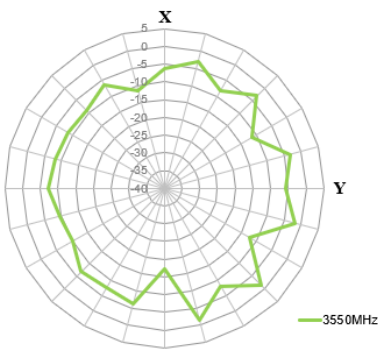

# 5530MHz

Azimuth = 0.0  
 Elevation = 0.0  
 Roll = -45.0

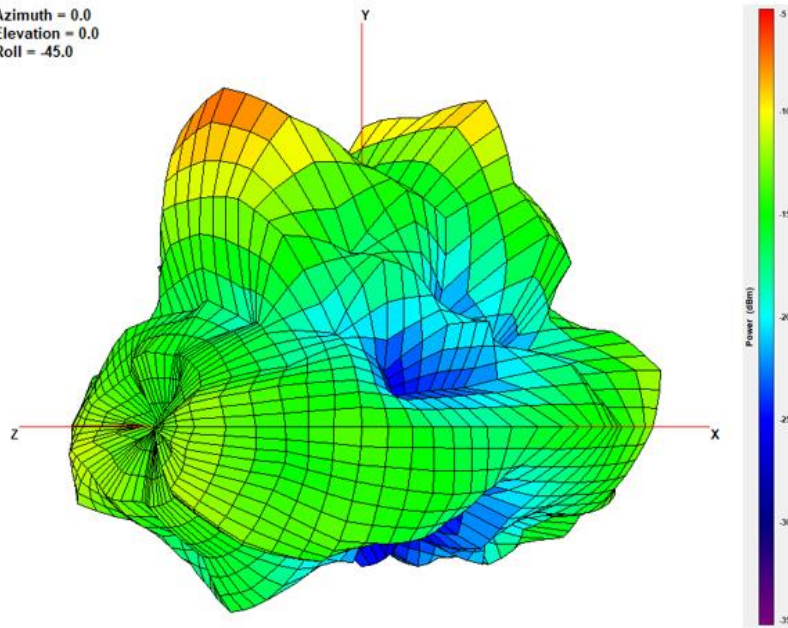

XY Plane

XZ Plane

YZ Plane

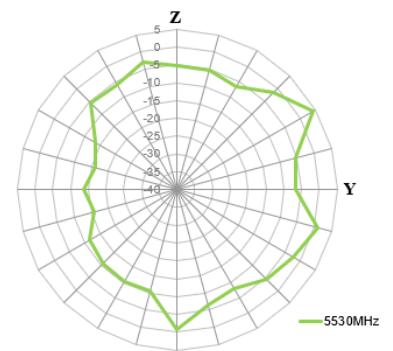
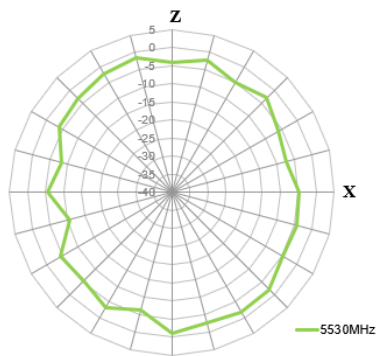
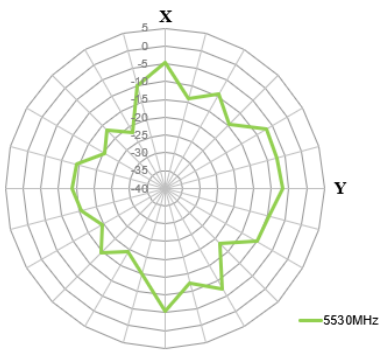

# 5. Mechanical Drawing (Units: mm)

3D View

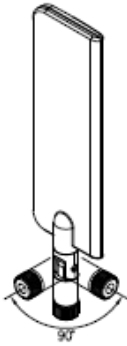

Front View

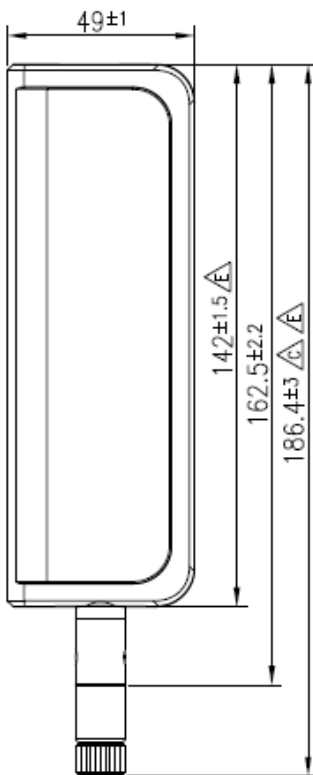

Side View

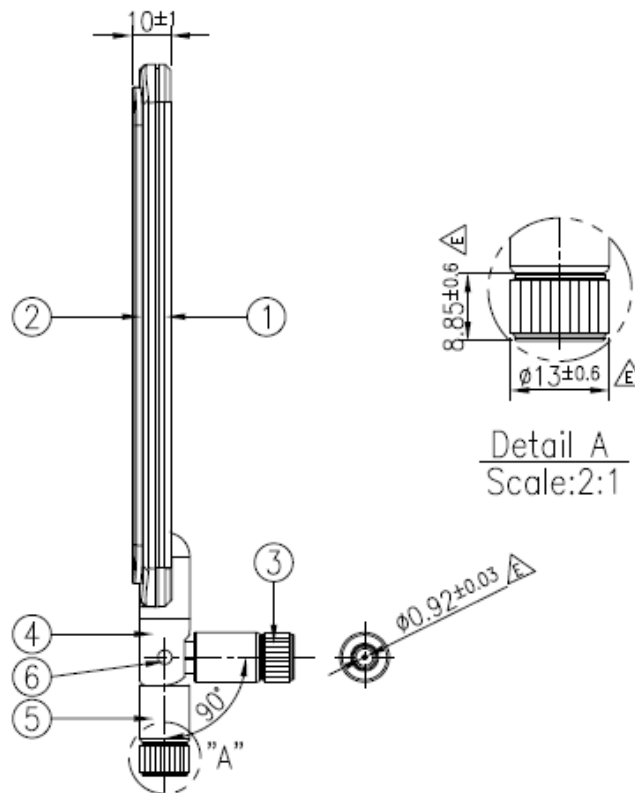

Detail A  
Scale:2:1

**NOTES:**

- 1.All material must be RoHS compliant.
- 2.Open/short, insertion loss QC required.
- 3.The connectors have a fixed orientation to each other.



	Name	P/N	Material	Finish	QTY
1	Housing_Bottom_Hinge	000112E020020A	ABS	Black	1
2	Housing_Top	000112E000020A	ABS	Black	1
3	SMA(M)ST	210212L010020A	Brass	Black	1
4	Hinge_Top	000112E040020A	Nylon	Black	1
5	Hinge_Bottom	000112E030020A	PC+PBT	Black	1
6	Rotary Shaft	000611I000002A	Brass	Black	2

## 6. Packaging

1pc TG.30.8113 per Small PE Bag  
 Small PE Bag Dimensions - 210\*78mm  
 Weight - 127g



50pcs TG.30.8113 per Large PE Bag  
 Large PE Bag Dimensions - 450\*275mm  
 Weight - 6.35Kg

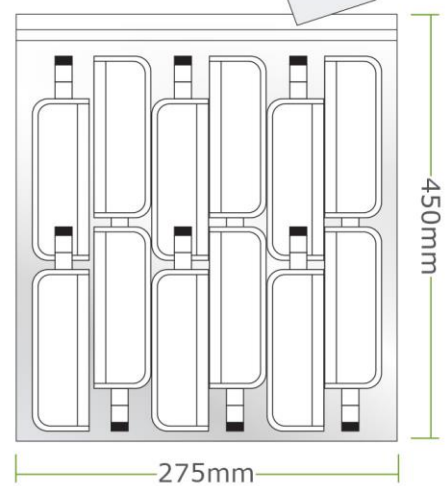

Changelog for the datasheet

**SPE-12-8-124 - TG.30.8113**

**Revision: L (Current Version)**

Date:	2022-09-26
Changes:	Updated specifications
Changes Made by:	Cesar Sousa

**Previous Revisions**

**Revision: K**

Date:	2022-04-04
Changes:	Full datasheet template update and show data 600-6000.
Changes Made by:	Gary West

**Revision: F**

Date:	2018-03-23
Changes:	
Changes Made by:	Technical Writer

**Revision: J**

Date:	2018-08-16
Changes:	
Changes Made by:	Technical Writer

**Revision: E**

Date:	2018-03-13
Changes:	
Changes Made by:	Technical Writer

**Revision: I**

Date:	2018-08-14
Changes:	Change to IP Rating - Removed
Changes Made by:	David Connolly

**Revision: D**

Date:	2017-05-10
Changes:	
Changes Made by:	Technical Writer

**Revision: H**

Date:	2018-06-14
Changes:	Re-tested "Bent on Ground Planer Edge" configuration and results are much improved and consistent with the other three test configuration results.
Changes Made by:	Technical Writer

**Revision: C**

Date:	2017-04-04
Changes:	Updated Spec with LTE table
Changes Made by:	Andy Mahoney

**Revision: G**

Date:	2018-05-08
Changes:	
Changes Made by:	Technical Writer

**Revision: B**

Date:	2017-01-13
Changes:	
Changes Made by:	Technical Writer

---

**Previous Revisions (Continued)**

<b>Revision: A (Original First Release)</b>		
Date:	2012-10-02	
Notes:		
Author:	Technical Writer	



**TAOGLAS**®

[www.taoglas.com](http://www.taoglas.com)

