

General Purpose Transistors

NPN Silicon

MMBT2222L, MMBT2222AL, SMMBT2222AL

Features

- These Devices are Pb-Free, Halogen Free/BFR Free and are RoHS Compliant
- S Prefix for Automotive and Other Applications Requiring Unique Site and Control Change Requirements; AEC-Q101 Qualified and PPAP Capable

MAXIMUM RATINGS

Rating	Symbol	Value	Unit
Collector – Emitter Voltage MMBT2222L MMBT2222AL, SMMBT2222AL	V_{CEO}	30 40	Vdc
Collector – Base Voltage MMBT2222L MMBT2222AL, SMMBT2222AL	V_{CBO}	60 75	Vdc
Emitter – Base Voltage MMBT2222L MMBT2222AL, SMMBT2222AL	V_{EBO}	5.0 6.0	Vdc
Collector Current – Continuous	I_C	600	mAdc
Collector Current – Peak (Note 3)	I_{CM}	1100	mAdc

THERMAL CHARACTERISTICS

Characteristic	Symbol	Max	Unit
Total Device Dissipation FR-5 Board (Note 1) $T_A = 25^\circ\text{C}$ Derate above 25°C	P_D	225 1.8	mW mW/ $^\circ\text{C}$
Thermal Resistance, Junction-to-Ambient	$R_{\theta JA}$	556	$^\circ\text{C}/\text{W}$
Total Device Dissipation Alumina Substrate (Note 2) $T_A = 25^\circ\text{C}$ Derate above 25°C	P_D	300 2.4	mW mW/ $^\circ\text{C}$
Thermal Resistance, Junction-to-Ambient	$R_{\theta JA}$	417	$^\circ\text{C}/\text{W}$
Junction and Storage Temperature Range	T_J, T_{stg}	-55 to +150	$^\circ\text{C}$

Stresses exceeding those listed in the Maximum Ratings table may damage the device. If any of these limits are exceeded, device functionality should not be assumed, damage may occur and reliability may be affected.

1. FR-5 = $1.0 \times 0.75 \times 0.062$ in.
2. Alumina = $0.4 \times 0.3 \times 0.024$ in. 99.5% alumina.
3. Reference SOA curve.

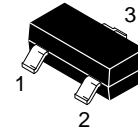
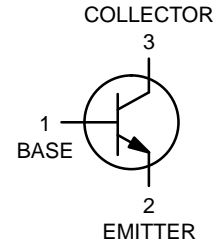

SOT-23
CASE 318
STYLE 6

MARKING DIAGRAM

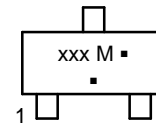

xxx = 1P or M1B
M = Date Code*
▪ = Pb-Free Package

(Note: Microdot may be in either location)

*Date Code orientation and/or overbar may vary depending upon manufacturing location.

ORDERING INFORMATION

See detailed ordering and shipping information in the package dimensions section on page 6 of this data sheet.

MMBT2222L, MMBT2222AL, SMMBT2222AL

ELECTRICAL CHARACTERISTICS (T_A = 25°C unless otherwise noted)

Characteristic	Symbol	Min	Max	Unit	
OFF CHARACTERISTICS					
Collector–Emitter Breakdown Voltage (I _C = 10 mAdc, I _B = 0)	MMBT2222 MMBT2222A	V _{(BR)CEO}	30 40	– –	Vdc
Collector–Base Breakdown Voltage (I _C = 10 μAdc, I _E = 0)	MMBT2222 MMBT2222A	V _{(BR)CBO}	60 75	– –	Vdc
Emitter–Base Breakdown Voltage (I _E = 10 μAdc, I _C = 0)	MMBT2222 MMBT2222A	V _{(BR)EBO}	5.0 6.0	– –	Vdc
Collector Cutoff Current (V _{CE} = 60 Vdc, V _{EB(off)} = 3.0 Vdc)	MMBT2222A, SMMBT2222A	I _{CEX}	–	10	nAdc
Collector Cutoff Current (V _{CB} = 50 Vdc, I _E = 0)	MMBT2222 MMBT2222A, SMMBT2222A	I _{CBO}	–	0.01	μAdc
(V _{CB} = 60 Vdc, I _E = 0)	MMBT2222A, SMMBT2222A		–	0.01	
(V _{CB} = 50 Vdc, I _E = 0, T _A = 125°C)	MMBT2222		–	10	
(V _{CB} = 60 Vdc, I _E = 0, T _A = 125°C)	MMBT2222A, SMMBT2222A		–	10	
Emitter Cutoff Current (V _{EB} = 3.0 Vdc, I _C = 0)	MMBT2222A, SMMBT2222A	I _{EBO}	–	100	nAdc
Base Cutoff Current (V _{CE} = 60 Vdc, V _{EB(off)} = 3.0 Vdc)	MMBT2222A, SMMBT2222A	I _{BL}	–	20	nAdc
ON CHARACTERISTICS					
DC Current Gain (I _C = 0.1 mAdc, V _{CE} = 10 Vdc) (I _C = 1.0 mAdc, V _{CE} = 10 Vdc) (I _C = 10 mAdc, V _{CE} = 10 Vdc) (I _C = 10 mAdc, V _{CE} = 10 Vdc, T _A = –55°C) (I _C = 150 mAdc, V _{CE} = 10 Vdc) (Note 4) (I _C = 150 mAdc, V _{CE} = 1.0 Vdc) (Note 4) (I _C = 500 mAdc, V _{CE} = 10 Vdc) (Note 4)	MMBT2222A only MMBT2222 MMBT2222A, SMMBT2222A	h _{FE}	35 50 75 35 100 50 30 40	– – – – 300 – – –	–
Collector–Emitter Saturation Voltage (Note 4) (I _C = 150 mAdc, I _B = 15 mAdc)	MMBT2222 MMBT2222A, SMMBT2222A	V _{CE(sat)}	– –	0.4 0.3	Vdc
(I _C = 500 mAdc, I _B = 50 mAdc)	MMBT2222 MMBT2222A, SMMBT2222A		– –	1.6 1.0	
Base–Emitter Saturation Voltage (Note 4) (I _C = 150 mAdc, I _B = 15 mAdc)	MMBT2222 MMBT2222A, SMMBT2222A	V _{BE(sat)}	– 0.6	1.3 1.2	Vdc
(I _C = 500 mAdc, I _B = 50 mAdc)	MMBT2222 MMBT2222A, SMMBT2222A		– –	2.6 2.0	
SMALL–SIGNAL CHARACTERISTICS					
Current–Gain – Bandwidth Product (Note 5) (I _C = 20 mAdc, V _{CE} = 20 Vdc, f = 100 MHz)	MMBT2222 MMBT2222A, SMMBT2222A	f _T	250 300	– –	MHz
Output Capacitance (V _{CB} = 10 Vdc, I _E = 0, f = 1.0 MHz)		C _{obo}	–	8.0	pF
Input Capacitance (V _{EB} = 0.5 Vdc, I _C = 0, f = 1.0 MHz)	MMBT2222 MMBT2222A, SMMBT2222A	C _{ibo}	– –	30 25	pF
Input Impedance (I _C = 1.0 mAdc, V _{CE} = 10 Vdc, f = 1.0 kHz) (I _C = 10 mAdc, V _{CE} = 10 Vdc, f = 1.0 kHz)	MMBT2222A, SMMBT2222A MMBT2222A, SMMBT2222A	h _{ie}	2.0 0.25	8.0 1.25	kΩ
Voltage Feedback Ratio (I _C = 1.0 mAdc, V _{CE} = 10 Vdc, f = 1.0 kHz) (I _C = 10 mAdc, V _{CE} = 10 Vdc, f = 1.0 kHz)	MMBT2222A, SMMBT2222A MMBT2222A, SMMBT2222A	h _{re}	– –	8.0 4.0	X 10 ^{–4}
Small–Signal Current Gain (I _C = 1.0 mAdc, V _{CE} = 10 Vdc, f = 1.0 kHz) (I _C = 10 mAdc, V _{CE} = 10 Vdc, f = 1.0 kHz)	MMBT2222A, SMMBT2222A MMBT2222A, SMMBT2222A	h _{fe}	50 75	300 375	–

MMBT2222L, MMBT2222AL, SMMBT2222AL

ELECTRICAL CHARACTERISTICS ($T_A = 25^\circ\text{C}$ unless otherwise noted)

Characteristic	Symbol	Min	Max	Unit
SMALL-SIGNAL CHARACTERISTICS				
Output Admittance ($I_C = 1.0\text{ mA dc}$, $V_{CE} = 10\text{ V dc}$, $f = 1.0\text{ kHz}$) ($I_C = 10\text{ mA dc}$, $V_{CE} = 10\text{ V dc}$, $f = 1.0\text{ kHz}$)	h_{oe}	5.0 25	35 200	μmhos
Collector Base Time Constant ($I_E = 20\text{ mA dc}$, $V_{CB} = 20\text{ V dc}$, $f = 31.8\text{ MHz}$)	r_b, C_c	-	150	ps
Noise Figure ($I_C = 100\ \mu\text{A dc}$, $V_{CE} = 10\text{ V dc}$, $R_S = 1.0\text{ k}\Omega$, $f = 1.0\text{ kHz}$)	NF	-	4.0	dB

SWITCHING CHARACTERISTICS (MMBT2222A only)

Delay Time	$(V_{CC} = 30\text{ V dc}$, $V_{BE(\text{off})} = -0.5\text{ V dc}$, $I_C = 150\text{ mA dc}$, $I_{B1} = 15\text{ mA dc}$)	t_d	-	10	ns
Rise Time		t_r	-	25	
Storage Time	$(V_{CC} = 30\text{ V dc}$, $I_C = 150\text{ mA dc}$, $I_{B1} = I_{B2} = 15\text{ mA dc}$)	t_s	-	225	ns
Fall Time		t_f	-	60	

Product parametric performance is indicated in the Electrical Characteristics for the listed test conditions, unless otherwise noted. Product performance may not be indicated by the Electrical Characteristics if operated under different conditions.

4. Pulse Test: Pulse Width $\leq 300\ \mu\text{s}$, Duty Cycle $\leq 2.0\%$.

5. f_T is defined as the frequency at which $|h_{fe}|$ extrapolates to unity.

SWITCHING TIME EQUIVALENT TEST CIRCUITS

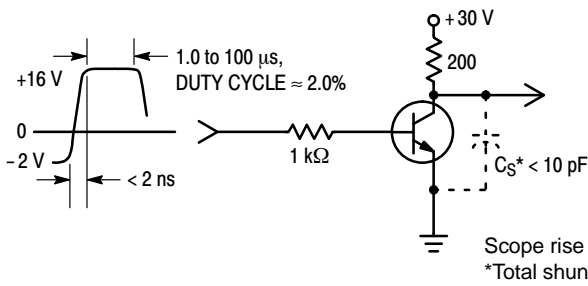

Figure 1. Turn-On Time

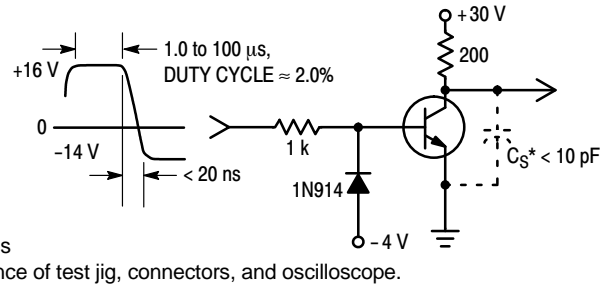

Figure 2. Turn-Off Time

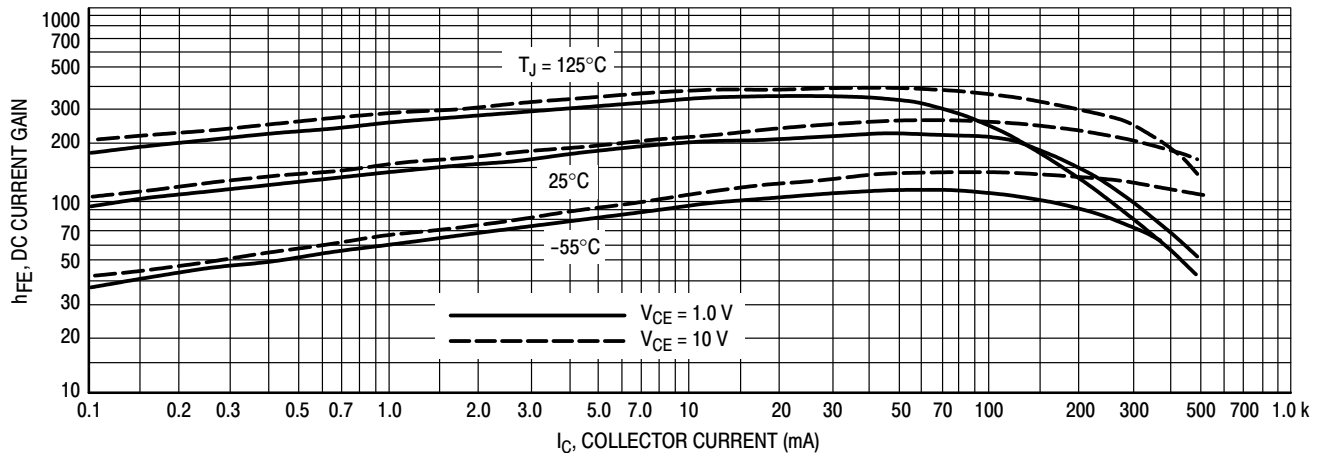

Figure 3. DC Current Gain

MMBT2222L, MMBT2222AL, SMMBT2222AL

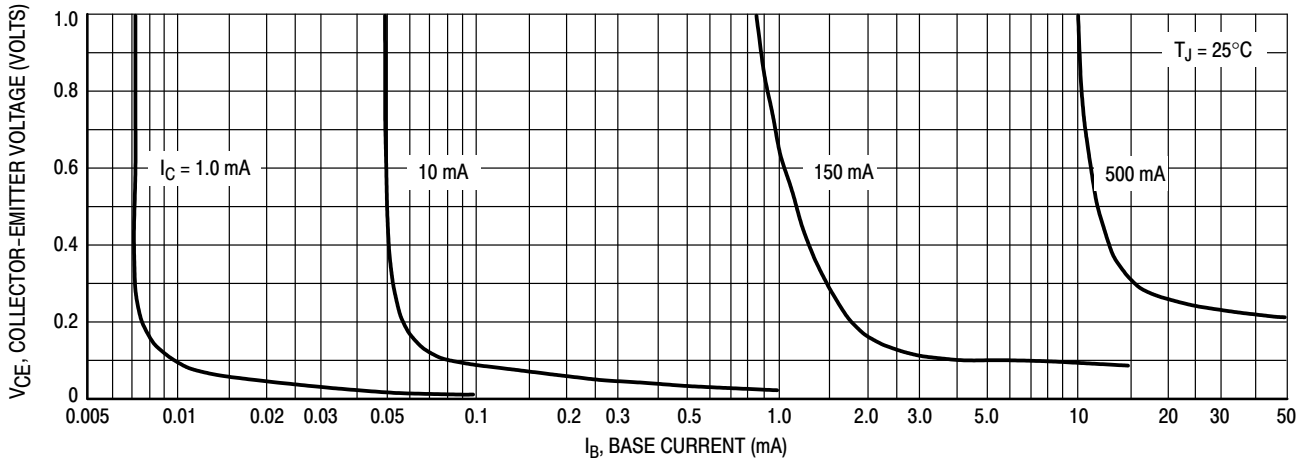

Figure 4. Collector Saturation Region

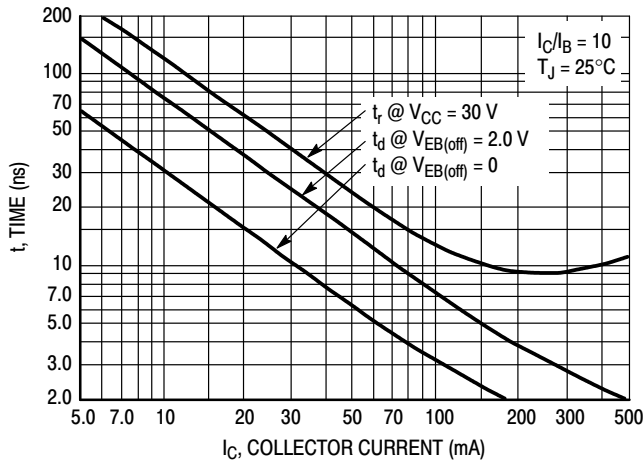

Figure 5. Turn-On Time

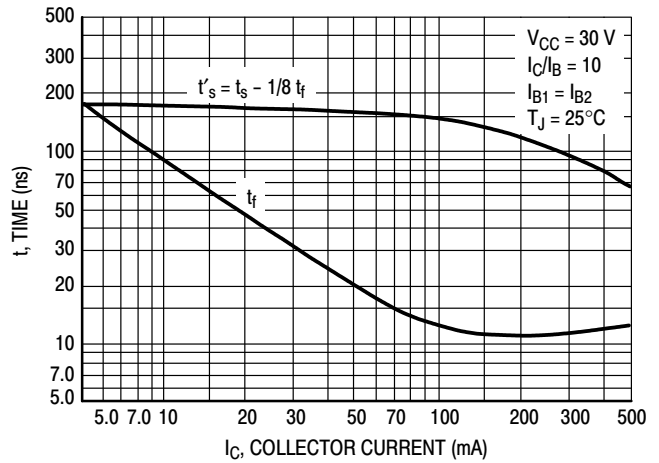

Figure 6. Turn-Off Time

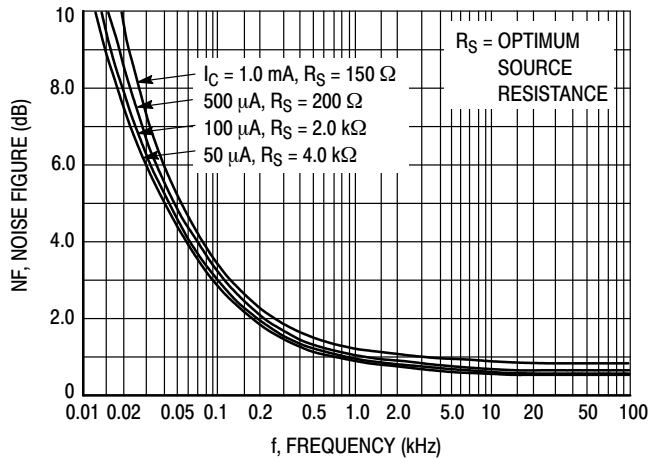

Figure 7. Frequency Effects

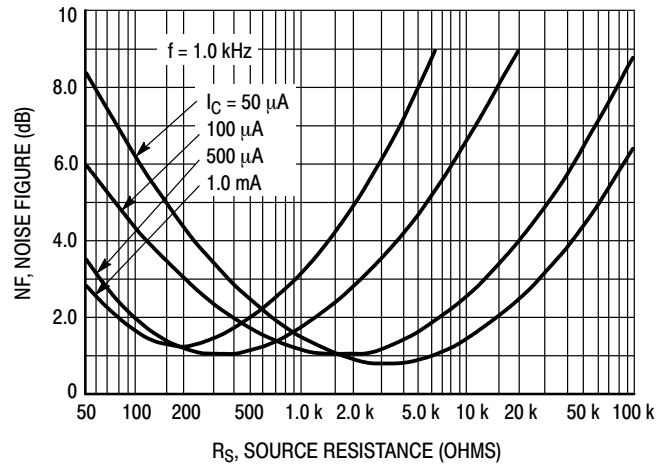

Figure 8. Source Resistance Effects

MMBT2222L, MMBT2222AL, SMMBT2222AL

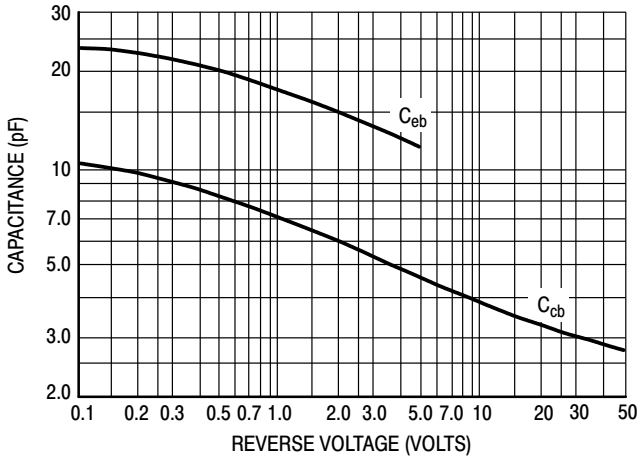

Figure 9. Capacitances

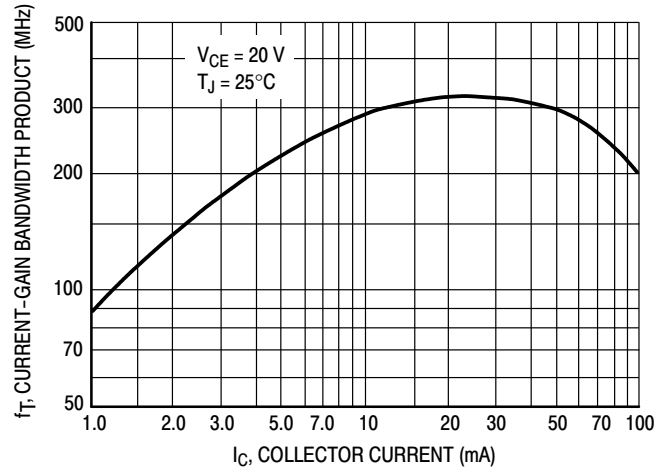

Figure 10. Current-Gain Bandwidth Product

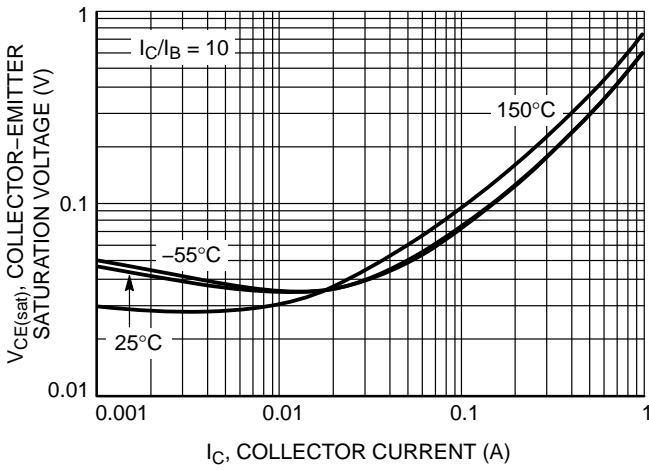

Figure 11. Collector-Emitter Saturation Voltage vs. Collector Current

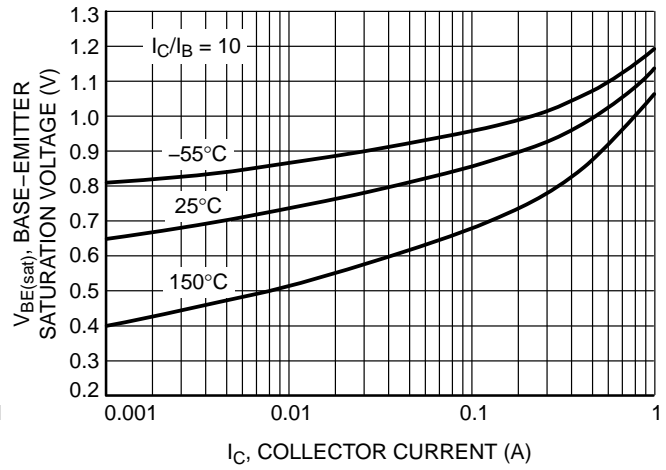

Figure 12. Base-Emitter Saturation Voltage vs. Collector Current

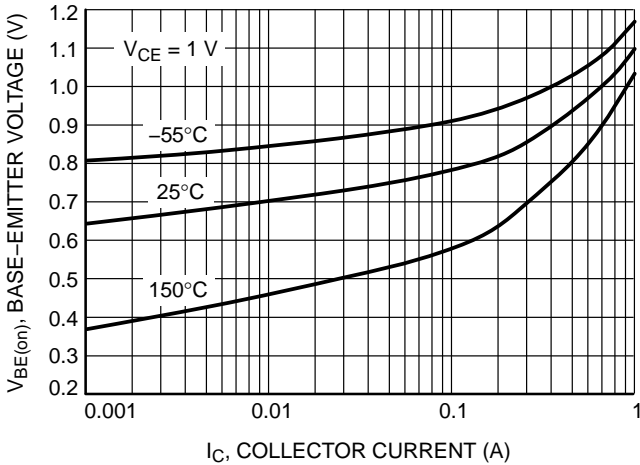

Figure 13. Base-Emitter Voltage vs. Collector Current

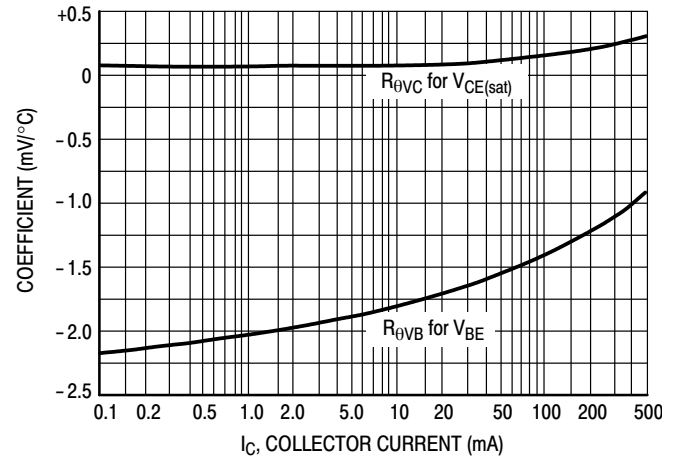

Figure 14. Temperature Coefficients

MMBT2222L, MMBT2222AL, SMMBT2222AL

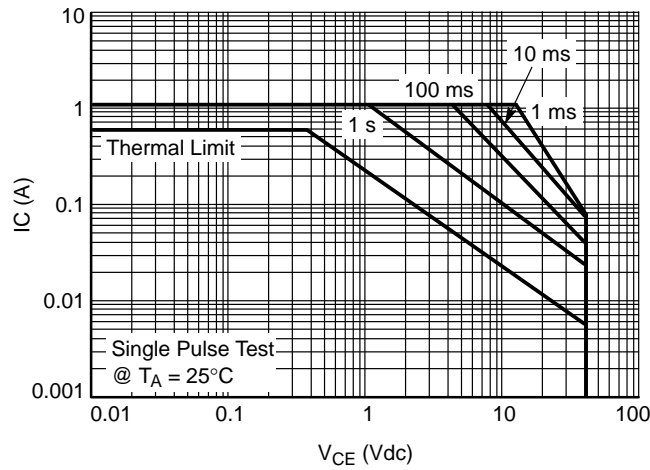

Figure 15. Safe Operating Area

ORDERING INFORMATION

Device	Specific Marking Code	Package	Shipping†
MMBT2222LT1G	M1B	SOT-23 (Pb-Free)	3000 / Tape & Reel
MMBT2222ALT1G, SMMBT2222ALT1G	1P	SOT-23 (Pb-Free)	3000 / Tape & Reel
MMBT2222LT3G	M1B	SOT-23 (Pb-Free)	10,000 / Tape & Reel
MMBT2222ALT3G, SMMBT2222ALT3G	1P	SOT-23 (Pb-Free)	10,000 / Tape & Reel

†For information on tape and reel specifications, including part orientation and tape sizes, please refer to our Tape and Reel Packaging Specifications Brochure, BRD8011/D.

*S Prefix for Automotive and Other Applications Requiring Unique Site and Control Change Requirements; AEC-Q101 Qualified and PPAP Capable.

MECHANICAL CASE OUTLINE

PACKAGE DIMENSIONS

ON Semiconductor®

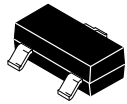

SOT-23 (TO-236)
CASE 318-08
ISSUE AS

DATE 30 JAN 2018

SCALE 4:1

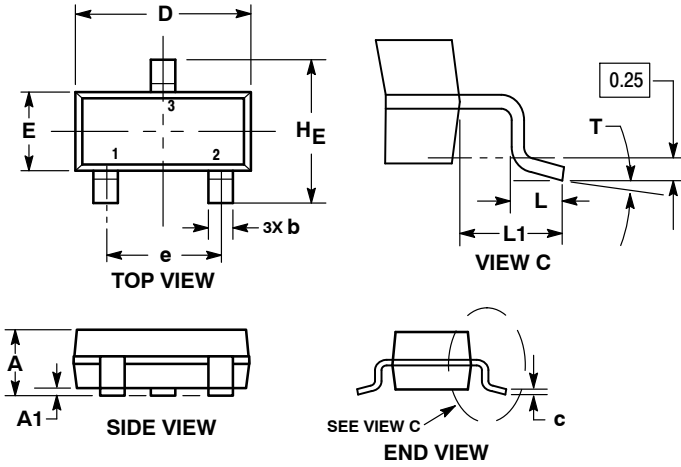

NOTES:

1. DIMENSIONING AND TOLERANCING PER ASME Y14.5M, 1994.
2. CONTROLLING DIMENSION: MILLIMETERS.
3. MAXIMUM LEAD THICKNESS INCLUDES LEAD FINISH. MINIMUM LEAD THICKNESS IS THE MINIMUM THICKNESS OF THE BASE MATERIAL.
4. DIMENSIONS D AND E DO NOT INCLUDE MOLD FLASH, PROTRUSIONS, OR GATE BURRS.

DIM	MILLIMETERS			INCHES		
	MIN	NOM	MAX	MIN	NOM	MAX
A	0.89	1.00	1.11	0.035	0.039	0.044
A1	0.01	0.06	0.10	0.000	0.002	0.004
b	0.37	0.44	0.50	0.015	0.017	0.020
c	0.08	0.14	0.20	0.003	0.006	0.008
D	2.80	2.90	3.04	0.110	0.114	0.120
E	1.20	1.30	1.40	0.047	0.051	0.055
e	1.78	1.90	2.04	0.070	0.075	0.080
L	0.30	0.43	0.55	0.012	0.017	0.022
L1	0.35	0.54	0.69	0.014	0.021	0.027
HE	2.10	2.40	2.64	0.083	0.094	0.104
T	0°	---	10°	0°	---	10°

RECOMMENDED SOLDERING FOOTPRINT

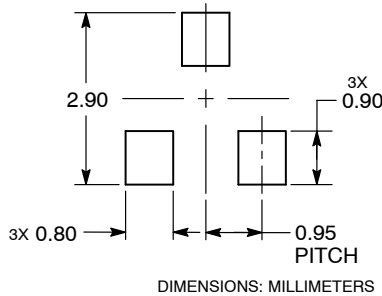

GENERIC MARKING DIAGRAM*



XXX = Specific Device Code
M = Date Code
▪ = Pb-Free Package

*This information is generic. Please refer to device data sheet for actual part marking. Pb-Free indicator, "G" or microdot "▪", may or may not be present.

STYLE 1 THRU 5:
CANCELLED

STYLE 6:
PIN 1. BASE
2. EMITTER
3. COLLECTOR

STYLE 7:
PIN 1. EMITTER
2. BASE
3. COLLECTOR

STYLE 8:
PIN 1. ANODE
2. NO CONNECTION
3. CATHODE

STYLE 9:
PIN 1. ANODE
2. ANODE
3. CATHODE

STYLE 10:
PIN 1. DRAIN
2. SOURCE
3. GATE

STYLE 11:
PIN 1. ANODE
2. CATHODE
3. CATHODE-ANODE

STYLE 12:
PIN 1. CATHODE
2. CATHODE
3. ANODE

STYLE 13:
PIN 1. SOURCE
2. DRAIN
3. GATE

STYLE 14:
PIN 1. CATHODE
2. GATE
3. ANODE

STYLE 15:
PIN 1. GATE
2. CATHODE
3. ANODE

STYLE 16:
PIN 1. ANODE
2. CATHODE
3. CATHODE

STYLE 17:
PIN 1. NO CONNECTION
2. ANODE
3. CATHODE

STYLE 18:
PIN 1. NO CONNECTION
2. CATHODE
3. ANODE

STYLE 19:
PIN 1. CATHODE
2. ANODE
3. CATHODE-ANODE

STYLE 20:
PIN 1. CATHODE
2. ANODE
3. GATE

STYLE 21:
PIN 1. GATE
2. SOURCE
3. DRAIN

STYLE 22:
PIN 1. RETURN
2. OUTPUT
3. INPUT

STYLE 23:
PIN 1. ANODE
2. ANODE
3. CATHODE

STYLE 24:
PIN 1. GATE
2. DRAIN
3. SOURCE

STYLE 25:
PIN 1. ANODE
2. CATHODE
3. GATE

STYLE 26:
PIN 1. CATHODE
2. ANODE
3. NO CONNECTION

STYLE 27:
PIN 1. CATHODE
2. CATHODE
3. CATHODE

STYLE 28:
PIN 1. ANODE
2. ANODE
3. ANODE

DOCUMENT NUMBER:	98ASB42226B	Electronic versions are uncontrolled except when accessed directly from the Document Repository. Printed versions are uncontrolled except when stamped "CONTROLLED COPY" in red.
DESCRIPTION:	SOT-23 (TO-236)	PAGE 1 OF 1

ON Semiconductor and ON are trademarks of Semiconductor Components Industries, LLC dba ON Semiconductor or its subsidiaries in the United States and/or other countries. ON Semiconductor reserves the right to make changes without further notice to any products herein. ON Semiconductor makes no warranty, representation or guarantee regarding the suitability of its products for any particular purpose, nor does ON Semiconductor assume any liability arising out of the application or use of any product or circuit, and specifically disclaims any and all liability, including without limitation special, consequential or incidental damages. ON Semiconductor does not convey any license under its patent rights nor the rights of others.

onsemi, **Onsemi**, and other names, marks, and brands are registered and/or common law trademarks of Semiconductor Components Industries, LLC dba "**onsemi**" or its affiliates and/or subsidiaries in the United States and/or other countries. **onsemi** owns the rights to a number of patents, trademarks, copyrights, trade secrets, and other intellectual property. A listing of **onsemi**'s product/patent coverage may be accessed at www.onsemi.com/site/pdf/Patent-Marking.pdf. **onsemi** reserves the right to make changes at any time to any products or information herein, without notice. The information herein is provided "as-is" and **onsemi** makes no warranty, representation or guarantee regarding the accuracy of the information, product features, availability, functionality, or suitability of its products for any particular purpose, nor does **onsemi** assume any liability arising out of the application or use of any product or circuit, and specifically disclaims any and all liability, including without limitation special, consequential or incidental damages. Buyer is responsible for its products and applications using **onsemi** products, including compliance with all laws, regulations and safety requirements or standards, regardless of any support or applications information provided by **onsemi**. "Typical" parameters which may be provided in **onsemi** data sheets and/or specifications can and do vary in different applications and actual performance may vary over time. All operating parameters, including "Typicals" must be validated for each customer application by customer's technical experts. **onsemi** does not convey any license under any of its intellectual property rights nor the rights of others. **onsemi** products are not designed, intended, or authorized for use as a critical component in life support systems or any FDA Class 3 medical devices or medical devices with a same or similar classification in a foreign jurisdiction or any devices intended for implantation in the human body. Should Buyer purchase or use **onsemi** products for any such unintended or unauthorized application, Buyer shall indemnify and hold **onsemi** and its officers, employees, subsidiaries, affiliates, and distributors harmless against all claims, costs, damages, and expenses, and reasonable attorney fees arising out of, directly or indirectly, any claim of personal injury or death associated with such unintended or unauthorized use, even if such claim alleges that **onsemi** was negligent regarding the design or manufacture of the part. **onsemi** is an Equal Opportunity/Affirmative Action Employer. This literature is subject to all applicable copyright laws and is not for resale in any manner.

PUBLICATION ORDERING INFORMATION

LITERATURE FULFILLMENT:

Email Requests to: orderlit@onsemi.com

onsemi Website: www.onsemi.com

TECHNICAL SUPPORT

North American Technical Support:

Voice Mail: 1 800-282-9855 Toll Free USA/Canada

Phone: 011 421 33 790 2910

Europe, Middle East and Africa Technical Support:

Phone: 00421 33 790 2910

For additional information, please contact your local Sales Representative

Mouser Electronics

Authorized Distributor

Click to View Pricing, Inventory, Delivery & Lifecycle Information:

[onsemi:](#)

[MMBT2222ALT1](#) [MMBT2222ALT1G](#) [MMBT2222ALT3](#) [MMBT2222LT1](#) [MMBT2222LT1G](#) [MMBT2222LT3](#)
[MMBT2222LT3G](#) [MMBT2222ALT3G](#) [SMMBT2222ALT3G](#) [SMMBT2222ALT1G](#)