

## MAX16550A MAX16550B

## Integrated Protection IC on 12V Bus with an Integrated MOSFET, Lossless Current Sensing, and PMBus Interface

### General Description

The MAX16550A/MAX16550B are protection ICs with an integrated low-resistance MOSFET and lossless current-sense circuitry featuring SMBus/PMBus™ control and reporting. The ICs are designed to provide the optimum solution for distribution, control, monitoring and protection of the system's 12V power supply. An internal LDO provides the supply voltage for the protection IC.

If no fault is detected, the ICs initiate the startup and have been designed to provide controlled, monotonic startup. Programmable soft-start ramp and delay is implemented to limit the in-rush current during startup.

The ICs monitor the current and voltage of the 12V system power rail and provide multiple levels of protection with fast turn-off if a fault is detected.

Maxim's patented, lossless current sense provides high accuracy current sensing over load and temperature, improving overall system-energy efficiency, and reducing dissipation.

If, at any time, the output voltage falls below the programmable output undervoltage-lockout threshold, the PWRGD signal is asserted low. If at any time the input voltage falls below the programmable input undervoltage-lockout threshold, the PWRGD signal is asserted low.

See the [Basic Application Circuit](#) utilizing the MAX16550A/MAX16550B ICs.

### Systems and Applications

Servers, Networking, Storage, Communication Equipment and AC/DC Power Supplies

- Integrated Protection IC on 12V
  - Circuit Breaker/E-Fuse, Hot Swap

[Ordering Information](#) appears at end of data sheet.

### Benefits and Features

- Three Options:
  - MAX16550A: 30A Protection with 8A Startup
  - MAX16550B: 30A Protection with 16A Startup
- High-Density (4mm x 4.5mm for 30A): Less than 25% of the Board Area of Conventional Solutions
  - Monolithic Integration of Power, Control, and Monitoring
  - Integrated Power MOSFET with 1.9mΩ Total Resistance in 12V Power Path ( $R_{DS(ON)}$  Including Package)
  - Integrated Lossless, Precise Current Sensing
  - Integrated LDO Provides  $V_{DD}$  Supply (1.8V Bias Supply)
- Enables Advanced System Power Management—PMBus/SMBus Telemetry with Extensive Status Monitoring and Reporting
  - Load Current Indicator (ILOAD) Pin Provides Analog Output Current Reporting with High Accuracy
  - Programmable Soft-Start for Inrush Current Limiting
  - Increases Power-Supply Reliability with IC Self-Protection Features
    - Very Fast Fault Detection and Isolation
    - $V_{IN}$  to  $V_{OUT}$  Short Protection During Startup
    - Overtemperature Protection
  - Three Levels of Overcurrent Protection
    - Programmable Moderate OCP
    - Programmable Severe OCP Provides Isolation < 5μs
    - Fail-Safe Safe OCP Provides Isolation < 250ns

### Additional Features

- Programmable Soft-Start and Delay
- Programmable Input Undervoltage-Lockout Threshold (UVLO)
- Programmable Power-Good Threshold
- PWRGD Pin for Output UVLO/Input UVLO Reporting
- FAULT Pin for Fault Reporting

PMBus is a trademark of SMIF, Inc.

MAX16550A  
MAX16550B

Integrated Protection IC on 12V Bus with an  
Integrated MOSFET, Lossless Current Sensing,  
and PMBus Interface

### Basic Application Circuit

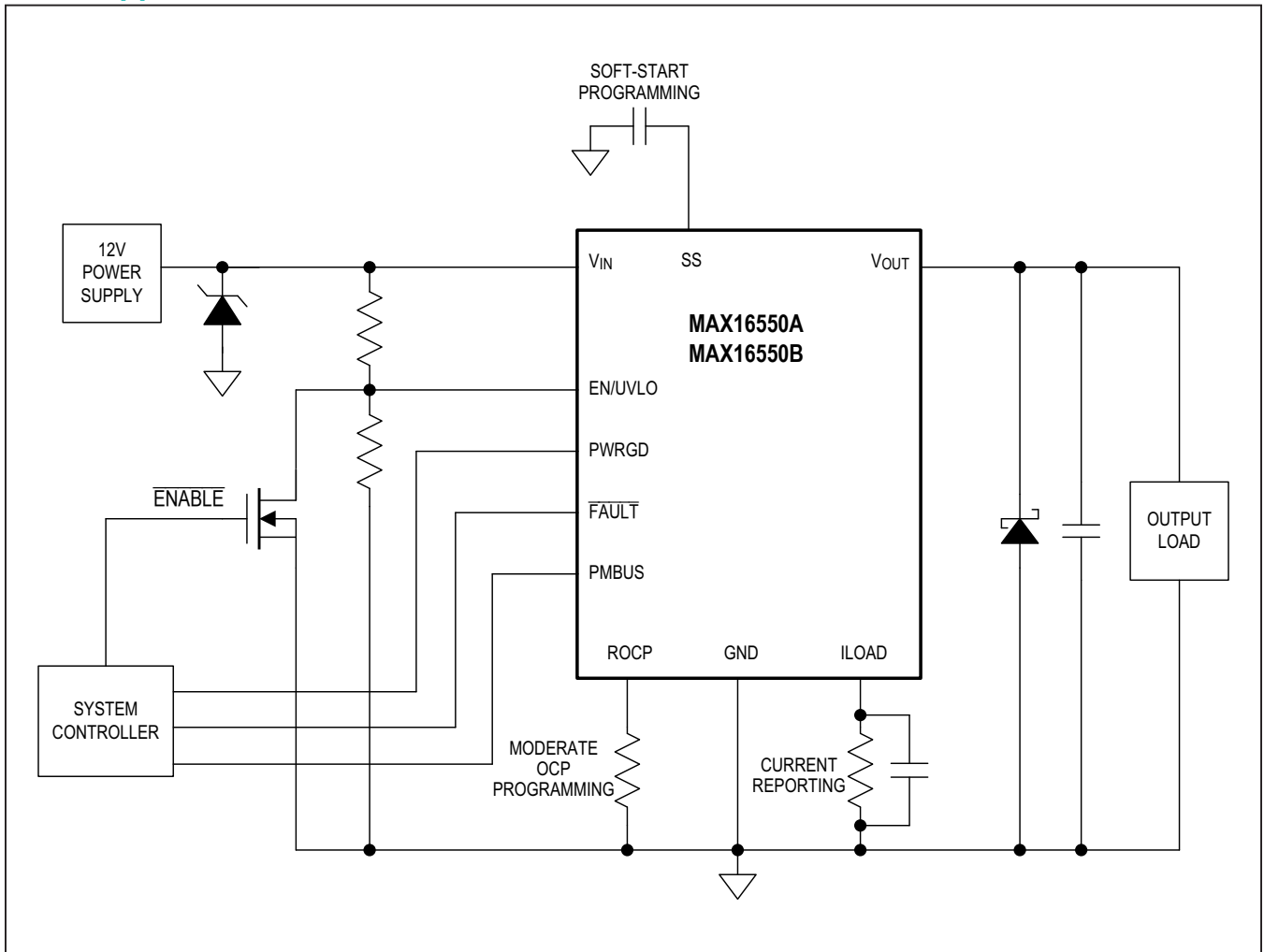

MAX16550A  
MAX16550B

Integrated Protection IC on 12V Bus with an  
Integrated MOSFET, Lossless Current Sensing,  
and PMBus Interface

**Absolute Maximum Ratings (Note 1)**

Supply Voltage (V <sub>IN</sub> ) DC .....	-0.3V to +16V	ILOAD .....	-0.3V to +2.5V
Supply Voltage (V <sub>IN</sub> ) 150µs .....	22V	Output Voltage (V <sub>OUT</sub> ) DC .....	-0.3V to +16V
Bias Supply Voltage (V <sub>DD</sub> ) .....	-0.3V to +2.5V	BST (Relative to V <sub>OUT</sub> ) .....	-0.3V to +2.5V
PWRGD, FAULT .....	-0.3V to +5.5V	SS .....	-0.3V to +16V
EN/UVLO, R <sub>OCP</sub> .....	-0.3V to +2.5V	Junction Temperature (T <sub>J</sub> ) .....	150°C
SMBUS_CLK, SMBUS_DATA, SMBUS_ALERT .....	6V	Storage Temperature Range .....	-65°C to +165°C
SMBUS_ID .....	-0.3V to +2.5V	Peak Reflow Temperature .....	260°C

Stresses beyond those listed under “Absolute Maximum Ratings” may cause permanent damage to the device. These are stress ratings only; functional operation of the device at these or any other conditions beyond those indicated in the operational sections of the specifications is not implied. Exposure to absolute maximum rating conditions for extended periods may affect device reliability.

**Operating Ratings**

Supply Voltage (V <sub>IN</sub> ) .....	10.8V to 13.2V	Junction Temperature (T <sub>J</sub> ) .....	0°C to +125°C
Bias Supply Voltage (V <sub>DD</sub> ) .....	1.76V to 1.94V		

**Package Information**

<b>PACKAGE TYPE: 18 FCQFN</b>	
Package Code	P184A4F+1
Outline Number	<a href="#">21-1080</a>
Land Pattern Number	<a href="#">90-0529</a>
<b>THERMAL RESISTANCE</b>	
Junction to Case (θ <sub>JC</sub> )	0.31°C/W

For the latest package outline information and land patterns (footprints), go to [www.maximintegrated.com/packages](http://www.maximintegrated.com/packages). Note that a “+”, “#”, or “-” in the package code indicates RoHS status only. Package drawings may show a different suffix character, but the drawing pertains to the package regardless of RoHS status.

**Electrical Characteristics**

(V<sub>IN</sub> = 12V ±10%, unless otherwise noted. T<sub>J</sub> = 0 to +125°C, unless otherwise noted. Specifications are 100% production tested at T<sub>A</sub> = +32°C. Limits over operating temperature range are guaranteed by design and characterization.)

PARAMETER	SYMBOL	CONDITIONS	MIN	TYP	MAX	UNITS
<b>12V SUPPLY (V<sub>IN</sub>)</b>						
Supply Voltage Range	V <sub>IN</sub>		10.8	12	13.2	V
Device Supply Current	I <sub>IN</sub>	FET off	3.0		6.25	mA
		FET on: I <sub>OUT</sub> = 0 (Note 1)	3.7		6.75	
		FET on: I <sub>OUT</sub> = 30A (Note 1)			10	
<b>INTEGRATED 1.8V LINEAR REGULATOR</b>						
LDO Output Voltage Range	V <sub>DD</sub>		1.76	1.85	1.94	V
V <sub>DD</sub> Falling		(Note 1)	1.55	1.6	1.7	
V <sub>DD</sub> Rising		(Note 1)	1.62	1.67	1.73	
Hysteresis		(Note 1)	30	60	80	
V <sub>DD</sub> UVLO Response Time		(Note 1)			2	µs

MAX16550A  
MAX16550B

Integrated Protection IC on 12V Bus with an  
Integrated MOSFET, Lossless Current Sensing,  
and PMBus Interface

Electrical Characteristics (continued)

( $V_{IN} = 12V \pm 10\%$ , unless otherwise noted.  $T_J = 0$  to  $+125^\circ C$ , unless otherwise noted. Specifications are 100% production tested at  $T_A = +32^\circ C$ . Limits over operating temperature range are guaranteed by design and characterization.)

PARAMETER	SYMBOL	CONDITIONS	MIN	TYP	MAX	UNITS
<b>UNDERVOLTAGE LOCKOUT: 12V SUPPLY (<math>V_{IN}</math>)</b>						
$V_{IN\_UVLO}$ Rising Threshold	$V_{IN\_UVLO}$	At EN/UVLO pin	0.95	1	1.05	V
$V_{IN\_UVLO}$ Hysteresis				50		mV
Programmable 12V $V_{IN}$ Undervoltage Threshold for Rising Input	$V_{IN\_UVLO}$	Programmable through resistor-divider, measured at $V_{IN}$	8			V
Response Time	$t_D$	From EN/UVLO = 0V to FET off		2		$\mu s$
<b>EN_UVLO PIN INTERNAL PARAMETERS</b>						
EN_UVLO Pin Leakage		EN_UVLO = 1.8V	5	6.7	11	$\mu A$
EN_UVLO Internal Pulldown Resistor			110	250	450	k $\Omega$
<b>BOOST VOLTAGE (<math>V_{BST}</math>)</b>						
$V_{BST}$ Charging Time to 1.6V Above $V_{OUT}$	$t_{CHARGE}$	$C_{BST} = 100nF$		150		$\mu s$
BST Voltage Above $V_{OUT}$	$V_{BST}$			1.8		V
Rising UVLO Threshold Above $V_{OUT}$	BOOST UVLO	(Note 1)	0.8	1.2	1.6	V
Falling UVLO Threshold Above $V_{OUT}$		(Note 1)	0.74	1.1	1.5	
UVLO Hysteresis		(Note 1)	60	130	400	mV
Falling Lockout Response Time	$t_D$			1.5		$\mu s$
<b>INTEGRATED MOSFET CHARACTERISTICS</b>						
On-Resistance	$R_{DS(ON)}$	(Note 1)		1.9		m $\Omega$
<b>COMMON OVERCURRENT PROTECTION (OCP)</b>						
Severe OCP Threshold Scale Factor	OCP_CFG	Digitally programmable		1.3		
Severe OCP Threshold Accuracy				$\pm 20$		%
Severe OCP Delay	$t_D(SEVERE)$	From fault threshold exceeded to FET off (Note 3)		5		$\mu s$
Gain from ROCP Pin Current	$G_{OCP}$	(Note 1)		4		A/ $\mu A$
Allowed Range for No-Fault Detection	ROCP		28		360	k $\Omega$
Startup OCP Threshold	$I_{OCP\_STARTUP}$	MAX16550A (Note 1)		8		A
		MAX16550B (Note 1)			16	
Startup OCP Threshold Accuracy		$I_{OUT} = 8A$ (Note 1)		$\pm 20$		%
Safe OCP Threshold	$I_{OCP\_SAFE}$	(Note 1)		60		A
Safe OCP Threshold Accuracy		$V_{IN} = 12V, T = +125^\circ C$			$\pm 20$	
Safe OCP Delay	$t_D\_SAFE$	From fault threshold exceeded to FET off		250		ns

MAX16550A  
MAX16550B

Integrated Protection IC on 12V Bus with an  
Integrated MOSFET, Lossless Current Sensing,  
and PMBus Interface

Electrical Characteristics (continued)

( $V_{IN} = 12V \pm 10\%$ , unless otherwise noted.  $T_J = 0$  to  $+125^\circ C$ , unless otherwise noted. Specifications are 100% production tested at  $T_A = +32^\circ C$ . Limits over operating temperature range are guaranteed by design and characterization.)

PARAMETER	SYMBOL	CONDITIONS	MIN	TYP	MAX	UNITS	
<b>OVERCURRENT PROTECTION (OCP) (MAX16550A/MAX16550B)</b>							
Gain from ROCP Pin Current	$G_{OCP}$	Gain from ROCP pin current to $I_{OUT}$ (Note 1)		4		A/ $\mu$ A	
Moderate OCP Voltage Threshold	$V_{OCPM}$	Referred to voltage over ROCP (Note 1)		0.8		V	
Moderate OCP Voltage Threshold Accuracy		Referred to $I_{OUT}$ using Equation 1		$\pm 12$		%	
Moderate OCP Threshold Range	$I_{OCP(MODERATE)}$	Analog programmable through ROCP	15		35	A	
Allowable ROCP Range for ROCP_Fault Detection at Power-Up	ROCP		28		360	k $\Omega$	
Moderate OCP Timeout	$t_{OCPM}$	$I_{OUT} >$ moderate OCP, $I_{OUT} <$ severe OCP, programmable default moderate OCP timeout = 100 $\mu$ s (Note 2)		12.5		$\mu$ s	
				100		$\mu$ s	
				100		ms	
				250		ms	
Moderate OCP Fault-Detect Delay Timeout Accuracy		(Note 2)		$\pm 10$		%	
<b>SOFT-START AND <math>C_{OUT}</math></b>							
Soft-Start Discharge Resistance	SS			1	2	k $\Omega$	
Soft-Start Charging Current	$I_{SS}$		20		39	$\mu$ A	
Soft-Start Capacitor Value Range	$C_{SS}$	Linear startup ramp	0		75	nF	
Soft-Start Time	$t_{SS}$	$C_{SS} = 0nF, I_{OUT} = 0A$ (Note 2)		1		ms	
Soft-Start Capacitor Discharge Threshold			0.17	0.2	0.25	V	
CSS Discharge Check Duration During Startup		(Note 2)		2.2		s	
<b>FET <math>V_{GS}</math> UNDERVOLTAGE LOCKOUT</b>							
$V_{GS}$ Rising UVLO Threshold	$V_{GS\_UVLO}$		0.87	1.3	1.61	V	
$V_{GS}$ Falling UVLO Threshold			0.74	1.17	1.50		
$V_{GS}$ UVLO Hysteresis			87	100	466	mV	
$V_{GS}$ UVLO Masking Time			During startup (Note 2)		100		ms
$V_{GS}$ UVLO Deglitching			(Note 2)		10		$\mu$ s
<b>PASS FET SHORT DETECTION DURING STARTUP</b>							
Duration of $V_{OUT}$ Discharge Check	$t_{DISCHARGE}$	(Note 2)		2.2		s	
Pulldown Resistance on $V_{OUT}$ During Self-Check	$R_{DISCHARGE}$		400	455	560	$\Omega$	
Threshold for Self-Check Procedure	$V_{OUT\_SELF\_CHECK}$	SMBus/PMBus programmable, default 9V (Note 1)	5.8	6	6.2	V	
			6.8	7	7.2		
			7.7	8	8.2		
			8.8	9	9.4		
Delay before Self-Check	$t_D$	Programmable (Note 2)		2.5		ms	
				12.5			
				22.6			

MAX16550A  
MAX16550B

Integrated Protection IC on 12V Bus with an  
Integrated MOSFET, Lossless Current Sensing,  
and PMBus Interface

Electrical Characteristics (continued)

( $V_{IN} = 12V \pm 10\%$ , unless otherwise noted.  $T_J = 0$  to  $+125^\circ C$ , unless otherwise noted. Specifications are 100% production tested at  $T_A = +32^\circ C$ . Limits over operating temperature range are guaranteed by design and characterization.)

PARAMETER	SYMBOL	CONDITIONS	MIN	TYP	MAX	UNITS
<b>PWRGD PIN</b>						
Max Allowable PWRGD Output High Voltage	$V_{OH}$	External pullup leakage below $1\mu A$		5.5		V
PWRGD Output Low Voltage	$V_{OL}$	Sinking 4mA			0.4	V
Propagation Delay from $V_{OJT\_UVLO}$ Detect to PWRGD Pin Asserted Low	$t_D$	(Note 2)		3.2		$\mu s$
Threshold for PWRGD Asserted High	$V_{TH(PWRGD)}$	SMBus/PMBus programmable, default 11V (Note 1)		8 9 10 11		V
PWRGD Clear Timing Time Needed to Clear PWRGD after $V_{OJT}$ Has Reached $V_{IN}$		(Note 2)		5		ms
PWRGD Hysteresis		(Note 1)	0.35	0.5	0.63	V
PWRGD Accuracy			-5		+5	%
<b>OVERTEMPERATURE PROTECTION (OTP)</b>						
Overtemperature-Protection Threshold	$T_{OTP}$	PMBus programmable (Note 1)		140		$^\circ C$
<b>SMBus DATA (SMBUS_DATA) AND CLOCK (SMBUS_CLOCK) PINS</b>						
Leakage Current		For pullup = 5.5V (Note 1)		5.3		$\mu A$
Input Low Voltage	$V_{IL}$				0.8	V
Input High Voltage	$V_{IH}$		2.1			V
Output Low Voltage	$V_{OL}$	SMBUS_DATA, sinking 4mA			0.4	V
Max Allowable External Pullup Voltage	$V_{OH\ MAX}$			5.5		V
<b>SMBus ALERT PIN</b>						
Output Low Voltage	$V_{OL}$	Sinking 4mA			0.4	V
Leakage Current		For pullup = 5.5V (Note 1)			1	$\mu A$
Max Allowable External Pullup Voltage	$V_{OH\ MAX}$			5.5		V
<b>FAULT-ISOLATION DELAY</b>						
Fault-Detection Time	$t_D$	Fault detection to start of gate pulldown (Note 2)		60		ns
Pass FET Turn-Off Time	$t_F$	From start of gate pulldown to pass FET off (Note 2)		50		ns
<b>FAULT PIN</b>						
Input High Voltage	$V_{IH}$	(Note 1)	1			V
Input Low Voltage	$V_{IL}$	(Note 1)			0.66	V
Max Allowable $\overline{FAULT}$ Output High Voltage	$V_{OH}$	External pullup, leakage below $1\mu A$		5.5		V
$\overline{FAULT}$ Output Low Voltage	$V_{OL}$	Sinking 4mA			0.4	V
Propagation Delay from Fault Detect to $\overline{FAULT}$ Asserted Low	$t_D$	(Note 2)		100		ns

MAX16550A  
MAX16550B

Integrated Protection IC on 12V Bus with an  
Integrated MOSFET, Lossless Current Sensing,  
and PMBus Interface

Electrical Characteristics (continued)

( $V_{IN} = 12V \pm 10\%$ , unless otherwise noted.  $T_J = 0$  to  $+125^\circ C$ , unless otherwise noted. Specifications are 100% production tested at  $T_A = +32^\circ C$ . Limits over operating temperature range are guaranteed by design and characterization.)

PARAMETER	SYMBOL	CONDITIONS	MIN	TYP	MAX	UNITS
<b><math>V_{IN}</math> OVERVOLTAGE PROTECTION (OVP)</b>						
OVP Threshold	$V_{IN\_OVP}$	Measured at $V_{IN}$ . MAX16550A only		14.5		V
$V_{IN}$ Overvoltage Accuracy	$V_{IN\_OVP}$		-5		+5	%
Deglitching Time	$t_{FILTER\_OVP}$	(Note 2)		20		$\mu s$
<b>CURRENT REPORTING (ILOAD) PIN</b>						
Linear $I_{OUT}$ Reporting Range		Current-reporting range	0		30	A
Max Allowable Linear Voltage Range				1.35		V
Offset Current		$I_{OUT} = 0A$		0.32		$\mu A$
Current-Reporting Gain	$G_{ILOAD}$	ILOAD current divided by $I_{OUT}$ current (Note 1)		5		$\mu A/A$
Bandwidth		No capacitor in parallel with $R_{LOAD}$ resistor	100			kHz
<b>ANALOG CURRENT-REPORTING ACCURACY</b>						
Current-Reporting Accuracy (Notes 2, 3, 4)	$I_{OUT}$	$I_{OUT} = 4A$	-2.5		+2.5	%
		$I_{OUT} = 30A$	-1.8		+1.8	
<b>SMBus/PMBus TELEMETRY</b>						
Digital Current-Reporting Accuracy	READ_IOUT (8Ch), READ_IIN (89h)	$I_{OUT} = 4A$		$\pm 3$		%
		$I_{OUT} = 30A$		$\pm 2$		
Digital Power-Reporting Accuracy	READ_PIN (97h)	Digital, $I_{OUT} = 4A$ , $V_{IN} = 12V$ , $R_{LOAD} = 9k\Omega$		$\pm 5$		%
		Digital, $I_{OUT} = 30A$ , $V_{IN} = 12V$ , $R_{LOAD} = 9k\Omega$		$\pm 3.5$		
Digital Input-Voltage Reporting Accuracy	READ_VIN (88h)			$\pm 1.2$		%
Digital Output-Voltage Reporting Accuracy	READ_VOUT (8Bh)			$\pm 1.2$		%
Digital Temperature-Reporting Accuracy	READ_ TEMPERATURE_1 (8Dh)			$\pm 8$		$^\circ C$
Digital Energy-Reporting Accuracy	READ_EIN (86h)	$I_{OUT} = 4A$		$\pm 5$		%
		$I_{OUT} = 30A$		$\pm 3$		

**Note 1:** Denotes specification that applies for typical operating junction temperature ( $T_J = +25^\circ C$ ).

**Note 2:** Guaranteed by design, not production tested.

**Note 3:** Reporting accuracy presented includes 0.1% external resistor tolerance contribution.

**Note 4:** Min/max limits are  $\geq 4\sigma$  about the mean.

Typical Operating Characteristics

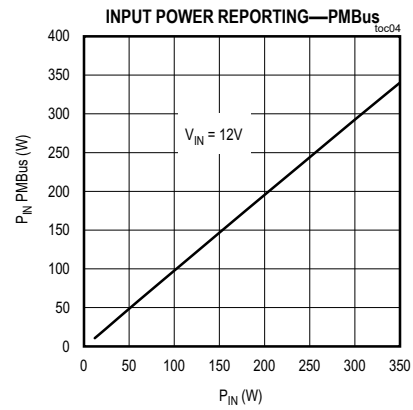
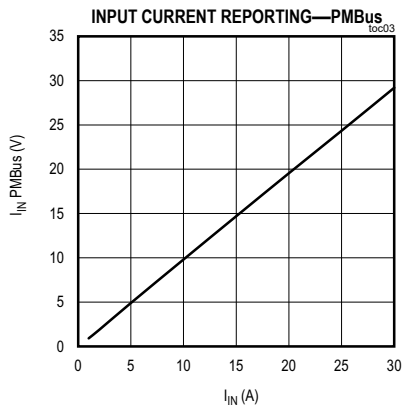
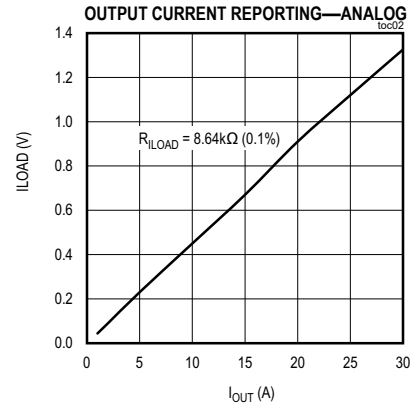
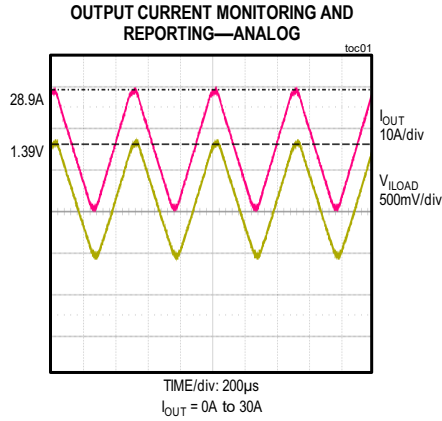



Typical Operating Characteristics (continued)

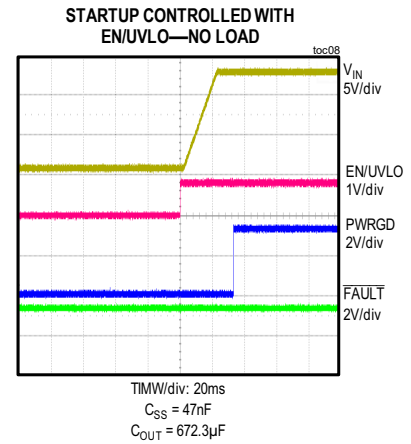
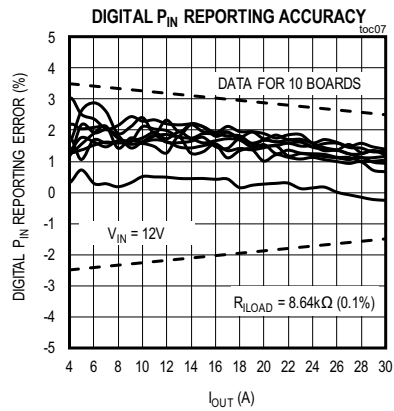
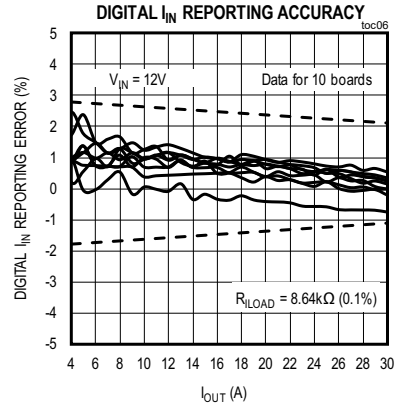
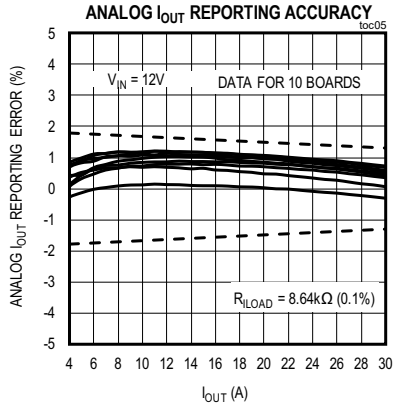

Typical Operating Characteristics (continued)

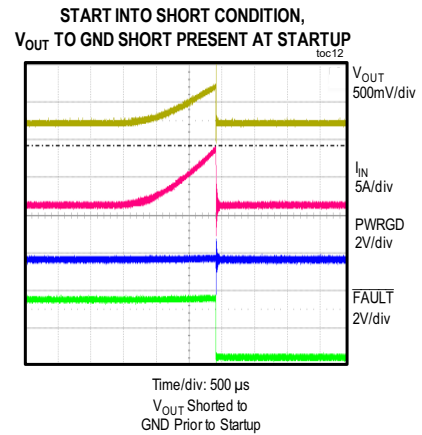
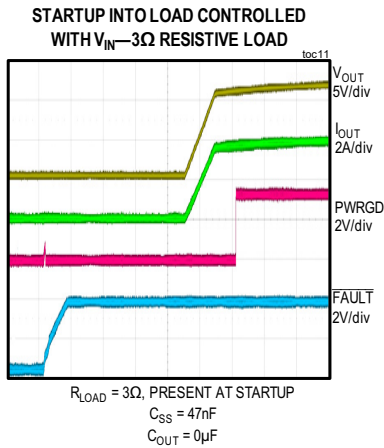
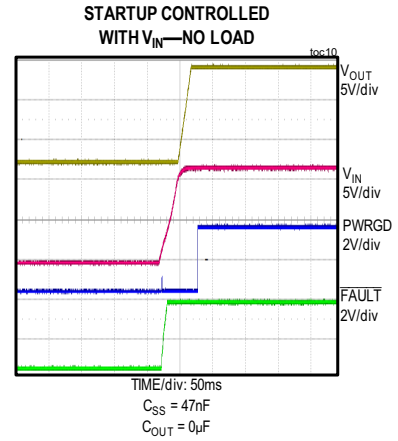
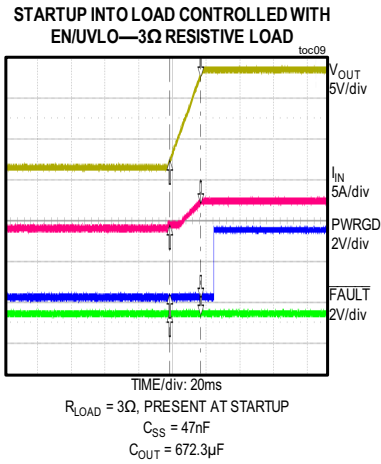

Typical Operating Characteristics (continued)

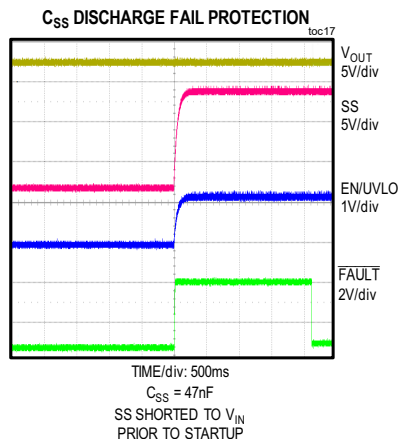
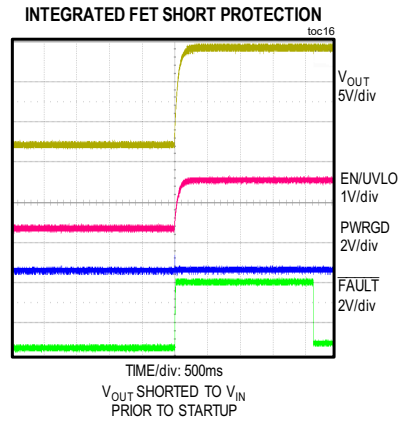
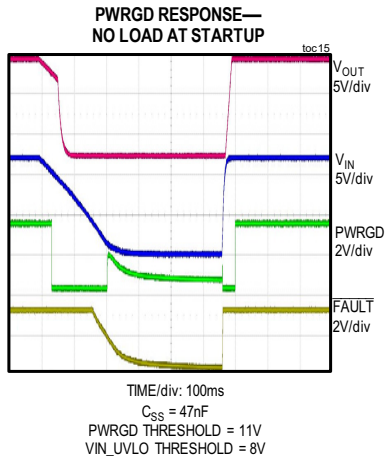
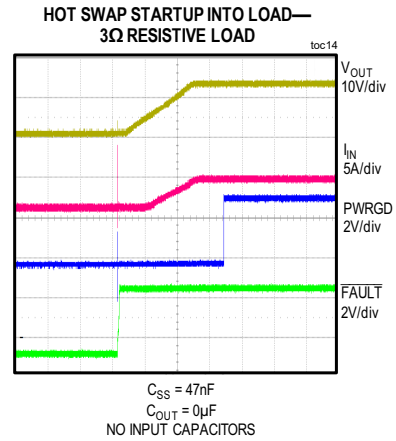
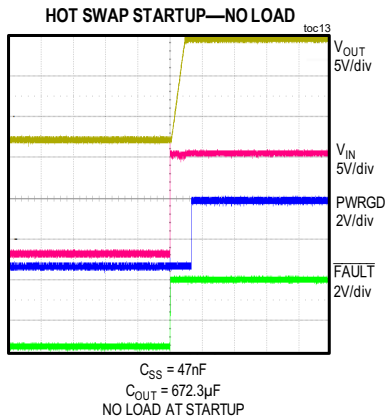

Typical Operating Characteristics (continued)

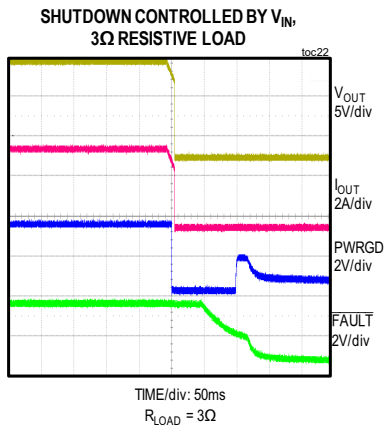
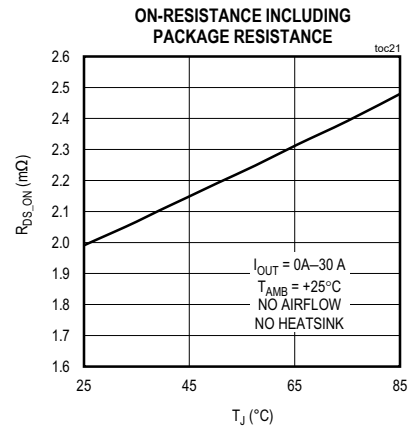
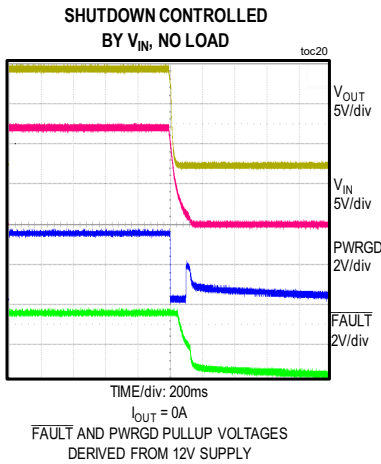
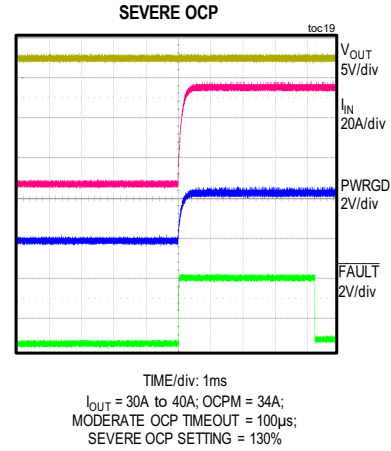
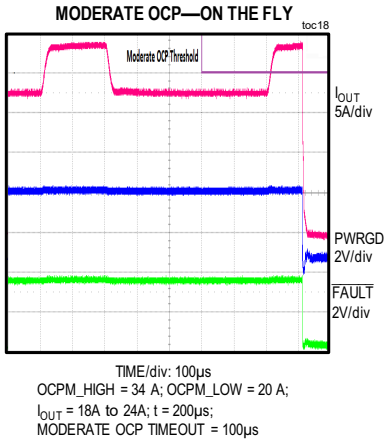

Typical Operating Characteristics (continued)

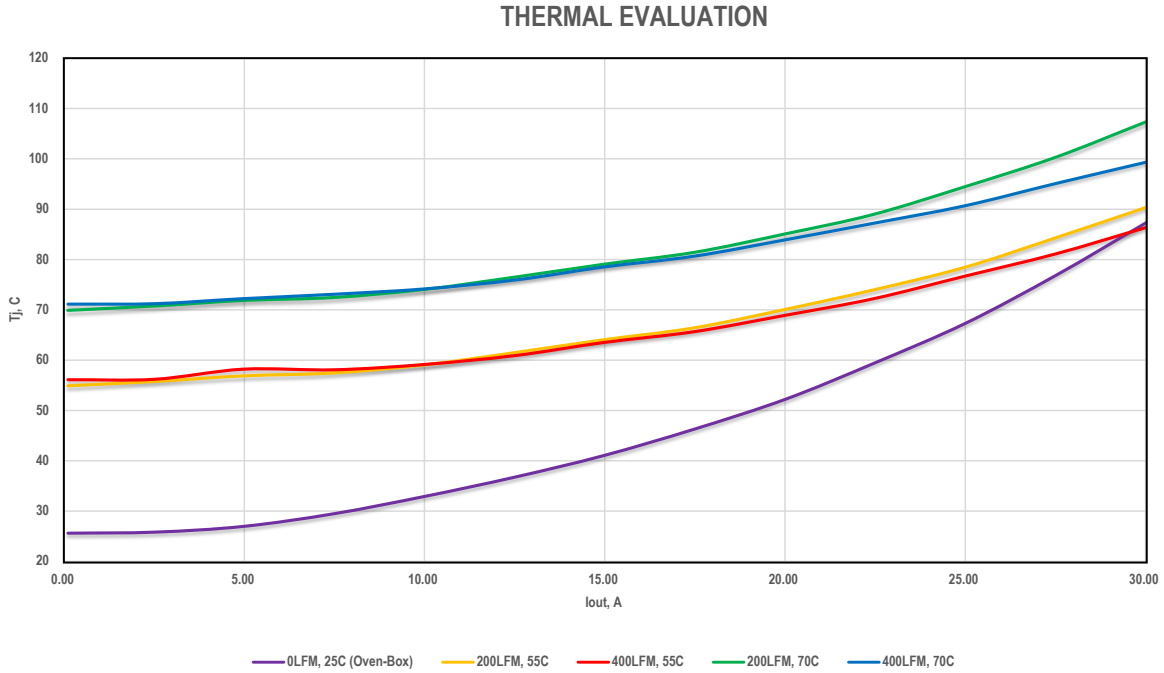

### Pin Configuration

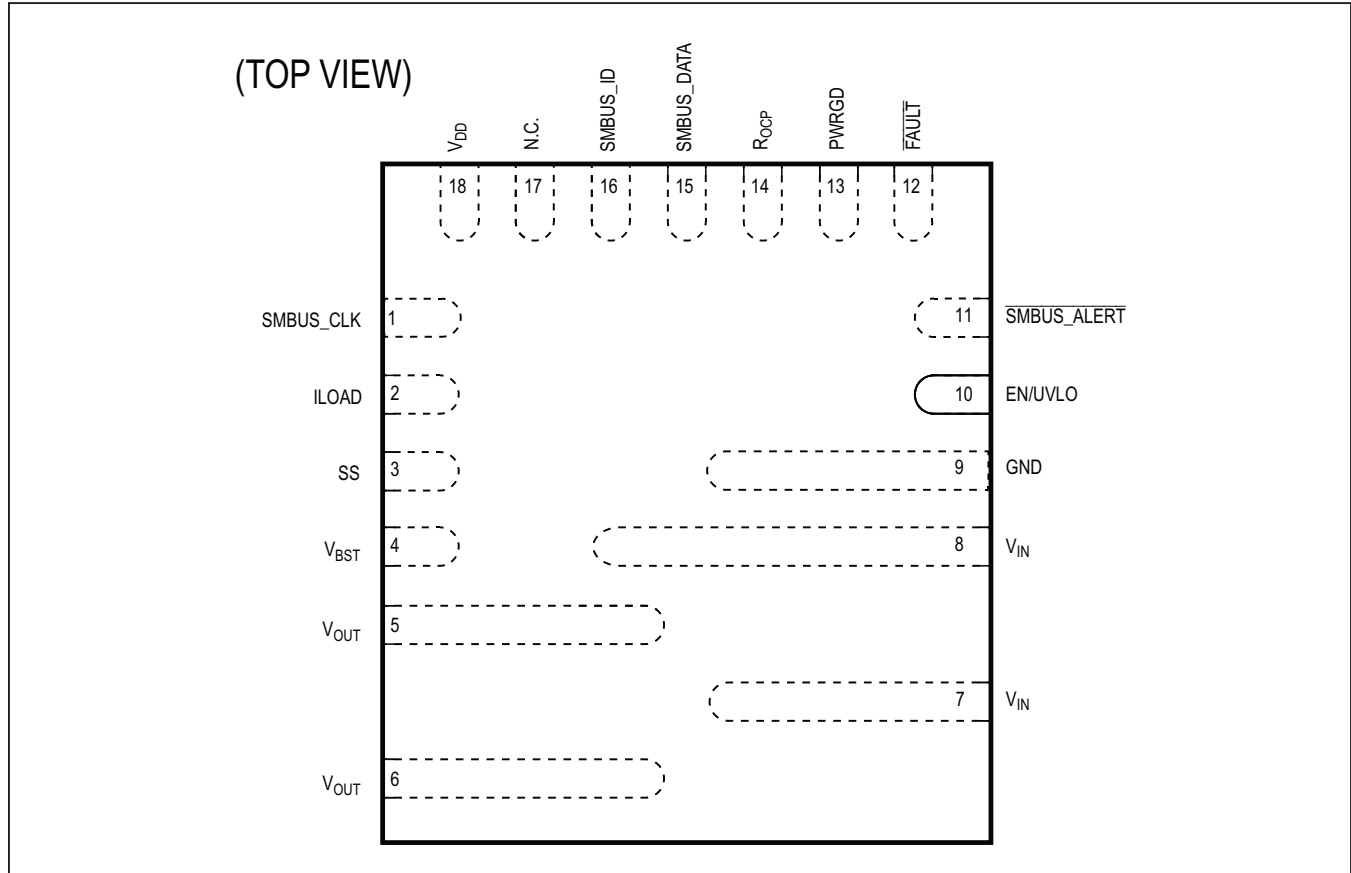

### Pin Description

PIN	NAME	FUNCTION
1	SMBUS_CLK	SMBus Clock Pin.
2	ILOAD	Analog Current Representation of the Load Current. Connect the pin to ground through a properly sized resistor for proper voltage representation. Always keep this pin connected to ground through a resistor. A capacitor parallel to the R <sub>ILOAD</sub> resistor is required; see Table 16 for the recommended value.
3	SS	Soft-Start Pin. A capacitor is connected from SS to GND to program soft-start. The soft-start program capacitor should not exceed 75nF. If a fast load transient (di/dt > 2.5A/ms) resulting in fast and large transient output-voltage deviation is possible in the application, an additional capacitor between SS and V <sub>OUT</sub> is recommended to keep the pass FET V <sub>GS</sub> above its UVLO threshold.
4	V <sub>BST</sub>	Charge-Pump Supply for Pass FET Gate Drive. Connect this node to V <sub>OUT</sub> through a 220nF bypass capacitor. This supply is designed to be used by the MAX16550A/MAX16550B only. No additional load or external components other than a bypass capacitor are allowed on the V <sub>BST</sub> pin.

MAX16550A  
MAX16550B

Integrated Protection IC on 12V Bus with an  
Integrated MOSFET, Lossless Current Sensing,  
and PMBus Interface

Pin Description (continued)

PIN	NAME	FUNCTION
5-6	$V_{OUT}$	12V Output Power Pins (Load Side).
7-8	$V_{IN}$	12V Input Power Pins (Power Supply Side).
9	GND	IC Ground. Connect this node to GND plane through vias for proper operation.
10	EN/UVLO	12V Input Voltage and UVLO Pin. Normally connected to the center node of a resistor-divider connected from $V_{IN}$ to ground. A properly sized capacitor can be placed in parallel to the bottom resistor of the resistor-divider for additional filtering. In addition to 12V UVLO programming, this node can be used to enable/disable the MAX16550A / MAX16550B.
11	SMBUS_ALERT	SMBus Alert, Open-Drain, Active-Low Pin.
12	$\overline{FAULT}$	Fault Communication, Bidirectional Pin. It is used to indicate/receive detection of latching fault. See the <i>FAULT Reporting</i> section for more details. Connect this pin to the system bias supply rail through a 10k $\Omega$ resistor. 5V compliant, active-low pin.
13	PWRGD	Power Good Pin. Used to report $V_{IN}$ and $V_{OUT}$ status. See the <i>Power Good (PWRGD) Output</i> section for more details. Connect this pin to system bias supply rail through a 10k $\Omega$ resistor. This pin is 5V compliant.
14	ROCP	Moderate OCP Threshold Programming Input. Connect this pin to GND using an appropriate programming resistor. See the <i>Moderate OCP Threshold</i> section for additional details. No other components are allowed on this pin.
15	SMBUS_DATA	SMBus Data Pin.
16	SMBUS_ID	SMBus Address Programming and Current Hysteresis Flag Pin. Connect this pin to GND through a properly sized resistor to select desired address setting.
17	N.C.	Not Connected. Connect to GND through a 10k $\Omega$ resistor.
18	$V_{DD}$	Internal 1.8V Linear Regulator (LDO) Output. Connect this pin to GND through a 1 $\mu$ F (or higher) capacitor. No additional loads or components other than external properly sized capacitor are allowed on the $V_{DD}$ pin.

Block Diagram

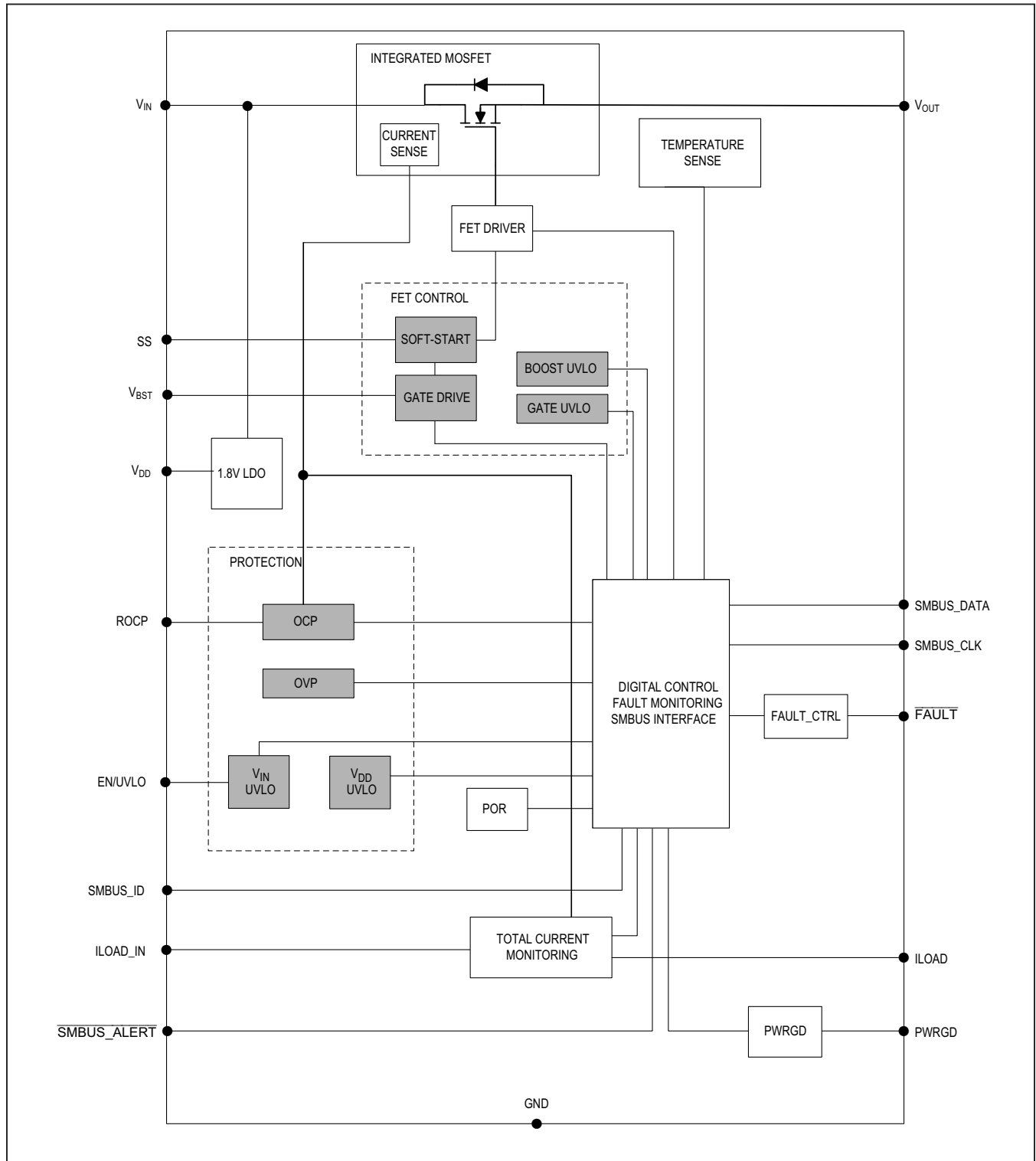



## Detailed Description

The MAX16550A/MAX16550B integrated power-protection ICs are designed to provide a complete single-chip protection solution for the 12V power bus. They combine power monitoring and control functions with a low on-resistance pass FET device that acts as a disconnect switch to limit maximum power distributed to the load. The ICs implement Maxim's proprietary integrated lossless current sensing techniques to provide a highly accurate and compact protection solution. The ICs integrate PMBus/SMBus interface for digital control and monitoring.

Refer to the IC [Block Diagram](#). An integrated N-channel power MOSFET is driven by the FET control circuit that includes a boost circuit to provide gate drive. An internal LDO provides  $V_{DD}$  IC bias supply, eliminating the need for external bias supply, enabling effective use of the device in hot-swap applications.

## Startup

The ICs enable the integrated 1.8V  $V_{DD}$  LDO once the 12V supply voltage is high enough to guarantee LDO operation. Once  $V_{DD}$  is valid, the ICs read the SMBus\_ID programming resistor value to set the PMBus address and initiate. During this period, the gate-drive

supply capacitor becomes fully charged. Once these two functions are complete, the ICs can be controlled through the enable input.

The enable input (EN/UVLO) has a precise threshold and provides a  $V_{IN\_UVLO}$  function, where the enable voltage is derived from  $V_{IN}$  through a resistor-divider, with an optional control signal used in conjunction with the divider, as shown in [Figure 5](#). The EN/UVLO pin must not be pulled high externally other than to pull the EN/UVLO pin high through a properly sized resistor-divider from the input supply. Though the enable signal can be pulled low to disable the part, this should only be allowed to occur when the input-voltage supply is within operating range, as specified in the [Electrical Characteristics](#) table.

## Startup Safe Operating Area (SOA)

During soft-start, it is important to keep the FET within its safe operating area. The peak current allowed during startup is shown in [Figure 1](#). In case resistive short is possible in the application, it is required to use startup OCP feature to protect the device. The startup OCP threshold must be lower than safe peak current. [Figure 1](#) assumes pure capacitive or RC load on the output.

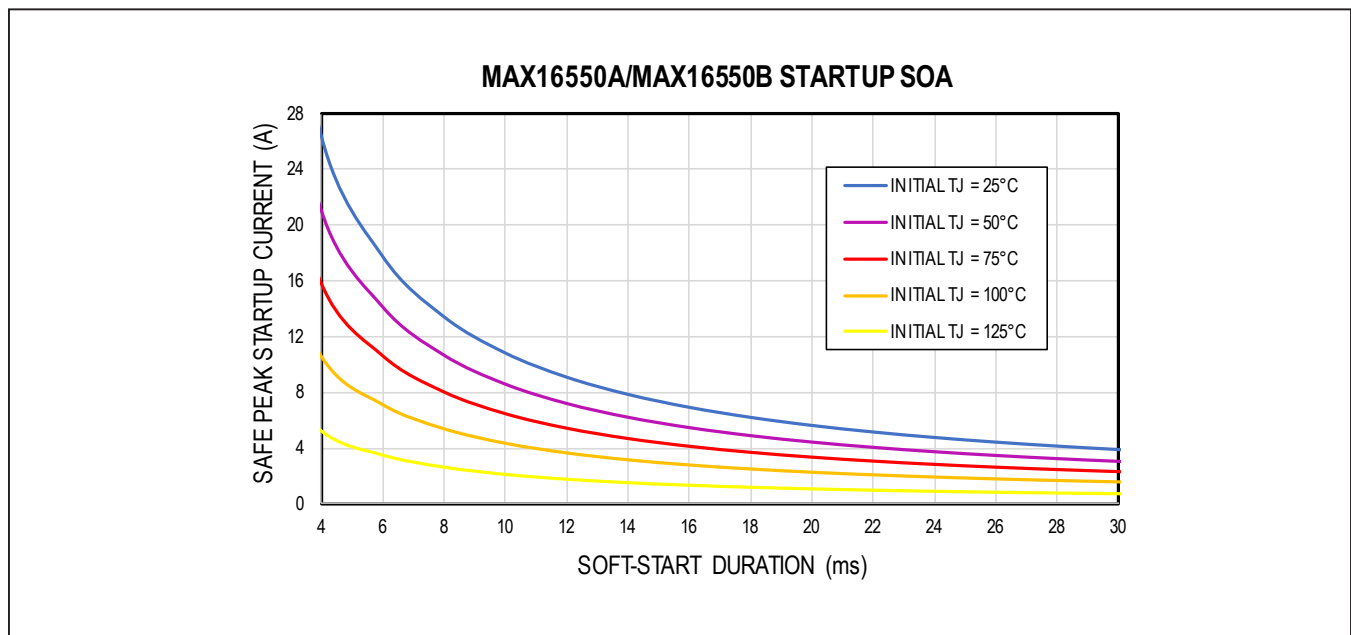

Figure 1. MAX16550A/MAX16550B Startup SOA

MAX16550A  
MAX16550B

Integrated Protection IC on 12V Bus with an  
Integrated MOSFET, Lossless Current Sensing,  
and PMBus Interface

**Self-Check**

Once  $V_{BST\_UVLO}$  has been cleared, the internal  $V_{DD\_LDO}$  is fully enabled and the EN/UVLO pin is above the enable threshold, the ICs initiate a timed output discharge as a self-check procedure. By default, the ICs initiate this procedure immediately after  $V_{BST\_UVLO}$  has been cleared and the internal  $V_{DD\_LDO}$  is fully enabled. Delay to start this procedure can be reprogrammed through PMBus. If the output does not fall below the programmed  $V_{OUT\_UVLO}$  threshold after a fixed period, the pass FET could potentially be shorted, with the ICs asserting both  $\overline{FAULT}$  and PWRGD pins low. The latched fault condition remains until restart (EN/UVLO or  $V_{IN}$  toggling, restarting through the OPERATIONS command). The threshold ( $V_{OUT\_UVLO}$ ) for the self-check procedure can be programmed to one of three different values through the PMBus. These values are programmed with the corresponding values for the PWRGD threshold. If the output voltage is below the programmed

$V_{OUT\_UVLO}$ , the self-check is considered passed and the ICs proceed with startup.

In addition, a soft-start capacitor discharge procedure is performed during every restart. The ICs utilize an integrated resistive element, with resistance approximately  $1.2k\Omega$ , to discharge the  $C_{SS}$  capacitor. The ICs check if the voltage across the  $C_{SS}$  capacitor is below the soft-start threshold shown in the *Electrical Characteristics* table after a fixed period of time. If the voltage across the  $C_{SS}$  capacitor is not below the softstart threshold, the ICs latch the pass FET off and assert the  $\overline{FAULT}$  pin low. The latched fault condition is kept until reset (EN/UVLO or  $V_{IN}$  toggling).

The ICs check the ROCP value at all times, including startup (after the bias supply is valid). This check ensures proper severe OCP threshold. If the wrong ROCP value is detected, the ICs report the fault by asserting the  $\overline{FAULT}$  signal low. The latched fault condition is kept until restart (EN/UVLO or  $V_{IN}$  toggling/restarting through the OPERATIONS command).

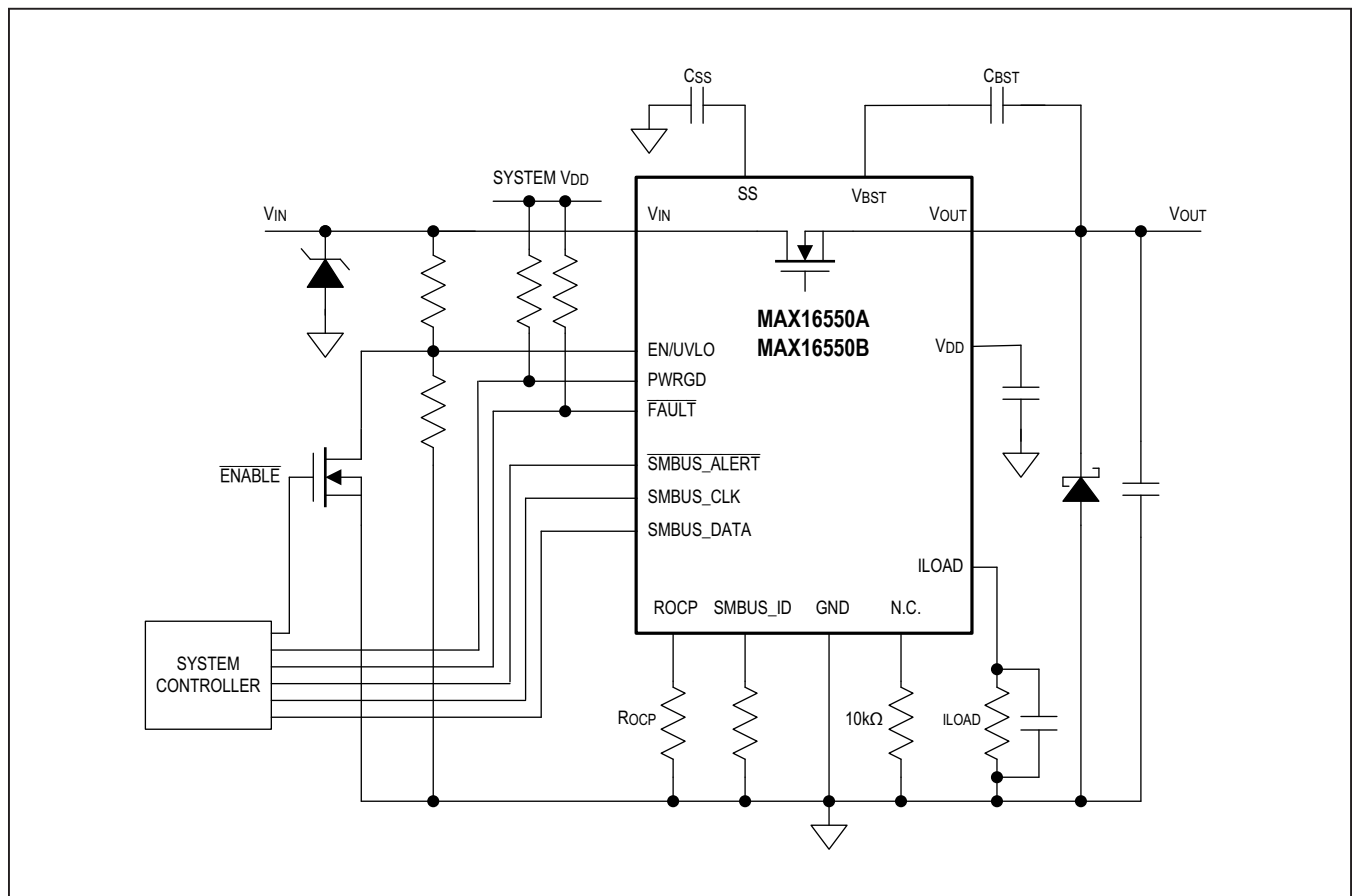

Figure 2. Typical Application Circuit

**Soft-Start**

Once the self-check procedure is complete, the output-voltage soft-start ramp is initiated. During startup, the  $C_{SS}$  capacitor is charged using a constant-current source. Since the integrated FET is configured as a source follower, the output voltage is ramped monotonically at a rate determined by the external soft-start capacitor.

**V<sub>DD</sub> UVLO**

The ICs implement V<sub>DD</sub> UVLO fault monitor and protection. V<sub>DD</sub> is monitored at all times. Startup

procedures are not initiated until V<sub>DD</sub> UVLO is cleared. If V<sub>DD</sub> falls below V<sub>DD</sub> UVLO during normal operation, this fault is latched and V<sub>IN</sub> power cycle/toggle is required to reset this latching fault.

**Current Hysteresis**

The SMBUS\_ID pin is used as a current-hysteresis flag after SMBUS\_ID decoding is completed. If the output current is greater than the HYST\_HIGH level, the current-hysteresis flag is set to high. If output current is less than the HYST\_LOW level, then the current-hysteresis flag is set to low.

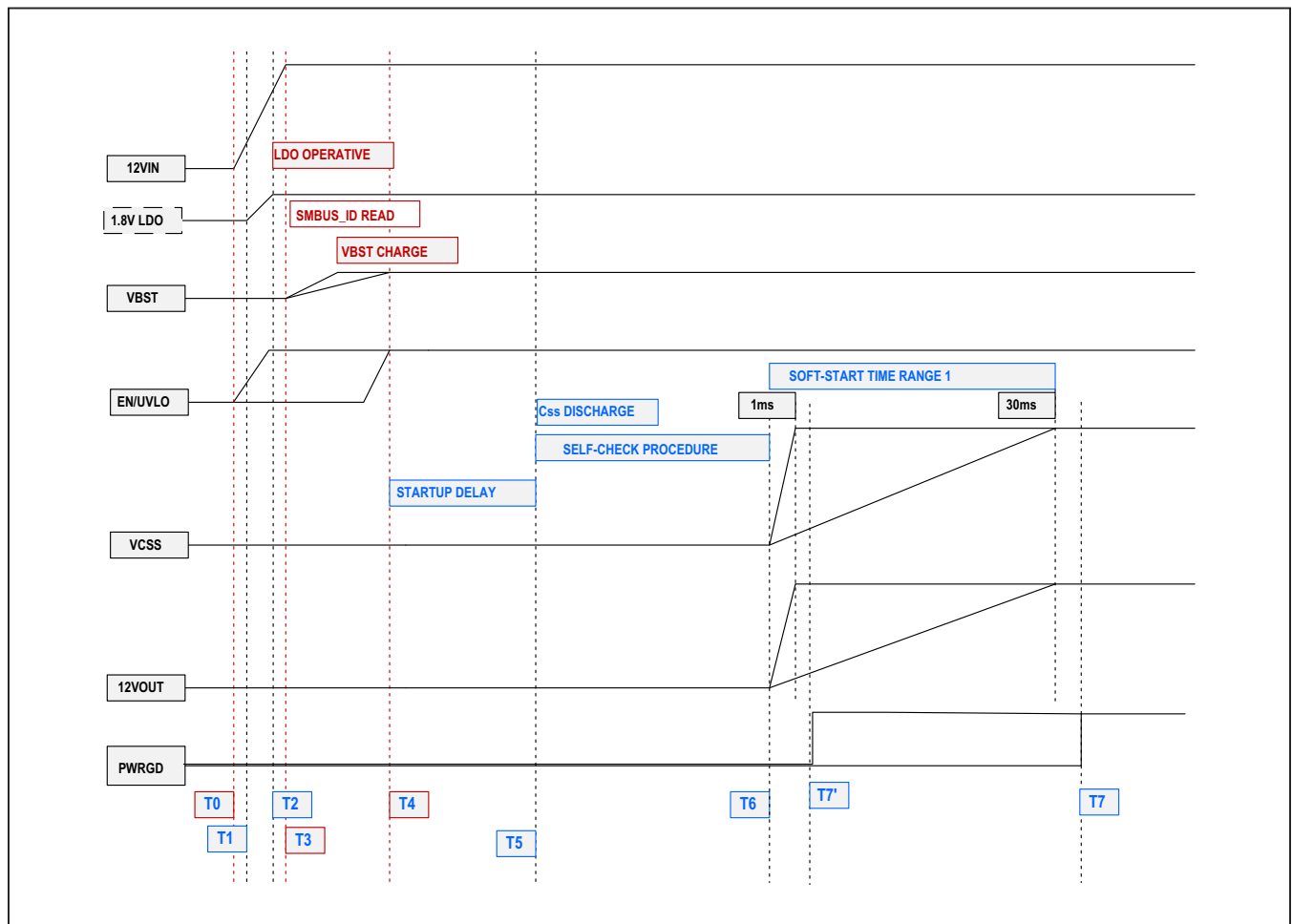

Figure 3. Startup Timing Diagram

**Table 1. Timing Diagram Example Shown in Figure 3**

POINT/ PERIOD	DESCRIPTION
t0	12V $V_{IN}$ applied.
t1	The LDO has enough headroom to start up. $V_{IN} > 2V$ (typ).
t2	The internal 1.8V LDO is ready and the MAX16550A/MAX16550B logic is fully operational. External bypass capacitors connected to the $V_{DD}$ pin are fully charged. 700 $\mu$ s (typ).
t3, t4	SMBus ID resistor reading and $V_{BST}$ charging. EN/UVLO signal status is ignored from t3 to t4. 150 $\mu$ s (typ).
t4	EN/UVLO is active. Startup check-up procedures can be started after the EN/UVLO is cleared.
t4, t5	User-programmable startup delay (2.5ms to 22.5ms).
t5, t6	Self-check procedure. $C_{SS}$ discharge.
t6, t7	$V_{OUT}$ ramp (1ms–30ms).
t7	Power-good (PWRGD) output asserted. 6ms (typ).
t7+	PWRGD is high, normal operation starts.

### SMBus ID Resistor Out of Range

After  $V_{DD}$  UVLO is cleared, the SMBus ID programming resistor is read. If it is out of range, a latching fault is tripped. This fault can be cleared by EN/UVLO or  $V_{IN}$  toggling or restarting through the OPERATIONS command. The latter may mean pulling EN/UVLO above the threshold and then low after the fault is detected to reset the fault latch. The value is read again when EN/UVLO goes high for the second time.

### VBOOST, VGS UVLO

$V_{BOOST}$  UVLO is checked when EN/UVLO is above the enable threshold and remains active while the device is enabled. If  $V_{BOOST}$  UVLO is tripped before the FET is turned on, the latching fault can still be reset by EN/UVLO or  $V_{IN}$  toggling or restarting through the OPERATIONS command. The gate-drive ( $V_{GS}$ ) UVLO protection has 10 $\mu$ s internal deglitching filtering, which prevents false tripping due to output-voltage overshoot if a large, fast unloading transient is present. An external capacitance can be placed between the  $V_{OUT}$  and  $V_{SS}$  pins for filtering.  $V_{BOOST}$  and  $V_{GS}$  UVLO are latching faults, which result

in the pass FET being latched off and  $\overline{FAULT}$  asserted low.  $V_{GS}$  UVLO is masked for 100ms during startup to avoid tripping a latching fault.

### $V_{IN}$ UVLO

The  $V_{IN}$  UVLO is fed through a resistor-divider to the EN/UVLO pin and therefore provides a programmable threshold on the 12V input rail. The EN/UVLO pin includes hysteresis and if the pin falls below the programmed value during operation, the device turns the integrated FET off and PWRGD is deasserted. The integrated FET is turned on again if the positive threshold is exceeded and performs self-check and soft-start for each cycle.  $V_{IN}$  UVLO warning is also provided through the PMBus.

### Overcurrent Detection

The MAX16550A/MAX16550B actively monitors load current on the 12V power bus load at all times, including startup. Startup OCP is active during startup until the power-good (PWRGD) flag is set. If, at any time during startup, load current rises above the startup threshold, the integrated pass FET turns off within 10 $\mu$ s and the  $\overline{FAULT}$  pin is asserted low. This is a latching fault.

The MAX16550A/MAX16550B provides three levels of overcurrent protection during normal operation (after the startup procedure is complete and the PWRGD flag is set high). The “moderate” OCP threshold is set using an analog external resistor and is therefore programmable over a wide continuous range. This OCP allows a higher current to be sustained for a period less than a programmable timeout period without shutting down the device to allow for short surges that pose no threat to the device and are normal operating conditions. If the load current on the 12V power bus exceeds the moderate OCP threshold for the entire timeout period, but its magnitude is less than a programmable severe overcurrent threshold (Table 11), the integrated pass FET switches off at the end of the timeout period and the  $\overline{FAULT}$  pin is asserted low to indicate a moderate OCP fault condition. Restarting the system requires EN/UVLO or  $V_{IN}$  toggling or restarting through the OPERATIONS command. Moderate OCP timeout is user programmable through SMBus, with four different values.

The second level of OCP protection is a “severe OCP.” Severe OCP threshold is programmed relative to moderate OCP threshold using PMBus. If at any time the load current exceeds the severe OCP threshold, the MAX16550A/MAX16550B turns the integrated pass FET off in less than 5 $\mu$ s, and asserts the  $\overline{FAULT}$  pin low. Severe overcurrent protection is a latching fault.

# MAX16550A MAX16550B

## Integrated Protection IC on 12V Bus with an Integrated MOSFET, Lossless Current Sensing, and PMBus Interface

The MAX16550A/MAX16550B features a third level of protection against severe overload faults, called “safe OCP,” with 60A internally fixed threshold. It assures that the integrated pass FET is protected from exceeding its safe operating condition at all times. If at any time the load current on the 12V power bus exceeds the safe OCP threshold, the device turns the pass FET off within 250ns and asserts the  $\overline{\text{FAULT}}$  pin low. The severe OCP threshold should be set to a value less than the safe OCP threshold.

The MAX16550A/MAX16550B supports on-the-fly moderate OCP threshold changes. The concept is shown in Figure 4. If the resistance seen by the ROCP pin is changed during operation, the MAX16550A/MAX16550B adjusts the moderate OCP threshold to match the value selected by the external resistive network.

### Overvoltage Protection (OVP)

The MAX16550A features  $V_{\text{IN}}$  overvoltage protection to protect the system from an overvoltage event that could harm the downstream circuitry. The input voltage is constantly monitored, and if at any time it rises above the overvoltage-protection threshold, the pass FET is latched off,  $\overline{\text{FAULT}}$  asserted low, and a fault reported. This is a latching fault. Overvoltage protection is disabled in the MAX16550B.

### Wrong ROCP Protection

The ICs are protected against out-of-range ROCP values. Protection is enabled at all operating conditions, including startup. Wrong ROCP is considered a severe, latching fault, so if at any time the ROCP value is detected out of the permitted range, the ICs latch the integrated FET off, and assert the  $\overline{\text{FAULT}}$  pin low. An EN/UVLO or  $V_{\text{IN}}$  toggling or a restart through the OPERATIONS command must be performed to clear the fault and restart the ICs. If ROCP is changed during operation by the system (see Figure 4), the design must be such that ROCP is within range at all times.

### Overtemperature Protection (OTP)

The ICs include protection against overtemperature conditions. If the junction temperature exceeds the programmable threshold, the IC latches the integrated FET off and asserts the  $\overline{\text{FAULT}}$  output low. To re-enable the IC, the following options are available:

- Toggling EN/UVLO or  $V_{\text{IN}}$
- Restarting through the OPERATIONS command

The overtemperature threshold is user programmable through the PMBus.

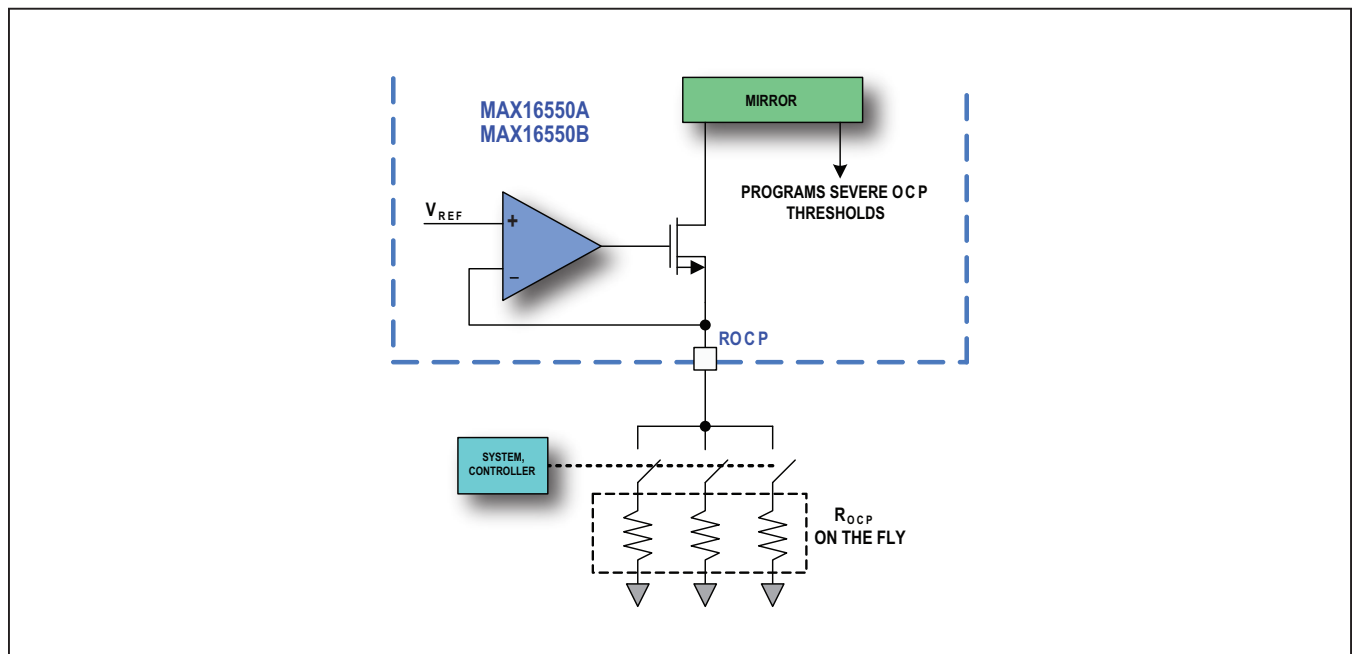

Figure 4. On-The-Fly Analog Programmable Moderate OCP Threshold

**Table 2. Faults Detected and Actions**

PARAMETER	DESCRIPTION	$\overline{\text{FAULT}}$ ASSERTED	LATCHING
V <sub>DD</sub> UVLO	Internal V <sub>DD</sub> LDO UVLO	N/A*	N/A*
V <sub>BOOST</sub> UVLO	UVLO for V <sub>BOOST</sub> voltage	Yes	Yes
V <sub>GS</sub> UVLO	UVLO for V <sub>GS</sub> voltage	Yes	Yes
V <sub>IN</sub> UVLO	EN/UVLO pin below threshold	No	No
R <sub>OCP</sub>	R <sub>OCP</sub> detected as being out of valid range	Yes	Yes
R_SMBus_ID	SMBus_ID resistor detected as being out of range	Yes	Yes
C <sub>SS</sub> Discharge	Soft-start capacitor discharge failed	Yes	Yes
FET Short	Pass FET short detected during startup self-check	Yes	Yes
Startup OCP	Startup overcurrent fault detected	Yes	Yes
Severe OCP	Severe overcurrent fault detected	Yes	Yes
Safe OCP	Safe overcurrent fault detected	Yes	Yes
OTP	Overtemperature-fault threshold exceeded	Yes	Yes
V <sub>IN</sub> OVP	V <sub>IN</sub> overvoltage detected (MAX16550A)	Yes	Yes

**Note 1:** If V<sub>BST</sub>\_UVLO fault occurs before startup,  $\overline{\text{FAULT}}$  is not reported and status registers are not updated.

**Note 2:** V<sub>IN</sub>\_UVLO clears  $\overline{\text{FAULT}}$  and the latching event.

### $\overline{\text{FAULT}}$ Fault Reporting

The ICs provide a dedicated pin ( $\overline{\text{FAULT}}$ ) for fault reporting. If at any time a latching fault is detected, the  $\overline{\text{FAULT}}$  pin is immediately latched low. An EN/UVLO or V<sub>IN</sub> toggling or restart through the OPERATIONS command is required to reset the ICs after a latching-fault detection.

### Fault Input and $\overline{\text{FAULT}}$ Pullup

The  $\overline{\text{FAULT}}$  pin is a bidirectional open-drain pin that can be used for fault communication from external circuitry to the ICs. To communicate a fault to the ICs, the external circuitry must pull the  $\overline{\text{FAULT}}$  pin low. If  $\overline{\text{FAULT}}$  is externally pulled low, the ICs treat it as a latching fault; therefore, the pullup voltage source must be considered to ensure the rail is operational and pulled high before the ICs' startup cycle.

These are the options for the pullup rail:

- MAX16550A/MAX16550B V<sub>DD</sub>: 1.8V internal LDO rail. This rail is limited to 1.8V, so the external system has to be compliant with that rail.
- System 3.3V or 5V Rail:  $\overline{\text{FAULT}}$  is 5V compliant;

therefore, an external higher voltage rail can be used for pullup. This rail has to be stable when the ICs are initiating their startup procedure. If it is not, a potential false-fault communication may occur.

### Power-Good (PWRGD) Output

The ICs provide a dedicated pin for power-good reporting (PWRGD). PWRGD is asserted high after startup, when the output node is charged above the programmed PWRGD threshold and the FET is fully enhanced and operating in its resistive region. In all the other conditions, the PWRGD pin is deasserted low.

PWRGD is an open-drain pin; thus, an external pullup resistor connected to the pullup supply rail is needed. Different options are available for the pullup rail:

- MAX16550A/MAX16550B V<sub>DD</sub>: 1.8V internal LDO rail. This rail is limited to 1.8V, so the external system has to be compliant with that rail.
- System 3.3V or 5V Rail: PWRGD is 5V compliant; therefore, an external higher voltage rail can be used for pullup.

**Table 3. Requirements for PWRGD Assertion**

PARAMETER	CONDITION
V <sub>OUT</sub>	V <sub>OUT</sub> > PWRGD Threshold
V <sub>IN</sub>	V <sub>IN</sub> > V <sub>IN_UVLO</sub>
Self-Check	MOSFET (V <sub>IN</sub> to V <sub>OUT</sub> ) short not detected during startup.
V <sub>GS</sub>	FET on and in triode region. 5ms delay before PWRGD assertion after this condition is met.

**Table 4. PMBus/SMBus Reporting**

PARAMETER	CONDITION
V <sub>IN</sub>	Input voltage (PMBus compliant)
I <sub>OUT</sub>	Output current (PMBus compliant)
P <sub>IN</sub>	Input power (PMBus compliant)
E <sub>IN</sub>	Input energy (PMBus compliant)
Temperature	MAX16550A/MAX16550B chip temperature (PMBus compliant)
Peak V <sub>IN</sub>	Peak value of input voltage (direct reading)
Peak I <sub>OUT</sub>	Peak value of output current (direct reading)
Peak P <sub>IN</sub>	Peak value of input power (direct reading)
Peak Temperature	Peak value of IC temperature (direct reading)
Peak V <sub>OUT</sub>	Peak value of output voltage (direct reading)

**Table 5. MAX16550A/MAX16550B Programmability**

PARAMETER	PROGRAMMABILITY TYPE	COMPONENT	CONDITION
Moderate (MAX16550A/B) OCP Threshold	Analog	ROCP	R_OCP
Soft-Start Ramp Rate	Analog	C <sub>SS</sub>	SS
Input UVLO Threshold	Analog	Divider	EN/UVLO
PMBus Address	Programming Resistor	SMBus_ID Resistor	SMBus_ID
Power Fault Timeout	Digital	PMBus_Reg D0h[6:5]	SMB_DATA
Severe OCP Threshold	Digital	PMBus_Reg D0h[7]	SMB_DATA
Startup Delay	Digital	PMBus_Reg D0h[12:11]	SMB_DATA
Output PWRGD Threshold (sets V <sub>OUT</sub> UVLO and self-check thresholds)	Digital	PMBus_Reg D0h[9:8]	SMB_DATA
Self-Check Threshold	Digital	PMBus_Reg D0h[9:8]	SMB_DATA
Overtemperature Warning and Fault Thresholds	Digital	PMBus_Reg 51h, PMBus_Reg 4Fh	SMB_DATA
Input Overpower Warning Threshold and Fault Thresholds	Digital	PMBus_Reg 6Bh, PMBus_Reg F5h	SMB_DATA
Reporting and Warning Averaging Sample Size	Digital	PMBus_Reg DDh[3:0], PMBus_Reg D0h[1:0]	SMB_DATA
V <sub>IN</sub> Undervoltage Warning and Fault Thresholds	Digital	PMBus_Reg 58h, PMBus_Reg 59h	SMB_DATA
Overcurrent Warning	Digital	PMBus_Reg 4Ah	SMB_DATA
V <sub>OUT</sub> Undervoltage Warning Threshold	Digital	PMBus_Reg 43h	SMB_DATA
ILOAD Voltage Gain	Analog	ILOAD Resistor	ILOAD

### Analog Load Current Signal Output

The ICs include an output pin (ILOAD) that allows the user to monitor the load current through the ICs. The current sourced by the ILOAD pin is proportional to the current through the device with the ratio shown in the [Electrical Characteristics](#) table. A properly sized resistor between the ILOAD pin and GND should be added. The ICs report zero current on the ILOAD pin during soft-start, and start reporting load current once the pass FET  $V_{GS}$  is above its UVLO threshold (i.e., the pass FET is in its resistive region).

### PMBus/SMBus Reporting and Warning

The ICs provide PMBus-compliant digital telemetry through the PMBus, as shown in [Table 4](#). The ICs include a digital multiply function that provides a reading for input power and input energy. For average values, the sample size is programmable. Peak values for input/output voltage, output current, input power, and temperature are stored in dedicated manufacturer-specific registers. The ICs also provide warning functions based on programmable warning thresholds, as specified in the PMBus specification. The sample size for warning flags is also programmable.

### Configuration

The ICs are configured using both analog programming resistors and also through the PMBus. See [Table 5](#) for programmable parameters.

### Severe OCP Threshold

The severe OCP threshold is externally programmable through a resistor connected to the ROCP pin as shown in Equations 1 and 2 (see the [Electrical Characteristics](#) table for  $V_{OCPM}$  and  $G_{OCP}$ ).

#### Equation 1:

$$I_{OCP\_SEV} = \frac{V_{OCPM}}{R_{OCP}} \times G_{OCP} \times OCP\_CFG$$

where:

$I_{OCP\_SEV}$  = Severe overcurrent-protection threshold (A)  
 $V_{OCPM}$  = Overcurrent-protection reference voltage shown in the [Electrical Characteristics](#) table (V)  
 $G_{OCP}$  = Overcurrent protection gain shown in the [Electrical Characteristics](#) table ( $\mu A/A$ )

$R_{OCP}$  = Value of overcurrent-protection programming resistor ( $\Omega$ )

$OCP\_CFG$  = Scale factor. Refer to the [Electrical Characteristics](#) table for details.

#### Equation 2:

$$R_{OCP} = \frac{V_{OCPM}}{I_{OCP\_REF}} \times G_{OCP} \times OCP\_CFG$$

where:

$I_{OCP\_SEV}$  = Severe overcurrent-protection threshold (A)

$V_{OCPM}$  = Overcurrent-protection reference voltage shown in the [Electrical Characteristics](#) table (V)

$G_{OCP}$  = Overcurrent-protection gain shown in the [Electrical Characteristics](#) table (A/A).

$R_{OCP}$  = Value of overcurrent-protection programming resistor ( $\Omega$ )

#### Design Example (MAX16550A):

To set moderate OCP to 35A nominal, using Equation 2:

$$R_{OCP} = \frac{0.8V}{35A} \times (4 \times 10^6) \\ = 91.5k\Omega$$

### Soft-Start Capacitor ( $C_{SS}$ )

During startup, the pass FET device is operated as a source follower. Soft-start capacitor  $C_{SS}$  is connected between the MOSFET's gate and ground and is charged from a fixed current source. The external  $C_{SS}$  capacitor therefore charges linearly and this produces a linear monotonic ramp for  $V_{OUT}$ . The ramp rate is programmable by selecting the appropriate value for  $C_{SS}$ .

The ramp rate for the voltage across  $C_{SS}$  and  $V_{OUT}$  is given by Equation 5.

#### Equation 5:

$$\frac{dV}{dt} = \frac{i_{SS}}{C_{SS}}$$

where:

$dV/dt$  = Voltage ramp rate of  $V_{OUT}$  (V/ $\mu s$ )

$i_{SS}$  = Soft-start current source (mA)

$C_{SS}$  = External  $C_{SS}$  capacitor value (nF)



MAX16550A  
MAX16550B

Integrated Protection IC on 12V Bus with an  
Integrated MOSFET, Lossless Current Sensing,  
and PMBus Interface

Assuming  $V_{IN} = 12V$ , Equation 5 can be used to derive the soft-start time given by Equation 6.

**Equation 6:**

$$t_{SS} = \frac{12V \times C_{SS}}{i_{SS}}$$

where:

$t_{SS}$  = Ramp duration ( $\mu s$ )

$i_{SS}$  = Soft-start current (mA)

$C_{SS}$  = External soft-start capacitor value (nF)

Assuming the load inrush current is due to the output capacitance only, the load current is given by Equations 7 and 8.

**Equation 7:**

$$I_{IN} = I_{OUT} = C_{OUT} \times \frac{dV}{dt}$$

where:

$I_{OUT}$  = Load inrush current(A)

$C_{OUT}$  = Load capacitance ( $\mu F$ )

**Equation 8:**

$$I_{IN} = I_{OUT} = \frac{C_{OUT} \times i_{SS}}{C_{SS}}$$

where:

$I_{OUT}$  = Load inrush current(A)

$C_{OUT}$  = Load capacitance ( $\mu F$ )

$C_{SS}$  = External soft-start capacitor value (nF)

$i_{SS}$  = Soft-start current (mA)

Therefore, the soft-start capacitor can be selected based on the design value of inrush current using Equation 9.

**Equation 9:**

$$C_{SS} = \frac{C_{OUT} \times i_{SS}}{I_{INRUSH}}$$

where:

$I_{INRUSH}$  = Desired maximum inrush current due to  $C_{LOAD}$  (A)

$C_{OUT}$  = Load capacitance (mF)

$C_{SS}$  = External soft-start capacitor value (nF)

$i_{SS}$  = soft-start current ( $\mu A$ )

In order to achieve optimal low-loss operation of the pass FET, the ICs monitor the value of the pass FET  $V_{GS}$ . The  $V_{GS}$  UVLO is enabled approximately 100ms (according to the [Electrical Characteristics](#) table) after startup initiation. This places an upper limit on  $C_{SS}$  and  $t_{SS}$ .

Note that if load unloading transients with  $di/dt > 2.5A/ms$  large enough to cause output-voltage transients  $> \sim 100mV$ , an additional capacitor between SS and  $V_{OUT}$  is recommended to ensure the pass FET  $V_{GS}$  remains above its UVLO threshold. This capacitor has no noticeable effect on soft-start ramp time as the differential voltage from  $V_{OUT}$  to SS remains approximately constant in soft-start.

**Design Example:**

Assume a maximum design value for inrush current of 10A, and a load capacitance of 2mF.

$$C_{SS} = \frac{(2mF) \times (30\mu A)}{10A}$$

$$= 6nF \text{ minimum (to meet inrush maximum)}$$

Use Equation 6 to show that corresponding  $t_{SS}$  in this example is 2.4ms, which is well below the 100ms limit.

**Input UVLO**

The input UVLO is set using a resistor-divider circuit, as shown in [Figure 5](#). The enable threshold,  $V_{IN\_UVLO}$  is given in the [Electrical Characteristics](#) table. The corresponding value for the  $V_{IN}$  rail is given by Equation 10.

**Equation 10:**

$$V_{IN} = \frac{V_{IN\_UVLO}}{K}$$

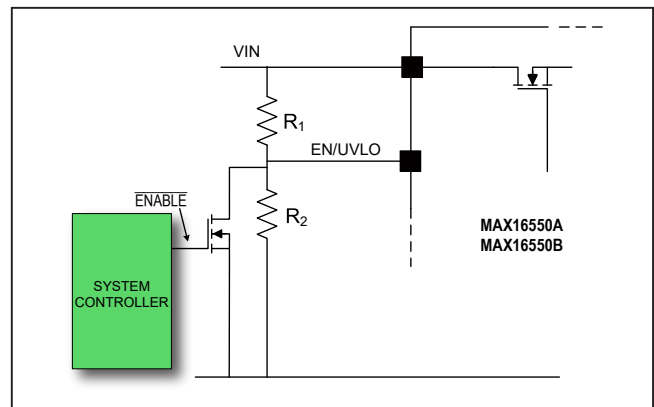

Figure 5. Programming Resistors for Input UVLO

MAX16550A  
MAX16550B

Integrated Protection IC on 12V Bus with an  
Integrated MOSFET, Lossless Current Sensing,  
and PMBus Interface

or

Equation 11:

$$K = \frac{(V_{IN\_UVLO})}{V_{IN}}$$

where:

$V_{IN}$  = 12V rail input voltage to enable device (V)

$V_{IN\_UVLO}$  = EN/UVLO threshold (V)

K = Resistor-divider ratio,  $R2/(R1 + R2)$

**Design Example:**

To guarantee system startup at 10.8V using Equation 11.

$$\begin{aligned} K &= \frac{1.0V}{10.8V} \\ &= 0.0926 \\ \text{set } R2 &= 10k\Omega \\ R1 &= 98k\Omega \end{aligned}$$

### PMBus Address Programming

The PMBus address is programmed to one of 16 values using the external resistor, as shown in [Table 6](#).

### ILOAD Reporting

The current-reporting voltage is set using an external resistor connected from ILOAD to ground. The maximum voltage is shown in the [Electrical Characteristics](#) table. The reporting voltage gain is given by Equation 12. Assuming a maximum signal voltage of 1.35V, Equation 14 can be used to select a value for  $R_{ILOAD}$  based on a desired full-scale current.

Equation 12:

$$V_{ILOAD} = R_{ILOAD} \times I_{LOAD} \times G_{ILOAD}$$

Equation 13:

$$R_{ILOAD} = \frac{1.35V}{I_{LOAD\_FSD} \times G_{ILOAD}}$$

where:

$V_{ILOAD}$  = Current-reporting voltage (V)

$R_{ILOAD}$  = External current-reporting resistor (k $\Omega$ )

$I_{LOAD}$  = Load current  $I_{OUT} = I_{IN}$  (A)

$I_{LOAD\_FSD}$  = Desired full-scale of current reporting (A)

$G_{ILOAD}$  = Current-reporting gain from the [Electrical Characteristics](#) table

**Table 6. PMBus Address Programming Resistor Values**

VALUE	R_SMBUS_ID (k $\Omega$ )	SMBus ID
0	1.78	40h
1	2.37	41h
2	3.16	42h
3	4.22	43h
4	5.62	44h
5	7.5	45h
6	9.76	46h
7	13	47h
8	17.4	10h
9	23.2	11h
10	30.9	12h
11	41.2	13h
12	54.9	50h
13	73.2	51h
14	97.6	52h
15	127	53h

**Note:** RSMBus\_ID should be 1% or better.

**Table 7. Parameters Programmed through PMBus and Default Values**

PARAMETER	DEFAULT VALUE
Overtemperature-Protection Threshold	140°C
$V_{OUT}$ PWRGD/Self-Check Thresholds	11V/9V
Moderate OCP Timeout	100 $\mu$ s (MAX16550A/B)
Startup Delay	0 $\mu$ s
Severe OCP Threshold	130%
Overtemperature Warning Threshold	220°C (Disabled by Default)
Pin Warning Threshold	(Disabled by Default)
Overcurrent Warning	(Disabled by Default)
$V_{IN}$ Undervoltage Warning	(Disabled by Default)
$V_{OUT}$ Undervoltage Warning	(Disabled by Default)
Current Hysteresis	(Disabled by Default)

For example, to set the full-scale current reported to 23A:

$$\begin{aligned} \text{RILOAD} &= \frac{1.35\text{V}}{23\text{A} \times (5 \times 10^{-6})} \\ &= 11.8\text{K}\Omega \end{aligned}$$

### PMBus Reporting and Warning Settings

The ICs provide single-sample, averaged and peak values for voltage, current, and power reporting, as well as single reading or averaged readings for warnings. The limits for these parameters and warnings should be set through PMBus prior to operation if a value other than the default is required.

Averaging for voltage, power, and current uses a “accumulate-and-dump” technique, whereas temperature uses a shifting window/rolling average. Power is calculated for every voltage and current sample (as opposed to using averaged voltage and current), and the result is accumulated in a dedicated register for averaging.

Two independently programmable averaging sample sizes are used for reporting and warning/status register use for voltage, current and power:

- Reporting:  $2^N$  samples, with  $N = 0$  to 16 (1 sample to 32K samples)
  - Sample size is set using Reg\_DDh (CONFIG\_2, manufacturer-specific register)
- Warning:  $2^M$  samples, with  $M = 0$  to 3 (1 sample to 8 samples)
  - Sample size is set using Reg D0h (CONFIG, manufacturer-specific register)

The ICs support fault and status reporting except for  $V_{\text{BST\_UVLO}}$  fault at startup. If the  $V_{\text{BST\_UVLO}}$  occurs at startup the device latches off,  $\overline{\text{FAULT}}$  is not reported, and status registers are not updated.

### Setting PMBus-Programmable Parameters

See [Table 7](#) for parameters that are programmed through the PMBus. If a setting other than the default shown below is required, it must be programmed through PMBus. Note that some parameters have an enable bit as well as value bits.

### SMBus/PMBus Registers

#### STATUS\_MFR\_SPECIFIC Register (80h)

This is a single-byte register used to read the status of the self-check and fault indicators.

#### ALERT Behavior

Any of the STATUS bits (with some exception) assert the alert line low.

Exceptions are:

- Bit OFF of STATUS\_BYTE/STATUS\_WORD
- Bit POWERGOOD#/MFR\_SPECIFIC of STATUS\_WORD

Alert line can be configured to mask any of the STATUS bits using the SMBALERT\_MASK register.

The only ways to release the alert line are:

- CLEAR\_FAULTS command
- ARA (refer to the SMBus spec v2.0)

MAX16550A  
MAX16550B

Integrated Protection IC on 12V Bus with an  
Integrated MOSFET, Lossless Current Sensing,  
and PMBus Interface

**Table 8. PMBus/SMBus Registers**

ADDRESS (HEX)	PROGRAMMABILITY (Note 1)	TYPE	BYTES	DEFAULT (HEX)
1	OPERATION	RW	1	80
3	CLEAR_FAULTS	WO	0	0
19	CAPABILITY	RO	1	B0
1B	SMBALERT_MASK	(Note 2)	2	0000
43	VOUT_UV_WARN_LIMIT	RW	2	0000
4A	IOUT_OC_WARN_LIMIT	RW	2	03FF
4F	OT_FAULT_LIMIT	RW	2	0358
51	OT_WARN_LIMIT	RW	2	03FF
58	VIN_UV_WARN_LIMIT	RW	2	0000
59	VIN_UV_FAULT_LIMIT	RW	2	0000
6B	PIN_OP_WARN_LIMIT	RW	2	0000
78	STATUS_BYTE	RO	1	0
79	STATUS_WORD	RO	2	0
7A	STATUS_VOUT	RO	1	0
7B	STATUS_IOUT	RO	1	0
7C	STATUS_INPUT	RO	1	0
7D	STATUS_TEMPERATURE	RO	1	0
7E	STATUS_CML	RO	1	0
80	STATUS_MFR_SPECIFIC	RO	1	0
86	READ_EIN	RO	7	0
88	READ_VIN	RO	2	0
89	READ_IIN	RO	2	0
8B	READ_VOUT	RO	2	0
8C	READ_IOUT	RO	2	0
8D	READ_TEMPERATURE	RO	2	0
97	READ_PIN	RO	2	0
98	PMBUS_REVISION	RO	1	2
99	MFR_ID	BLK	6	MAXIM
9A	MFR_MODEL	BLK	6	16550A/ 16551A
9B	MFR_REVISION	BLK	2	2
D0	CONFIG	RW	2	0
D1	PEAK_VIN	RO	2	0
D2	PEAK_IOUT	RO	2	0
D3	PEAK_PIN	RO	2	0
D4	PEAK_TEMP	RO	2	0

**Table 8. PMBus/SMBus Registers (continued)**

ADDRESS (HEX)	PROGRAMMABILITY (Note 1)	TYPE	BYTES	DEFAULT (HEX)
D5	CLEAR_PEAKS	WO	0	0
DD	CONFIG2	RW	1	0
F2	HYST_LOW	RW	2	03FF
F3	HYST_HIGH	RW	2	03FF
F4	HYST_STATUS	RO	1	0
F5	PIN_OP_FAULT_LIMIT	RW	2	5540
FD	PEAK_VOUT	RO	2	0

**Note 1:** Registers shown in bold (1h - 9Dh) comply with PMBus Power Management Protocol Specifications. Refer to the PMBus specification and see [Table 15](#) for more details.

**Note 2:** SMBALERT\_MASK is written to a write\_word command and read with a read from a write\_block\_read\_process\_call with a num\_bytes field of 1.

**Table 9. Register 80h**

BIT #	BIT NAME	DESCRIPTION	READING	INDICATION
[7]	SELFHECK_FAULT	Pass FET and Soft-Start Self-Check	0	Pass
			1	Fail
[6]	ROCP_FAULT	ROCP Check	0	Pass
			1	Fail
[5]	R_SMBUSID_FAULT	SMBus Programming Resistor Check	0	Pass
			1	Fail
[4]	FOLLOWER_FAULT	Fault Input	0	No Fault Input
			1	Fault Input
[3]	GATE_UVLO_FAULT	V <sub>GS</sub> UVLO Fault	0	No Fault
			1	Fault
[2]	BST_UVLO_FAULT	V <sub>BOOST</sub> UVLO Fault	0	No Fault
			1	Fault
[1]	—	Not Used	0	—
			1	—
[0]	PIN_OP_FAULT	PIN_OP_FAULT	0	Pass
			1	Fault

Table 10. MAX16550A/MAX16550B PMBus Register Map

ADDRESS	DEC	NAME	TYPE	WIDTH	DEFAULT	LOW BYTE								HIGH BYTE																								
						B7	B6	B5	B4	B3	B2	B1	B0	B15	B14	B13	B12	B11	B10	B9	B8																	
01	1	OPERATION	RW	1	80	enable	0	0	0	0	0	0	0	0	0	0	0	0	0	0	0	0	0	0	0	0	0	0	0	0	0	0	0					
03	3	CLEAR_FAULTS	WO	0	0	—	—	—	—	—	—	—	—	—	—	—	—	—	—	—	—	—	—	—	—	—	—	—	—	—	—	—	—	—				
19	25	CAPABILITY	CN	1	B0	1	0	1	1	0	0	0	0	0	0	0	0	0	0	0	0	0	0	0	0	0	0	0	0	0	0	0	0	0				
1B	27	SMBALERT_MASK	**	2	0000	—	—	—	—	—	—	—	—	—	—	—	—	—	—	—	—	—	—	—	—	—	—	—	—	—	—	—	—	—	—			
43	67	VOUT_UV_WARN_LIMIT	RW	2	0	vout_uv_warn_th[7]	vout_uv_warn_th[6]	vout_uv_warn_th[5]	vout_uv_warn_th[4]	vout_uv_warn_th[3]	vout_uv_warn_th[2]	vout_uv_warn_th[1]	vout_uv_warn_th[0]	0	0	0	0	0	0	0	0	0	0	0	0	0	0	0	0	0	0	0	0	0	0			
4A	74	IOUT_OC_WARN_LIMIT	RW	2	03FF	ocp_warn_th[7]	ocp_warn_th[6]	ocp_warn_th[5]	ocp_warn_th[4]	ocp_warn_th[3]	ocp_warn_th[2]	ocp_warn_th[1]	ocp_warn_th[0]	0	0	0	0	0	0	0	0	0	0	0	0	0	0	0	0	0	0	0	0	0	0	0		
4F	79	OT_FAULT_LIMIT	RW	2	03FF	ovt_fault_th[7]	ovt_fault_th[6]	ovt_fault_th[5]	ovt_fault_th[4]	ovt_fault_th[3]	ovt_fault_th[2]	ovt_fault_th[1]	ovt_fault_th[0]	0	0	0	0	0	0	0	0	0	0	0	0	0	0	0	0	0	0	0	0	0	0	0		
51	81	OT_WARN_LIMIT	RW	2	03FF	ovt_warn_th[7]	ovt_warn_th[6]	ovt_warn_th[5]	ovt_warn_th[4]	ovt_warn_th[3]	ovt_warn_th[2]	ovt_warn_th[1]	ovt_warn_th[0]	0	0	0	0	0	0	0	0	0	0	0	0	0	0	0	0	0	0	0	0	0	0	0		
57	87	VIN_OV_WARN_LIMIT	RW	2	03FF	ov_warn_th[7]	ov_warn_th[6]	ov_warn_th[5]	ov_warn_th[4]	ov_warn_th[3]	ov_warn_th[2]	ov_warn_th[1]	ov_warn_th[0]	0	0	0	0	0	0	0	0	0	0	0	0	0	0	0	0	0	0	0	0	0	0	0	0	
58	88	VIN_UV_WARN_LIMIT	RW	2	03FF	uv_warn_th[7]	uv_warn_th[6]	uv_warn_th[5]	uv_warn_th[4]	uv_warn_th[3]	uv_warn_th[2]	uv_warn_th[1]	uv_warn_th[0]	0	0	0	0	0	0	0	0	0	0	0	0	0	0	0	0	0	0	0	0	0	0	0	0	
59	89	VIN_UV_FAULT_LIMIT	RW	2	0	vin_uv_fault_th[7]	vin_uv_fault_th[6]	vin_uv_fault_th[5]	vin_uv_fault_th[4]	vin_uv_fault_th[3]	vin_uv_fault_th[2]	vin_uv_fault_th[1]	vin_uv_fault_th[0]	0	0	0	0	0	0	0	0	0	0	0	0	0	0	0	0	0	0	0	0	0	0	0	0	0
6B	107	PIN_OP_WARN_LIMIT	RW	2	FFFF	op_warn_th[7]	op_warn_th[6]	op_warn_th[5]	op_warn_th[4]	op_warn_th[3]	op_warn_th[2]	op_warn_th[1]	op_warn_th[0]	0	0	0	0	0	0	0	0	0	0	0	0	0	0	0	0	0	0	0	0	0	0	0	0	0
78	120	STATUS_BYTE	RO	1	0	0	OFF	0	IOUT_OC_FAULT	VIN_UV_FAULT	TEMPERATURE	CML	NOA	NOA	—	—	—	—	—	—	—	—	—	—	—	—	—	—	—	—	—	—	—	—	—	—	—	
79	121	STATUS_WORD	RO	2	0	0	OFF	0	IOUT_OC_FAULT	VIN_UV_FAULT	TEMPERATURE	CML	NOA	NOA	—	—	—	—	—	—	—	—	—	—	—	—	—	—	—	—	—	—	—	—	—	—	—	
7A	122	STATUS_VOUT	RO	1	0	VOUT_OV_FAULT	0	VOUT_UV_WARN	0	0	0	0	0	0	0	0	0	0	0	0	0	0	0	0	0	0	0	0	0	0	0	0	0	0	0	0	0	
7B	123	STATUS_IOUT	RO	1	0	IOUT_OC_FAULT	0	IOUT_OC_WARN	0	0	0	0	0	0	0	0	0	0	0	0	0	0	0	0	0	0	0	0	0	0	0	0	0	0	0	0	0	

Table 10. MAX16550A/MAX16550B PMBus Register Map (continued)

ADDRESS	DEC	NAME	TYPE	WIDTH	DEFAULT	LOW BYTE								HIGH BYTE												
						B7	B6	B5	B4	B3	B2	B1	B0	B15	B14	B13	B12	B11	B10	B9	B8					
7C	124	STATUS_INPUT	RO	1	0	VIN_OT_FAULT	0	VIN_UV_WARNING	0	IIN_OC_FAULT	0	IIN_OC_WARNING	0	PIN_OP_WARNING	0											
7D	125	STATUS_TEMPERATURE	RO	1	0	OT_FAULT	0	OT_WARNING	0	0	0	0	0	0	0											
7E	126	STATUS_CML	RO	1	0	invalid/un-supported cmd	0	PEC Failed	0	0	0	0	0	Other communication fault	0											
80	128	STATUS_MFR_SPECIFIC	RO	1	0	SELF_CHECK_FAULT	0	ROCP_FAULT	0	R_SMBUS_ID_FAULT	0	BST_UVLO_FAULT	0	0	0											
86	134	READ_EIN	BLK	7	0	8h06	0	engy_cnt[7:0]	roll_cnt[7:0]	samp_cnt[15:8]	0	samp_cnt[23:16]	0	0												vadc_ave[8]
88	136	READ_VIN	RO	2	0	vadc_ave[7]	0	vadc_ave[5]	vadc_ave[4]	vadc_ave[3]	vadc_ave[2]	vadc_ave[1]	vadc_ave[0]	0	0	0	0	0	0	0	0	0	0	0	0	vadc_ave[9]
89	137	READ_IIN	RO	2	0	iadc_ave[7]	0	iadc_ave[5]	iadc_ave[4]	iadc_ave[3]	iadc_ave[2]	iadc_ave[1]	iadc_ave[0]	0	0	0	0	0	0	0	0	0	0	0	0	iadc_ave[8]
8B	139	READ_VOUT	RO	2	0	vadc_ave[7]	0	vadc_ave[5]	vadc_ave[4]	vadc_ave[3]	vadc_ave[2]	vadc_ave[1]	vadc_ave[0]	0	0	0	0	0	0	0	0	0	0	0	0	vadc_ave[8]
8C	140	READ_IOUT	RO	2	0	iadc_ave[7]	0	iadc_ave[5]	iadc_ave[4]	iadc_ave[3]	iadc_ave[2]	iadc_ave[1]	iadc_ave[0]	0	0	0	0	0	0	0	0	0	0	0	0	iadc_ave[8]
8D	141	READ_TEMPERATURE	RO	2	0	iadc_ave[7]	0	iadc_ave[5]	iadc_ave[4]	iadc_ave[3]	iadc_ave[2]	iadc_ave[1]	iadc_ave[0]	0	0	0	0	0	0	0	0	0	0	0	0	iadc_ave[8]
97	151	READ_PIN	RO	2	0	pwr_calc[7]	0	pwr_calc[5]	pwr_calc[4]	pwr_calc[3]	pwr_calc[2]	pwr_calc[1]	pwr_calc[0]	0	0	0	0	0	0	0	0	0	0	0	0	pwr_calc[8]
98	152	PMBUS_REVISION	CN	1	22	0	0	1	0	0	0	1	0	0	0	0	0	0	0	0	0	0	0	0	0	pwr_calc[9]
99	153	MFR_ID	BLK	6	0	8h04	0	"A"	"X"	"I"	"M"															
9A	154	MFR_MODEL	BLK	6	0	8h05	0	1	6	5	0/1															
9B	155	MFR_REVISION	RO	1	2	0	0	0	0	0	0	mfr_rev[1]	mfr_rev[0]													

Table 10. MAX16550A/MAX16550B PMBus Register Map (continued)

ADDRESS	DEC	NAME	TYPE	WIDTH	DEFAULT	LOW BYTE							HIGH BYTE																			
						B7	B6	B5	B4	B3	B2	B1	B0	B15	B14	B13	B12	B11	B10	B9	B8											
D0	208	CONFIG	RW	2	0	ocp_clg cfgr[7]	mocp_cfrg[0]	0	0	0	vadc_peak[4]	vadc_peak[5]	0	0	0	vadc_peak[2]	vadc_peak[1]	num_aves_alarm[0]	num_aves_alarm[0]	ocp_severe_filter[0]	ocp_severe_filter[1]	0	0	0	0	0	0	0	pwrgd_cfrg[1]	pwrgd_cfrg[0]		
D1	209	PEAK_VIN	RO	2	0	vadc_peak[7]	vadc_peak[6]	vadc_peak[5]	vadc_peak[4]	vadc_peak[3]	vadc_peak[2]	vadc_peak[1]	vadc_peak[0]	vadc_peak[0]	vadc_peak[1]	vadc_peak[2]	vadc_peak[3]	vadc_peak[4]	vadc_peak[5]	vadc_peak[6]	vadc_peak[7]	0	0	0	0	0	0	vadc_peak[9]	vadc_peak[8]			
D2	210	PEAK_VOUT	RO	2	0	vadc_peak[7]	vadc_peak[6]	vadc_peak[5]	vadc_peak[4]	vadc_peak[3]	vadc_peak[2]	vadc_peak[1]	vadc_peak[0]	vadc_peak[0]	vadc_peak[1]	vadc_peak[2]	vadc_peak[3]	vadc_peak[4]	vadc_peak[5]	vadc_peak[6]	vadc_peak[7]	0	0	0	0	0	0	vadc_peak[9]	vadc_peak[8]			
D3	211	PEAK_PIN	RO	2	0	vadc_peak[7]	vadc_peak[6]	vadc_peak[5]	vadc_peak[4]	vadc_peak[3]	vadc_peak[2]	vadc_peak[1]	vadc_peak[0]	vadc_peak[0]	vadc_peak[1]	vadc_peak[2]	vadc_peak[3]	vadc_peak[4]	vadc_peak[5]	vadc_peak[6]	vadc_peak[7]	0	0	0	0	0	0	vadc_peak[9]	vadc_peak[8]			
D4	212	PEAK_TEMP	RO	2	0	vadc_peak[7]	vadc_peak[6]	vadc_peak[5]	vadc_peak[4]	vadc_peak[3]	vadc_peak[2]	vadc_peak[1]	vadc_peak[0]	vadc_peak[0]	vadc_peak[1]	vadc_peak[2]	vadc_peak[3]	vadc_peak[4]	vadc_peak[5]	vadc_peak[6]	vadc_peak[7]	0	0	0	0	0	0	vadc_peak[9]	vadc_peak[8]			
D5	213	CLEAR_PEAKS	WO	0	0	—	—	—	—	—	—	—	—	—	—	—	—	—	—	—	—	0	0	0	0	0	—	—	—	—		
D8	216	TRANS0	RO	1	0	0	trans0[6]	trans0[5]	trans0[4]	trans0[3]	trans0[2]	trans0[1]	trans0[0]	trans0[0]	trans0[1]	trans0[2]	trans0[3]	trans0[4]	trans0[5]	trans0[6]	0	0	0	0	0	0	0	—	—	—	—	
D9	217	TRANS1	RO	1	0	0	trans1[6]	trans1[5]	trans1[4]	trans1[3]	trans1[2]	trans1[1]	trans1[0]	trans1[0]	trans1[1]	trans1[2]	trans1[3]	trans1[4]	trans1[5]	trans1[6]	0	0	0	0	0	0	0	—	—	—	—	
DA	218	TRANS2	RO	1	0	0	trans2[6]	trans2[5]	trans2[4]	trans2[3]	trans2[2]	trans2[1]	trans2[0]	trans2[0]	trans2[1]	trans2[2]	trans2[3]	trans2[4]	trans2[5]	trans2[6]	0	0	0	0	0	0	0	—	—	—	—	
DB	219	TRANS3	RO	1	0	0	trans3[6]	trans3[5]	trans3[4]	trans3[3]	trans3[2]	trans3[1]	trans3[0]	trans3[0]	trans3[1]	trans3[2]	trans3[3]	trans3[4]	trans3[5]	trans3[6]	0	0	0	0	0	0	0	—	—	—	—	
DC	220	TRANS4	RO	1	0	0	trans4[6]	trans4[5]	trans4[4]	trans4[3]	trans4[2]	trans4[1]	trans4[0]	trans4[0]	trans4[1]	trans4[2]	trans4[3]	trans4[4]	trans4[5]	trans4[6]	0	0	0	0	0	0	0	—	—	—	—	
DD	221	CONFIG_2	RW	2	0	0	0	0	0	num_aves_reporting[3]	num_aves_reporting[2]	num_aves_reporting[1]	num_aves_reporting[0]	num_aves_reporting[0]	num_aves_reporting[1]	num_aves_reporting[2]	num_aves_reporting[3]	hyst[4]	hyst[5]	hyst[6]	hyst[7]	0	0	0	0	0	0	0	0	0		
F2	242	HYST_LOW	RW	2	03FF	hyst[7]	hyst[6]	hyst[5]	hyst[4]	hyst[3]	hyst[2]	hyst[1]	hyst[0]	hyst[0]	hyst[1]	hyst[2]	hyst[3]	hyst[4]	hyst[5]	hyst[6]	hyst[7]	0	0	0	0	0	0	0	0	0		
F3	243	HYST_HIGH	RW	2	03FF	hyst[7]	hyst[6]	hyst[5]	hyst[4]	hyst[3]	hyst[2]	hyst[1]	hyst[0]	hyst[0]	hyst[1]	hyst[2]	hyst[3]	hyst[4]	hyst[5]	hyst[6]	hyst[7]	0	0	0	0	0	0	0	0	0		
F4	244	HYST_STATUS	RO	1	0	0	0	0	0	0	0	0	0	0	0	0	0	0	0	0	0	0	0	0	0	0	0	0	0	0		
F5	245	PIN_OP_FAULT_LIMIT	RW	2	5540	pin_op_fault<7>	pin_op_fault<6>	pin_op_fault<5>	pin_op_fault<4>	pin_op_fault<3>	pin_op_fault<2>	pin_op_fault<1>	pin_op_fault<0>	pin_op_fault<0>	pin_op_fault<1>	pin_op_fault<2>	pin_op_fault<3>	pin_op_fault<4>	pin_op_fault<5>	pin_op_fault<6>	pin_op_fault<7>	0	0	0	0	0	0	0	0	0	0	0
FD	253	PEAK_VOUT	RO	2	0	vout_peak[7]	vout_peak[6]	vout_peak[5]	vout_peak[4]	vout_peak[3]	vout_peak[2]	vout_peak[1]	vout_peak[0]	vout_peak[0]	vout_peak[1]	vout_peak[2]	vout_peak[3]	vout_peak[4]	vout_peak[5]	vout_peak[6]	vout_peak[7]	0	0	0	0	0	0	0	0	0	0	



**CONFIG Register (D0h)**

This is a 2-byte register used to configure the ICs. The default value is 0000h. The meaning of the bits of this register are shown in [Table 11](#).

**CONFIG\_2 Register (DDh)**

This single-byte register allows the selection of the number of samples to average for voltage, current and power reporting. Only bits 3:0 are used; bits 7:4 have no

effect and should be left as 0000b. The meaning of the bits of this register are shown in [Table 12](#).

**Peak Voltage, Current, and Power Reporting**

The 2-byte registers shown in [Table 13](#) provides readings of the peak values for input voltage, output current, input power, and temperature in 10 bits direct format.

These registers can be reset with the CLEAR\_PEAKS command (send byte D5h) or power cycling the part.

**Table 11. CONFIG Register (D0h)**

BIT NO.	BIT NAME	SETTINGS	DESCRIPTION
[15:14]	Ocp_severe_filter[1:0]		Severe OCP deglitch time
		0	10µs (default value)
		1	100µs
		10	no digital deglitch
[13]	I-ADC disable	0	I-ADC Enabled (default value)
		1	I-ADC Disabled
[12:11]	ss_cfg[1:0]	0	Soft-Start Delay = 2.5ms (default value)
		1	Soft-Start Delay = 12.5ms
		10	Soft-Start Delay = 22.6ms
		11	22.5ms
[10]	Not Used	0	—
		1	—
[9:8]	pwrzd_th[1:0] (Notes 3, 4)	0	Power-Good Threshold = 11V, Self-Check Threshold = 9V
		1	Power-Good Threshold = 10V, Self-Check Threshold = 8V
		10	Power-Good Threshold = 9V, Self-Check Threshold = 7V
		11	Power-Good Threshold = 8V, Self-Check Threshold = 6V
[7]	ocp_cfg	0	Severe OCP = 1.3x moderate OCP (default value)
		1	Severe OCP = 1.7x moderate OCP
[6:5]	mocc_cfg[1:0]	0	Moderate OCP timeout = 100µs (default value)
		1	Moderate OCP timeout = 250ms
		10	Moderate OCP timeout = 100ms
		11	Moderate OCP timeout = 12.5µs
[4]	Not Used		
[1:0]	num_aves_alert[1:0]	0	Sets Averaging for PMBus Warning Levels to 1 Sample (default value)
		1	Sets Averaging for PMBus Warning Levels to 2 Samples
		10	Sets Averaging for PMBus Warning Levels to 4 Samples
		11	Sets Averaging for PMBus Warning Levels to 8 Samples

MAX16550A  
MAX16550B

Integrated Protection IC on 12V Bus with an  
Integrated MOSFET, Lossless Current Sensing,  
and PMBus Interface

**Table 12. Averaging Sample Size Settings Using Register DDh**

<b>BITS #</b>	<b>SETTING</b>	<b>NUMBER OF SAMPLES USED FOR REPORTING AVERAGING FOR VOLTAGE, CURRENT AND POWER</b>
[3:0]	0	1 sample
	1	2 samples
	10	4 samples
	11	8 samples
	100	16 samples
	101	32 samples
	110	64 samples
	111	128 samples
	1000	256 samples
	1001	512 samples
	1010	1024 samples
	1011	2048 samples
	1100	4096 samples
	1101	8192 samples
	1110	16384 samples
1111	32768 samples	

### PMBus Reporting

For readings other than direct readings (e.g., Registers D1h, D2h, D3h, D4h, and FDh) PMBus specifications specify that the actual readings in their respective units correlate with the numerical values read from registers, as shown in Equation 14.

- Current/Voltage/Temperature: 10-bit resolution
- Power: 16-bit resolution

#### Equation 14:

$$X = \frac{1}{m}(Y \times 10^{-R} - b)$$

where:

X = Calculated, “real world” value in the appropriate units (A, V, °C, etc.)

m = Slope coefficient (a 2-byte, two’s complement integer)

Y = 2-byte two’s complement integer received from the PMBus device

b = Offset (a 2-byte, two’s complement integer)

R = Exponent (a 1-byte, two’s complement integer)

The values used in the ICs for the parameters above are shown in [Table 14](#). Note that current and power readings depend on the value of R<sub>LOAD</sub>, the external current reporting resistor.

**Table 13. Manufacturer-Specific Direct Reporting Registers**

REGISTER ADDRESS	REGISTER NAME	PARAMETER
D1h	PEAK_VIN	Peak Input Voltage
D2h	PEAK_IOUT	Peak Output Current
D3h	PEAK_PIN	Peak Input Power
D4h	PEAK_TEMP	Peak Temperature
FDh	PEAK_VOUT	Peak Output Voltage

**Table 14. PMBus Equation Parameters**

PMBUS REGISTER	FORMAT	DATA BYTES	m	b	R	UNITS
READ_IOUT (8Ch)*, READ_IIN (89h)*	Direct	2	3.824 x R <sub>LOAD</sub>	-4300	-3	A
READ_VOUT (8Bh), READ_VIN (88h)	Direct	2	7578	0	-2	V
READ_TEMPERATURE_1 (8Dh)	Direct	2	199	7046	-2	°C
READ_PIN (97h)	Direct	2	0.895 x R <sub>LOAD</sub>	-9100	-2	W
READ_EIN (86h)**	Direct	2	3.505 x R <sub>LOAD</sub>	0	-5	**

### Input Capacitance (C<sub>IN</sub>) Selection

Use of input capacitors is highly recommended to guarantee the input voltage is stable and noise free. For applications requiring no input capacitors before the protection IC, the input-voltage ripple should be less than 300mV peak-to-peak.

### Output Capacitance (C<sub>OUT</sub>) selection

The maximum output capacitance can be calculated as shown in Equation 15.

Equation 15:

$$C_{OUT} = \frac{(I_{INRUSH} \times C_{SS})}{I_{SS}}$$

where:

C<sub>SS</sub> = Soft-start programming capacitance.

I<sub>SS</sub> = Soft-start current, 30μA (typ).

C<sub>OUT</sub> = Maximum load capacitance that can be used at soft-start with a purely capacitive load.

I<sub>INRUSH</sub> = Desired maximum inrush current during startup. Select I<sub>INRUSH</sub> lower than startup OCP (I<sub>OCP(STARTUP)</sub>) and within startup SOA, refer to [Figure 1](#).

### Design Example

Assume a design value for maximum inrush current of 10A, and a soft-start capacitance of 25nF.

Assume 12V application and 30μA (typ) soft-start current; soft-start time in this case is 0.01ms. The maximum safe operating output current is 11A at 0.01ms (refer to the Startup SOA in [Figure 1](#)) and the Startup OCP level is 8A.

The designed maximum inrush current of 5A is lower than 8A Startup OCP and within Startup SOA. The designed value is valid. Hence, the maximum load capacitance is calculated as shown in Equation 16.

Equation 16:

$$C_{OUT} = \frac{(5A \times 25nF)}{30\mu A} = 4.17mF$$

### Input TVS Diode Selection

The use of a transient voltage suppression (TVS) diode at input is necessary to clamp input-voltage transient within rating of the V<sub>IN</sub> pin (see the [Absolute Maximum Ratings](#) section).

A general guide to select the proper TVS diode is listed below:

- Choose TVS diode reverse-standoff voltage (V<sub>RWM</sub>) ≥ operating voltage of 12V (typ).
- Choose TVS diode peak-pulse current (I<sub>PPM</sub>) ≥ maximum transient peak-pulse current of 30A (typ).
- Choose TVS clamping voltage (V<sub>C</sub>) ≤ maximum voltage-handling capability of 22V (typ) for 150μs.

Recommend SMCJ13A based on selection criteria above.

### Output Schottky Diode Selection

The use of a Schottky diode at output is necessary to clamp the negative output-voltage spike within the rating of the V<sub>OUT</sub> pin (see the [Absolute Maximum Ratings](#) section). Select the proper Schottky diode with low forward-voltage drop (V<sub>F</sub>) and peak forward-surge current (I<sub>FSM</sub>) higher than the expected inductive current.

**Table 15. R<sub>OCP</sub> and R<sub>ILOAD</sub> Selection**

PART	R <sub>OCP</sub>	R <sub>ILOAD</sub>
MAX16550A/MAX16550B (30A)	97kΩ	8.2kΩ

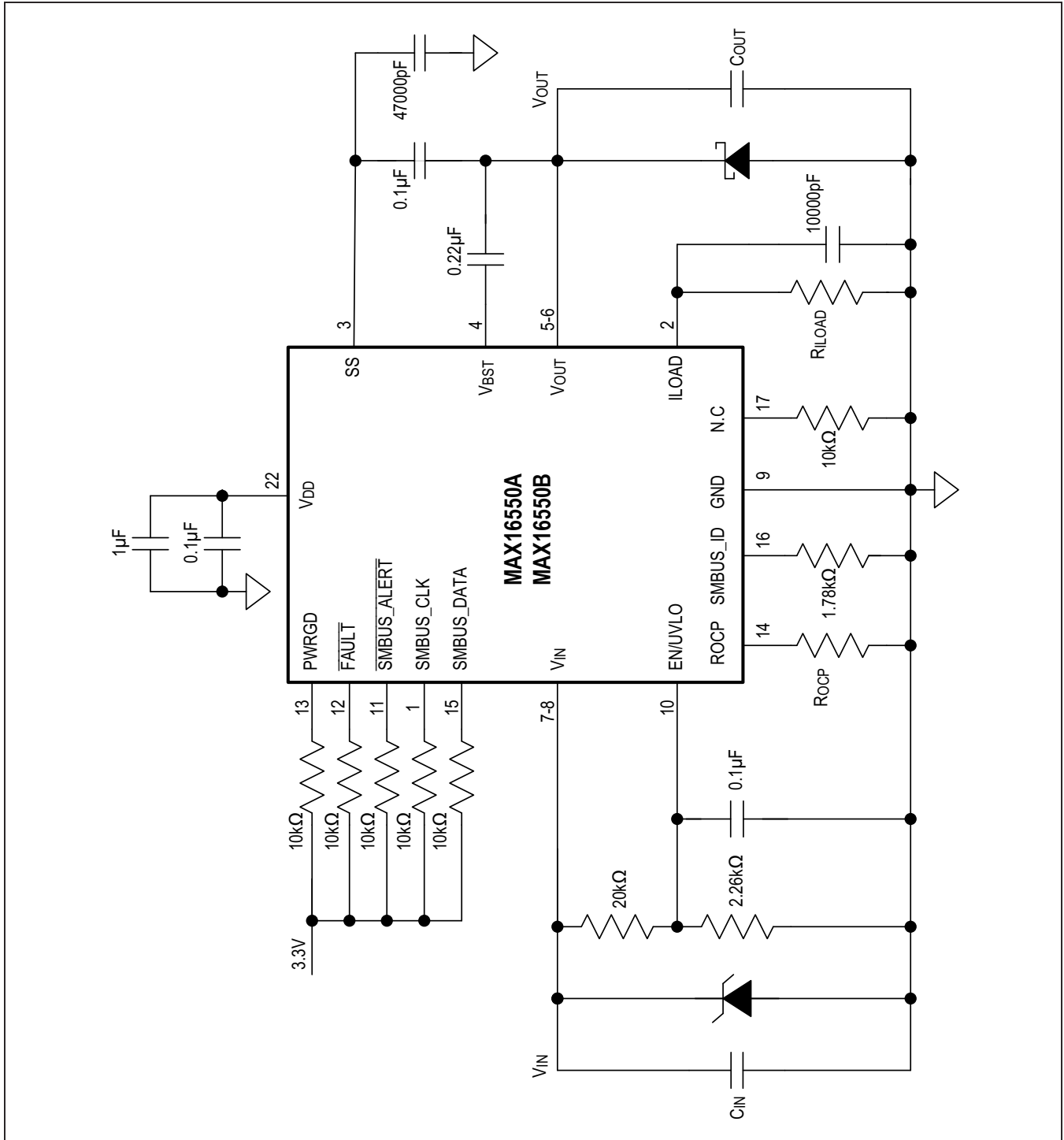

Figure 6. Reference Schematic

## Layout Recommendations

### $V_{IN}$ and $V_{OUT}$

- Minimize input and output trace inductance by using wide and multiple  $V_{IN}$  and  $V_{OUT}$  planes for optimal thermal performance.
- Use multiple vias to connect interlaying power planes.
- Place input capacitors (where applicable) as close to the IC as possible.
- Place output capacitors as close to the IC as possible.
- Place TVS and Schottky diodes close to the IC for tighter coupling to  $V_{OUT}$ , and GND;  $V_{IN}$ , and GND.

### Example

The EV kit layout in [Figure 7](#) shows use of large, wide power planes for  $V_{IN}$  and  $V_{OUT}$  on the top layer.  $C_{IN}$  and  $C_{OUT}$  are close to the IC. The other  $V_{IN}$  and  $V_{OUT}$  power layers are connected with multiple vias between the pins.

### Ground

- Use a trace approximately 1mm wide by 7mm long from the ground pin (pin 13) on the top layer to the underlying ground layers through at least two vias.
- Use a keepout to eliminate all metals directly under the IC package on the second layer.

### Example

The EV kit layout in [Figure 8](#) and [9](#) show the appropriate ground connection with vias and the ground keepout on Layer 2 (ground). The keepout should extend approximately 30mils outside the IC package.

### $V_{BST}$ and SS

Place the  $V_{BST}$  and SS capacitors on the top layer as close to the pins as possible.

### $V_{DD}$

- Add a  $V_{DD}$  plane on the top layer to decouple the  $V_{DD}$  caps close to the IC to form a tighter loop to ground.
- Place  $V_{DD}$  ground far away from the output capacitor ground.

### ROCP and ILOAD

The ROCP and ILOAD resistors should be placed as close to the IC as possible.

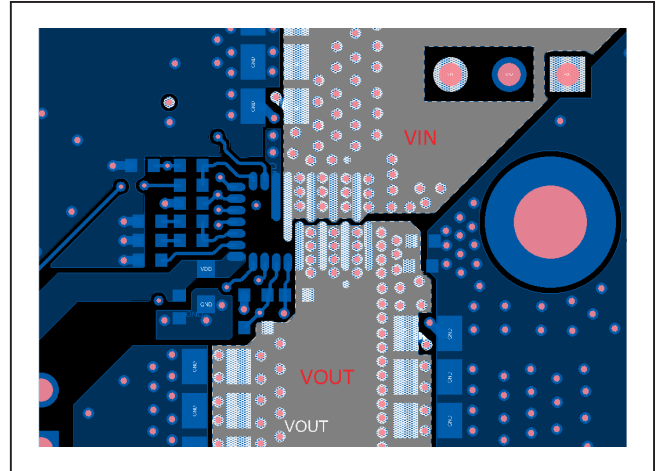

Figure 7. Top Layer (Power)

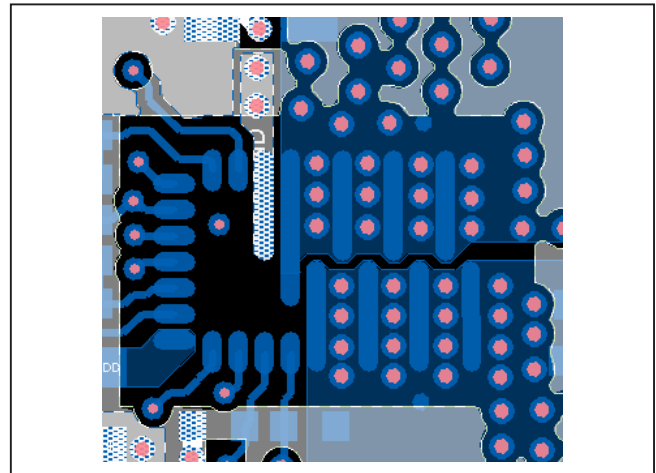

Figure 8. Top Layer (Power) and Layer 2 (GND) with Keepout

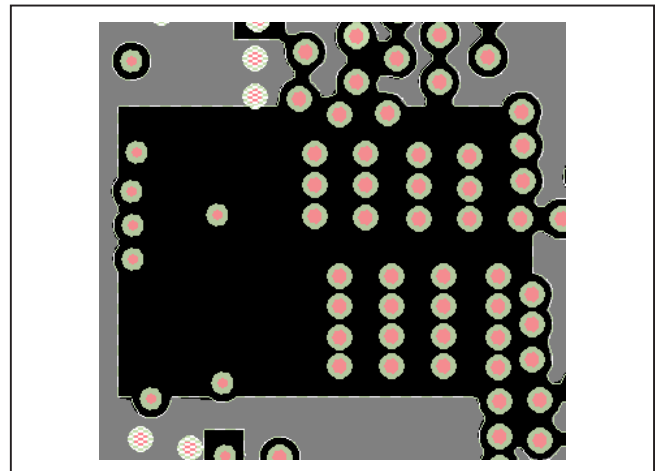

Figure 9. Second Layer (GND) with Keepout

MAX16550A  
MAX16550B

Integrated Protection IC on 12V Bus with an  
Integrated MOSFET, Lossless Current Sensing,  
and PMBus Interface

### Ordering Information

PART	DESCRIPTION	PACKAGE	PACKAGE MARKING
<b>MAX16550AGPN+</b>	Overcurrent Protection Startup OCP = 8A	18 FCQFN	MAX16550A
MAX16550AGPN+T			
<b>MAX16550BGPN+</b>	Overcurrent Protection Startup OCP = 16A Overvoltage Protection Disabled	18 FCQFN	MAX16550B
MAX16550BGPN+T			

+Denotes lead(Pb)-free/RoHS-compliant part.

T = Tape and reel.

MAX16550A  
MAX16550B

Integrated Protection IC on 12V Bus with an  
Integrated MOSFET, Lossless Current Sensing,  
and PMBus Interface

## Revision History

REVISION NUMBER	REVISION DATE	DESCRIPTION	PAGES CHANGED
0	10/17	Initial release	—
1	12/17	Updated the <i>Ordering Information</i> table	41
2	11/18	Added MAX16550B to data sheet title and throughout document, updated <i>Electrical Characteristics</i> table, corrected several minor errors and incorrect table references	1–41
3	11/18	Corrected table and figure references. Improved Figure 1	16, 18, 21, 38
4	6/19	Remove MAX16551A part number, and add note to MAX16550B as “future product.”	All
5	10/19	Removed “future product” note for MAX16550B. Corrected Startup Delay values. Implemented consistent current-hysteresis threshold command names. Corrected FOLLOWER_FAULT bit in STATUS_MFR_SPECIFIC. Corrected Equation 6 description and result of Equation 11.	5, 19, 20, 27-29, 31-33, 39

For pricing, delivery, and ordering information, please visit Maxim Integrated's online storefront at <https://www.maximintegrated.com/en/storefront/storefront.html>.

Maxim Integrated cannot assume responsibility for use of any circuitry other than circuitry entirely embodied in a Maxim Integrated product. No circuit patent licenses are implied. Maxim Integrated reserves the right to change the circuitry and specifications without notice at any time. The parametric values (min and max limits) shown in the *Electrical Characteristics* table are guaranteed. Other parametric values quoted in this data sheet are provided for guidance.



# Mouser Electronics

Authorized Distributor

Click to View Pricing, Inventory, Delivery & Lifecycle Information:

[Maxim Integrated:](#)

[MAX16550AGPN+](#) [MAX16550BGPN+](#) [MAX16550AGPN+T](#)