

SMD Power Inductor CDRH125



Description

- Ferrite drum core construction.
- Magnetically shielded.
- L × W × H: 12.3 × 12.3 × 6.0 mm Max.
- Product weight: 2.9g(Ref.)
- Moisture Sensitivity Level: 1
- RoHS compliance.

Environmental Data

- Operating temperature range: -40°C ~ +100°C (including coil's self temperature rise)
- Storage temperature range: -40°C ~ +100°C
- Solder reflow temperature: 260 °C peak.

Packaging

- Carrier tape and reel packaging
- 13" diameter reel
- 500pcs per reel

Applications

- Ideally used in Notebook PC, LCD TV, DVD, Game machine, STB, Projector etc. as DC-DC converter inductors.

Dimension - [mm]

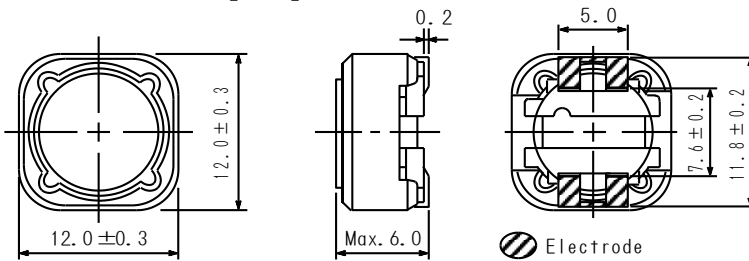

Land pattern and Schematics - [mm]

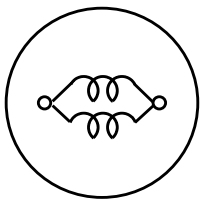
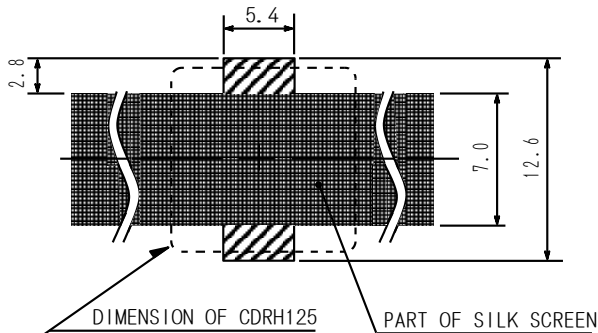

1.3µH ~ 47µH

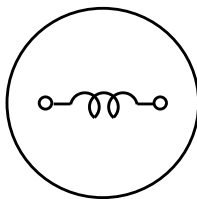

56µH ~ 1mH

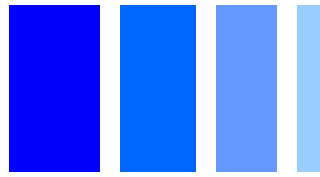

Electrical Characteristics

PART NO.	STAMP	INDUCTANCE [WITHIN] ※1	D.C.R. (Ω) (at 20°C) MAX.(TYP.)	SATURATION CURRENT (A)※2 MAX.(TYP.)	TEMPERATURE RISE CURRENT (A)※3
CDRH125NP-100MC	100	10 μ H \pm 20%	25m(19m)	5.48(6.85)	5.60
CDRH125NP-120MC	120	12 μ H \pm 20%	27m(21m)	4.88(6.10)	5.20
CDRH125NP-150MC	150	15 μ H \pm 20%	30m(23m)	4.48(5.60)	5.00
CDRH125NP-180MC	180	18 μ H \pm 20%	34m(26m)	4.24(5.30)	4.50
CDRH125NP-220MC	220	22 μ H \pm 20%	36m(28m)	3.84(4.80)	4.25
CDRH125NP-270MC	270	27 μ H \pm 20%	51m(39m)	3.40(4.25)	3.50
CDRH125NP-330MC	330	33 μ H \pm 20%	57m(44m)	3.08(3.85)	2.95
CDRH125NP-390MC	390	39 μ H \pm 20%	68m(52m)	2.80(3.50)	2.90
CDRH125NP-470MC	470	47 μ H \pm 20%	75m(58m)	2.44(3.05)	2.80
CDRH125NP-560MC	560	56 μ H \pm 20%	0.11(84m)	2.34(2.92)	2.70
CDRH125NP-680MC	680	68 μ H \pm 20%	0.12(93m)	2.16(2.70)	2.55
CDRH125NP-820MC	820	82 μ H \pm 20%	0.14(0.11)	1.80(2.25)	2.50
CDRH125NP-101MC	101	100 μ H \pm 20%	0.16(0.12)	1.72(2.15)	2.28
CDRH125NP-121MC	121	120 μ H \pm 20%	0.17(0.13)	1.49(1.86)	2.05
CDRH125NP-151MC	151	150 μ H \pm 20%	0.23(0.18)	1.36(1.70)	1.80
CDRH125NP-181MC	181	180 μ H \pm 20%	0.29(0.22)	1.30(1.62)	1.75
CDRH125NP-221MC	221	220 μ H \pm 20%	0.40(0.31)	1.16(1.45)	1.56
CDRH125NP-271MC	271	270 μ H \pm 20%	0.46(0.35)	1.06(1.32)	1.38
CDRH125NP-331MC	331	330 μ H \pm 20%	0.51(0.39)	0.96(1.20)	1.25
CDRH125NP-391MC	391	390 μ H \pm 20%	0.69(0.53)	0.86(1.08)	1.20
CDRH125NP-471MC	471	470 μ H \pm 20%	0.77(0.59)	0.76(0.95)	1.05
CDRH125NP-561MC	561	560 μ H \pm 20%	0.86(0.66)	0.70(0.88)	0.90
CDRH125NP-681MC	681	680 μ H \pm 20%	1.20(0.92)	0.66(0.82)	0.80
CDRH125NP-821MC	821	820 μ H \pm 20%	1.34(1.03)	0.59(0.74)	0.72
CDRH125NP-102MC	102	1.0mH \pm 20%	1.53(1.18)	0.52(0.65)	0.66

※1 Measured frequency L at 1 kHz

※2 Saturation current: This indicates the value of D.C. current when the inductance becomes 25% lower than it's initial value. (Ta=20°C).

※3 Temperature rise current :The actual value of D.C. current when the temperature of coil becomes $\Delta T=40^\circ C$ (Ta=20°C).

SMD Power Inductor CDRH125



Saturation Current & Temperature Rise Graph

— L (20°C) — L (100°C) — ΔT

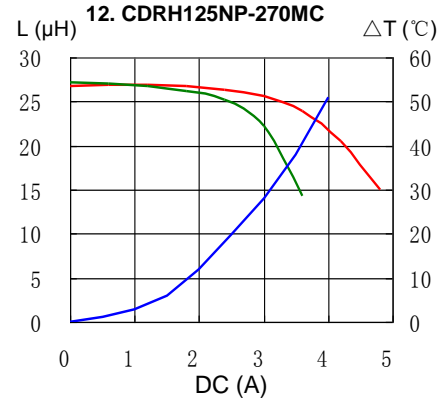
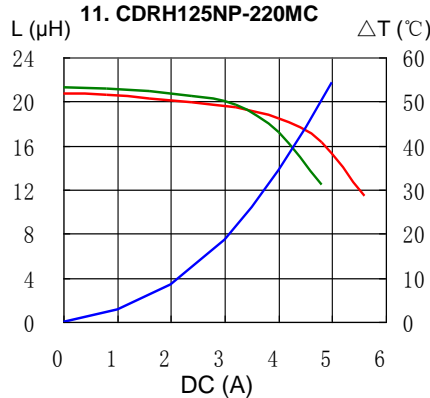
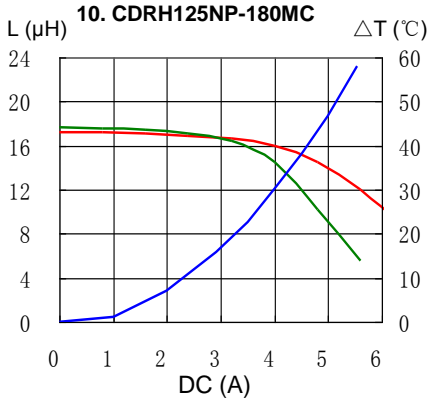
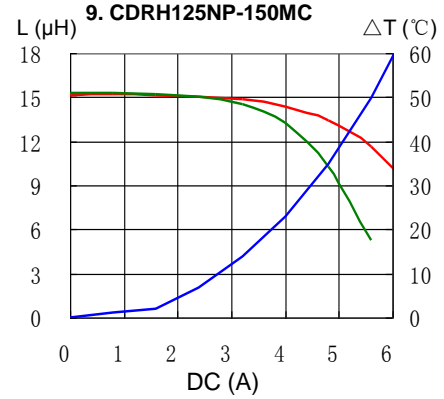
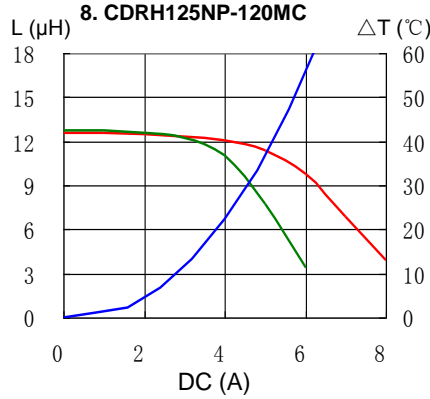
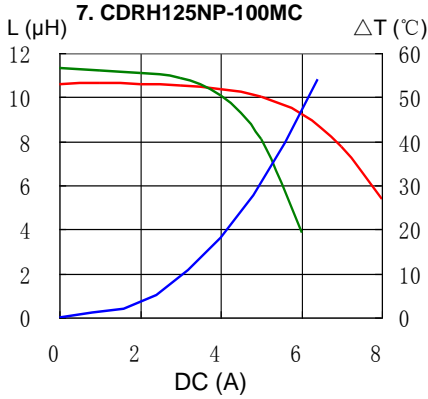
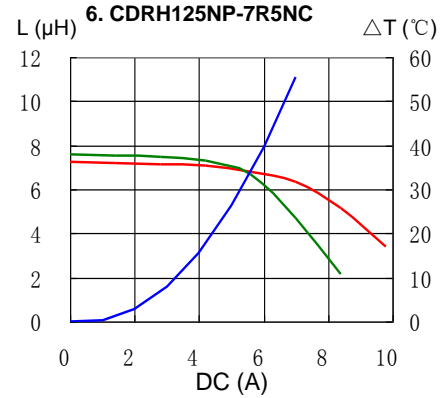
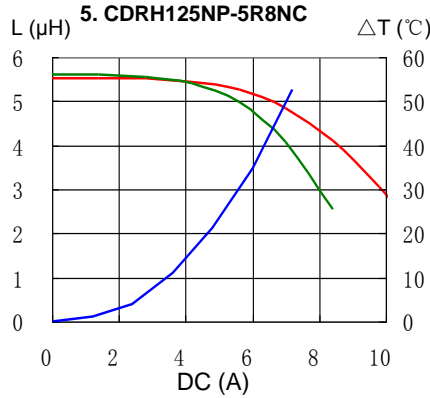
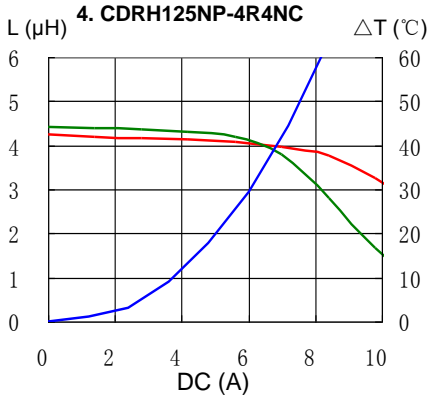
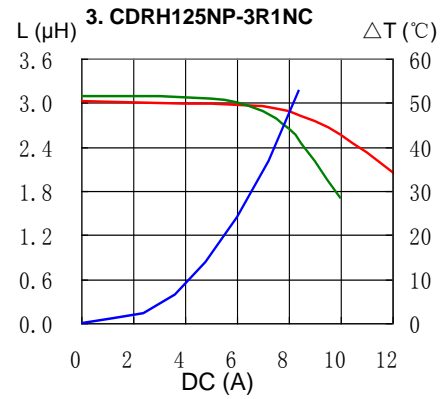
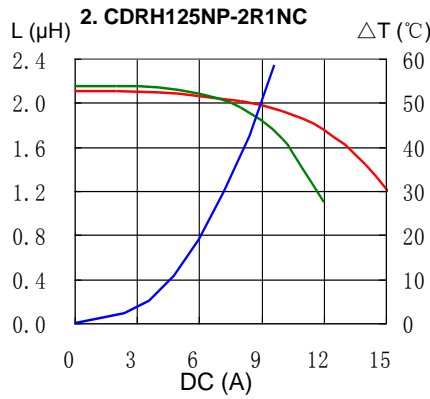
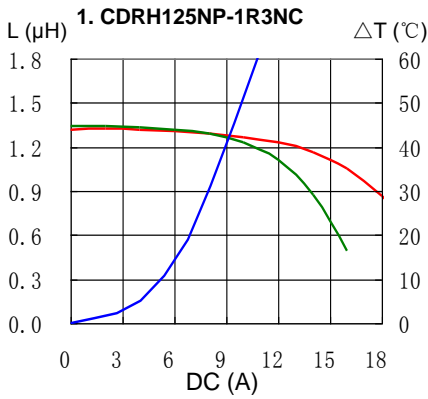

SMD Power Inductor CDRH125



Saturation Current & Temperature Rise Graph

— L (20°C) — L (100°C) — ΔT

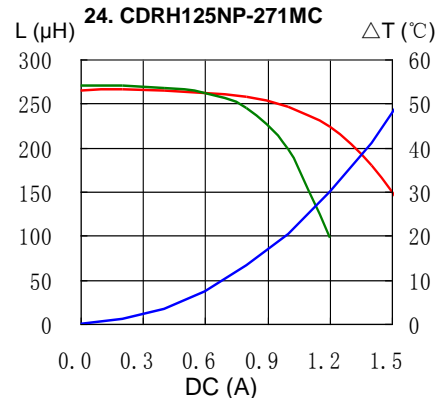
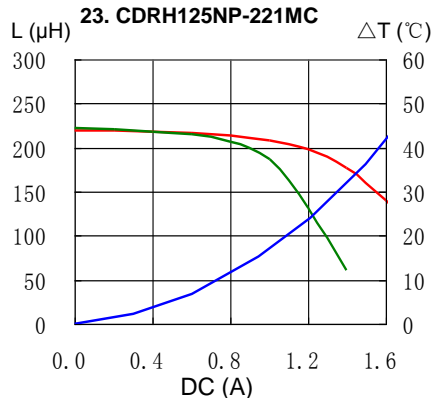
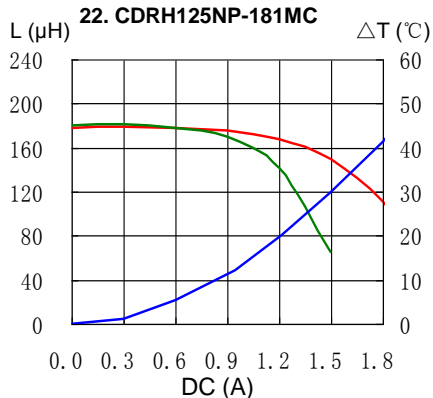
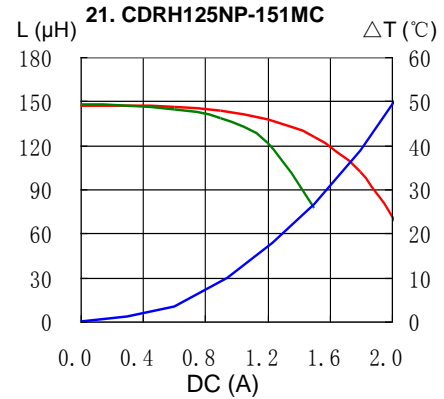
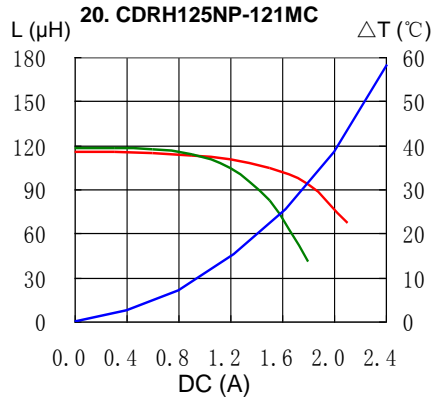
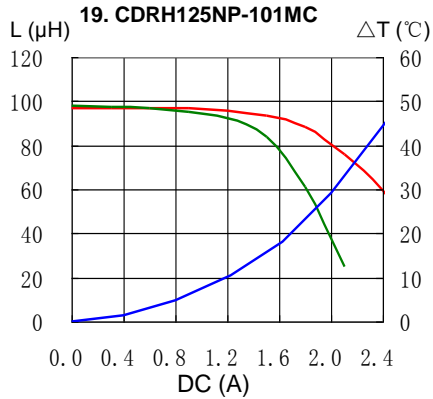
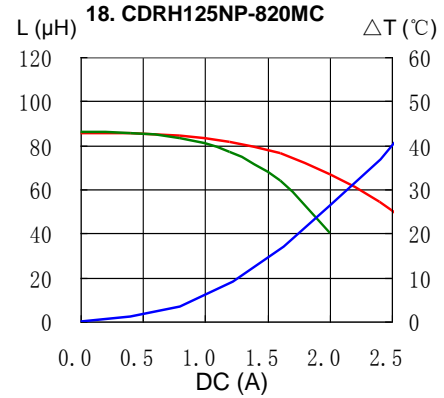
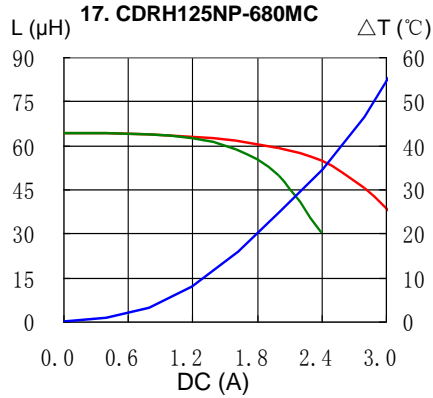
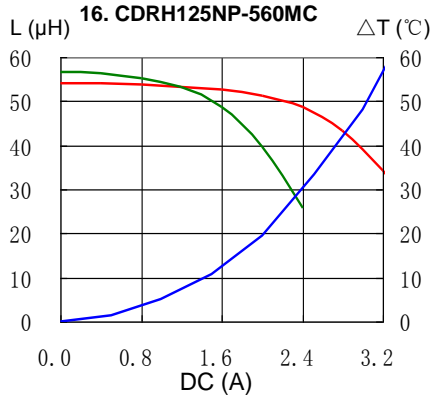
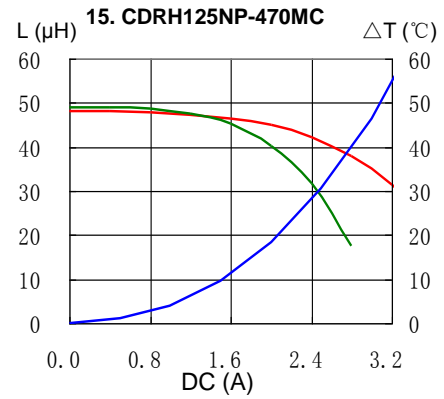
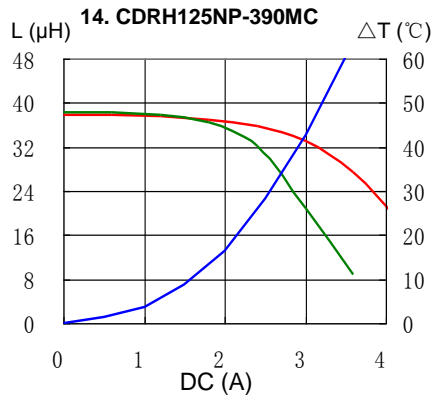
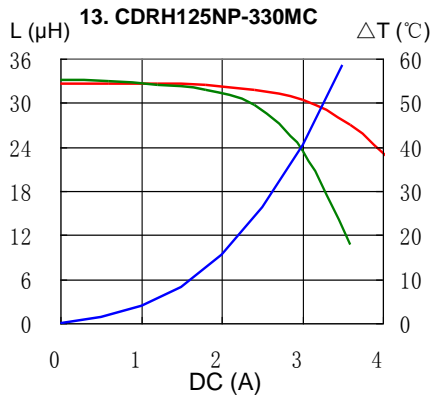

SMD Power Inductor CDRH125



Saturation Current & Temperature Rise Graph

— L (20°C) — L (100°C) — ΔT

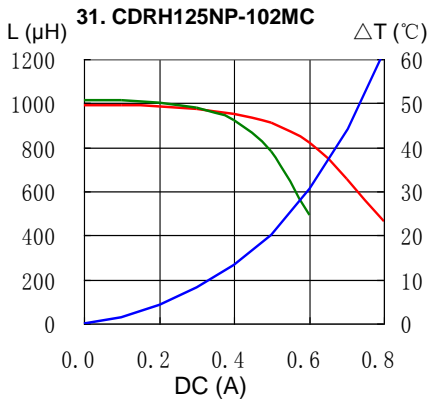
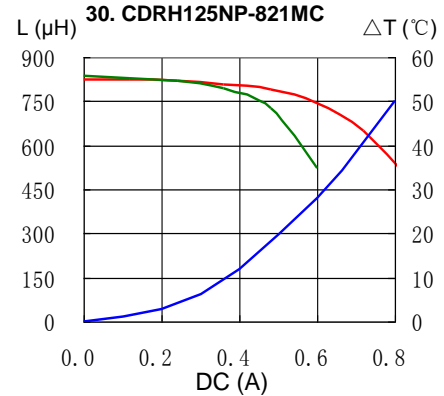
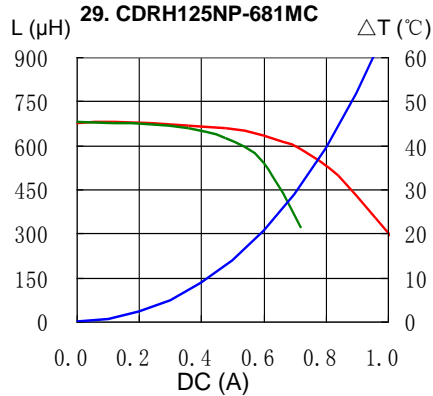
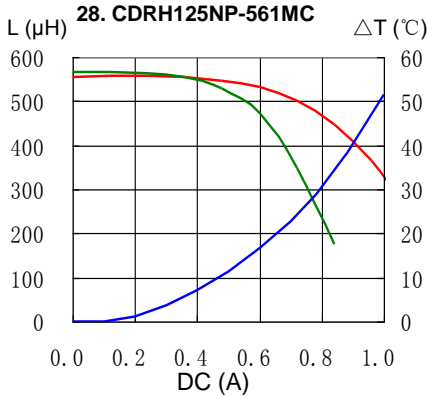
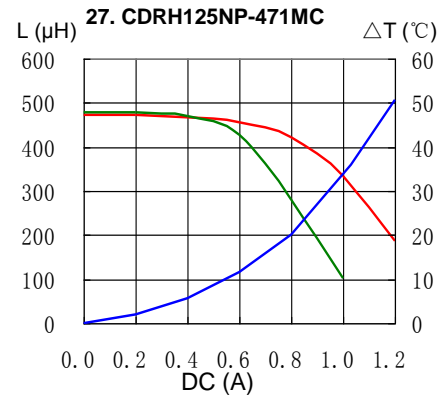
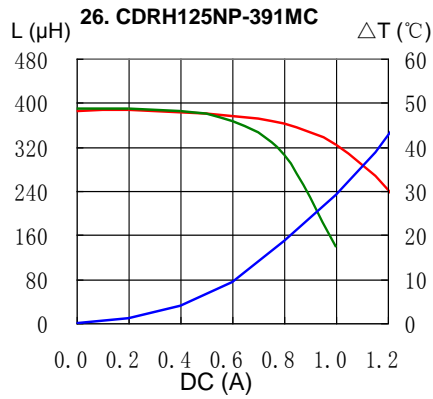
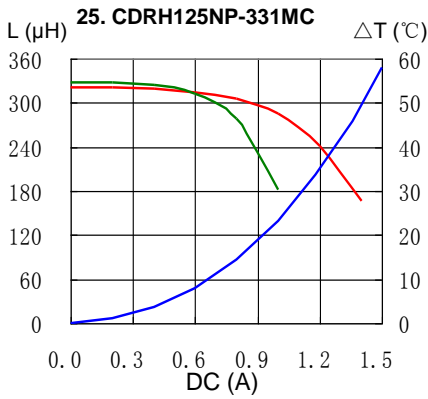

SMD Power Inductor CDRH125

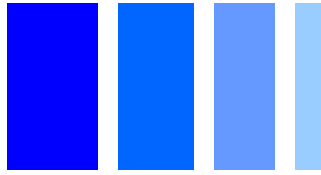

Solder Reflow Condition

Heat Endurance

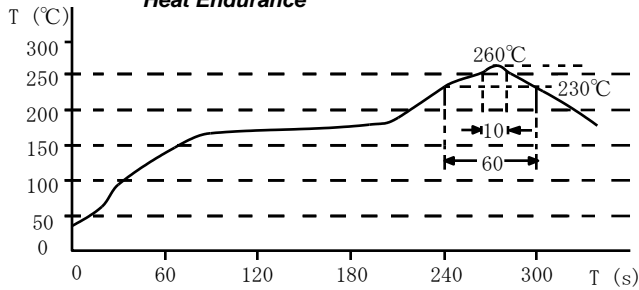

Temperature Chart

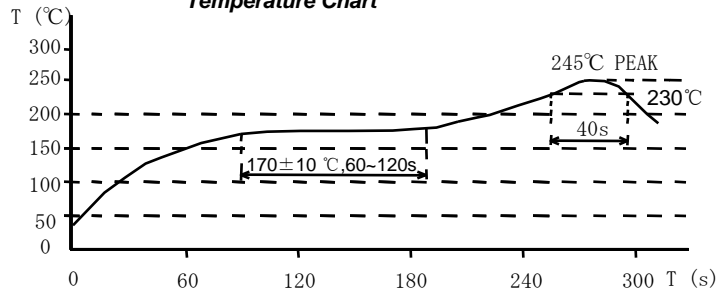

Please refer to the sales offices on our website - <http://www.sumida.com>

Hong Kong

Tel.+852-2880-6781
FAX.+852-2565-9600
sales@hk.sumida.com

Saitama(Japan)

Tel.+81-48-691-7300
FAX.+81-48-691-7340
sales@jp.sumida.com

Chicago

Tel.+1-847-545-6700
FAX. +1-847-545-6720
sales@us.sumida.com

Shanghai

Tel.+86-21-5836-3299
FAX.+86-21-5836-3266
shanghai.sales@cn.sumida.com

Seoul

Tel.+82-2-6237-0777
FAX.+82-2-6237-0778
sales@kr.sumida.com

Obernzell

Tel.+49-8591-937-0
FAX. +49-8591-937-103
contact@eu.sumida.com

Shenzhen

Tel.+86-755-8291-0228
FAX.+86-755-8291-0338
shenzhen.sales@cn.sumida.com

Singapore

Tel.+65-6296-3388
FAX.+65-6841-4426
sales@sg.sumida.com

Neumarkt

Tel.+49-9181-4509-110
FAX. +49-9181-4509-310
infocomp@eu.sumida.com

Taipei

Tel.+886-2-8751-2737
FAX.+886-2-8751-2738
sales@tw.sumida.com

San Jose

Tel.+1-408-321-9660
FAX.+1-408-321-9308
sales@us.sumida.com

Mouser Electronics

Authorized Distributor

Click to View Pricing, Inventory, Delivery & Lifecycle Information:

Sumida:

[CDRH125NP-5R8NC](#) [CDRH125NP-100MC](#) [CDRH125NP-150MC](#) [CDRH125NP-180MC](#) [CDRH125NP-220MC](#)
[CDRH125NP-330MC](#) [CDRH125NP-390MC](#) [CDRH125NP-470MC](#) [CDRH125NP-560MC](#) [CDRH125NP-680MC](#)
[CDRH125NP-820MC](#) [CDRH125NP-101MC](#) [CDRH125NP-121MC](#) [CDRH125NP-151MC](#) [CDRH125NP-221MC](#)
[CDRH125NP-102MC](#) [CDRH125NP-3R1NC](#) [CDRH125NP-7R5NC](#) [CDRH125NP-391MC](#) [CDRH125NP-1R3NC](#)
[CDRH125NP-681MC](#) [CDRH125NP-270MC](#) [CDRH125NP-821MC](#) [CDRH125NP-271MC](#) [CDRH125NP-4R4NC](#)
[CDRH125NP-471MC](#) [CDRH125NP-120MC](#) [CDRH125NP-561MC](#) [CDRH125NP-331MC](#) [CDRH125NP-181MC](#)