

LOC	DIST	REVISIONS					
E	B	P	LTR	DESCRIPTION	DATE	DWN	APVD
			BA	NEW RELEASE	03-FEB-10	MRS	St.P

FOR FURTHER INFORMATION SEE DATA SHEET FOR
 CRG SERIES-THICK FILM CHIP RESISTORS

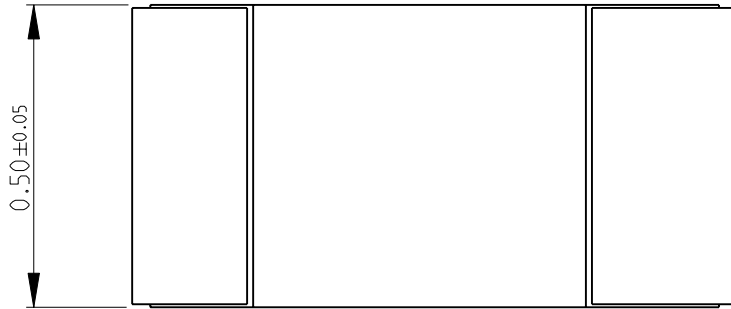

RoHS Compliant



2010

RELEASED FOR PUBLICATION

THIS DRAWING IS UNPUBLISHED.

BY TYCO ELECTRONICS CORPORATION. ALL RIGHTS RESERVED.

© COPYRIGHT 2010

DIMENSIONS: mm	DWN MAHARUDRA	03-FEB-10	MATERIAL	-	FINISH	-
	CHK ALLAN.P	03-FEB-10	 Tyco Electronics Corporation Dorcan, Swindon, SN3 5HH			
TOLERANCES UNLESS OTHERWISE SPECIFIED:	APVD STEPHEN.P	03-FEB-10				
0 PLC ±0.5	PRODUCT SPEC	-	NAME THICK FILM CHIP RESISTORS SERIES CRG 0402			
1 PLC ±0.2	APPLICATION SPEC	-	SIZE	CAGE CODE	DRAWING NO	RESTRICTED TO
2 PLC ±0.1			A 4	00779	© = 1676480	-
3 PLC ±-	WEIGHT	-	CUSTOMER DRAWING			
4 PLC ±-			SCALE	80:1	SHEET	1 OF 1
ANGLES ±5°			REV BA			

Mouser Electronics

Authorized Distributor

Click to View Pricing, Inventory, Delivery & Lifecycle Information:

[TE Connectivity:](#)

[CRG0402F10K](#)