

TEST SOLUTIONS

FULL PRODUCT LINE



### YAMAICHI ELECTRONICS FACTS & FIGURES

Foundation:	Headquarters, Tokyo: 1956 European Headquarter, Aschheim near Munich: 1986
Turnover:	Worldwide 230 m € p.a., Europe 75 m € p.a.
Employees:	Over 2,100, in Europe 285
Certification:	DIN EN ISO 9001:2015 (HQ and production EU) ISO 14001:2015 (production in Frankfurt/Oder) ISO/TS 16949 (selected production sites)
Locations:	Worldwide 7 production sites, 6 design centers, 13 sales locations

as of May 2018

### YAMAICHI ELECTRONICS ZAHLEN & FAKTEN

Firmengründung:	Konzernsitz, Tokyo: 1956 Europäische Zentrale, Aschheim bei München: 1986
Umsatz:	weltweit 230 Mio € p.a., Europa 75 Mio € p.a.
Mitarbeiter:	über 2.100 weltweit, 285 in Europa
Zertifizierung:	DIN EN ISO 9001:2015 (HQ und Produktion EU) ISO 14001:2015 (Produktion in Frankfurt/Oder) ISO/TS 16949 (ausgewählte Produktionsstandorte)
Standorte:	weltweit 7 Produktionsstandorte, 6 Design-Zentren, 13 Vertriebszentren

Stand: Mai 2018

## PRODUCT RANGE

Yamaichi Electronics designs, manufactures and markets high performance interconnection devices, also for use in the most demanding applications of electronic systems: with high temperature environments, protected interconnections for harsh environments and high-speed interconnections for data networking applications. The portfolio covers high precision fine pitch IC sockets, connectors, cable assemblies and flexible printed circuits.

## YAMAICHI EUROPE

Yamaichi Electronics Deutschland GmbH, located in Aschheim near Munich, is your European partner for connectivity solutions covering Industrial, Automotive, Measurement & Testing, Data Networking, Medical and Embedded & Semiconductor applications.

### Two Divisions:

**Connector Solutions:** Portfolio: Connectors for Industrial use, for example circular connectors Y-Circ® M (M12) and Y-Circ® P (Push-Pull), Y-Con® Series (RJ45 and USB). Automotive connectors FAKRA/HSD, Quadlock (Y-QUAD) and others, card connectors, high speed connector systems and latest input /output connectors. Internal connectors for high end applications (Y-Lock® series). Data networking connectors, cables and cable assemblies as well as production sockets.

**Test Solutions:** Portfolio: IC semiconductor test & burn-in sockets, modular test contactors, test adapter systems for computer-on-modules, receptacles, spring probe pins, PCB design.

**In all product areas we offer customer specific solutions.**

## ENGINEERING

Two design centers in Munich (Germany) and Sousse (Tunisia) react quickly to market challenges and work with the most modern technologies for the realisation of customer needs from product ideas to qualified mass production. Two fully equipped inhouse test laboratories allow internal product qualification and guarantee convincing product quality.

## PRODUCTION FOR THE EUROPEAN MARKET

In our production facility in Frankfurt (Oder) we have been manufacturing connectors and complex cable assemblies for e.g. industrial or medical applications since 2006. In the area of test solutions we produce high end test contactors, module test adapters and receptacles. We offer special know-how in overmolding, welding, resistance welding and machining technologies. To ensure highest quality and short delivery times we have a high grade of vertical range of manufacturing and established a reliable European supplier network.

## LEISTUNGSSPEKTRUM

Yamaichi Electronics entwickelt, produziert und vermarktet hochleistungsfähige elektromechanische Komponenten, auch für anspruchsvollste Anwendungen in elektronischen Systemen: für den Hochtemperaturbereich, geschützt für den Einsatz unter rauen Umgebungsbedingungen und High Speed Verbindungstechnik für Daten networking Anwendungen. Das Portfolio umfasst hochpräzise Fine pitch IC Sockel, Steckverbinder, Kabelassemblierungen und flexible Leiterplatten.

## YAMAICHI EUROPA

Yamaichi Electronics Deutschland GmbH, mit Sitz in Aschheim bei München, ist Ihr europäischer Ansprechpartner für Verbindungstechnik. Lösungen für Applikationen in: Automatisierung, Automotive, Meß- und Prüftechnik, Data Networking, Medizintechnik und Halbleiterindustrie.

### Zwei Bereiche:

**Connector Solutions:** Portfolio: Industriesteckverbinder, z.B. Rundsteckverbinder Y-Circ® M (M12) und Y-Circ® P (Push-Pull), Y-Con® (RJ45 and USB). Automotive Steckverbinder FAKRA/ HSD, Quadlock (Y-QUAD) und andere spezielle Automotive Lösungen, Kartensteckverbinder, High Speed Steckverbinder systeme und neueste Input /Output Steckverbinder. Interne Steckverbinder für High End Applikationen (Y-Lock® Serie). Data Networking Steckverbinder, Kabel und Kabelassemblierungen, Produktionssockel.

**Test Solutions:** Portfolio: IC Halbleiter Test & Burn-In Sockel, modulare Test Contactoren, Test Adapter Systeme für Computer-on-Modules, Receptacles, Federkontaktstifte, PCB Design.

**In allen Produktbereichen bieten wir kundenspezifische Lösungen an.**

## ENGINEERING

Mit zwei Design-Zentren in München und Sousse (Tunesien) ist die schnelle Reaktion auf Marktanforderungen und Kundenwünsche sichergestellt. Unser Entwicklungsteam arbeitet mit den modernsten Technologien zur Realisierung von Kundenanforderungen. Umfangreich ausgestattete hauseigene Testlabore ermöglichen die interne Qualifizierung von Produkten und gewährleisten überzeugende Produktqualität.

## PRODUKTION FÜR DEN EUROPÄISCHEN MARKT

An unserem Fertigungstandort in Frankfurt (Oder) werden seit 2006 Steckverbinder und komplexe Kabelassemblierungen für z.B. Industrie- oder Medizinanwendungen hergestellt. Im Bereich Test Solutions werden High End Test Contactors, Modultestadapter und Receptacles gefertigt. Wir bieten Spezial-Know How in den Fertigungstechnologien Spritzguss, Schweißen, Widerstandsschweißen und Zerspanungstechnik. Die hohe Fertigungstiefe sowie in Europa ansässige zuverlässige Zulieferfirmen garantieren hochwertige Produkte und kurze Lieferzeiten.

**INTERFACE SOLUTIONS**

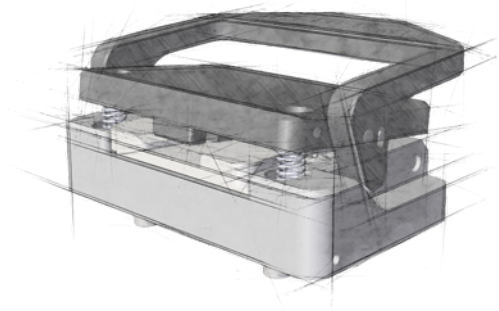

**Automotive-Test Adapter**  
Overview .....76

**Qseven-Test Adapter**  
Overview .....77

**ComExpress -Test Adapter**  
Overview .....78

**DIMM / SODIMM -Test Adapter**  
Overview .....79

**Smarc Test Adapter**  
Overview.....80

**FPC / FFC Clip Connector**  
LC and YED900 Series..... 92 - 93

**Dockings**..... 92 - 93

**Specials** ..... 92 - 93

**CONTACTING - SEMICONDUCTOR**

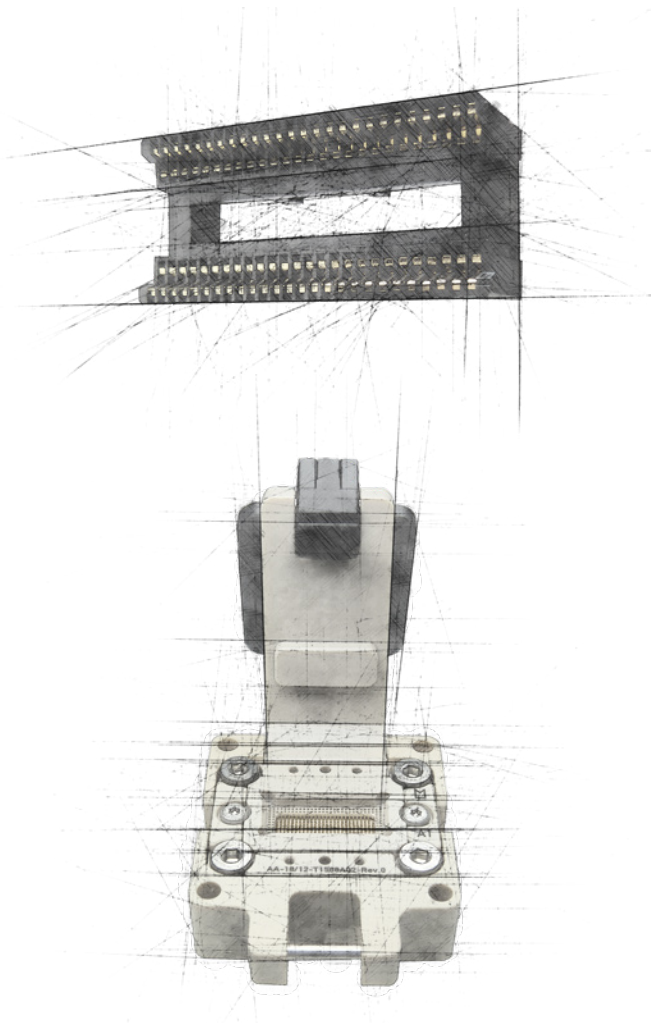

**Pin Through Hole Devices**

SIP (Single Inline Package)  
1.27 to 2.0mm pitch, with dual wipe contacts.....10

ZIP (Zig-Zag Inline Package)  
1.27 to 1.778mm pitch, with dual wipe contacts .....11

DIP / SDIP (Dual Inline Package)  
2.54mm pitch, for P-DIP and side braze packages.....12  
Shrink 1.778mm pitch, for HD mounting (SDIP) .....13  
Shrink 1.778mm pitch, plus piggy-back option (SDIP).....14

**SMT Devices**

SOJ (Small Outline J-Leads)  
1.27mm pitch, dead-bug and live-bug insertion.....18 - 19

PLCC (Plastic Lead Chip Carrier)  
1.27mm pitch, clamshell .....20  
1.27mm pitch, open top .....21

SOP (\*Small Outline Packages, Gullwing Leads)  
Overview..... 22 - 23  
Applicable dimensions:  
0.4 to 0.5mm pitch..... 24  
0.55 / 0.6 / 0.635 / 0.65 / 0.8 mm pitch..... 25  
1.00 / 1.25 / 1.27mm pitch..... 26 - 27

QFP (\*Quad Flat Packages, Gullwing Leads)  
Overview..... 28 - 29  
Applicable dimensions:  
0.4 to 0.5mm pitch ..... 30 - 31  
0.635 and 0.65mm pitch.....32  
0.8 to 1.0mm pitch..... 33 - 34

LCC (Non-Leaded Devices)  
1.016 and 1.27mm pitch, TH clamshell socket for LCC..... 35

**CONTACTING - SEMICONDUCTOR**

**BGA / CSP / LGA (Ball and Pad Arrays)**

Overview..... 36 - 38  
 Applicable dimensions:  
 0.4 / 0.5 / 0.65 / 0.75mm pitch ..... 39 - 40  
 0.8mm pitch..... 41 - 42  
 1.00 to 1.27mm pitch..... 43 - 45  
 Base sockets and full grid sizes for NP276..... 46 - 47

**QFN (Quad Flat Non-Leaded)**

Overview..... 48 - 49  
 Contact Types..... 50  
 Applicable dimensions: 0.4 / 0.5 / 0.65 / 0.80mm pitch ..... 51 - 54

**Universal Socket Concept for BGA, CSP, QFN, LGA, SON**

Overview and Series IC561, IC564, NP584, IC530, IC567, IC542..... 55 - 61

**Test Contactors - SERIES YED274**

Customised >0.30mm BGA / CSP / QFN / LGA / QFP / SO..... 64 - 67

**Test Contactors - SERIES YED254**

Customised >0.30mm BGA / CSP / QFN / LGA / QFP / SO..... 64 - 67

**Test Contactor - SERIES Y-RED Modular**

Overview, Hinged Type and Volume Test, Product Range..... 68 - 69

**Receptacles**

Socket Adapters..... 70 - 71

**Spring Probe Pins**

Overview ..... 72 - 73

**PCB SOLUTIONS**

**PCB SOLUTIONS**

Overview ..... 96  
 Design Examples..... 97

**CONTACTING - MODULES**

**Memory Modules**

**DIMM (Dual Inline Memory Module)**

72 Pins..... 81  
 144 Pins..... 82  
 168 Pins..... 83  
 184 and 240 pins..... 84  
 184 Pins..... 85  
 144, 172 and 200 Pins..... 86

**SIMM (Single Inline Memory Module)**

1.27 and 2.54mm pitch, 4 to 100 pins..... 87 - 88

**Card Edge Connectors**

2.54mm pitch, 180° TH - 40 and 120 pins..... 89  
 2.54mm pitch, 180° TH - 28 to 100 pins..... 90  
 3.96mm pitch, 180° TH - 36 to 88 pins..... 91

**REFERENCE PAGES**

General Terms of Agreement ..... back pages  
 Part Number Index ..... back pages  
 Worldwide addresses ..... back pages

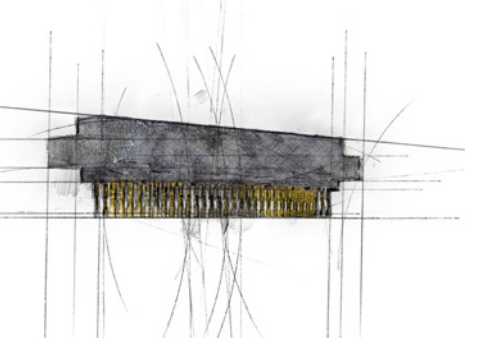
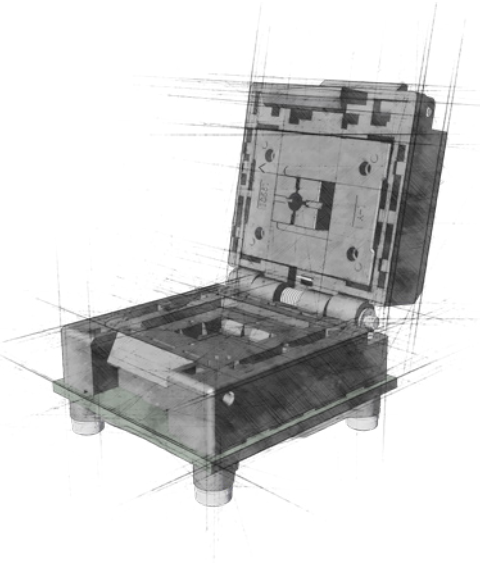

# INTERFACE SOLUTIONS

An adapter board acts as a mechanical and electrical interface between the tester (ATE) and the device under test (DUT). The range of such an adaption can vary from very simple to quite complex where it has well-defined physical dimensions and it must fit perfectly into the tester environment.

A properly designed adapter board is electronically “invisible”, and does not introduce any distortion or delay to the DUT signals. The adapter board should be able to support all the tests executed on the tester and be flexible enough to support future testing.

Yamaichi Electronics adapter boards are impedance controlled and able to deal with critical signals up to the higher Giga Hertz range. Onboard measurement capabilities and a contact clearance down to 0.3mm complete this solution.

Automotive - Test Adapter .....	76
Qseven - Test Adapter .....	77
ComExpress - Test Adapter .....	78
DIMM / SODIMM - Test Adapter .....	79
Smarc - Test Adapter .....	80
FPC / FFC Clip Connector .....	92 - 93
Dockings .....	92 - 93
Specials .....	92 - 93



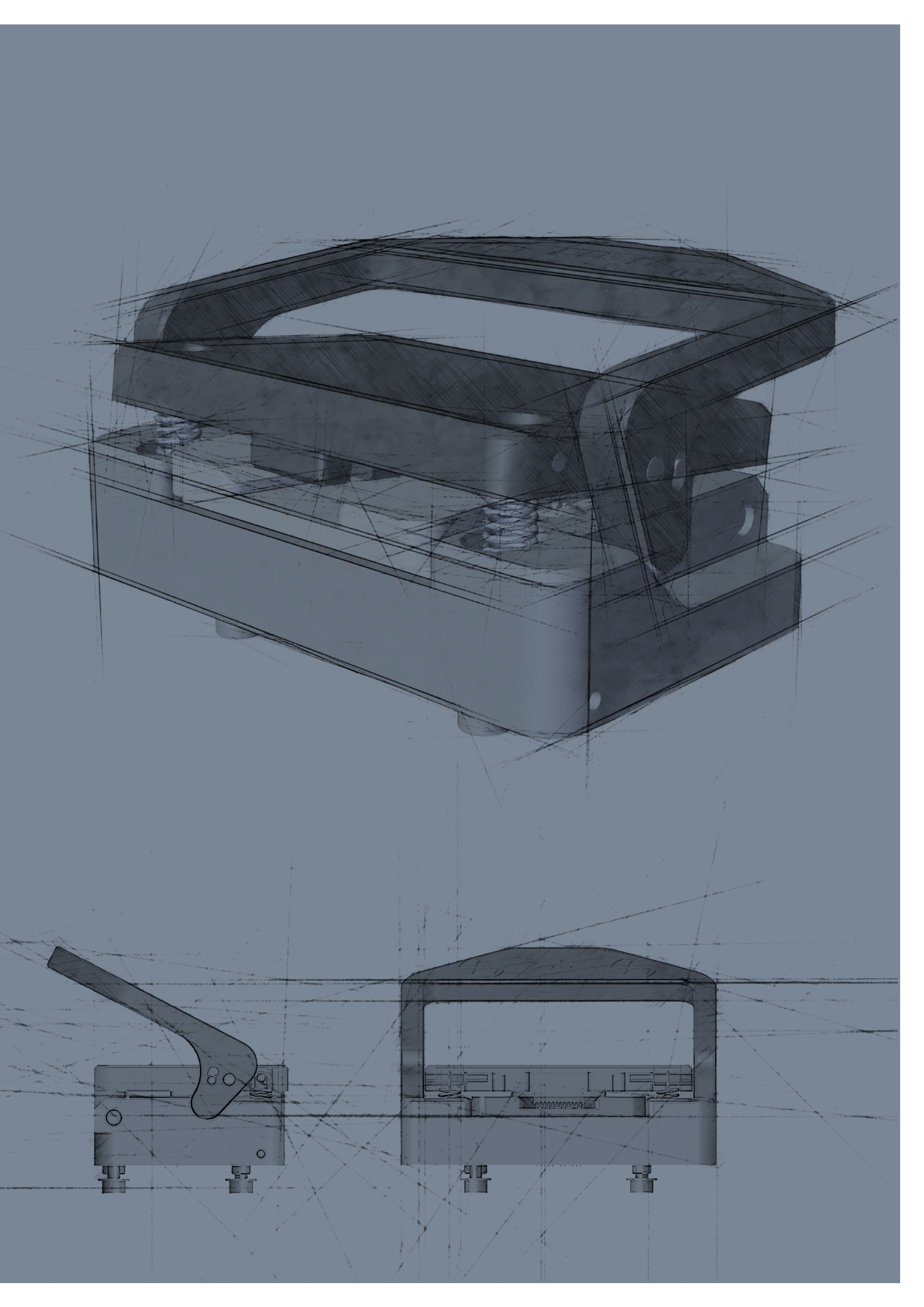

With sophisticated and customized designs Yamaichi Electronics provides test adapter systems for high speed signal test of industry and automotive computer-on-modules. Superior and reliable contact design ensures high speed signal integrity.

Our product range includes vertical and horizontal test adapters for burn-in, functional testing and flashing. The applicable industry module standards are SMARC, COM Express, Qseven, SO-DIMM and DIMM.

Yamaichi Electronics have also developed solutions for the entire manufacturing process with our Unique Test and Flash Adapter

The advantages of the test adapter systems:

Maximum yield in testing and flashing | Reduced testing effort | Less testing costs per module

**SPECIFICATIONS**

Operating temp. : up to +85°C  
 Pitch: 0.5mm  
 Mating Cycles: 50,000 (expected)  
 (mechanical contact cycles at room temperature depending on customer environmental conditions)  
 Flex/Rigid: Impedance Controlled layerstack architecture according customer requirements

**PART NUMBER**

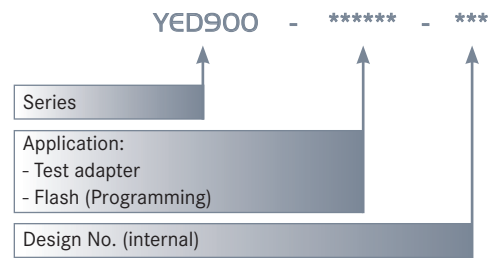

**MATERIALS AND FINISH**

Housing: Peek / Anodized Aluminium  
 Contacts: Beryllium Copper / Gold Plated over Nickel  
 Flex/Rigid: Epoxy/Polymid, Multilayer  
 Contact Pad Surface: Hard Gold

**FEATURES**

- Performance controlled system acc. to customised pin out
- Flexible in module size
- Sensor for correct module insertion
- Automated cycle counting using customised firmware software
- Applications: Functional testing, Burn-In and Programming

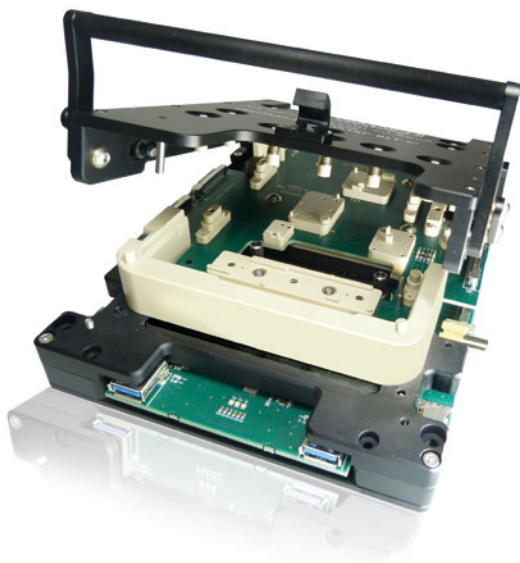
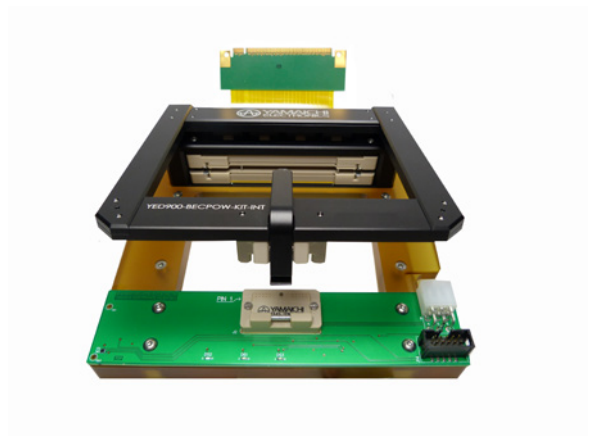



**SPECIFICATIONS**

Operating Temp. : -up to +85°C  
 Pitch: 0.5mm  
 Mating Cycles: Up to 50,000 times (mechanical contact cycles at room temperature depending on customer environmental conditions)  
 Flex/Rigid: Impedance Controlled Layerstack architecture according to Qseven

**MATERIALS AND FINISH**

Housing: Peek / Anodized Aluminium  
 Contacts: Beryllium Copper / Gold Plated over Nickel  
 Flex/Rigid: Epoxy/Polymid, Multilayer  
 Contact Pad Surface: Hard Gold

**FEATURES**

- Performance controlled system acc. to Qseven
- Compatible to MXM Connector / Board Edge Connector 230 Pins (BEC)
- Flexible in module size
- In-line volume test
- Volume test ready
- Serial number

**PART NUMBER**

YED900 - 230230 - N - Q7 - \*\*\*

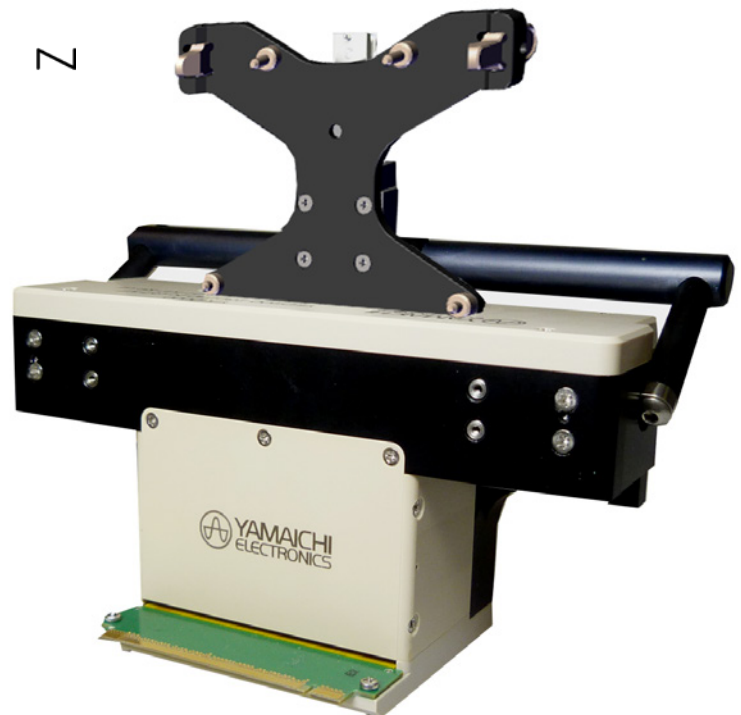
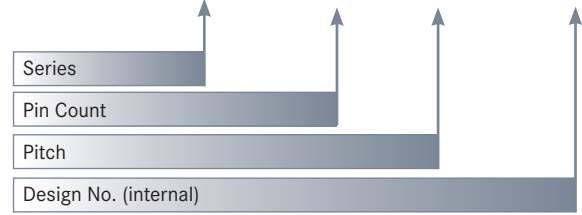

**SPECIFICATIONS**

Operating Temp. : up to +85°C  
 Pitch: 0.5mm  
 Mating Cycles: 50,000 (expected)  
 (mechanical contact cycles at room temperature depending on customer environmental conditions)

**MATERIALS AND FINISH**

Housing: Peek / Anodized Aluminium  
 Contacts: Beryllium Copper / Gold Plated over Nickel  
 Flex/Rigid: Epoxy/Polymid, Multilayer  
 Contact Pad Surface: Hard Gold

**FEATURES**

- Reliable Probe Pin Technology
- Compatible to ComExpress standards
- Flexible in module size
- In-line volume test
- Volume test ready
- Other Computer-on-Module Test Systems on request
- Serial number

**PART NUMBER**

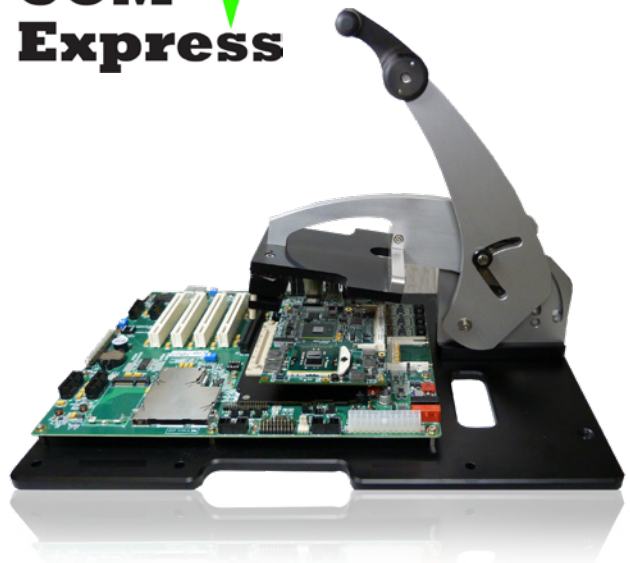
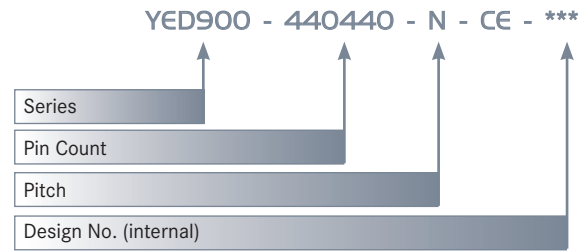

Open position

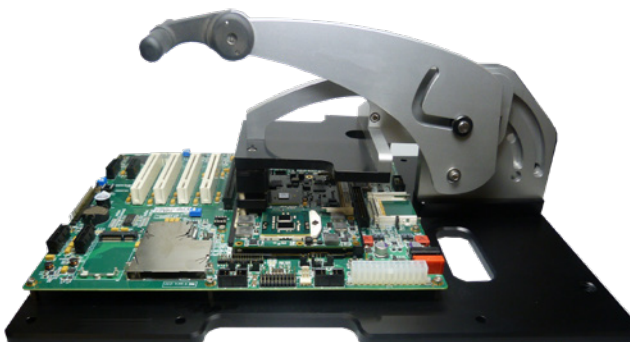

Closed position

**SPECIFICATIONS**

Operating Temp. : up to +85°C  
 Pitch: ≥ 0.5mm  
 Mating Cycles: 50,000 (expected)  
 (mechanical contact cycles at room temperature depending on customer environmental conditions)

**PART NUMBER**

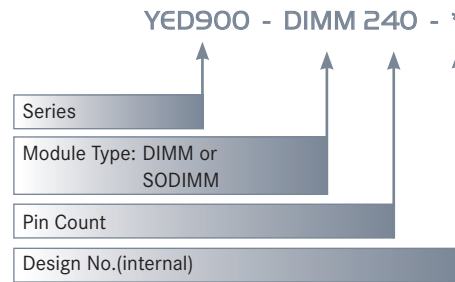

**MATERIALS AND FINISH**

Housing: Peek / Anodized Aluminium  
 Contacts: Beryllium Copper / Gold Plated over Nickel  
 Flex/Rigid: Epoxy/Polymid, Multilayer  
 Contact Pad Surface: Hard Gold

**FEATURES**

- Performance controlled system
- Compatible to DIMM / SODIMM standards
- In-line volume test
- Volume test ready
- Serial number



**SPECIFICATIONS**

Operating temp. : up to +85°C  
 Pitch: 0.5mm  
 Mating Cycles: 50,000 (expected)  
 (mechanical contact cycles at room temperature depending on customer environmental conditions)  
 Flex/Rigid: Impedance Controlled layerstack architecture according customer requirements

**PART NUMBER**

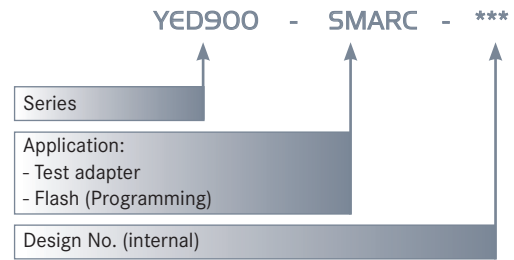

**MATERIALS AND FINISH**

Housing: Peek / Anodized Aluminium  
 Contacts: Beryllium Copper / Gold Plated over Nickel  
 Flex/Rigid: Epoxy/Polymid, Multilayer  
 Contact Pad Surface: Hard Gold

**FEATURES**

**Smart Mobility ARChitecture**

- Performance controlled system acc. to SGeT SMARC specifications
- Durable and highly reliable contact system
- Volume test ready - increases output
- Easy and secure operation
- Reduced cost per tested module



**SPECIFICATIONS**

Contact Resistance: <50mΩ  
 Contact Force: ~30g (typical)  
 Operating Temp. Range: -20°C to +85°C  
 Mating Cycles: >10,000 times

**MATERIALS AND FINISH**

Plating: Gold over Nickel

**FEATURES**

- Clip type socket (customised)
- Proven stamped contact
- Outstanding contact reliability with wiping action
- Ultra low pitch capability (0.3mm staggered)
- Minimized pad damage
- Elevator FPC stage (protect FPC and contact damage)

**PART NUMBER**

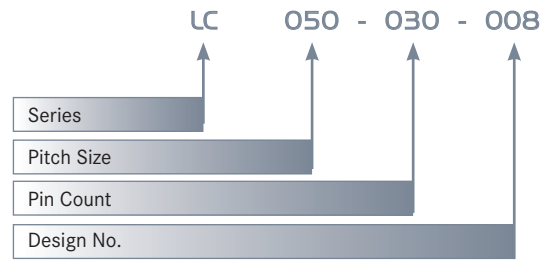

**APPLICATION**

- Testing Jig for modules with FPC / FFC

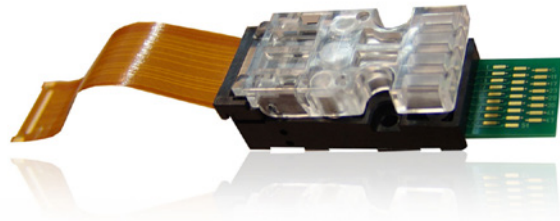

**BASE SOCKET FOR ALL OTHER CONNECTORS**

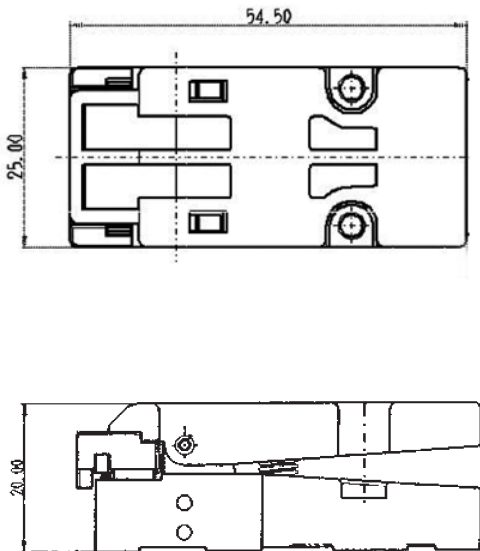

**OUTLINE SOCKET DIMENSIONS**

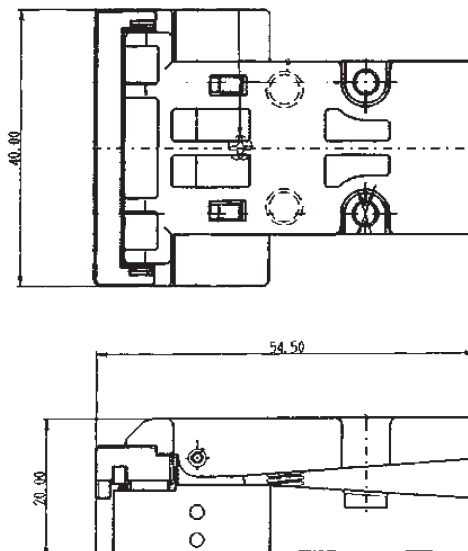



**SPECIFICATIONS**

Contact Resistance: <50mΩ  
 Contact Force: 25gf (typical)  
 Operating Temp. Range: -40°C to +125°C  
 Mating Cycles: >50,000 times

**MATERIALS AND FINISH**

Housing: PEEK / Anodized Aluminium  
 Contacts: Beryllium Copper (BeCu)  
 Plating: Gold over Nickel

**FEATURES**

- Customised socket
- Proven fine pitch probe pin
- Outstanding contact reliability
- Ultra low pitch capability (≥0.3mm staggered)
- Minimised DUT pad damage
- Integrated floating base for flex and pin protection

**PART NUMBER**

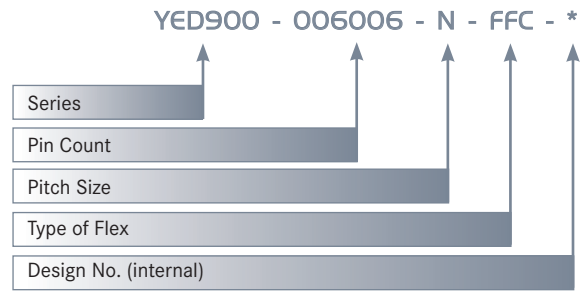

**PUSH BAR TYPE**

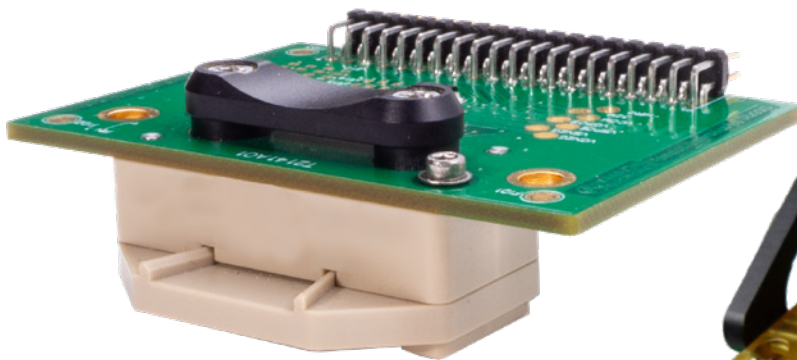

**PUSH LEVER TYPE**

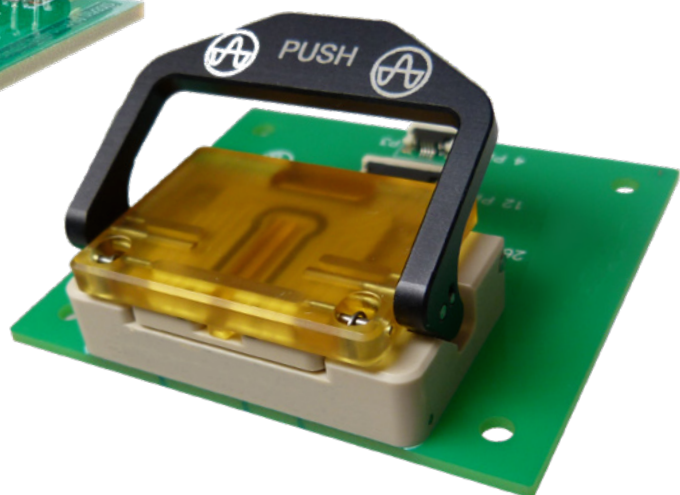

## GENERAL INFORMATION

Yamaichi Test Solution products and specialities are RoHS compliant and produced in accordance with the lead-free regulations.

The specialities are designs in close cooperation with the customer and according their requirements.

Yamaichi has more than 100 contact interfaces with multiple plunger styles for pitches between 0.30 and 2.54mm in stock.

We can vary in base, spring and plating material.

- Custom contacts are available as well as several elastomeric contact interfaces.
- Alternatively we can also provide stamped, etched or eroded contacts.

For milled mechanical and isolator piece parts we use high temperature and high resistance proofed plastic materials. Materials with a controlled reduced resistivity are available as well.

The examples on the following pages give only a small overview about the variety of our product range.

Yamaichi's Test Solution specialities combines conventional reliable contacting solution with State-of-the-Art technology.

## HIGH-REL APPLICATIONS

### FEATURES

- Integrated customised PCB designs
- Outstanding performance
- No pitch restrictions
- HF capable

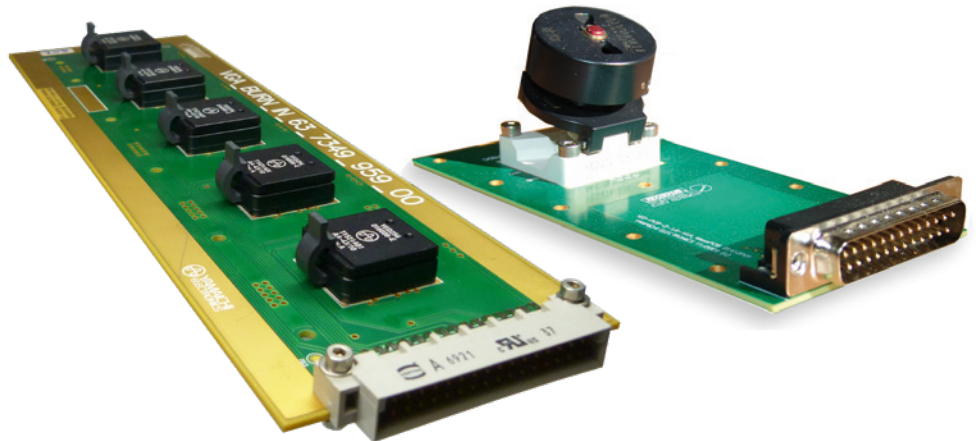

## DOCKINGS

### FEATURES

- Designed for customers own requirements
- Integrated customised PCB designs
- Outstanding performance
- HF capable

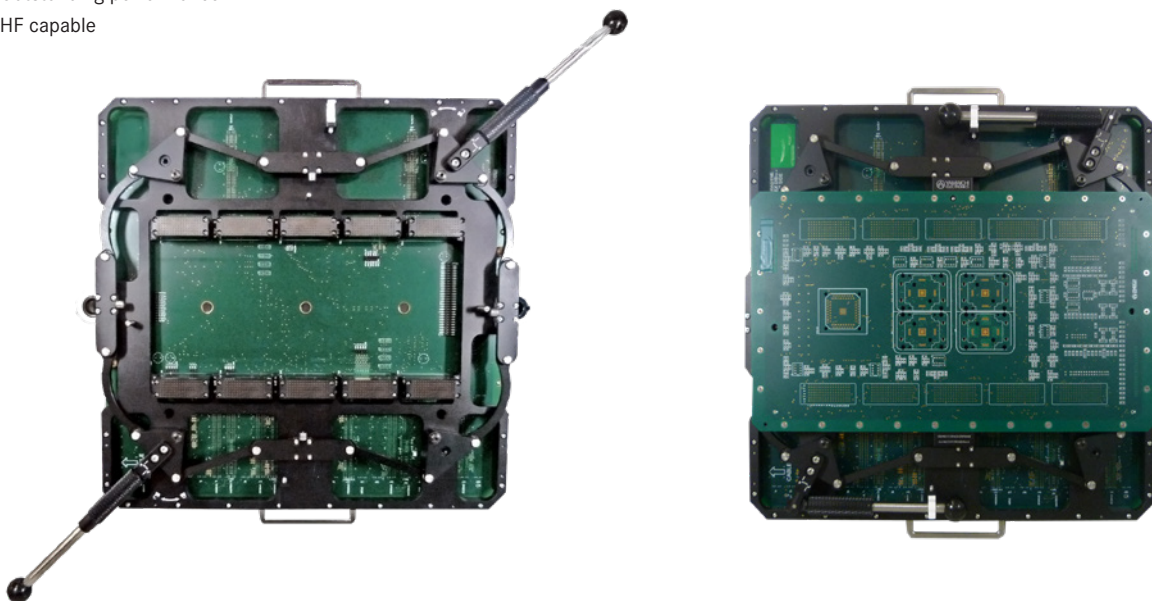

Universal Interface Board with Locking Mechanism,  
open position (no DUT)

Assembled Docking System,  
closed position (with DUT)



## IMAGING SENSOR / CAMERAS

### FEATURES

- Fully customised socket
- Optimised to reduce reflections
- Selected reliable materials
- HF capable

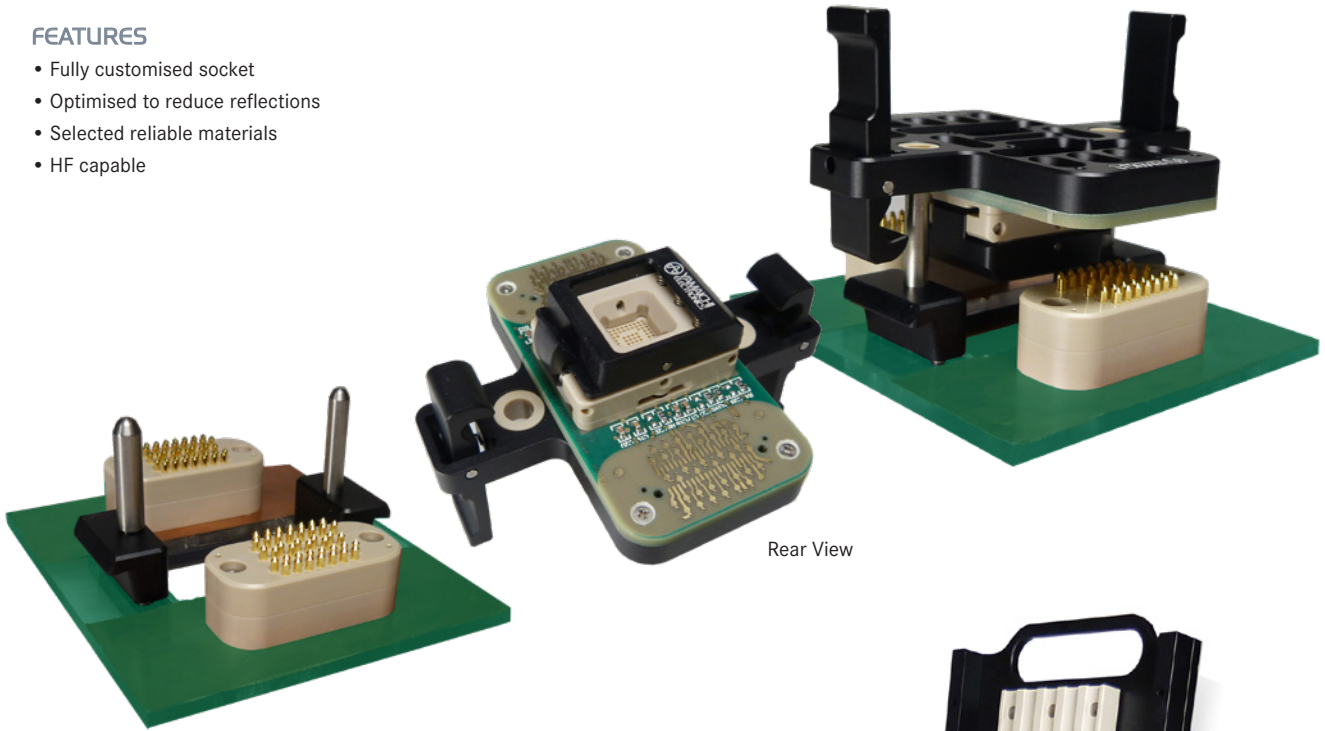

## BURN-IN LEAD FRAME SOCKETS

### FEATURES

- Able to contact lead frames at once
- High pin count capable
- Reliable probe pin technology
- Robust test socket
- Easy operating closing mechanism

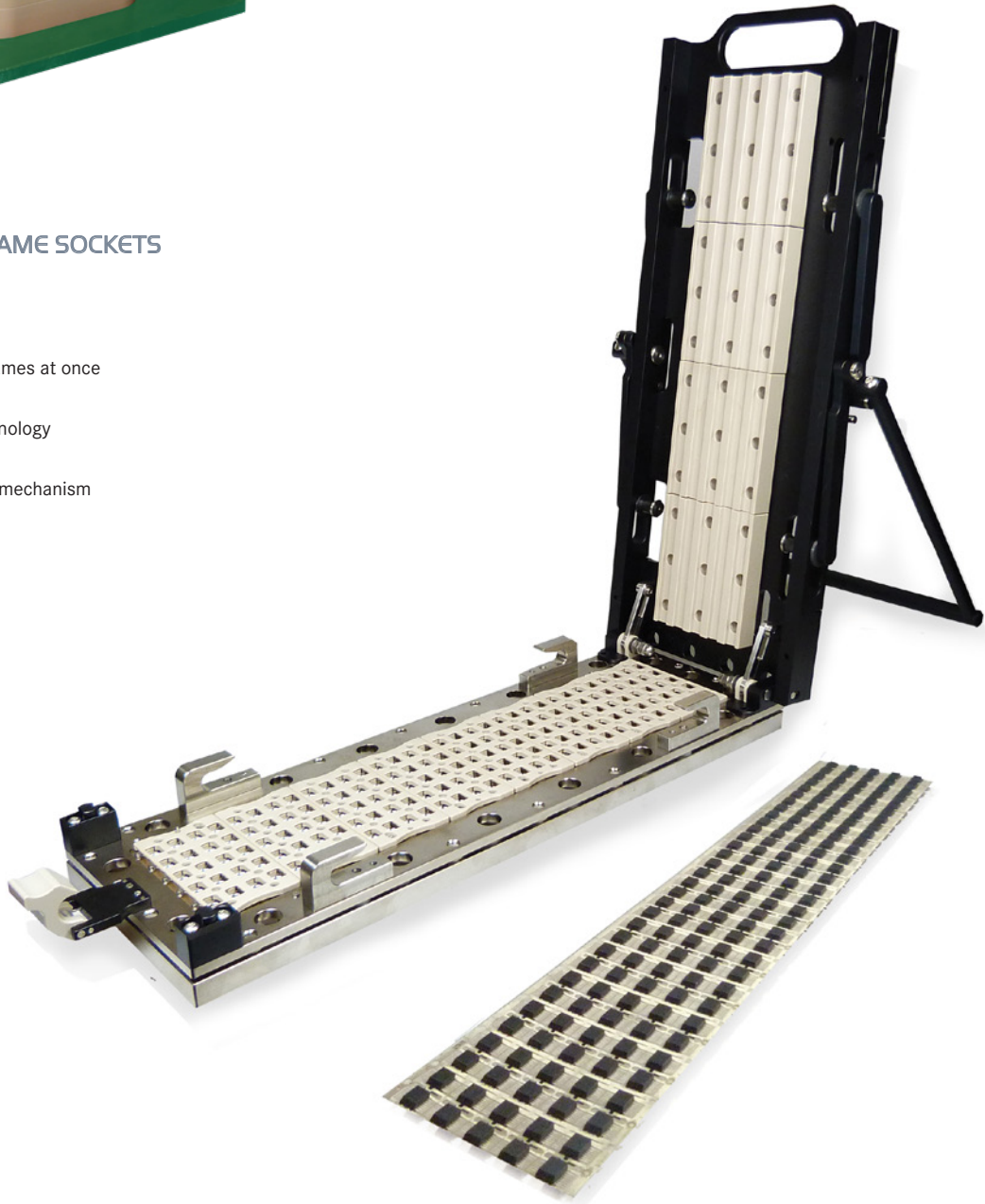

# CONTACTING SEMICONDUCTOR

An adapter board acts as a mechanical and electrical interface between the tester (ATE) and the device under test (DUT). The range of such an adaption can vary from very simple to quite complex where it has well-defined physical dimensions and it must fit perfectly into the tester environment.

A properly designed adapter board is electronically “invisible”, and does not introduce any distortion or delay to the DUT signals. The adapter board should be able to support all the tests executed on the tester and be flexible enough to support future testing.

Yamaichi Electronics adapter boards are impedance controlled and able to deal with critical signals up to the higher Giga Hertz range. Onboard measurement capabilities and a contact clearance down to 0.3mm complete this solution.

Pin Trough Hole Devices.....	76
SMT Devices.....	77

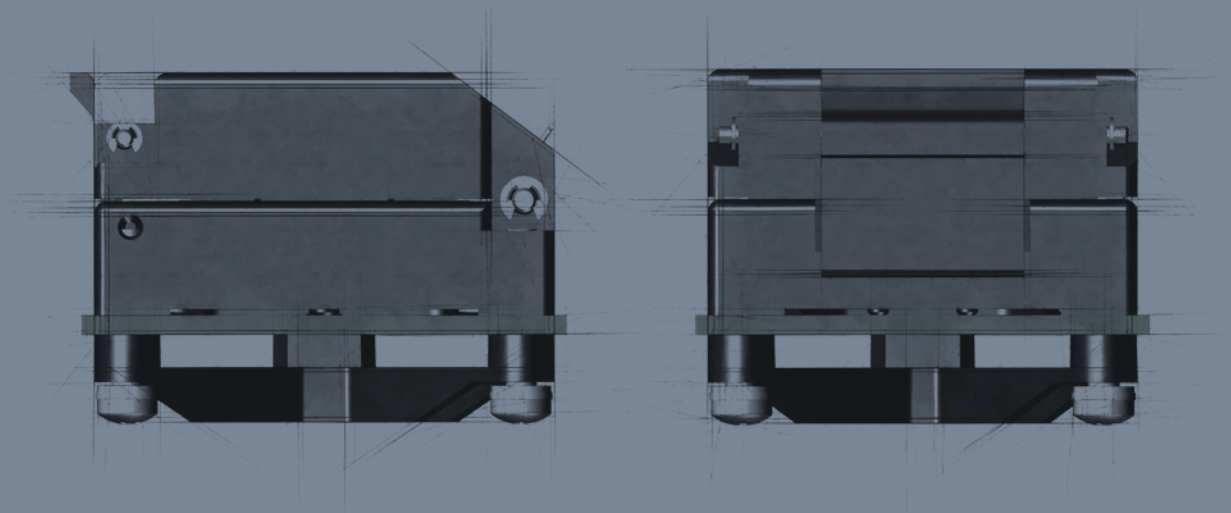

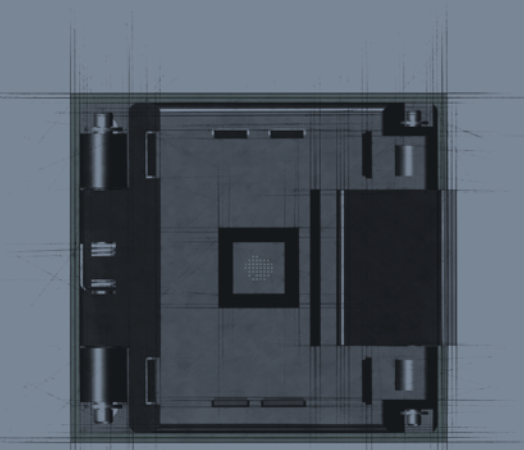
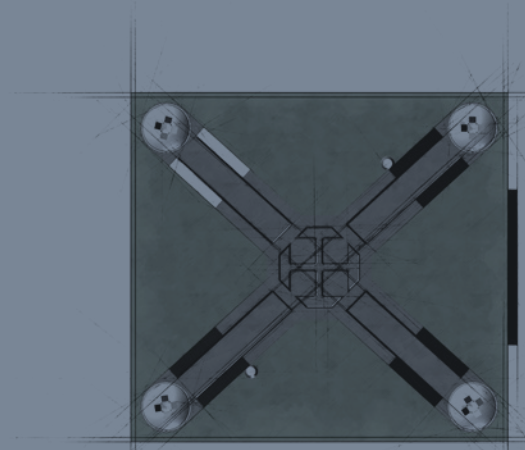
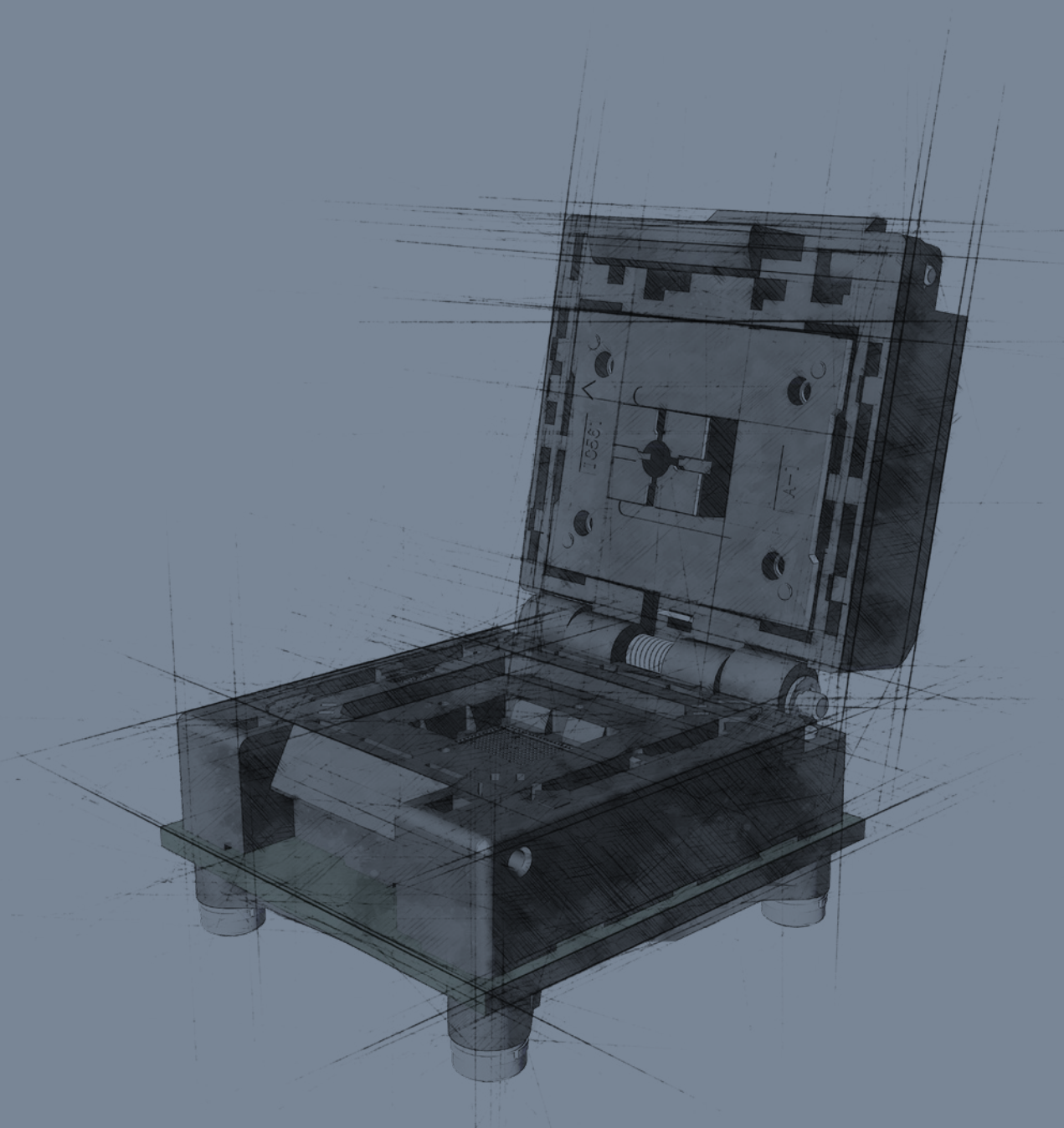

**SPECIFICATIONS**

Insulation Resistance:	1,000MΩ min. at 500V DC
Dielectric Withstanding Voltage:	700V AC for 1 minute
Contact Resistance:	30mΩ max. at 10mA/20mV max.
Current Rating:	1A max.
Operating Temperature Range:	(PSF)-40°C to +150°C (PES)-55°C to +170°C
Mating Cycles:	10,000 insertions min.

**MATERIALS AND FINISH**

Housing:	PSF, Polysulphon glass-filled PES Polyester glass-filled
Contacts:	Beryllium Copper (BeCu)
Plating:	Gold over Nickel

**FEATURES**

- 1.27 to 2.00mm pitch
- Dual wipe contacts ensure high reliability
- Low costs due to selective gold plating

**PART NUMBER**

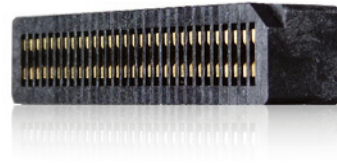
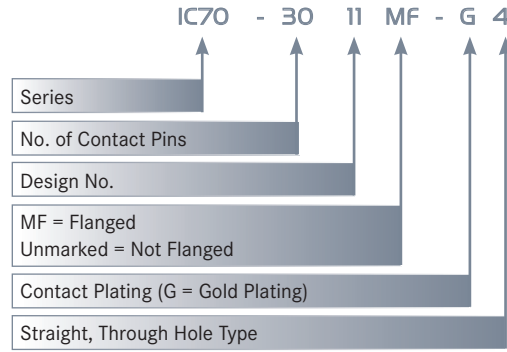

**OUTLINE SOCKET DIMENSIONS**

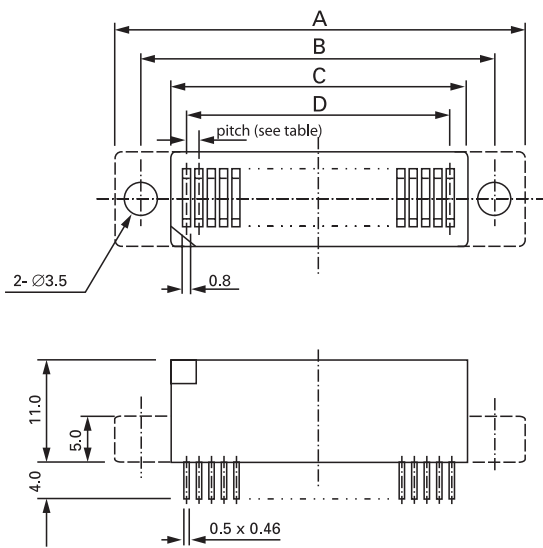

**OUTLINE SOCKET DIMENSIONS FOR IC70-5616-G4 ONLY**

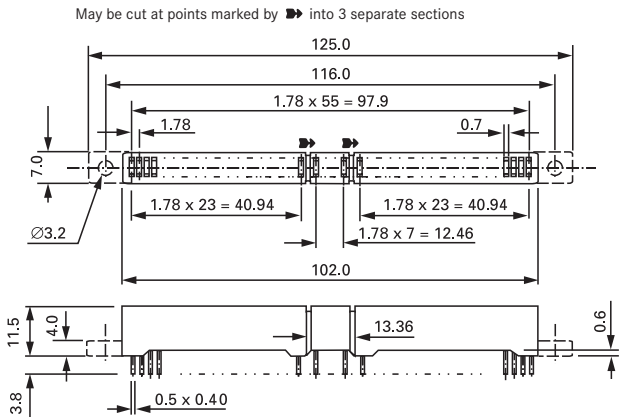

**Recommended PCB Layout**

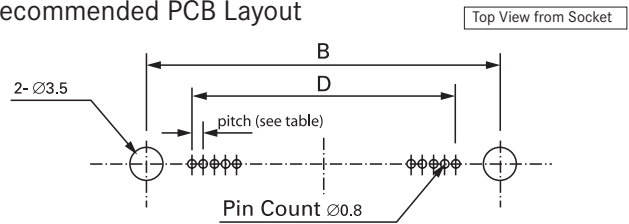

**1.27 TO 2.00MM PITCH**

Part Number	Pin Count	Pitch	A	B	C	D
IC70-0726**-G4	7	1.27	26.6	19.6	12.6	1.27 x 6 = 7.62
IC70-1217**-G4	12	2.00	41.0	34.0	27.0	2.00 x 11 = 22.00
IC70-1521**-G4	15	1.27	36.8	29.8	22.8	1.27 x 14 = 17.78
IC70-2020**-G4	20	1.50	47.5	40.5	33.5	1.50 x 19 = 28.50
IC70-2012**-G4	20	1.80	52.0	45.0	38.0	1.80 x 19 = 34.20
IC70-2313**-G4	23	1.27	44.0	38.0	32.0	1.27 x 22 = 27.94
IC70-2418**-G4	24	2.00	63.0	57.0	51.0	2.00 x 23 = 46.00
IC70-3011**-G4	30	1.80	77.0	67.0	57.0	1.80 x 29 = 52.20
IC70-3015**-G4	30	1.27	57.0	49.0	41.0	1.27 x 29 = 36.83
IC70-3019**-G4	30	1.50	62.5	55.5	48.5	1.50 x 29 = 43.50
IC70-4014**-G4	40	1.778	94.0	84.0	74.0	1.778 x 55 = 69.342
IC70-5616**-G4	56	1.78	125.0	116.0	102.0	1.78 x 55 = 97.90

Table shows only a selection of sockets available. For customised or other socket types, please contact Yamaichi Electronics

**SPECIFICATIONS**

Insulation Resistance:	1,000MΩ min. at 500V DC
Dielectric Withstanding Voltage:	700V AC for 1 minute
Contact Resistance:	30mΩ max. at 10mA/20mV max.
Current Rating:	1A max.
Operating Temperature Range:	-40°C to +170°C
Mating Cycles:	10,000 insertions min.

**MATERIALS AND FINISH**

Housing:	Polyethersulphone (PES), glass-filled
Contacts:	Beryllium Copper (BeCu)
Plating:	Gold over Nickel

**FEATURES**

- 1.27 to 1.778mm pitch
- Applicable for Zig-Zag mounted leads
- Dual wipe contacts ensure high reliability

**PART NUMBER**

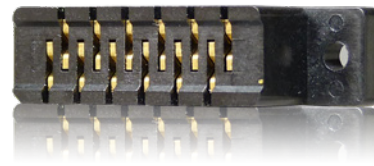
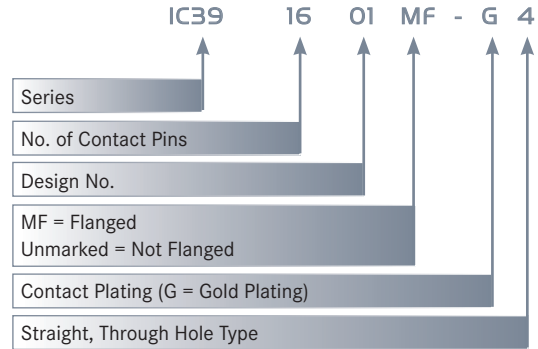

**OUTLINE SOCKET DIMENSIONS**

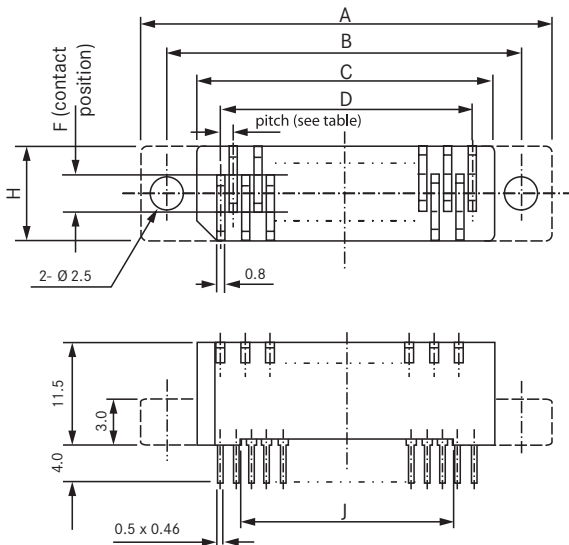

**RECOMMENDED PCB LAYOUT**

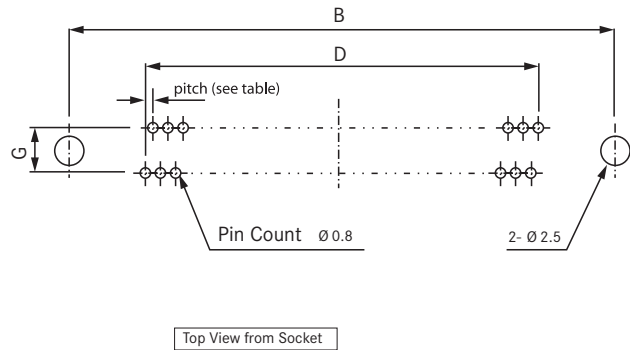

**1.27 TO 1.778MM PITCH**

Part Number	Pin Count	Pitch	A	B	C	D	F	G	H	J
IC39-1206*-G4	12	1.778	39.0	33.0	27.0	1.778 x 11 = 19.558	2.00	2.00	9.0	-
IC39-1408*-G4	14	1.70	38.0	32.0	26.0	1.70 x 13 = 22.1	5.08	5.08	11.0	-
IC39-1505*-G4	15	1.27	34.0	28.0	22.0	1.27 x 14 = 17.78	5.08	5.08	11.0	-
IC39-1511*-G4	15	1.27	34.0	28.0	22.0	1.27 x 14 = 17.78	2.54	2.54	9.0	-
IC39-1602*-G4	16	1.27	38.0	32.0	26.0	1.27 x 15 = 19.05	3.00	3.00	9.0	-
IC39-1601*-G4	16	1.50	38.0	32.0	26.0	1.50 x 15 = 22.50	3.00	3.00	9.0	-
IC39-2017*-G4	20	1.27	40.0	34.0	28.0	1.27 x 19 = 24.13	2.54	2.54	9.0	24.0
IC39-2304*-G4	23	1.27	44.0	38.0	32.0	1.27 x 22 = 27.94	2.20	2.20	9.0	-
IC39-2419*-G4	24	1.27	45.0	39.0	33.0	1.27 x 23 = 29.21	2.54	2.54	9.0	29.0
IC39-2803*-G4	28	1.27	50.0	44.0	38.0	1.27 x 27 = 34.29	2.55	2.55	9.0	-

Table shows only a selection of sockets available. For customised or other socket types, please contact Yamaichi Electronics

**SPECIFICATIONS**

Insulation Resistance: 1,000MΩ min. at 500V DC  
 Dielectric Withstanding Voltage: 700V AC for 1 minute  
 Contact Resistance: 20mΩ max. at 10mA/20mV max.  
 Current Rating: 1A max.  
 Operating Temperature Range: -40°C to +170°C (PPS)  
 Mating Cycles: 25,000 to 50,000 insertions

**MATERIALS AND FINISH**

Housing: Polyphenylenesulfide (PPS), glass filled  
 Contacts: Beryllium Copper (BeCu)  
 Plating: Gold over Nickel

**FEATURES**

- 2.54mm pitch
- Dual wipe contacts ensure high reliability
- Low costs due to selective gold plating
- Applicable for IC packages and side braze packages
- Ideal for automated burn-in

**PART NUMBER**

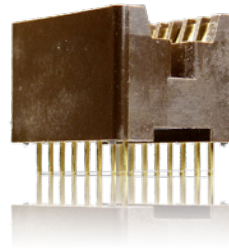
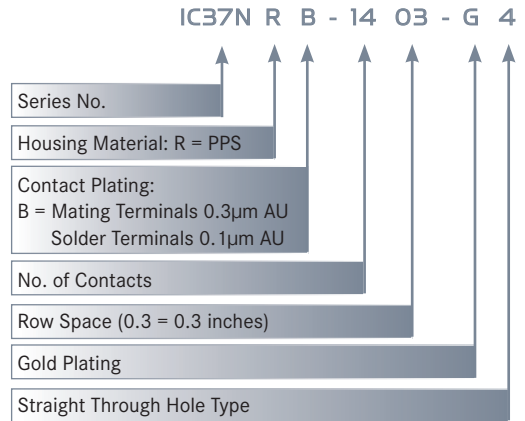

**OUTLINE SOCKET DIMENSIONS**

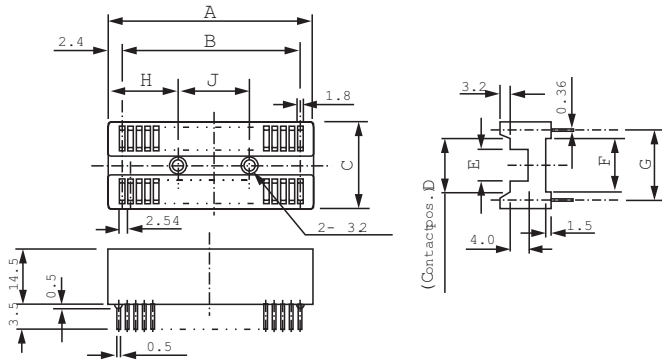

**RECOMMENDED PCB LAYOUT**

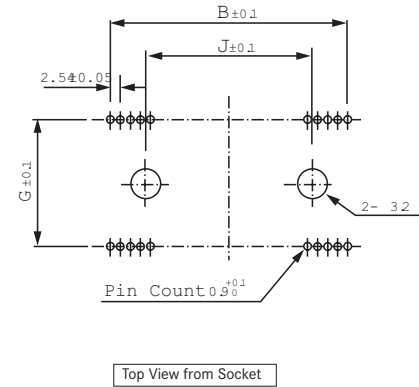

**2.54MM PITCH**

Part Number	Pin Count	A	B	C	D	E	F	G	H	J
IC37NRB-0083-G4	8	12.42	2.54 x 3 = 7.62	17.0	7.8	2.0	7.5	11.4	-	-
IC37NRB-1403-G4	14	20.04	2.54 x 6 = 15.24	17.0	7.8	2.0	7.5	11.4	-	-
IC37NRB-1603-G4	16	22.58	2.54 x 7 = 17.78	17.0	7.8	2.0	7.5	11.4	-	-
IC37NRB-1803-G4	18	25.12	2.54 x 8 = 20.32	17.0	7.8	2.0	7.5	11.4	-	-
IC37NRB-2003-G4	20	27.66	2.54 x 9 = 22.86	17.0	7.8	2.0	7.5	11.4	-	-
IC37NRB-2004-G4	20	27.66	2.54 x 9 = 22.86	19.5	10.3	2.9	8.0	13.9	-	-
IC37NRB-2203-G4	22	30.20	2.54 x 10 = 25.40	17.0	7.8	2.0	7.5	11.4	-	-
IC37NRB-2204-G4	22	30.20	2.54 x 10 = 25.40	19.5	10.3	2.9	8.0	13.9	-	-
IC37NRB-2403-G4	24	32.74	2.54 x 11 = 27.94	17.0	7.8	2.0	7.5	11.4	-	-
IC37NRB-2404-G4	24	32.74	2.54 x 11 = 27.94	19.5	10.3	2.9	8.0	13.9	-	-
IC37NRB-2406-G4	24	32.74	2.54 x 11 = 27.94	24.6	15.4	8.0	10.3	19.0	6.21	20.32
IC37NRB-2803-G4	28	37.82	2.54 x 13 = 33.02	17.0	7.8	2.0	7.5	11.4	-	-
IC37NRB-2804-G4	28	37.82	2.54 x 13 = 33.02	19.5	10.3	2.9	8.0	13.9	-	-
IC37NRB-2806-G4	28	37.82	2.54 x 13 = 33.02	24.6	15.4	8.0	10.3	19.0	6.21	25.40
IC37NRB-3203-G4	32	42.90	2.54 x 15 = 38.10	17.0	7.8	2.0	7.5	11.4	-	-
IC37NRB-3204-G4	32	42.90	2.54 x 15 = 38.10	19.5	10.3	8.0	8.0	13.9	-	-
IC37NRB-3206-G4	32	42.90	2.54 x 15 = 38.10	24.6	15.4	2.9	10.3	19.0	8.75	25.40
IC37NRB-4006-G4	40	53.06	2.54 x 19 = 48.26	24.6	15.4	8.0	10.3	13.9	15.10	25.40
IC37NRB-4206-G4	42	55.60	2.54 x 20 = 50.80	24.6	15.4	8.0	10.3	19.0	13.83	25.40
IC37NRB-44075-G4	44	58.14	2.54 x 21 = 53.54	28.4	19.2	11.8	14.1	22.8	15.10	27.94
IC37NRB-4806-G4	48	63.22	2.54 x 23 = 58.42	24.6	15.4	8.0	10.3	19.0	16.37	30.48

Table shows only a selection of sockets available. For customised or other socket types, please contact Yamaichi Electronics

**SPECIFICATIONS**

Insulation Resistance:	1,000MΩ min. at 500V DC
Dielectric Withstanding Voltage:	700V AC for 1 minute
Contact Resistance:	20mΩ max. at 10mA/20mV max.
Current Rating:	1A max.
Operating Temperature Range:	-40°C to +170°C (PES)
Mating Cycles:	25,000 to 50,000 insertions

**MATERIALS AND FINISH**

Housing:	Polyethersulphone (PES), glass-filled
Contacts:	Beryllium Copper (BeCu)
Plating:	Gold over Nickel

**FEATURES**

- Shrink pitch (1.778mm) sockets for high-density mounting
- Dual wipe contacts ensure high reliability

**PART NUMBER**

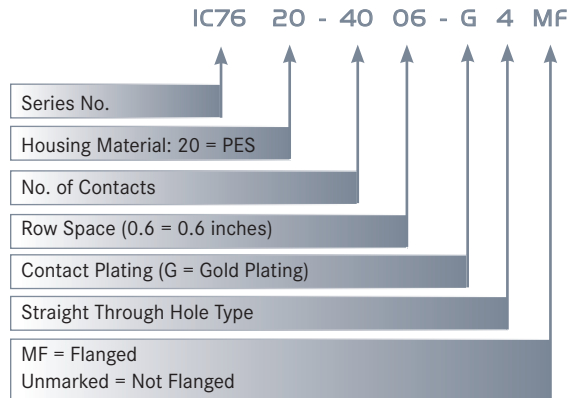

**OUTLINE SOCKET DIMENSIONS**

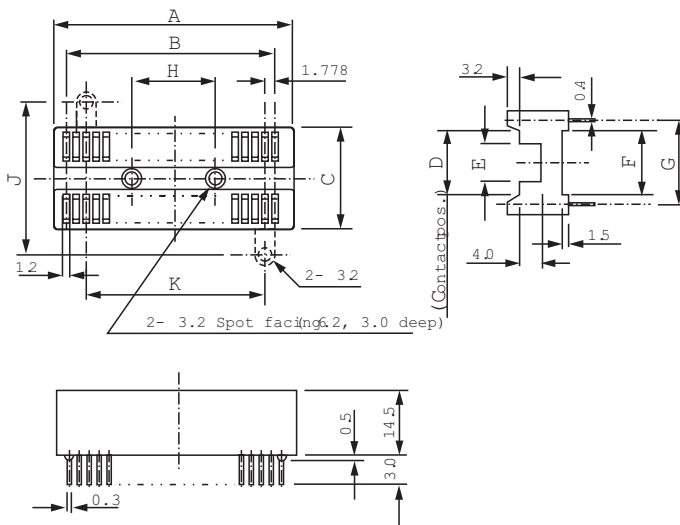

**RECOMMENDED PCB LAYOUT**

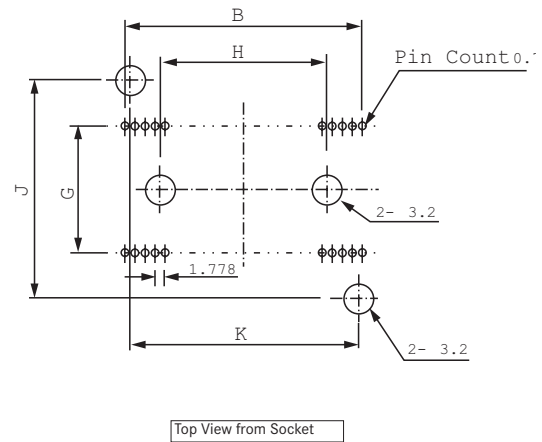

**1.778MM PITCH**

Part Number	Pin Count	A	B	C	D	E	F	G	H	J	K
IC7620-2003-G4 **	20	20.0	1.778 x 9 = 16.002	17.0	8.3	2.0	7.5	11.4	-	23.0	11.0
IC7620-2203-G4 **	22	22.0	1.778 x 10 = 17.78	17.0	8.3	2.0	7.5	11.4	-	23.0	11.0
IC7620-2403-G4 **	24	24.0	1.778 x 11 = 19.558	17.0	8.3	2.0	7.5	11.4	-	23.0	13.0
IC7620-2804-G4 **	28	27.5	1.778 x 13 = 23.114	19.5	10.8	2.9	8.0	13.9	-	25.5	16.5
IC7620-3004-G4 **	30	29.0	1.778 x 14 = 24.892	19.5	10.8	2.9	8.0	13.9	-	25.5	16.5
IC7620-4006-G4 **	40	38.0	1.778 x 19 = 33.782	24.6	15.9	8.0	10.3	19.0	25.5	30.6	25.5
IC7620-4206-G4 **	42	39.5	1.778 x 20 = 35.56	24.6	15.9	8.0	10.3	19.0	25.5	30.6	25.5
IC7620-4806-G4 **	48	45.0	1.778 x 23 = 40.894	24.6	15.9	8.0	10.3	19.0	26.0	30.6	26.0
IC7620-5206-G4 **	52	48.5	1.778 x 25 = 44.45	24.6	15.9	8.0	10.3	19.0	28.0	30.6	28.0
IC7620-64075-G4**	64	59.5	1.778 x 31 = 55.118	28.4	19.7	11.8	13.7	22.8	29.5	38.2	29.5

Table shows only a selection of sockets available. For customised or other socket types, please contact Yamaichi Electronics

**SPECIFICATIONS**

Insulation Resistance:	1,000MΩ min. at 500V DC
Dielectric Withstanding Voltage:	700V AC for 1 minute
Contact Resistance:	20mΩ max. at 10mA/20mV max.
Current Rating:	1A max.
Operating Temperature Range:	-40°C to +150°C
Mating Cycles:	10,000 insertions

**MATERIALS AND FINISH**

Housing:	Polyetherimide (PEI), glass-filled
Contacts:	Copper Alloy
Plating:	Gold over Nickel

**FEATURES**

- Shrink pitch (1.778mm) sockets for high-density mounting
- Dual wipe contacts ensure high reliability
- Two terminal lengths (3mm / 5mm) available.  
The 5mm type can be used as a piggy-back socket

**PART NUMBER**

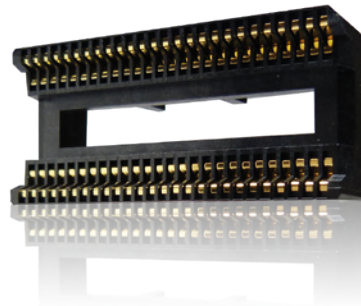
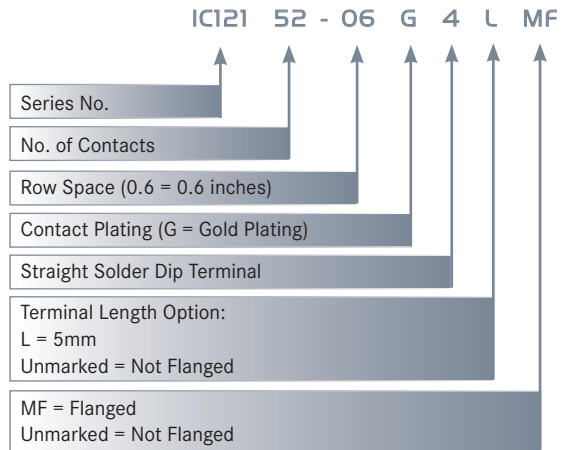

**OUTLINE SOCKET DIMENSIONS**

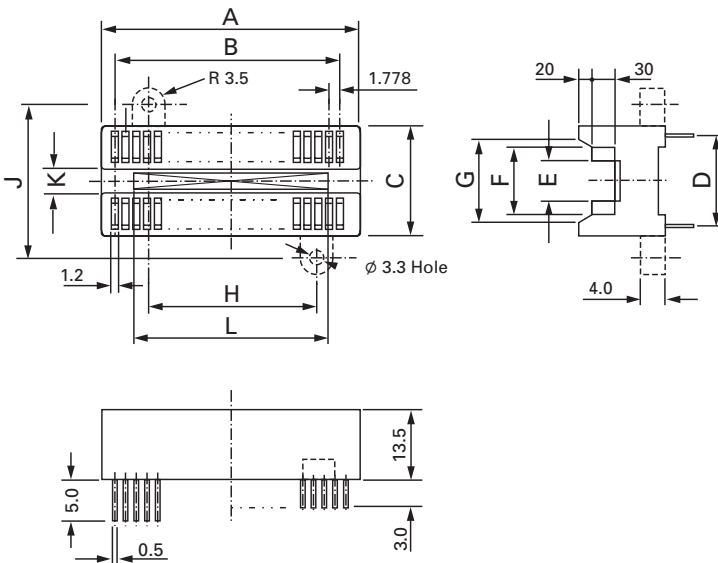

**RECOMMENDED PCB LAYOUT**

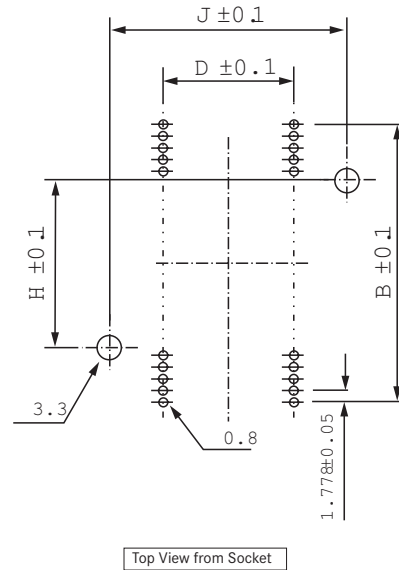

**1.778MM PITCH**

Part Number	Pin Count	A	B	C	D	E	F	G	H	J	K	L
IC121-24055-G4 **	24	24.50	19.558	22.8	14.86	7.26	14.86	16.46	12.0	29.0	-	-
IC121-2403-G4 **	24	24.00	19.558	15.0	8.30	2.00	8.30	10.10	12.0	21.0	-	-
IC121-2804-G4 **	28	27.50	23.111	17.0	10.60	3.00	10.60	12.20	16.0	23.0	-	-
IC121-4006-G4 **	40	38.20	33.782	22.8	16.54	9.27	16.54	18.14	26.0	29.0	5.5	28.2
IC121-4206-G4 **	42	40.00	35.56	22.8	16.54	9.27	16.54	18.14	20.0	29.0	5.5	30.0
IC121-4806-G4	48	45.50	40.894	22.8	16.54	9.27	16.54	18.14	26.0	29.0	5.5	35.5
IC121-5206-G4 **	52	49.00	44.45	22.8	16.54	9.27	16.54	18.14	36.0	29.0	5.5	39.0
IC121-5606-G4 **	56	52.50	48.006	22.8	16.54	9.27	16.54	18.14	36.6	29.0	5.5	42.5
IC121-64075-G4 **	64	60.00	55.188	26.4	19.80	11.40	19.80	21.40	40.0	32.4	9.4	51.3

Table shows only a selection of sockets available. For customised or other socket types, please contact Yamaichi Electronics



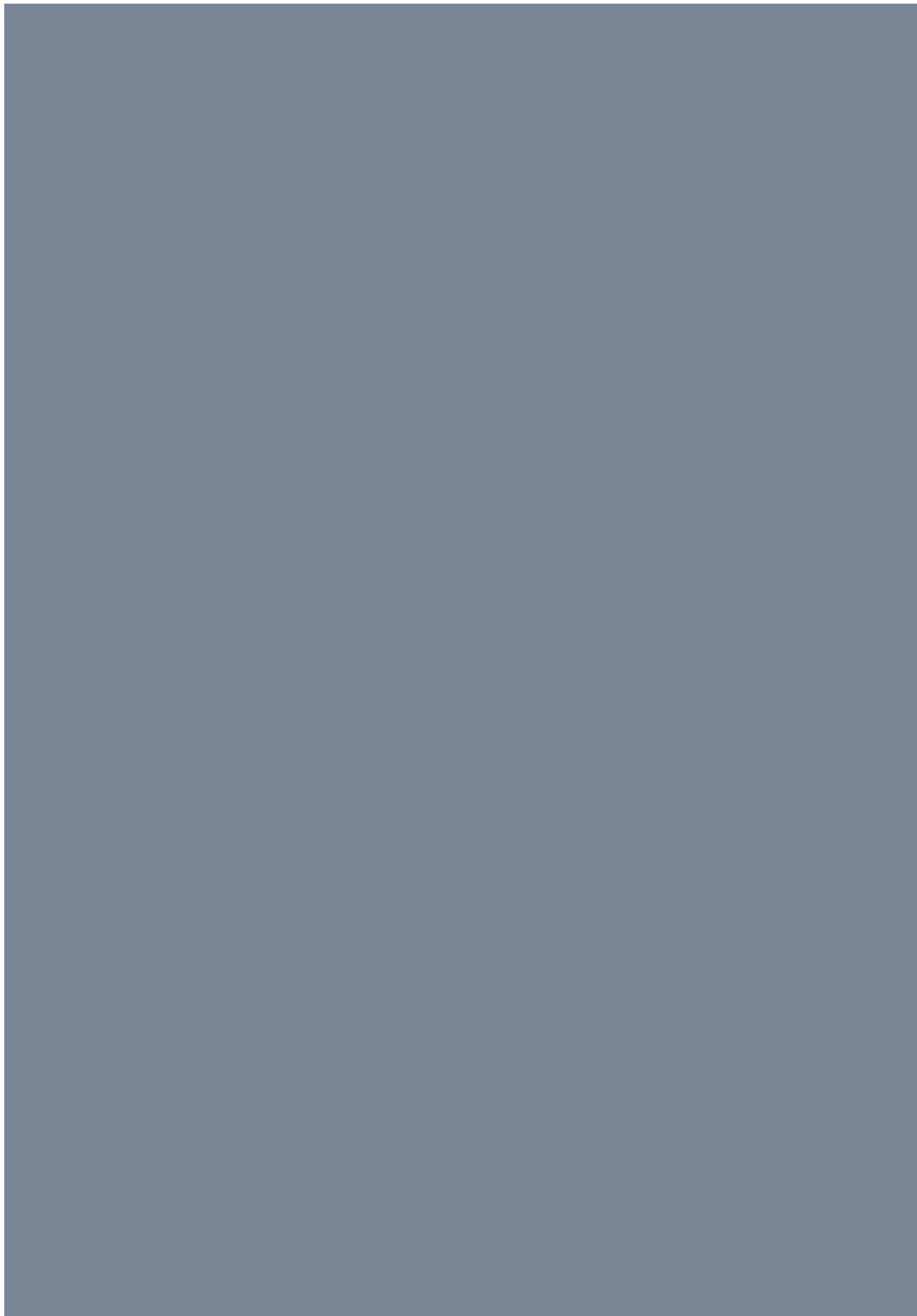

**SPECIFICATIONS**

Insulation Resistance:	1,000MΩ min. at 500V DC
Dielectric Withstanding Voltage:	700V AC for 1 minute
Contact Resistance:	30mΩ max. at 10mA/20mV max.
Current Rating:	1A max.
Operating Temperature Range:	-55°C to +170°C
Mating Cycles:	10,000 insertions min.

**MATERIALS AND FINISH**

Housing:	Polyetherimide (PEI), glass-filled
Contacts:	Beryllium Copper (BeCu)
Plating:	Gold over Nickel

**FEATURES**

- For inserting SOJ packages in "Dead-bug" orientation
- Outstanding durability with low insertion withdrawal force
- Guides for automated operation
- The larger contact area and two-point contact design ensures high contact reliability

**PART NUMBER**

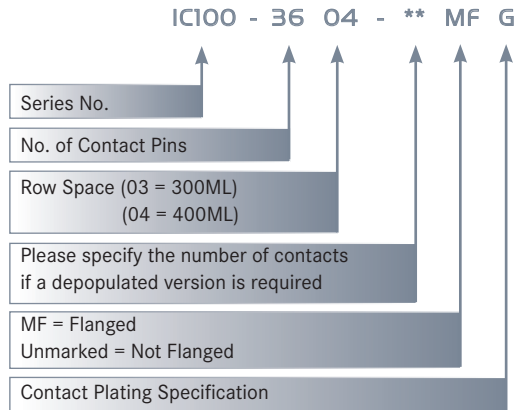

**OUTLINE SOCKET DIMENSIONS**

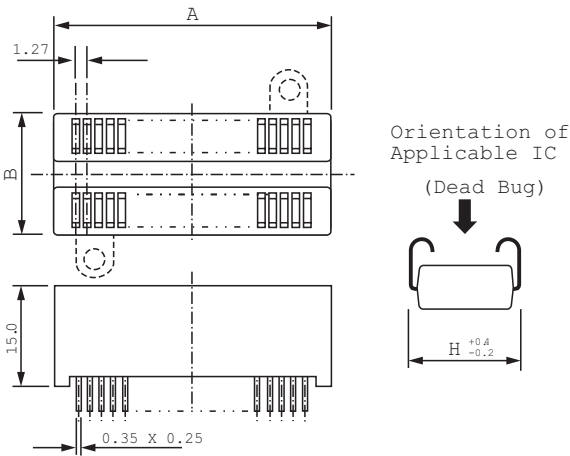

**RECOMMENDED PCB LAYOUT**

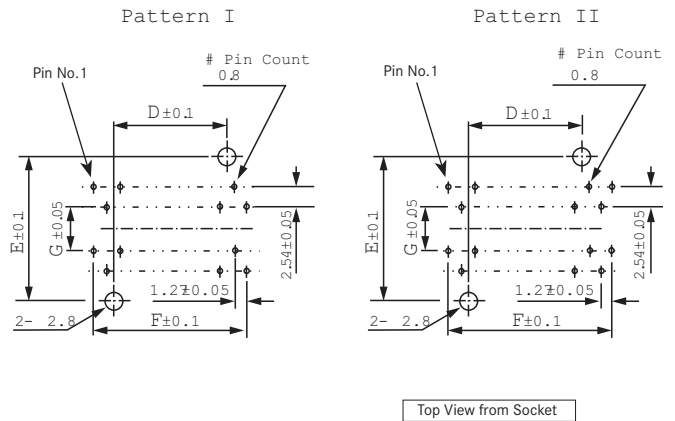

**1.27MM PITCH**

<sup>1)</sup> Flange not available

Part Number	Row Spacing	Pin Count	Socket Dim.		PCB Dimensions					IC Dim. H
			A	B	D	E	F	G	Pattern	
IC100-2003-**-xx-G	300 mil	20	16.2	15.6	9.0	21.6	1.27 x 9 = 11.43	6.86	II	7.4
IC100-2403-**-G <sup>1)</sup>	300 mil	24	18.8	15.6	11.0	21.6	1.27 x 11 = 13.97	6.86	I	7.4
IC100-2603-**-G <sup>1)</sup>	300 mil	26	20.1	15.6	13.0	21.6	1.27 x 12 = 15.24	6.86	II	7.4
IC100-2803-**-G <sup>1)</sup>	300 mil	28	21.4	15.6	14.2	21.6	1.27 x 13 = 16.51	6.86	I	7.4
IC100-3203-**-xx-G	300 mil	32	24.0	15.6	14.2	21.6	1.27 x 15 = 19.05	6.86	I	7.4
IC100-2804-**-xx-G	400 mil	28	21.4	18.0	14.2	24.1	1.27 x 13 = 16.51	9.40	I	9.9
IC100-3204-**-G <sup>1)</sup>	400 mil	32	24.0	18.0	14.2	24.1	1.27 x 15 = 19.05	9.40	I	9.9
IC100-3604-**-xx-G	400 mil	36	26.5	18.0	18.5	24.1	1.27 x 17 = 21.59	9.40	I	9.9
IC100-4004-**-xx-G	400 mil	40	29.0	18.0	20.0	24.1	1.27 x 19 = 24.13	9.40	I	9.9
IC100-4204-**-xx-G	400 mil	42	30.3	18.0	20.0	24.1	1.27 x 20 = 25.40	9.40	II	9.9
IC100-4404-**-xx-G	400 mil	44	31.6	18.0	21.6	24.1	1.27 x 21 = 26.67	9.40	I	9.9

Table shows only a selection of sockets available. For customised or other socket types, please contact Yamaichi Electronics

**SPECIFICATIONS**

Insulation Resistance:	1,000MΩ min. at 500V DC
Dielectric Withstanding Voltage:	700V AC for 1 minute
Contact Resistance:	30mΩ max. at 10mA/20mV max.
Current Rating:	1A max.
Operating Temperature Range:	-55°C to +170°C
Mating Cycles:	10,000 insertions min.

**MATERIALS AND FINISH**

Housing:	Polyetherimide (PEI), glass-filled
Contacts:	Beryllium Copper (BeCu)
Plating:	Gold over Nickel

**FEATURES**

- For inserting SOJ packages in Live-bug orientation
- Outstanding durability with low insertion withdrawal force
- Guides for automated operation
- The larger contact area and two-point contact design ensures high contact reliability

**PART NUMBER**

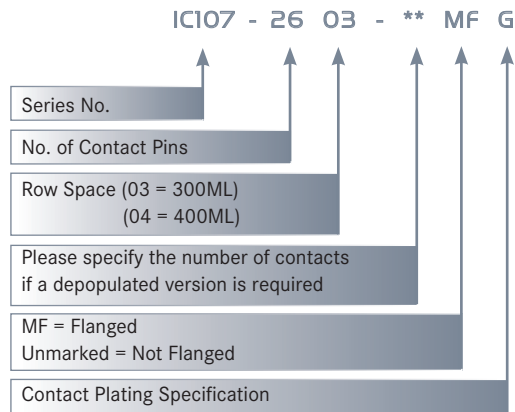

**OUTLINE SOCKET DIMENSIONS**

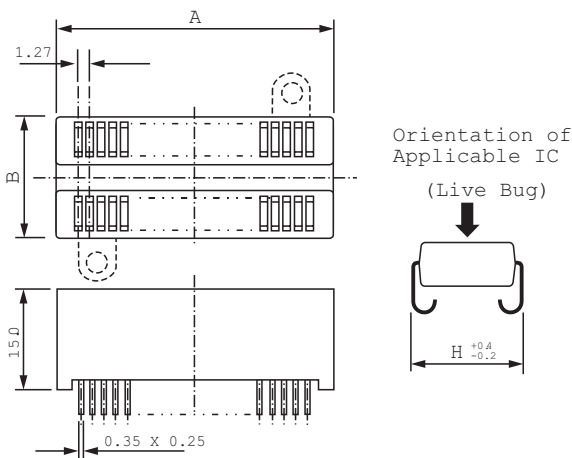

**RECOMMENDED PCB LAYOUT**

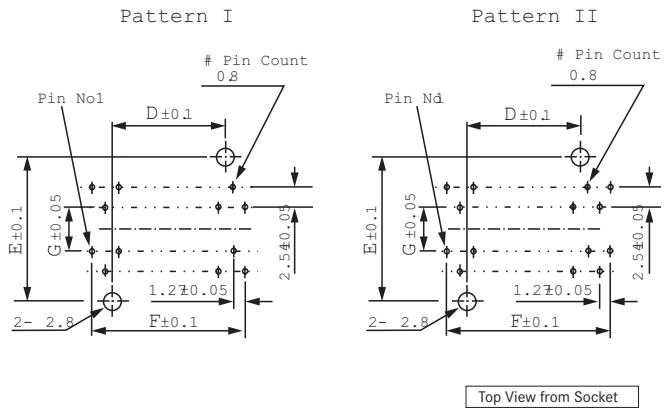

**1.27MM PITCH**

<sup>1)</sup> Flange not available

Part Number	Row Spacing	Pin Count	Socket Dim.		PCB Dimensions				IC Dim. H	
			A	B	D	E	F	G		Pattern
IC107-2403-**-xx-G	300 mil	24	18.8	15.6	11.0	21.6	1.27 x 11 = 13.97	6.86	I	8.4
IC107-2603-**-xx-G	300 mil	26	20.1	15.6	13.0	21.6	1.27 x 12 = 15.24	6.86	II	8.4
IC107-2803-**-xx-G	300 mil	28	21.4	15.6	14.2	21.6	1.27 x 13 = 16.51	6.86	I	8.4
IC107-3203-**-xx-G	300 mil	32	24.0	15.6	14.2	21.6	1.27 x 15 = 19.05	6.86	I	8.4
IC107-26035-**-G <sup>1)</sup>	350 mil	26	20.1	16.8	13.0	22.8	1.27 x 12 = 15.24	8.13	II	9.7
IC107-2804-**-xx-G	400 mil	28	21.4	18.0	14.2	24.1	1.27 x 13 = 16.51	9.40	I	10.9
IC107-3204-**-xx-G	400 mil	32	24.0	18.0	14.2	24.1	1.27 x 15 = 19.05	9.40	I	10.9
IC107-3604-**-xx-G	400 mil	36	26.5	18.0	18.5	24.1	1.27 x 17 = 21.59	9.40	I	10.9
IC107-4004-**-xx-G	400 mil	40	29.0	18.0	20.0	24.1	1.27 x 19 = 24.13	9.40	I	10.9
IC107-4204-**-xx-G	400 mil	42	30.3	18.0	20.0	24.1	1.27 x 20 = 25.40	9.40	II	10.9

Table shows only a selection of sockets available. For customised or other socket types, please contact Yamaichi Electronics

**SPECIFICATIONS**

Insulation Resistance:	1,000MΩ min. at 500V DC
Dielectric Withstanding Voltage:	700V AC for 1 minute
Contact Resistance:	30mΩ max. at 10mA/20mV max.
Current Rating:	1A max.
Operating Temperature Range:	-55°C to +170°C
Mating Cycles:	10,000 insertions min.

**MATERIALS AND FINISH**

Housing:	Polyethersulphone (PES), glass-filled
Contacts:	Beryllium Copper (BeCu)
Plating:	Gold over Nickel

**FEATURES**

- Clamshell socket for PLCC packages
- IC orientation, Live bug

**PART NUMBER**

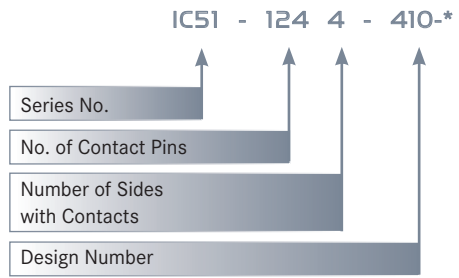

**OUTLINE SOCKET DIMENSIONS**

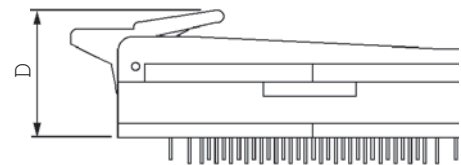
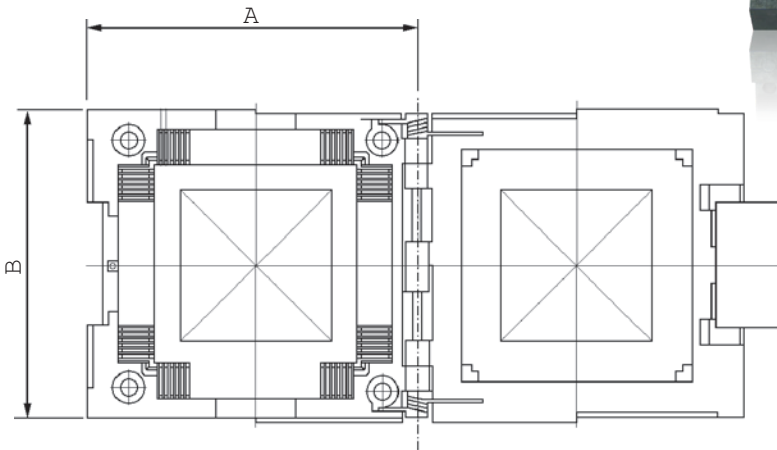

TYPICAL PLCC PACKAGE

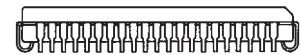
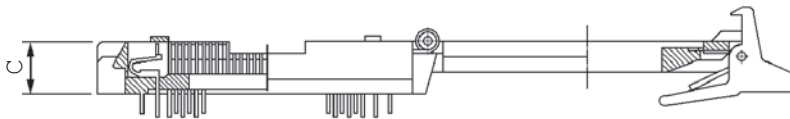

**1.27MM PITCH**

Part Number	Pin Count	A	B	C (open)	D (closed)
IC51-0204-602	20	31.5	26.0	10.0	20.0
IC51-0284-399	28	36.0	30.0	10.0	20.5
IC51-0324-453	32	35.0	30.0	9.0	19.5
IC51-0444-400	44	40.0	34.0	10.0	20.0
IC51-0524-411-*	52	43.0	38.0	10.0	23.5
IC51-0644-1329-*	64	43.0	30.0	12.0	19.0
IC51-0684-390-*	68	49.0	42.0	10.0	23.5
IC51-0844-401-1*	84	55.0	48.0	10.0	23.5
IC51-1004-405-*	100	60.6	54.0	10.0	23.5
IC51-1244-410-*	124	65.0	60.0	10.0	23.5

Table shows only a selection of sockets available. For customised or other socket types, please contact Yamaichi Electronics

**SPECIFICATIONS**

Insulation Resistance: 10,000MΩ min. at 100V DC  
 Withstanding Voltage: 500V AC for 1 minute  
 Contact Resistance: 30mΩ max. at 10mA/20mV max.  
 Operating Temp.Range: -40°C to +150°C  
 Contact Force: 11gf per pin approx.

**MATERIALS AND FINISH**

Housing: Polyetherimide (PEI), glass-filled  
 Polyethersulphone (PES), glass-filled  
 Contacts: Beryllium Copper (BeCu)  
 Plating: Gold over Nickel

**PART NUMBER**

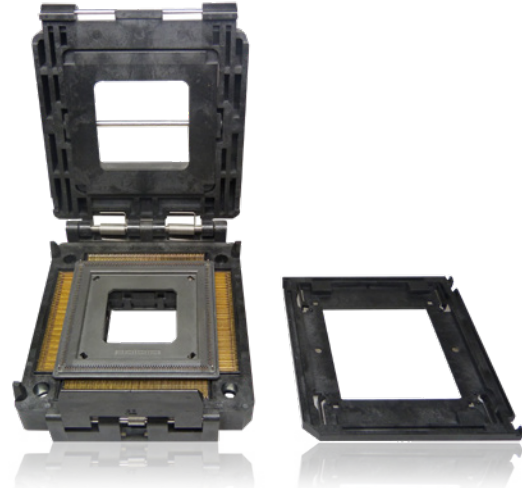
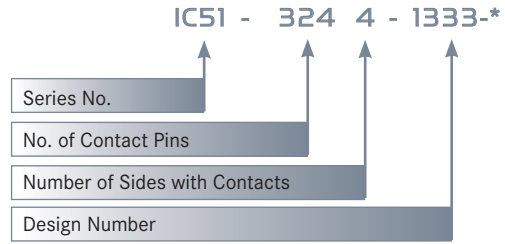

**EXAMPLE CROSS SECTION FOR A 35MM TAPE – 0.4MM PITCH – 244 PINS**

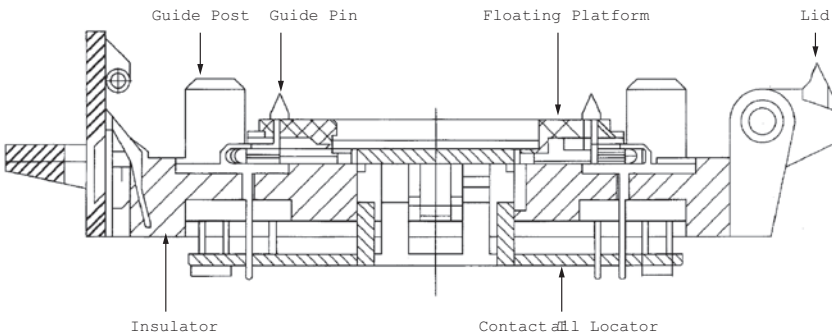

**SOCKET**

Part Number	Tape Size	Pitch
IC51-1964-1190-1	35mm	0.5 mm
IC51-2444-1191-1	35mm	0.4 mm
IC51-3244-1333-1	35mm	0.3 mm
IC51-4364-1334-1	48mm	0.3 mm
IC51-5324-1551	48mm	0.25 mm
IC51-4364-1467-1	70mm	0.5 mm
IC51-5484-1468-1	70mm	0.5 mm

**CARRIER**

Part Number	Tape Size	Window Size	Super	Width	Carrier Style
TAB-35006	35mm	24.0 mm	X		Hinge Type
TAB-35015	35mm	24.0 mm	X		Sandwich Type
TAB-48017	48mm	32.8 mm	X		Sandwich Type
TAB-48018	48mm	32.8 mm		X	Sandwich Type
TAB-70009	70mm	52.0 mm		X	1 Pc. Type
TAB-70019	70mm	52.0 mm	X		Sandwich Type
TAB-70022	70mm	52.0 mm		X	Sandwich Type

**SPECIFICATIONS**

Insulation Resistance:	1,000MΩ min. at 500V DC
Dielectric Withstanding Voltage:	700V AC for 1 minute
Contact Resistance:	30mΩ max. at 10mA/20mV max.
Current Rating:	1A max.
Operating Temperature Range:	-40°C to +170°C
Mating Cycles:	10,000 insertions min.

**MATERIALS AND FINISH**

Housing:	Upper Body:- Polyphenylenesulfide (PPS) Lower Body:- Polyetherimide (PEI), glass-filled
Contacts:	Beryllium Copper (BeCu)
Plating:	Gold over Nickel

**FEATURES**

- Two-point contacts and a larger contact width ensures high reliability
- Auto-ejecting type for automated operation (IC is inserted in „one touch“ operation and pushing the cover raises it for easy IC removal)
- Available for two types of IC orientation (Live-bug & Dead-bug)

**PART NUMBER**

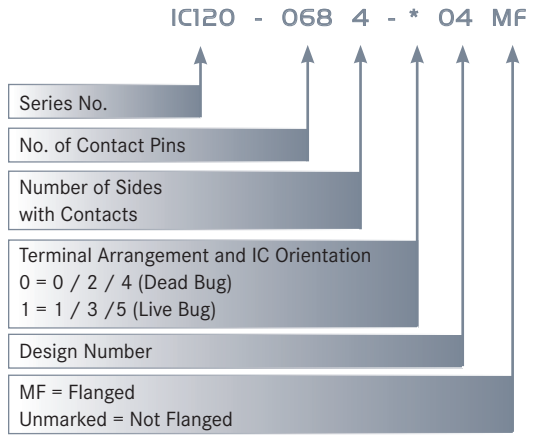

**Note:**  
Mounting Flange is not available for 18, 20 and IC120-0684-304

**OUTLINE SOCKET DIMENSIONS**

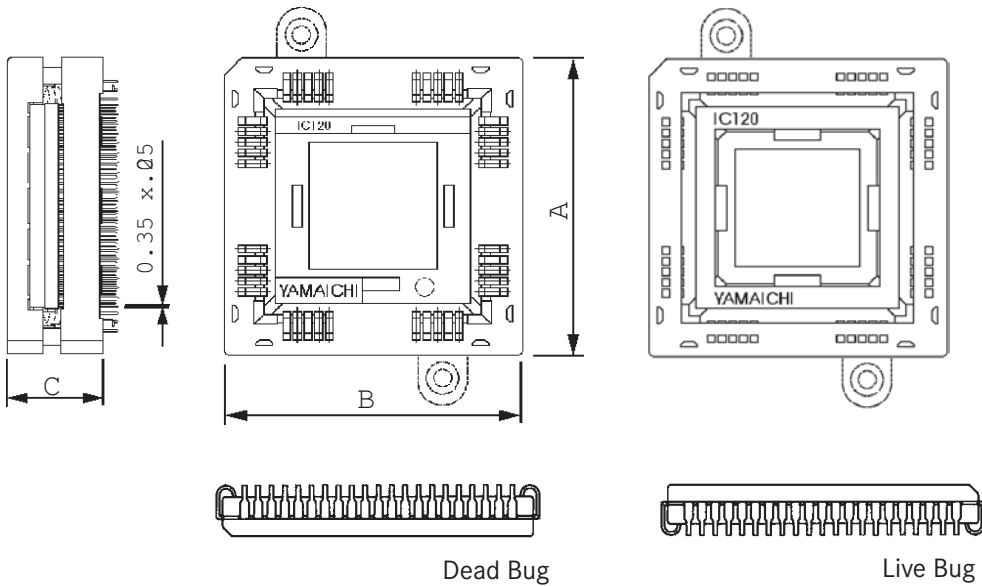

**1.27MM PITCH**

\*Inserting Direction of IC  
DB = Dead-bug    LB = Live Bug

Part Number	Pin Count	*IC Insertion	Socket Dimensions		
			A	B	C
IC120-0184-102	18	LB	17.0	21.5	19.3
IC120-0204-005	20	DB	20.0	20.0	18.0
IC120-0284-108	28	DB	23.0	23.0	18.0
IC120-0284-108	28	LB	23.0	23.0	19.3
IC120-0324-009	32	DB	22.5	25.0	18.0
IC120-0324-109	32	LB	22.5	25.0	19.3
IC120-0444-006	44	DB	28.0	28.0	18.0

Part Number	Pin Count	*IC Insertion	Socket Dimensions		
			A	B	C
IC120-0444-106	44	LB	28.0	28.0	19.3
IC120-0524-007	52	DB	30.0	30.0	18.0
IC120-0524-107	52	LB	30.0	30.0	19.3
IC120-0684-004	68	DB	35.0	35.0	18.0
IC120-0684-104	68	LB	35.0	35.0	19.3
IC120-0844-003	84	LB	40.0	40.0	18.0
IC120-0844-103	84	LB	40.0	40.0	19.3

Table shows only a selection of sockets available. For customised or other socket types, please contact Yamaichi Electronics

**SERIES IC51 (CLAMSHELL - TH) - 0.40 TO 1.27MM PITCH**  
SOP, TSOP TYPE I & II

**SPECIFICATIONS**

Insulation Resistance:	1,000MΩ min. at 500V DC
Dielectric Withstanding Voltage:	700V AC for 1 minute
Contact Resistance:	30mΩ max. at 10mA/20mV max.
Operating Temperature Range:	-40°C to +150°C (for type PSF) -55°C to +170°C (for type PES & PEI)
Mating Cycles:	10,000 insertions min.

**MATERIALS AND FINISH**

Housing:	Polyetherimide (PEI), glass-filled
Contacts:	Beryllium Copper (BeCu)
Plating:	Gold over Nickel

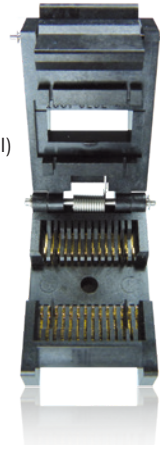

**PART NUMBER**

IC51 - 028 2 - 334-1 - MF

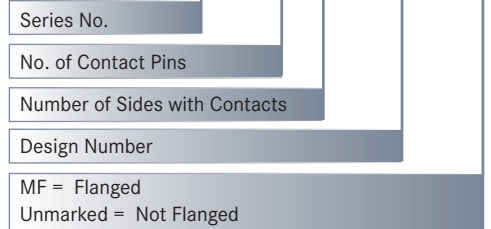

**SERIES IC189 (OPEN TOP - TH) - 0.40 TO 1.27MM PITCH**  
SOP, TSOP TYPE I & II

**SPECIFICATIONS**

Insulation Resistance:	1,000MΩ min. at 100V DC, pitch 0.4, 0.5 1,000MΩ min. at 500V DC, pitch 0.65, 0.8, 1.27
Dielectric Withstanding Voltage:	100V AC for 1 minute, pitch 0.4, 0.5 500V AC for 1 minute, pitch 0.65 700V AC for 1 minute, pitch 0.8, 1.27
Contact Resistance:	30mΩ max. at 10mA/20mV max.
Operating Temperature Range:	-40°C to +150°C
Mating Cycles:	10,000 insertions
Contact Force:	20g to 80g per pin

**MATERIALS AND FINISH**

Housing:	Polysulphone (PSF), glass-filled Polyethersulphone (PES), glass-filled Polyetherimide (PEI), glass-filled
Contacts:	Beryllium Copper (BeCu)
Plating:	Gold over Nickel

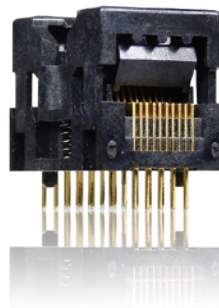

**PART NUMBER**

IC189 - 016 2 - 019 - \* \*

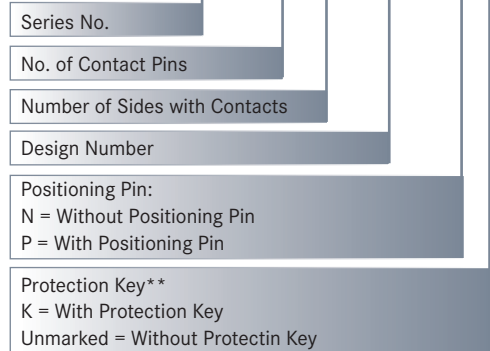

\*\* Protection Key: Prevents IC from releasing during transportation

**SERIES IC235 (OPEN TOP - TH) - 1.27MM PITCH**  
SOP, TSOP TYPE II

**SPECIFICATIONS**

Insulation Resistance:	1,000MΩ min. at 500V DC
Dielectric Withstanding Voltage:	700V AC for 1 minute
Contact Resistance:	30mΩ max. at 10mA/20mV max.
Operating Temperature Range:	-40°C to +150°C
Mating Cycles:	10,000 insertions min.
Contact Force:	20g to 80g per pin

**MATERIALS AND FINISH**

Housing:	Polyetherimide (PEI), glass-filled
Contacts:	Beryllium Copper (BeCu)
Plating:	Gold over Nickel

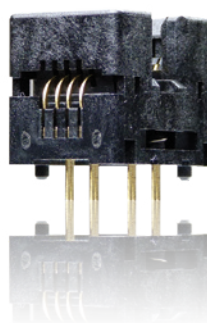

**PART NUMBER**

IC235 - 020 2 - 201 - \*

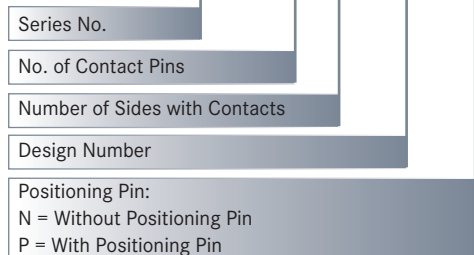

**SERIES IC191 (OPEN TOP - TH) - 0.50MM PITCH  
THIN SMALL OUTLINE PACKAGE (TSOP TYPE I)**

**SPECIFICATIONS**

Insulation Resistance:	1,000MΩ min. at 500V DC
Dielectric Withstanding Voltage:	700V AC for 1 minute
Contact Resistance:	30mΩ max. at 10mA/20mV max.
Current Rating:	1A max.
Operating Temperature Range:	-40°C to +170°C
	-40°C to +150°C (type -004*)
Mating Cycles:	10,000 insertions min.
Contact Force:	20g to 80g per pin

**MATERIALS AND FINISH**

Housing:	Polyetherimide (PEI), glass-filled
Contacts:	Beryllium Copper (BeCu)
Plating:	Gold over Nickel

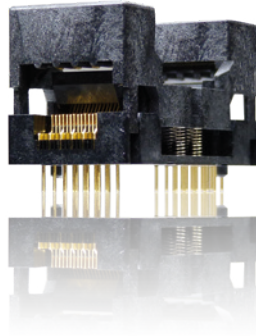

**PART NUMBER**

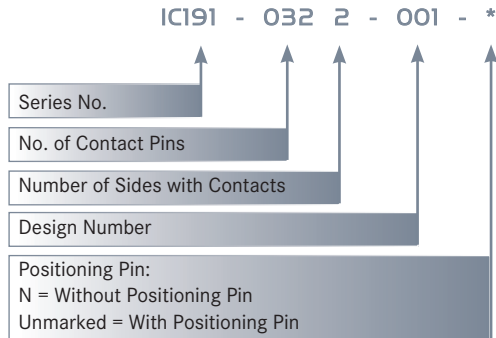

**CONTACT STYLES**

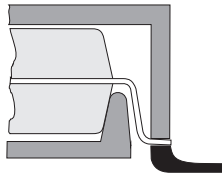

SERIES IC51

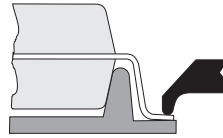

SERIES IC189 / IC191

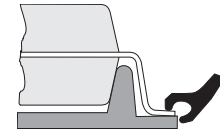

SERIES IC235

**SPECIALITIES**

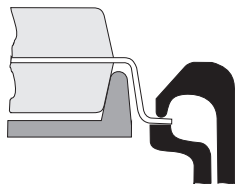

SERIES IC (KELVIN)

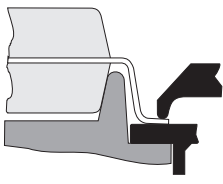

SERIES IC (TWO POINT CONTACT)

\*SOP variations e.g. TSSOP...

cont'd next page



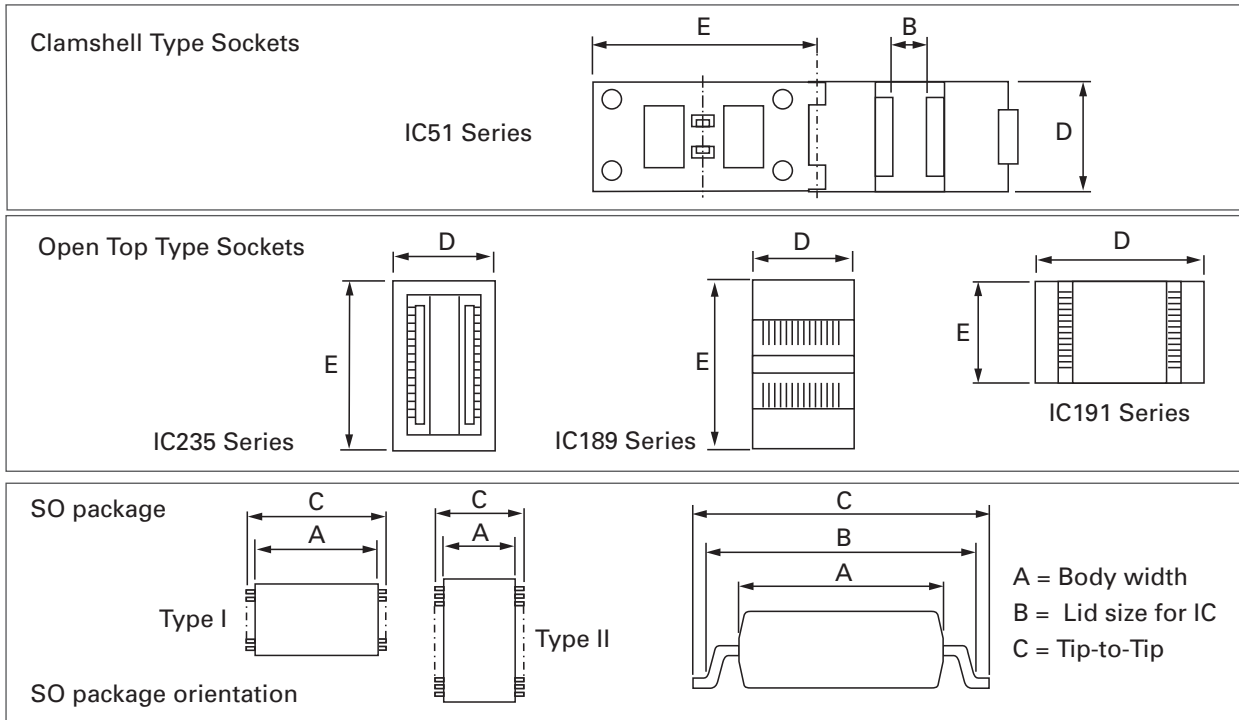

C L = Clamshell, OT = Open Top, S = Separator, FB = Floating Base

### 0.40MM PITCH

Part Number	Pin Count	IC Body A	IC Socket and Lid Size B (max.)	IC Tip-to-Tip C	Socket Dimensions D x E	Package Type	Note
IC51-0142-2074	14	4.40	5.70	6.40	16.0 x 34.0	SOP	CL/FB
IC51-0202-2072	20	4.40	5.70	6.40	16.0 x 34.0	SOP	CL/FB
IC51-0242-2071	24	4.40	5.70	6.40	16.0 x 34.0	SOP	CL/FB
IC189-0482-111*-2	48	-	12.40	4.00	34.0 x 16.0	TSOP I	OT
IC51-0482-2069	48	4.40	5.70	6.40	20.0 x 34.0	SOP	CL/FB
IC189-0522-124*-*	52	-	8.69	10.49	30.5 x 18.0	TSOP I	OT
IC51-0562-2067	56	4.40	5.70	6.40	20.0 x 34.0	SOP	CL/FB
IC51-0802-2077	80	6.10	7.45	8.10	34.0 x 34.0	SOP	CL/FB

### 0.50MM PITCH

Part Number	Pin Count	IC Body A	IC Socket and Lid Size B (max.)	IC Tip-to-Tip C	Socket Dimensions D x E	Package Type	Note
IC51-0242-1006*-*	24	14.30	15.20	16.00	15.0 x 40.0	TSOP I	CL/FB
IC51-0302-2037**-*	30	4.40	5.70	6.40	18.0 x 38.0	SOP	CL/FB
IC191-0322-001*-*	32	18.40	-	20.00	40.0 x 16.0	TSOP I	OT
IC51-0322-1031*-*	32	12.00	13.30	14.00	16.0 x 33.5	TSOP I	CL/FB
IC51-0322-1207*-*	32	18.40	19.30	20.00	18.0 x 44.0	TSOP I	CL/FB
IC51-0322-883*-*	32	14.00	14.50	16.00	16.0 x 39.0	TSOP I	CL/FB
IC51-0382-2036*-*	38	4.40	5.70	6.40	25.0 x 38.0	SOP	CL/FB
IC189-0402-068*-*	40	18.40	-	20.00	40.0 x 16.0	TSOP I	OT
IC191-0402-002*-*	40	18.40	-	20.00	18.0 x 40.0	TSOP I	OT
IC51-0402-1174*-*	40	18.40	19.30	20.00	18.0 x 44.0	TSOP I	CL/FB
IC51-0402-1557**-*	40	12.00	13.40	14.00	20.0 x 44.0	TSOP I	CL/FB
IC189-0482-066*-*	48	16.40	-	18.00	36.0 x 20.0	TSOP I	OT
IC189-0482-077*-*	48	18.40	-	20.00	40.0 x 18.0	TSOP I	OT
IC189-0482-094*-*	48	6.10	-	8.10	28.1 x 18.2	SOP	OT
IC191-0482-004*-*	48	18.40	-	20.00	40.0 x 20.0	TSOP I	OT
IC51-0482-1099*-*	48	16.40	17.60	18.00	20.0 x 44.0	TSOP I	CL/FB
IC51-0482-1513*-*	48	6.10	7.20	8.10	22.0 x 38.0	SOP	CL/FB
IC51-0482-2018	48	18.40	19.15	20.00	20.0 x 44.0	TSOP I	CL/FB
IC53-0502-912	50	4.40	-	6.40	24.3 x 34.0	SOP	NO LID
IC189-0562-067*-*	56	18.40	-	20.00	40.0 x 20.0	TSOP I	OT
IC191-0562-003*-*	56	18.40	-	20.00	21.5 x 40.0	TSOP I	OT
IC51-0562-1514**-*	56	6.10	7.20	8.10	29.0 x 38.0	SOP	CL/FB
IC53-0642-911	64	6.10	-	8.10	30.0 x 34.0	SOP	NO LID

**0.55 / 0.6 / 0.635MM PITCH**

Part Number	Pin Count	IC Body A	IC Socket and Lid Size B (max.)	IC Tip-to-Tip C	Socket Dimensions D x E	Package Type	Note
IC51-0282-673-1	28	11.80	12.60	13.40	15.0 x 37.0	SOP	CL/FB
IC51-0322-910	32	14.00	14.60	15.20	17.5 x 39.0	SOP	CL/FB
IC51-0562-1387-**	56	7.60	9.40	10.30	21.0 x 35.0	SOP	CL/S

**0.65MM PITCH**

Part Number	Pin Count	IC Body A	IC Socket and Lid Size B (max.)	IC Tip-to-Tip C	Socket Dimensions D x E	Package Type	Note
IC51-0162-778-**	16	4.40	5.60	6.40	16.0 x 32.0	SOP	CL/S
IC51-0162-911	16	4.40	5.60	6.40	16.0 x 32.0	SOP	CL/FB
IC189-0202-038*	20	6.10	-	8.10	24.0 x 22.5	SOP	OT
IC51-0202-779-**	20	4.40	5.60	6.40	16.0 x 32.0	SOP	CL/S
IC51-0202-912-**	20	4.40	5.60	6.40	16.0 x 32.0	SOP	CL/FB
IC51-0242-1341-**	24	4.40	5.60	6.40	16.0 x 32.0	SOP	CL/S
IC189-0242-081P	24	6.10	-	7.70	13.6 x 21.5	SOP	OT
IC51-0242-761	24	5.60	6.70	7.60	16.0 x 32.0	SOP	CL/S
IC51-0242-913-**	24	5.60	6.70	7.60	16.0 x 32.0	SOP	CL/FB
IC51-755 KS-13330	28	5.60	6.70	7.60	16.0 x 32.0	SOP	CL/S
IC51-0302-755-**	30	5.60	6.70	7.60	16.0 x 32.0	SOP	CL/S
IC189-0302-121	30	6.10	-	8.10	22.0 x 24.0	SOP	OT
IC51-0302-914-**	30	5.60	6.70	7.60	16.0 x 32.0	SOP	CL/FB
IC51-0402-1347	40	5.50	6.70	7.80	16.0 x 32.0	SOP	CL/S
IC51-0402-1396	40	6.30	7.20	8.20	16.0 x 32.0	SOP	CL/S
IC189-0482-047N	48	8.00	-	10.00	24.0 x 22.5	SOP	OT
IC51-0482-1163	48	7.60	9.60	10.16	21.0 x 36.0	SOP	CL/S

**0.80MM PITCH**

Part Number	Pin Count	IC Body A	IC Socket and Lid Size B (max.)	IC Tip-to-Tip C	Socket Dimensions D x E	Package Type	Note
IC51-0122-1836-1-*	12	4.40	5.90	6.40	14.0 x 32.4	SOP	CL/S
IC51-0242-308	24	5.40	6.20	7.20	32.0 x 38.5	SOP	CL/FB
IC51-0242-577	24	7.80	9.30	10.00	22.0 x 32.5	SOP	CL/S
IC51-0362-309	36	8.40	11.00	12.10	32.0 x 38.5	SOP	FB
IC189-0422-025	42	8.40	-	11.93	25.0 x 25.4	SOP	OT
IC51-0422-393	42	8.40	11.00	12.10	32.0 x 38.0	SOP	FB
IC51-0482-1009	48	13.70	15.10	16.00	28.0 x 42.5	SOP	FB
IC51-0502-1708*	50	10.16	11.00	11.80	26.0 x 36.5	SOP	CL/S
IC189-0542-088-**	54	10.16	-	11.76	24.9 x 29.8	SOP	OT
IC189-0542-093N	54	10.16	-	11.76	24.9 x 29.8	SOP	OT
IC51-0562-2144	56	13.30	15.15	16.00	22.0 x 48.5	SOP	CL/S
IC189-0622-084P	62	16.00	-	18.00	31.46 x 34.60	SOP	OT
IC189-0642-007	64	12.00	-	14.25	27.35 x 34.10	SOP	OT
IC189-0642-069*-**	64	10.70	-	14.10	27.05 x 33.80	SOP	OT
IC189-0702-074P	70	12.64	-	15.90	29.3 x 37.0	SOP	OT
IC51-0702-1965	70	12.80	14.90	15.90	36.0 x 42.0	SOP	CL/S
IC51-0442-1709-**	44 (50)	10.20	11.00	11.80	26.0 x 36.5	SOP	CL/S

Table shows only a selection of sockets available. For customised or other socket types, please contact Yamaichi Electronics

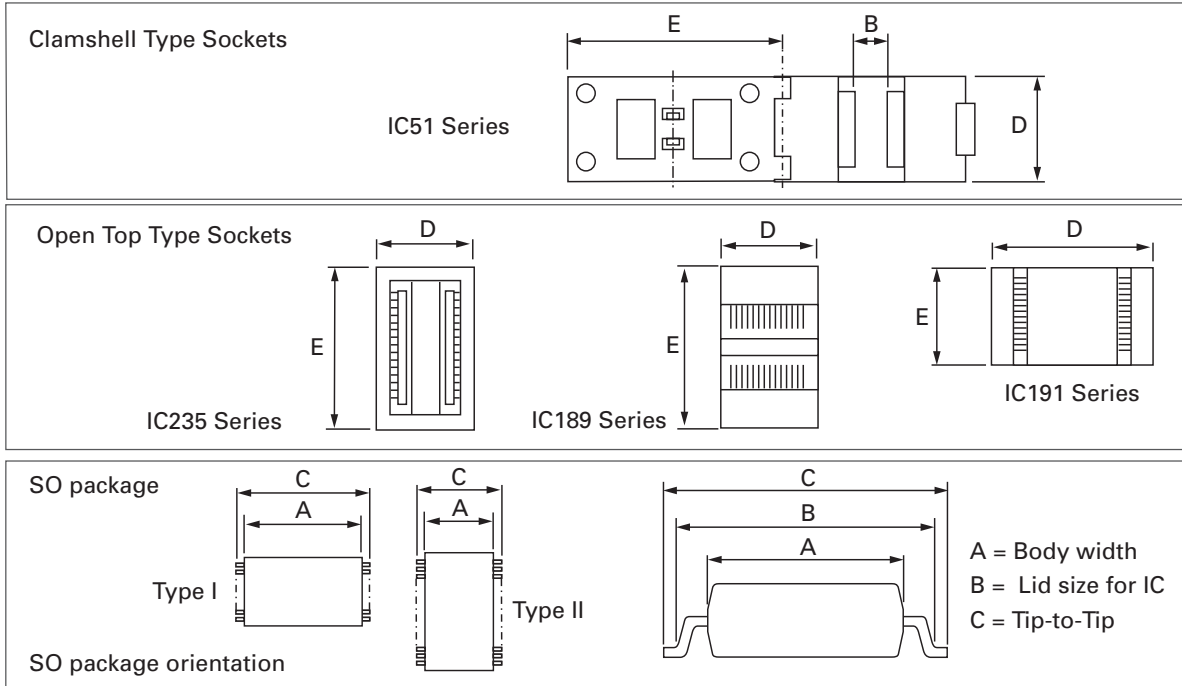
**1.00MM PITCH**

C L = Clamshell, OT = Open Top, S = Separator, FB = Floating Base

Part Number	Pin Count	IC Body A	IC Socket and Lid Size B (max.)	IC Tip-to-Tip C	Socket Dimensions D x E	Package Type	Note
IC51-0242-310-**	24	4.5	5.2	6.0	18.0 x 28.5	SOP	CL/S
IC51-0322-948	32	8.2	10.5	11.8	20.0 x 32.0	SOP	CL/S
IC51-0342-741	34	7.8	7.9	9.4	22.0 x 35.0	SOP	CL/S

**1.25MM PITCH**

Part Number	Pin Count	IC Body A	IC Socket and Lid Size B (max.)	IC Tip-to-Tip C	Socket Dimensions D x E	Package Type	Note
IC51-0142-951	14	4.4	5.2	5.9	24.0 x 27.5	SOP	CL/S

**1.27MM PITCH**

Part Number	Pin Count	IC Body A	IC Socket and Lid Size B (max.)	IC Tip-to-Tip C	Socket Dimensions D x E	Package Type	Note
IC51-0082-1024	8	5.20	7.20	7.90	18.5 x 32.5	SOP	CL/FB
IC51-0082-763	8	4.10	5.4	6.00	14.0 x 30.0	SOP	CL/S
IC51-0142-1013-**	14	5.20	7.20	7.90	18.5 x 32.5	SOP	CL/FB
IC189-0162-003	16	5.30	-	7.80	20.9 x 15.8	SOP	OT
IC189-0162-019	16	5.60	-	7.70	20.8 x 16.0	SOP	OT
IC51-0162-1025	16	5.20	7.20	7.90	18.5 x 32.5	SOP	CL/FB
IC51-0162-1035	16	4.00	5.40	6.00	22.0 x 27.2	SOP	CL/S
IC51-0162-1042	16	4.00	5.40	6.00	22.0 x 27.2	SOP	CL/S
IC51-0162-150	16	4.50	4.90	6.40	26.0 x 35.0	SOP	CL/S
IC51-0162-271-1	16	5.50	5.22	8.00	13.0 x 28.5	SOP	CL/S
IC51-0162-273-1	16	4.50	5.22	8.00	13.0 x 28.5	SOP	CL/S
IC51-0162-272-1	16	5.50	5.72	8.00	13.0 x 28.5	SOP	CL/S
IC51-0162-273*	16	5.50	6.22	8.00	13.0 x 28.5	SOP	CL/S
IC51-0162-302-**	16	5.35	7.20	7.80	12.0 x 30.5	SOP	CL/S
IC51-0162-658	16	4.40	5.70	7.00	26.0 x 31.5	SOP	CL/S
IC51-0162-902-2	16	5.30	7.20	8.20	12.0 x 28.5	SOP	CL/S

**1.27MM PITCH (CONT'D)**

Part Number	Pin Count	IC Body A	IC Socket and Lid Size B (max.)	IC Tip-to-Tip C	Socket Dimensions D x E	Package Type	Note
IC189-0202-017N	20	5.60	-	7.70	24.0 x 22.5	SOP	OT
IC51-0202-1026	20	5.20	7.20	7.90	18.5 x 32.5	SOP	CL/FB
IC51-0202-164	20	5.30	6.70	8.50	32.0 x 36.5	SOP	CL/S
IC51-0202-347-*	20	7.70	9.53	10.30	16.0 x 31.5	SOP	CL/S
IC51-0202-714-**	20	7.60	9.30	10.30	18.0 x 32.0	SOP	CL/FB
IC51-0202-932-1	20	5.30	6.50	7.20	15.5 x 26.0	SOP	CL/S
IC51-0222-803-**	22	5.50	6.00	6.60	16.5 x 29.0	SOP	CL/S
IC189-0242-040	24	7.15	-	10.30	24.0 x 22.5	SOP	OT
IC51-0202-1026	20	5.20	7.20	7.90	18.5 x 32.5	SOP	CL/FB
IC51-0202-164	20	5.30	6.70	8.50	32.0 x 36.5	SOP	CL/S
IC51-0202-347	20	7.70	9.53	10.30	16.0 x 31.5	SOP	CL/S
IC51-0202-714	20	7.60	9.30	10.30	18.0 x 32.0	SOP	CL/FB
IC51-0242-303-1	24	5.30	7.30	8.00	18.0 x 28.5	SOP	CL/S
IC51-0242-367-1	24	9.40	10.43	11.20	18.0 x 32.5	SOP	CL/S
IC51-0242-793	24	5.50	7.10	8.00	18.5 x 29.0	SOP	CL/S
IC51-0242-980	24	5.20	7.20	7.90	18.5 x 32.5	SOP	CL/FB
IC51-0262-1339	26	7.60	8.40	9.20	23.0 x 35.5	SOP	CL/FB
IC189-0282-042	28	7.15	-	10.30	24.0 x 22.5	SOP	OT
IC51-0282-165	28	7.40	8.40	9.40	40.0 x 50.0	SOP	CL/S
IC51-0282-334-**	28	7.50	9.40	10.30	22.0 x 32.5	SOP	CL/S
IC51-0282-474	28	8.45	11.10	12.00	22.0 x 32.5	SOP	CL/S
IC51-0282-474-2	28	8.45	10.70	12.00	22.0 x 32.5	SOP	CL/S
IC51-0282-986	28	7.60	9.60	10.30	23.0 x 35.5	SOP	CL/FB
IC51-0302-371-1	30	7.80	9.60	10.30	24.0 x 32.5	SOP	CL/S
IC51-0302-904	30	7.80	9.20	10.30	24.0 x 32.5	SOP	CL/S
IC189-0322-004	32	11.40	-	14.10	27.2 x 26.5	SOP	OT
IC189-0322-005	32	11.00	-	14.00	27.2 x 27.5	SOP	OT
IC51-0322-304-*	32	8.40	11.00	12.00	24.0 x 32.5	SOP	CL/S
IC51-0322-667-*	32	11.60	13.10	14.00	26.0 x 33.0	SOP	CL/S
IC51-0322-937	32	8.80	10.90	12.00	26.0 x 31.5	SOP	CL/S
IC51-0322-950	32	11.30	13.00	15.00	28.0 x 42.5	SOP	CL/FB
IC51-0402-1197	40	10.90	12.90	13.70	20.0 x 52.0	SOP	CL/S
IC51-0402-991	40	11.60	13.00	14.00	30.0 x 34.5	SOP	CL/S
IC189-0442-065 *	44	13.20	-	16.00	29.11 x 34.10	SOP	OT
IC51-0442-1208	44	12.80	14.70	15.60	22.0 x 55.0	SOP	CL/S
IC51-0442-1315	44	13.00	15.00	15.80	33.0 x 40.5	SOP	CL/FB
IC51-0442-1536	44	13.40	14.70	15.60	22.0 x 55.0	SOP	CL/S

Table shows only a selection of sockets available. For customised or other socket types, please contact Yamaichi Electronics

**SERIES IC51 (CLAMSHELL - TH) - 0.40MM TO 1.27MM  
QFP, PQFP, TQFP AND MQUAD®**

**SPECIFICATIONS**

Insulation Resistance:	1,000MΩ min. at 500V DC
Dielectric Withstanding Voltage:	for 1 minute (socket depended)
Contact Resistance:	30mΩ max. at 10mA/20mV max.
Operating Temperature Range:	-40°C to +150°C (for type PEI/PSF) -55°C to +170°C (for type PES) -55°C to +170°C (for type PEI)
Mating Cycles:	10,000 insertions min.

**MATERIALS AND FINISH**

Housing:	Polysulphone (PSF), glass-filled Polyethersulphone (PES), glass-filled Polyetherimide (PEI), glass-filled
Contacts:	Beryllium Copper (BeCu)
Plating:	Gold over Nickel



**PART NUMBER**

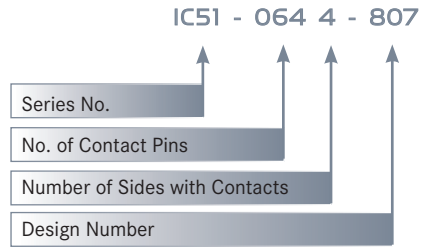

As specifications for this product differ by pitch and material-mix, please contact Yamaichi for detailed information.

**SERIES IC357 AND IC402 (OPEN TOP - TH) - 0.40MM TO 0.65MM  
QUAD FLAT PACKAGE (QFP) WITH 2-POINT CONTACT TYPE**

**SPECIFICATIONS**

Insulation Resistance:	1,000MΩ min. at 100V DC, pitch 0.4 to 0.8
Dielectric Withstanding Voltage:	100V AC for 1 minute, pitch 0.5 to 0.8
Contact Resistance:	30mΩ max. at 10mA/20mV max.
Contact Force:	20g to 70g per pin
Contact Force Signal Pin:	44mN (45g) per pin
Contact Force Ground Pin:	340 ~ 690mN (35 ~ 70gf) per pin
Operating Temperature Range:	-40°C to +150°C
Mating Cycles:	10,000 insertions min.

**MATERIALS AND FINISH**

Housing:	Polyetherimide (PEI), glass-filled Polyethersulphone (PES) glass-filled
Contacts:	Beryllium Copper (BeCu)
Plating:	Gold over Nickel



**PART NUMBER**

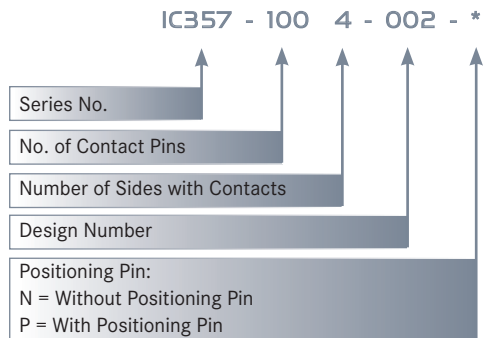

**FEATURES FOR IC357 WITH GROUND PIN**

- Suitable for QFP up to 180°C
- 0.40 to 0.65mm pitch, 1 central GND + 4 signal pins for ePad contact
- Suitable for package leads with limited plating (μ-PPF)

**SERIES IC234 (OPEN TOP - TH) - 0.4MM TO 0.8MM  
QUAD FLAT PACKAGE (QFP) WITH SHOULDER CONTACT TYPE**

**SPECIFICATIONS**

Insulation Resistance:	1,000MΩ min. at 100V DC pitch 0.4, 0.5 1,000MΩ min. at 500V DC pitch 0.65, 0.8
Dielectric Withstanding Voltage:	100V AC for 1 minute pitch 0.4, 0.5 500V AC for 1 minute pitch 0.65 700V AC for 1 minute pitch 0.8
Contact Resistance:	30mΩ max. at 10mA/20mV max.
Operating Temperature Range:	-40°C to +150°C
Contact Force:	20g to 80g per pin
Mating Cycles:	10,000 insertions min.

**MATERIALS AND FINISH**

Housing:	Polyetherimide (PEI), glass-filled Polyethersulphone (PES) glass-filled
Contacts:	Beryllium Copper (BeCu)
Plating:	Gold over Nickel

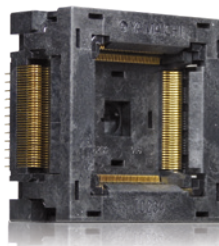

**PART NUMBER**

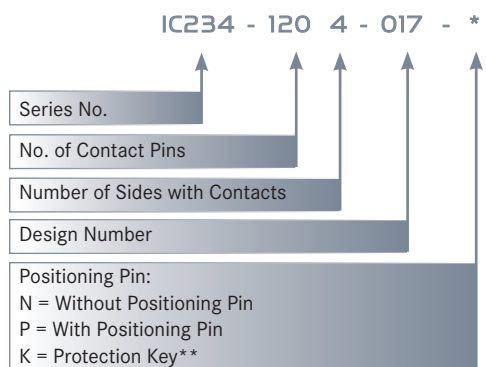

\*\* Protection Key: Prevents IC from releasing during transportation

**SERIES IC200 / IC201 / IC217 / IC218 / IC248 (OPEN TOP - TH) - 0.40MM TO 0.80MM QUAD FLAT PACKAGES (QFP)**

**SPECIFICATIONS**

Insulation Resistance:	1,000MΩ min. at 500V DC or 1,000MΩ min. at 100V DC
Dielectric Withstanding Voltage:	100/500/700V AC for 1 minute
Contact Resistance:	30mΩ max. at 10mA/20mV max.
Operating Temperature Range:	-40°C to +170°C and -40°C to +150°C
Contact Force:	20g to 80g per pin
Mating Cycles:	10,000 insertions min.

The information above is typical for this Series for individual specifications please contact Yamaichi

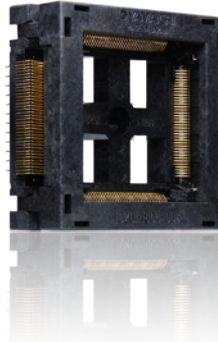

**MATERIALS AND FINISH**

Housing:	Polyetherimide (PEI), glass-filled Polyphenylenesulfide (PPS), glass-filled
Contacts:	Beryllium Copper (BeCu)
Plating:	Gold over Nickel

**PART NUMBER**

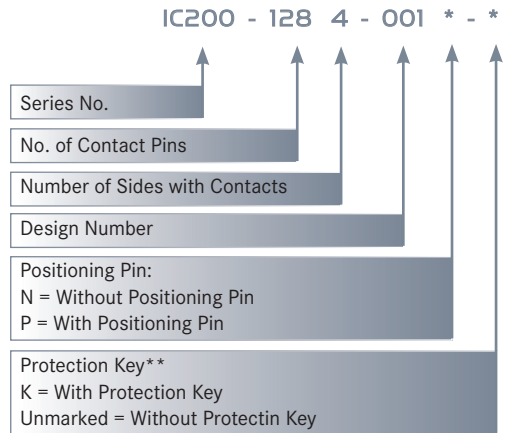

\*\* Protection Key: Prevents IC from releasing during transportation

**SERIES IC500 (OPEN TOP - TH) - 0.50MM TO 0.65MM QUAD FLAT PACKAGE (QFP) WITH 2-POINT CONTACT TYPE**

**SPECIFICATIONS**

Insulation Resistance:	1,000MΩ min. at 100V DC pitch 0.5 1,000MΩ min. at 500V DC pitch 0.65, 0.8
Dielectric Withstanding Voltage:	100V AC for 1 minute pitch 0.5 500V AC for 1 minute pitch 0.65 700V AC for 1 minute pitch 0.8
Contact Resistance:	30mΩ max. at 10mA/20mV max.
Operating Temperature Range:	-40°C to +150°C
Contact Force:	20g to 80g per pin
Mating Cycles:	10,000 insertions min.

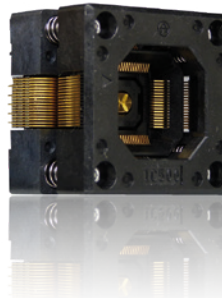

**MATERIALS AND FINISH**

Housing:	Polyetherimide (PEI), glass-filled Polyethersulphone (PES) glass-filled
Contacts:	Beryllium Copper (BeCu)
Plating:	Gold over Nickel

**PART NUMBER**

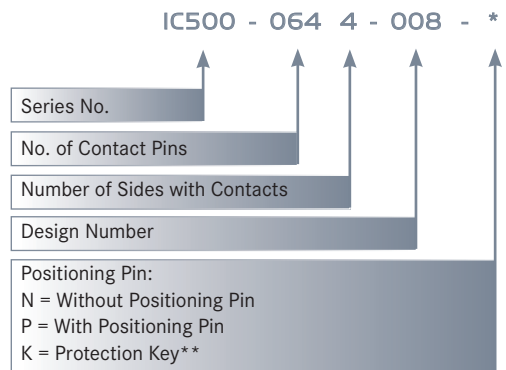

\*\* Protection Key: Prevents IC from releasing during transportation

INFO: Various types with movable GND pin options available

**CONTACT STYLES**

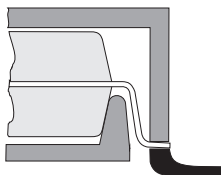

SERIES IC51

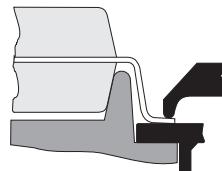

SERIES IC357 / IC402

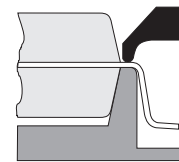

SERIES IC234

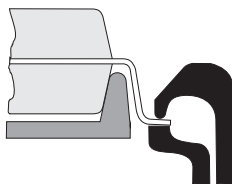

SERIES IC (KELVIN)

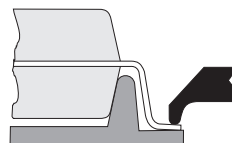

SERIES IC2\*\*

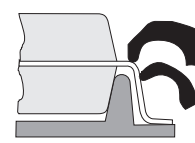

SERIES IC500

\*QFP variations e.g. BQFP..

Outline IC Package Dimensions

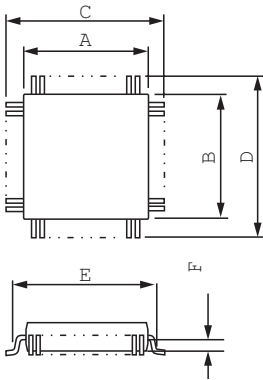

Outline Open Top Socket Dimensions

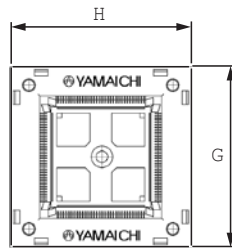

Outline Clamshell Socket Dimensions

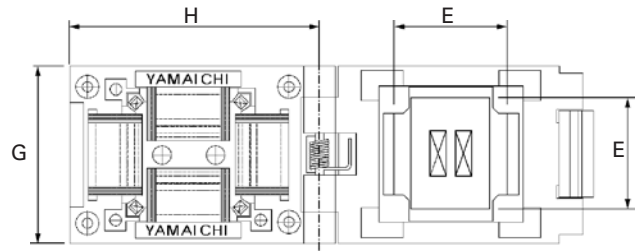

C L = Clamshell, OT = Open Top

**0.40MM PITCH**

Part Number	Pin Count	IC Body A x B	IC Tip-to-Tip C x D	Parallel Clamp E	∅ GND Pin Hole	1/2 IC Height F	Socket Dim. G x H	Type
IC357-0804-134*	56	10.0 x 10.0	12.0 x 12.0	-	2.0	0.4275	22.0 x 22.0	OT
IC51-0644-1972	64	7.0 x 7.0	9.0 x 9.0	8.25	-	-	35.0 x 32.0	OT
IC234-0804-055-P-2	80	10.0 x 10.0	12.0 x 12.0	-	-	0.7375	30.0 x 30.0	OT
IC234-1004-045-*	100	12.0 x 12.0	14.0 x 14.0	-	-	0.56	35.0 x 32.0	OT
IC357-1004-135*	100	12.0 x 12.0	14.0 x 14.0	-	3.0	0.4275	24.0 x 24.0	OT
IC51-1004-1919-*	100	12.0 x 12.0	14.0 x 14.0	13.30	-	-	36.0 x 42.5	CL
IC234-1204-022-*	120	14.0 x 14.0	16.0 x 16.0	-	-	0.762	34.0 x 34.0	OT
IC51-1204-1596	120	14.0 x 14.0	16.0 x 16.0	15.35	-	-	36.0 x 42.5	CL
IC51-1204-1812	120	14.0 x 14.0	16.0 x 16.0	-	-	-	36.0 x 42.5	CL
IC234-1284-043*-*	128	14.0 x 14.0	16.0 x 16.0	-	-	0.56	34.0 x 34.0	OT
IC357-1284-056P	128	14.0 x 14.0	16.0 x 16.0	-	-	0.65	34.0 x 34.0	OT
IC357-1284-076P	128	14.0 x 14.0	16.0 x 16.0	-	-	0.45	34.0 x 34.0	OT
IC51-1284-1702-*	128	14.0 x 14.0	16.0 x 16.0	15.40	-	-	36.0 x 42.5	CL
IC51-1284-1788	128	14.0 x 14.0	16.0 x 16.0	15.30	-	0.70	39.0 x 42.5	CL
IC234-1444-053P-2	144	16.0 x 16.0	18.0 x 18.0	-	-	0.54	36.0 x 36.0	OT
IC357-1444-131*-*	144	16.0 x 16.0	18.0 x 18.0	-	3.5	0.4275	28.0 x 28.0	OT
QFP11T144-001	144	16.0 x 16.0	18.0 x 18.0	17.20	-	-	39.0 x 42.5	CL
IC357-1564-150*-*	156	14.0 x 20.0	22.0 x 16.0	-	3.5	0.6275	38.0 x 32.0	OT
IC234-1564-038P-2	156	14.0 x 14.0	16.0 x 16.0	-	-	0.76	38.0 x 44.0	OT
IC234-1764-059P	176	20.0 x 20.0	22.0 x 22.0	-	-	0.67	40.0 x 40.0	OT
IC51-1764-1995	176	14.0 x 20.0	22.0 x 22.0	21.30	-	-	46.0 x 50.0	CL
IC51-1764-1995-6	176	20.0 x 20.0	22.0 x 22.0	21.20	-	-	46.0 x 50.0	CL
IC234-2164-050-*	216	20.0 x 20.0	26.0 x 26.0	-	-	0.67	44.0 x 44.0	OT
IC234-2164-066	216	20.0 x 20.0	26.0 x 26.0	-	-	0.67	44.0 x 44.0	OT
IC51-2164-1887-*	216	24.0 x 24.0	26.0 x 26.0	25.30	-	-	50.0 x 48.0	CL
IC234-2564-078-*	256	24.0 x 24.0	30.0 x 30.0	-	-	0.67	48.0 x 48.0	OT
IC51-2564-1668	256	28.0 x 28.0	31.2 x 31.2	30.00	-	-	56.0 x 62.0	CL
IC51-2564-1668-10	256	28.0 x 28.0	30.0 x 30.0	29.40	-	-	56.0 x 62.0	CL
IC51-2564-1668-6	256	27.2 x 27.2	29.8 x 29.8	30.00	-	-	56.0 x 62.0	CL
IC51-2564-1668-8	256	28.0 x 28.0	30.6 x 30.6	30.00	-	-	56.0 x 62.0	CL

**0.50MM PITCH**

Part Number	Pin Count	IC Body A x B	IC Tip-to-Tip C x D	Parallel Clamp E	∅ GND Pin Hole	1/2 IC Height F	Socket Dim. G x H	Type
IC51-0324-805-*	32	5.0 x 5.0	7.0 x 7.0	6.20	-	-	28.0 x 31.0	CL
IC357-0484-143*-*	48	7.0 x 7.0	9.0 x 9.0	-	1.2	0.6135	25.0 x 25.0	OT
IC234-0484-034-*	48	7.0 x 7.0	9.0 x 9.0	-	-	0.47	26.6 x 26.6	OT
IC234-0484-039-*	48	7.0 x 7.0	9.0 x 9.0	-	-	0.74	26.6 x 26.6	OT
IC357-0484-078	48	7.0 x 7.0	9.0 x 9.0	-	-	0.45	22.0 x 22.0	OT
IC51-0484-806-*	48	7.0 x 7.0	9.0 x 9.0	8.20	-	-	29.0 x 32.0	CL
IC201-0644-003	64	10.0 x 10.0	12.0 x 12.0	-	-	0.70	30.0 x 36.0	OT
IC201-0644-040	64	10.0 x 10.0	12.0 x 12.0	-	-	0.67	28.7 x 28.7	OT
IC234-0644-027-*	64	10.0 x 10.0	12.0 x 12.0	-	-	0.66	29.6 x 29.6	OT
IC234-0644-122-*	64	10.0 x 10.0	12.0 x 12.0	-	-	0.66	29.6 x 29.6	OT

cont'd next page

**0.50MM PITCH (CONT'D)**

Part Number	Pin Count	IC Body A x B	IC Tip-to-Tip C X D	Parallel Clamp E	∅ GND Pin Hole	1/2 IC Height F	Socket Dim. G x H	Type
IC357-0644-06**-*	64	10.0 x 10.0	12.0 x 12.0	-	-	0.6375	26.2 x 26.2	OT
IC500-0644-008P	64	10.0 x 10.0	12.0 x 12.0	-	-	0.67	29.6 x 29.6	OT
IC357-1644-126*	64	10.0 x 10.0	12.0 x 12.0	-	3.0	0.7125	27.9 x 27.9	OT
IC51-0644-807*	64	10.0 x 10.0	12.0 x 12.0	11.30	-	-	32.0 x 35.0	CL
IC357-084-128**-*	80	12.0 x 12.0	14.0 x 14.0	-	3.0	0.6375	29.0 x 29.0	OT
IC201-0804-014	80	12.0 x 12.0	14.0 x 14.0	-	-	0.62	29.0 x 29.0	OT
IC234-0804-011**-*	80	12.0 x 12.0	14.0 x 14.0	-	-	0.45	29.0 x 29.0	OT
IC234-0804-026**-*	80	12.0 x 12.0	14.0 x 14.0	-	-	0.67	31.6 x 31.6	OT
IC357-0804-074P-1	80	12.0 x 12.0	14.0 x 14.0	-	-	0.6375	29.0 x 29.0	OT
IC357-0804-096	80	12.0 x 12.0	14.0 x 14.0	-	-	0.6375	29.0 x 29.0	OT
IC51-0804-808*	80	12.0 x 12.0	14.0 x 14.0	13.30	-	-	34.0 x 37.0	CL
IC201-1004-008	100	14.0 x 14.0	16.0 x 16.0	-	-	0.60	32.2 x 31.0	OT
IC201-1004-043**-*	100	14.0 x 14.0	16.0 x 16.0	-	-	0.45	31.0 x 31.0	OT
IC234-1004-023**-*	100	14.0 x 14.0	16.0 x 16.0	-	-	0.67	33.6 x 33.6	OT
IC357-1004-105**-*	100	14.0 x 14.0	16.0 x 16.0	-	4.0	0.6250	31.9 x 31.9	OT
IC357-1004-120**-*	100	14.0 x 14.0	16.0 x 16.0	-	2.8	0.4275	31.9 x 31.9	OT
IC357-1004-123**-*	100	14.0 x 14.0	16.0 x 16.0	-	3.0	0.6250	31.9 x 31.9	OT
IC357-1004-146**-*	100	14.0 x 14.0	16.0 x 16.0	-	2.8	0.4270	26.0 x 26.0	OT
IC357-1004-***	100	14.0 x 14.0	16.0 x 16.0	-	-	0.55	31.9 x 31.9	OT
IC402-1004-002P	100	14.0 x 20.0	16.0 x 22.0	-	-	0.70	29.8 x 23.8	OT
IC500-1004-004*	100	14.0 x 14.0	16.0 x 16.0	-	-	0.68	33.6 x 33.6	OT
IC51-1004-809*	100	14.0 x 14.0	16.0 x 16.0	15.30	-	-	39.0 x 39.0	CL
IC234-1204-058 *	120	16.0 x 16.0	18.0 x 18.0	-	-	0.67	35.6 x 35.6	OT
IC248-1284-007 **-*	128	14.0 x 20.0	16.0 x 22.0	-	-	0.67	37.4 x 43.4	OT
IC357-1284-033P	128	14.0 x 20.0	22.0 x 22.0	-	-	1.10	31.0 x 37.0	OT
IC500-1284-009P	128	14.0 x 20.0	16.0 x 22.0	-	-	0.625	33.6 x 39.6	OT
IC201-1444-026*-2	144	20.0 x 20.0	22.0 x 22.0	-	-	0.69	37.0 x 37.0	OT
IC357-1444-147**-*	144	20.0 x 20.0	22.0 x 22.0	-	4.0	0.4280	32.0 x 32.0	OT
IC201-1444-034*	144	20.0 x 20.0	22.0 x 22.0	-	-	0.65	37.0 x 37.0	OT
IC234-1444-016*	144	20.0 x 20.0	22.0 x 22.0	-	-	0.8370	37.0 x 37.0	OT
IC402-1444-003P	144	20.0 x 20.0	22.0 x 22.0	21.30	-	0.80	30.0 x 30.0	OT
IC500-1444-002P-2	144	20.0 x 20.0	22.0 x 22.0	-	-	0.68	37.0 x 37.0	OT
IC51-1444-1354	144	20.0 x 20.0	22.0 x 22.0	21.30	-	1.00	43.0 x 47.0	CL
IC51-1604-1350*	160	24.0 x 24.0	26.0 x 26.0	25.30	-	-	46.0 x 50.0	CL
IC201-1764-033P-2	176	24.0 x 24.0	26.0 x 26.0	-	-	0.67	40.0 x 46.0	OT
IC357-1764-113**-*	176	24.0 x 24.0	26.0 x 26.0	-	6.0	0.6275	46.0 x 46.0	OT
IC234-1764-002*	176	24.0 x 24.0	26.0 x 26.0	-	-	1.00	46.0 x 46.0	OT
IC234-1764-005*	176	24.0 x 24.0	26.0 x 26.0	-	-	1.00	46.0 x 46.0	OT
IC234-1764-121*	176	24.0 x 24.0	26.0 x 26.0	-	-	1.00	40.0 x 46.0	OT
IC357-1764-061P	176	24.0 x 24.0	26.0 x 24.0	-	-	0.615	41.0 x 41.0	OT
IC357-1764-087	176	24.0 x 24.0	26.0 x 24.0	-	-	0.735	41.0 x 41.0	OT
IC51-1764-1505	176	24.0 x 24.0	26.0 x 26.0	25.30	-	0.90	46.0 x 50.0	CL
IC200-2084-009**-*	208	28.0 x 28.0	31.2 x 31.2	-	-	1.40	51.2 x 52.2	OT
IC200-2084-010**-*	208	28.0 x 28.0	30.6 x 30.6	-	-	1.40	50.6 x 50.6	OT
IC201-2084-001	208	28.0 x 28.0	30.0 x 30.0	-	-	1.50	45.0 x 45.0	OT
IC201-2084-029*	208	28.0 x 28.0	30.6 x 30.6	-	-	1.67	45.6 x 45.6	OT
IC201-2084-096P	208	28.0 x 28.0	30.0 x 30.0	-	-	0.55	45.0 x 45.0	OT
IC357-2084-019P-2	208	28.0 x 28.0	30.6 x 30.6	-	-	-	45.6 x 45.6	OT
IC51-2084-1052*	208	28.0 x 28.0	-	-	-	-	52.0 x 58.0	CL
IC51-2084-1509	208	27.7 x 27.7	31.2 x 31.2	29.80	-	-	52.0 x 58.0	CL
IC51-2084-1566	208	28.0 x 28.0	31.2 x 31.2	30.30	-	-	52.0 x 58.0	CL
IC217-2404-007 *	240	32.0 x 32.0	34.6 x 34.6	-	-	1.75	56.1 x 56.1	OT
IC234-2404-030 *	240	32.0 x 32.0	34.6 x 34.6	-	-	2.06	51.6 x 51.6	OT
IC51-2404-1655-2	240	32.0 x 32.0	34.6 x 34.6	33.80	-	-	56.0 x 62.0	CL
IC201-2564-002	256	28.0 x 40.0	30.6 x 40.6	-	-	1.50	45.6 x 57.6	OT
IC51-2724-1727	272	35.9 x 35.9	37.4 x 37.4	37.60	-	-	58.0 x 72.0	CL
IC201-3044-004	304	40.0 x 40.0	42.6 x 42.6	-	-	1.50	57.6 x 57.6	OT
IC51-3044-1471-2	304	39.95 x 39.95	42.6 x 42.6	41.90	-	-	66.0 x 72.0	CL
IC51-3044-1471-5	304	39.64 x 39.64	42.6 x 42.6	41.90	-	-	66.0 x 72.0	CL

 cont'd next page 

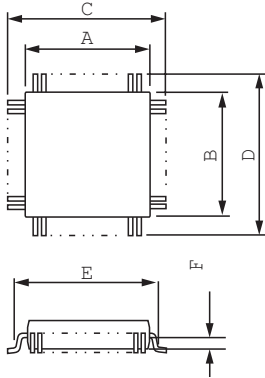
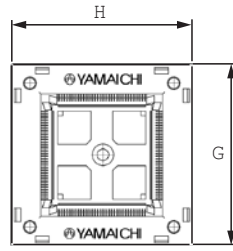
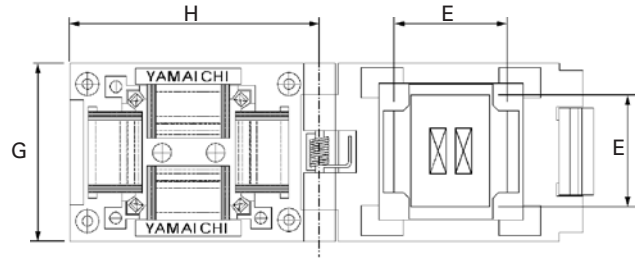

**Outline IC Package Dimensions**

**Outline Open Top Socket Dimensions**

**Outline Clamshell Socket Dimensions**

**0.635MM PITCH**

Part Number	Pin Count	IC Body A x B	IC Tip-to-Tip C x D	Parallel Clamp E	1/2 IC Height F	Socket Dim. G x H	Type
IC51-1004-827	100	22.86 x 22x86	22.35 x 22.35	-	-	47.5 x 34.0	OT
IC211-1324-002 *-*	132	24.10 x 24.10	28.0 x 28.0	-	-	47.4 x 47.4	OT
IC51-1324-828	132	27.94 x 27.94	27.43 x 27.43	-	-	53.5 x 40.0	OT
IC51-1964-1952	196	34.29 x 34.29	58.0 x 58.0	-	-	70.0 x 83.0	OT

**0.65MM PITCH**

Part Number	Pin Count	IC Body A x B	IC Tip-to-Tip C x D	Parallel Clamp E	∅ GND Pin Hole	1/2 IC Height F	Socket Dim. G x H	Type
IC51-0484-652	48	6.0 x 9.0	7.4 x 8.8	7.00	-	-	34.0 x 34.5	CL
QFP11T052-004A102221*	52	10.0 x 10.0	13.2 x 13.2	13.30	-	-	34.0 x 37.0	CL
IC51-0564-680	56	10.0 x 10.0	13.2 x 13.2	11.80	-	-	34.0 x 35.5	CL
IC357-0644-077	64	12.0 x 12.0	14.0 x 14.0	-	-	0.6375	29.0 x 29.0	OT
IC51-0644-1586	64	12.0 x 12.0	15.3 x 15.3	13.90	-	-	36.0 x 39.0	CL
IC51-0644-1602	64	12.0 x 12.0	14.0 x 14.0	13.10	-	-	20.0 x 42.0	CL
IC51-0684-734	68	10.0 x 14.0	13.2 x 17.2	11.80 x 15.80	-	-	37.0 x 41.0	CL
IC201-0804-005	80	14.0 x 20.0	17.9 x 23.9	-	-	1.22	32.9 x 38.9	OT
IC201-0804-012	80	14.0 x 14.0	17.2 x 17.2	-	-	0.92	29.2 x 32.2	OT
IC234-0804-019 *	80	14.0 x 14.0	16.8 x 16.8	-	-	1.35	32.2 x 32.2	OT
IC357-0804-133*-*	80	14.0 x 14.0	16.0 x 16.0	-	4.5	0.63	31.9 x 31.9	OT
IC357-0804-003P	80	14.0 x 14.0	17.2 x 17.2	-	-	0.50	31.9 x 31.9	OT
IC500-0804-005P-2	80	14.0 x 14.0	16.0 x 16.0	-	-	1.07	32.0 x 32.2	OT
IC51-0804-711	80	14.0 x 14.0	17.2 x 17.2	15.80	-	-	37.0 x 41.0	CL
IC51-0804-795	80	14.0 x 14.0	16.0 x 16.0	15.30	-	-	37.0 x 41.0	CL
IC51-0804-956*	80	14.0 x 14.0	17.2 x 17.2	16.40	-	-	34.0 x 42.5	CL
IC201-1004-016	100	14.0 x 20.0	17.9 x 23.9	-	-	1.28	32.9 x 38.9	OT
IC201-1004-028-*	100	14.0 x 20.0	17.2 x 23.2	-	-	1.20	32.2 x 38.2	OT
IC201-1004-050*	100	14.0 x 20.0	16.0 x 22.0	-	-	0.75	31.0 x 37.0	OT
IC234-1004-***-***	100	14.0 x 20.0	16.0 x 22.0	-	-	0.875	31.0 x 37.0	OT
IC51-1004-814*	100	14.0 x 20.0	17.9 x 23.9	17.0 x 23.0	-	-	34.0 x 42.5	CL
IC51-814 KS-12033	100	14.0 x 20.0	17.2 x 23.2	16.4 x 22.4	-	-	34.0 x 42.5	CL
IC234-1124-093 *	112	24.0 x 24.0	23.2 x 23.2	-	-	1.30	38.2 x 38.2	OT
IC500-1124001P-2	112	20.0 x 20.0	22.0 x 22.0	-	-	0.68	38.2 x 38.2	OT
IC51-1124-1036-***	112	20.0 x 20.0	23.2 x 23.2	22.30	-	-	34.0 x 42.5	CL
IC51-1444-1014-*	144	28.0 x 28.0	31.2 x 31.2	30.40	-	-	44.0 x 57.0	CL
IC201-1604-006	160	28.0 x 28.0	31.2 x 31.2	-	-	1.65	46.2 x 46.2	OT
IC234-1604-018 *	160	27.9 x 27.9	32.0 x 32.0	-	-	1.48	47.6 x 47.6	OT
IC234-1604-032 *	160	28.0 x 28.0	30.6 x 30.6	-	-	1.66	47.6 x 47.6	OT
IC51-1604-845-*	160	28.0 x 28.0	31.6 x 31.6	30.60	-	-	44.0 x 57.0	CL
IC51-1604-926	160	29.0 x 29.0	30.2 x 31.4	30.40	-	-	44.0 x 57.0	CL

**0.80MM PITCH**

Part Number	Pin Count	IC Body A x B	IC Tip-to-Tip C x D	Parallel Clamp E	1/2 IC Height F	Socket Dim. G x H	Type
IC234-0324-044-*	32	7.0 x 7.0	9.0 x 9.0	-	0.67	26.6 x 26.6	OT
IC51-0324-1498	32	7.0 x 7.0	9.0 x 9.0	8.4	-	30.0 x 35.5	CL
IC51-0324-354	32	7.4 x 7.4	9.8 x 9.8	8.4	-	30.0 x 37.5	CL
IC234-0444-037 *	44	10.0 x 10.0	12.0 x 12.0	-	0.45	29.6 x 29.6	OT
IC234-0444-054 *	44	9.95 x 9.95	12.8 x 12.8	-	1.35	29.6 x 29.5	OT
IC248-0444-001 *	44	10.0 x 10.0	13.2 x 13.2	-	0.80	27.0 x 27.0	OT
IC51-0444-1195-3	44	10.0 x 10.0	12.6 x 12.6	11.5	-	40.0 x 40.0	CL
IC51-0444-467	44	10.0 x 10.0	13.9 x 13.9	11.5	-	40.0 x 40.0	CL
QFP11T044-001	44	10.0 x 10.0	12.0 x 12.0	11.3	-	32.0 x 35.0	CL
IC51-0444-798	44	10.0 x 10.0	13.9 x 13.9	12.9	-	40.0 x 40.0	CL
IC51-0444-825	44	10.0 x 10.0	12.6 x 12.6	11.8	-	40.0 x 40.0	CL
IC51-0564-924	56	10.0 x 14.0	13.2 x 17.2	11.8 x 15.8	-	37.0 x 41.0	CL
IC51-0604-361	60	16.0 x 16.0	18.3 x 18.3	16.5	-	37.0 x 44.0	CL
IC51-0604-468	60	14.0 x 14.0	17.2 x 17.2	15.8	-	38.0 x 43.0	CL
IC234-0644-024 *	64	14.0 x 14.0	16.8 x 16.8	-	1.40	32.2 x 32.2	OT
IC51-0644-1240-*	64	14.0 x 14.0	16.5 x 16.5	15.0	-	42.5 x 34.0	CL
IC51-0644-692-*	64	14.0 x 14.0	-	-	-	22.0 x 26.0	CL
IC51-0644-824-*	64	14.0 x 14.0	17.2 x 17.2	15.8	-	30.0 x 42.5	CL
IC51-0724-698	72	16.0 x 20.0	18.2 x 23.1	16.6 x 21.5	-	36.0 x 44.5	CL
IC201-0804-032 *	80	14.0 x 20.0	17.2 x 23.2	-	-	38.2 x 38.2	OT
IC218-0804-002	80	14.0 x 20.0	19.2 x 25.2	-	0.95	31.0 x 38.2	OT
IC218-0804-007 *	80	14.0 x 14.0	16.0 x 16.0	-	-	32.2 x 29.2	OT
IC234-0804-001	80	14.0 x 20.0	19.1 x 25.1	-	1.60	32.2 x 32.2	OT
IC51-0804-819-*	80	14.0 x 20.0	17.9 x 23.9	16.9 x 22.9	-	34.0 x 42.5	CL
IC234-1204-017 *	120	28.0 x 28.0	31.2 x 31.2	-	1.70	46.2 x 46.2	OT
IC234-1204-065 *	120	28.0 x 28.0	32.8 x 32.8	-	1.63	48.4 x 48.4	OT
IC51-1204-1497	120	28.0 x 28.0	29.7 x 29.7	30.5	-	60.0 x 58.0	CL
IC51-1204-1646	120	28.0 x 28.0	31.2 x 31.2	30.8	-	57.0 x 30.6	CL
IC200-1284-001 *-*	128	28.0 x 28.0	32.0 x 32.0	-	1.50	52.0 x 52.0	OT
IC51-1284-844-*	128	28.0 x 28.0	31.2 x 31.2	30.6	-	44.0 x 57.0	CL
IC234-017 AC-11315	128	28.0 x 28.0	31.2 x 31.2	-	1.70	34.0 x 34.0	OT
IC51-1284-617	128	29.0 x 29.0	31.2 x 31.2	30.60	-	44.0 x 57.0	CL
IC51-1284-976-*	128	28.0 x 28.0	31.2 x 31.2	30.6	-	44.0 x 57.0	CL

 cont'd next page 

Outline IC Package Dimensions

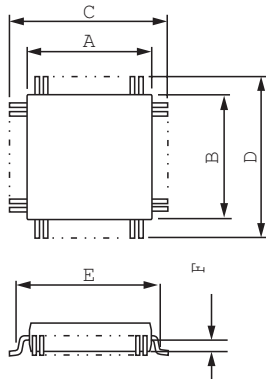

Outline Open Top Socket Dimensions

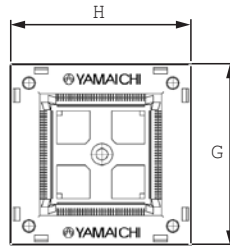

Outline Clamshell Socket Dimensions

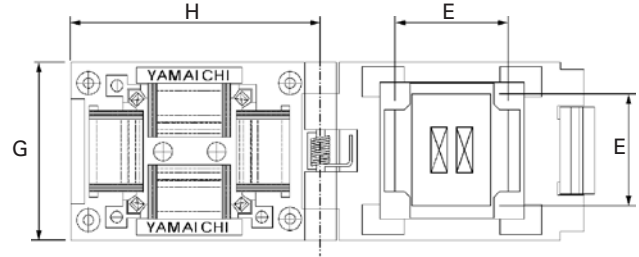

1.00MM PITCH

Part Number	Pin Count	IC Body A x B	IC Tip-to-Tip C x D	Parallel Clamp E	1/2 IC Height F	Socket Dim. G x H	Type
IC51-0444-615	44	14.0 x 14.0	17.2 x 17.2	15.80	-	34.0 x 42.5	CL
IC51-0444-621	44	14.0 x 14.0	17.9 x 17.9	17.00	-	34.0 x 42.5	CL
IC51-0604-497-2	60	16.0 x 20.0	17.9 x 23.9	17.0 x 23.0	-	34.0 x 42.5	CL
IC201-0644-019	64	14.0 x 20.0	17.9 x 23.9	-	1.22	32.9 x 38.9	OT
IC51-0644-472	64	14.0 x 20.0	19.6 x 23.6	16.2 x 22.2	-	34.0 x 42.5	CL
IC51-0644-820-1	64	14.0 x 20.0	18.7 x 24.7	17.0 x 23.0	-	32.9 x 38.9	CL
IC51-0644-820-2	64	14.0 x 20.0	17.6 x 23.6	16.3 x 22.3	-	34.0 x 42.5	CL
IC51-0644-820-3	64	14.0 x 20.0	18.0 x 24.0	16.9 x 22.9	-	34.0 x 42.5	CL
IC51-0644-820-4	64	14.0 x 20.0	17.2 x 23.2	15.8 x 21.8	-	34.0 x 42.5	CL
IC51-820-2 KS-9376	64	14.0 x 20.0	17.2 x 23.2	17.0 x 23.0	-	34.0 x 42.5	CL

All tables show only a selection of sockets available. For customised or other socket types, please contact Yamaichi Electronics

**SPECIFICATIONS**

Insulation Resistance: 1,000MΩ min. at 100V DC  
 Withstanding Voltage: 700V AC for 1 minute  
 Contact Resistance: 30mΩ max. at 10mA/20mV max.  
 Current Resistance: 1A max.  
 Operating Temp.Range: -40°C to +170°C  
 Mating Cycles: 10,000 insertions min.

**PART NUMBER**

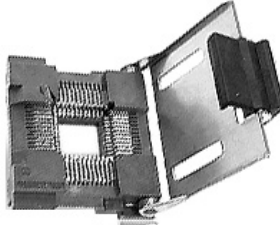
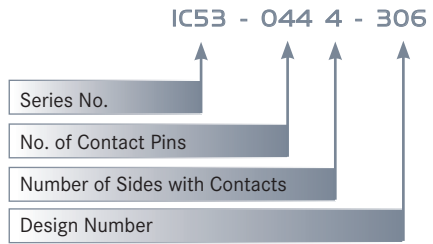

Futher LCC versions are also available.  
 Please contact Yamaichi for more information

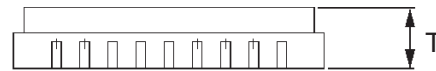
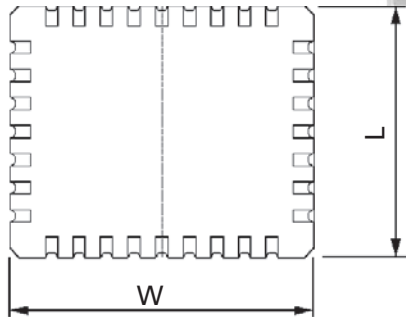

**RECOMMENDED PCB LAYOUTS**

44 pins IC53-0444-306

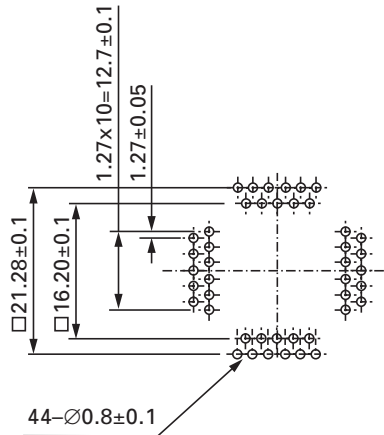

44 pins IC53-0484-100

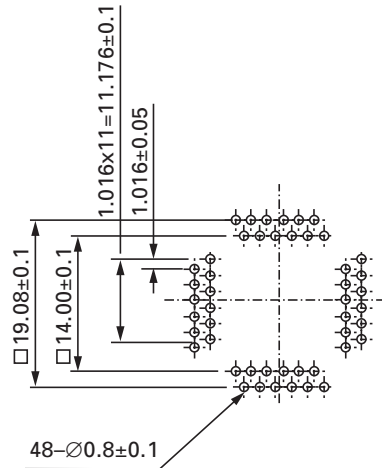

44 pins IC51-0684-498  
 IC-498 AC.17408

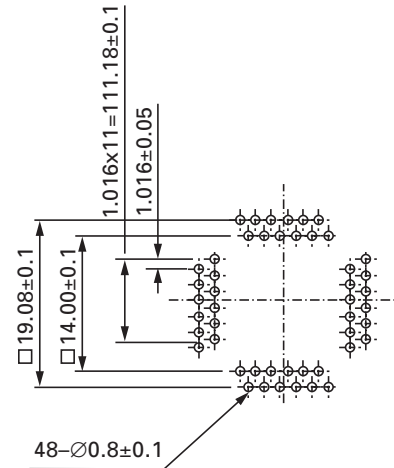

**1.016MM PITCH (40MIL)**

Part Number	Pin Count	IC Dimensions			Contact Position	Socket Material
		W	L	T		
IC53-0484-100	48	14.03 ~ 14.52	14.03 ~ 14.52	1.52 ~ 2.12	13.2 x 13.2	PSF

**1.27MM PITCH**

Part Number	Pin Count	IC Dimensions			Contact Position	Socket Material
		W	L	T		
IC53-0444-306	44	16.31 ~ 16.71	16.31 ~ 16.71	2.50 ~ 3.20	15.4 ~ 15.4	PES
IC51-0684-498	68	23.88 ~ 24.38	23.88 ~ 24.38	1.27 ~ 1.77	23.0 ~ 23.0	PES
IC51-498 AC-17402	68	23.88 ~ 24.38	23.88 ~ 24.38	2.27 ~ 2.80	23.0 ~ 23.0	PES

All tables show only a selection of sockets available. For customised or other socket types, please contact Yamaichi Electronics

**SERIES NP437 / IC511 / IC539 (OPEN TOP AND CLAMSHELL - CMT) - 0.40MM PITCH**  
BGA / CSP / LGA

**SPECIFICATIONS**

Insulation Resistance:	1,000MΩ min. at 100V DC
Dielectric Withstanding Voltage:	100V AC for 1 minute
Contact Resistance:	100mΩ max. at 10mA/20mV max.
Operating Temperature Range:	-40°C to +150°C
Contact Force:	88.2mN ~ 108mN (9 ~ 11gf) per approx.
Actuation Force:	20.0 ~ 29.6N (2 ~ 3kgf)

**MATERIALS AND FINISH**

Housing:	Polyetherimide (PEI), glass-filled Polyethersulphone (PES), glass-filled
Contacts:	Beryllium Copper (BeCu)
Plating:	Gold over Nickel

**FEATURES**

- Compression mount 0.4 to 0.6mm fan-out type
- Depopulation versions available

**PART NUMBER DETAILS**

Please Contact Yamaichi

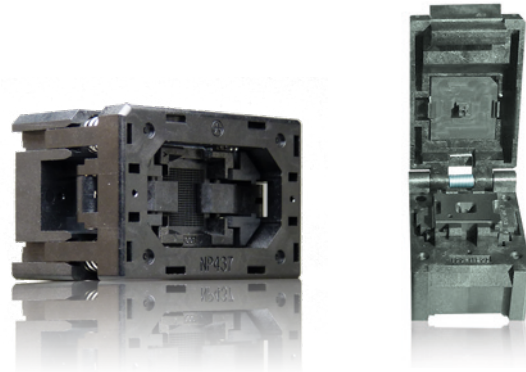

**SERIES IC398 / IC409 (OPEN TOP AND CLAMSHELL - CMT) - 0.50MM PITCH**  
BGA / CSP / LGA

**SPECIFICATIONS**

Insulation Resistance:	1,000MΩ min. at 100V DC
Dielectric Withstanding Voltage:	100V AC for 1 minute
Contact Resistance:	100mΩ max. at 10mA/20mV max.
Operating Temperature Range:	-40°C to +150°C
Contact Force:	78.4mN ~ 98mN (8 ~ 10gf) per pin
Actuation Force:	29.0 ~ 58.8N (3 ~ 6kgf)

**MATERIALS AND FINISH**

Housing:	Polyetherimide (PEI), glass-filled Polyethersulphone (PES), glass-filled
Contacts:	Beryllium Copper (BeCu)
Plating:	Gold over Nickel

**FEATURES**

- Compressed Mount Technology (CMT)
- Depopulation versions available

**PART NUMBER DETAILS**

Please Contact Yamaichi

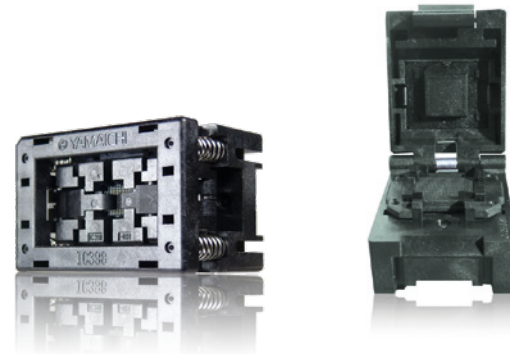

**SERIES NP383 (OPEN TOP - TH) - 0.50MM PITCH**  
BGA / CSP

**SPECIFICATIONS**

Insulation Resistance:	1,000MΩ min. at 500V DC
Dielectric Withstanding Voltage:	500V AC for 1 minute
Contact Resistance:	100mΩ max. at 10mA/20mV max.
Operating Temperature Range:	-40°C to +150°C
Contact Force:	98mN (10gf) per approx.
Actuation Force:	19.6N (2kgf)

**MATERIALS AND FINISH**

Housing:	Polyetherimide (PEI), glass-filled Polyethersulphone (PES), glass-filled
Contacts:	Beryllium Copper (BeCu)
Plating:	Gold over Nickel

**FEATURES**

- 2-point Tweezer Style contact system

**PART NUMBER**

NP383 - \*\*\* - 09 - \*

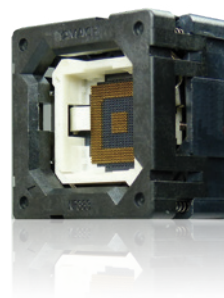
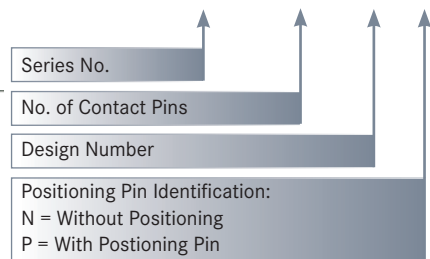

**SERIES IC280 (CLAMSHELL - TH) - 0.65MM TO 1.00MM PITCH**  
BGA / CSP / LGA

**SPECIFICATIONS**

Insulation Resistance:	1,000MΩ min. at 500V DC
Dielectric Withstanding Voltage:	700V AC for 1 minute for 1.00mmpitch
	500V AC for 1 minute for 0.80mm pitch
	100V AC for 1 minute for 0.75mm pitch
Contact Resistance:	100mΩ max. at 10mA/20mV max.
Operating Temperature Range:	-40°C to +150°C
Contact Force:	15g to 35g per pin within contact travel distance between 0.2 to 0.5mm
Mating Cycles:	10,000 insertions

**MATERIALS AND FINISH**

Housing:	Polyetherimide (PEI), glass-filled Polyethersulphone (PES), glass-filled
Contacts:	Beryllium Copper (BeCu)
Plating:	Gold over Nickel



**PART NUMBER**

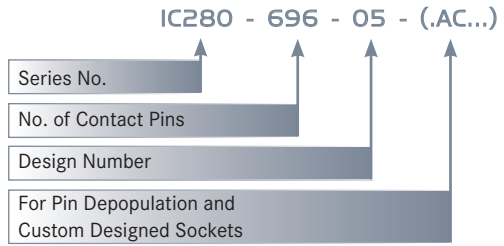

**FEATURES**

- V-shape contact structure to lower the damage of coplanarity of solder balls
- Available in 3 pitch sizes and various depopulation versions, please contact Yamaichi for further available pin counts or custom sockets

**SERIES NP291 (OPEN TOP - TH) - 0.65MM AND 0.75MM PITCH**  
BGA / CSP

**SPECIFICATIONS**

Insulation Resistance:	1,000MΩ min. at 100V DC
Dielectric Withstanding Voltage:	100V AC for 1 minute
Contact Resistance:	100mΩ max. at 10mA/20mV max.
Operating Temperature Range:	-55°C to +170°C
Contact Force:	15g per pin approx.
Mating Cycles:	10,000 insertions

**MATERIALS AND FINISH**

Housing:	Polyetherimide (PEI), glass-filled Polyethersulphone (PES), glass-filled
Contacts:	Beryllium Copper (BeCu)
Plating:	Gold over Nickel

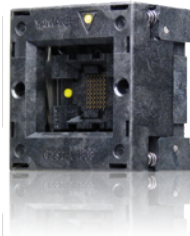

**PART NUMBER**

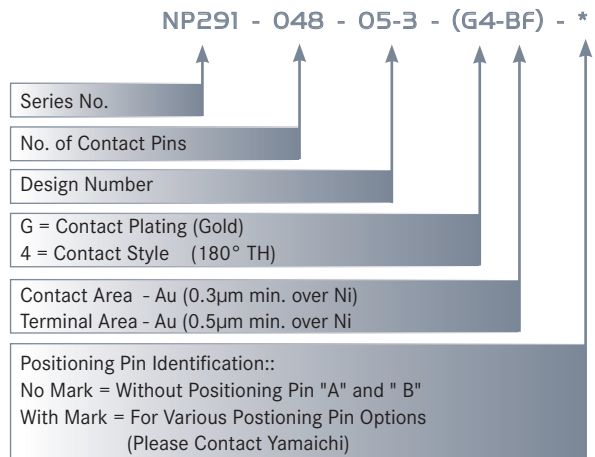

**FEATURES**

- Contacting structure to nip the sides of solder balls to lower damages of coplanarity of solder balls

**SERIES NP556 (OPEN TOP - TH) - 0.80MM PTCH**  
BGA / CSP

**SPECIFICATIONS**

Insulation Resistance:	1,000MΩ min. at 100V DC
Dielectric Withstanding Voltage:	100 V AC for 1 minute
Contact Resistance:	<100mΩ at 20 mV
Operating Temperature Range:	-40°C to +150°C
Contact Force:	~0.0882N (9.0gf) / pin
Mating Cycles:	10,000 insertions min

**MATERIALS AND FINISH**

Housing:	Polyester (PES), glass filled Polyether ether ketone (PEEK)
Contacts:	Beryllium Copper (BeCu)
Plating:	Gold over Nickel

**PART NUMBER**

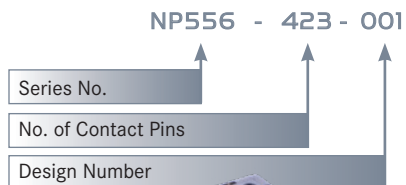

**SERIES NP566 (OPEN TOP - TH) - 0.80MM PITCH**  
BGA / CSP

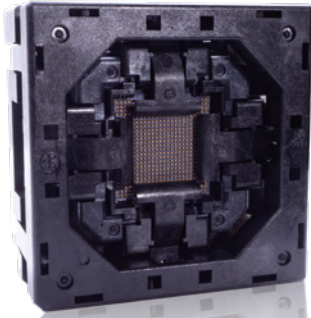

**PART NUMBER**

NP566 - 961 - 005

Series No.

No. of Contact Pins

Design Number

**SPECIFICATIONS**

Insulation Resistance:	1,000MΩ min. at 100V DC
Dielectric Withstanding Voltage:	100V AC for 1 minute
Contact Resistance:	100mΩ max. at
10mA/20mV max.	
Operating Temperature Range:	-40°C to +150°C
Contact Force:	~0.098N (10.0gf) / pin
Mating Cycles:	10,000 insertions min

**MATERIALS AND FINISH**

Housing:	Polyester (PES), glass filled
	Polyether ether ketone (PEEK)
Contacts:	Beryllium Copper (BeCu)
Plating:	Gold over Nickel

**SERIES NP351 (OPEN TOP - TH) - 0.80MM PTCH**  
BGA / CSP / LGA

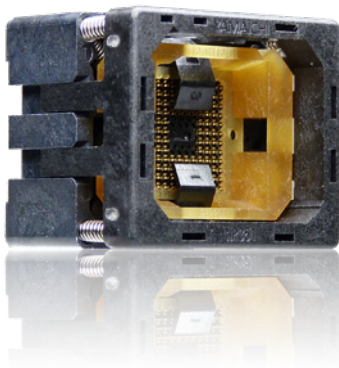

**PART NUMBER**

NP351 - 120 - 14 - (H) - \* - (\*)

Series No.

No. of Contact Pins

Design Number

H = Also for Handler Use

Positioning Pin Options

	Pos. pin "A"	Pos. Pin "B"
1 =	With	With
2 =	With	Without
3 =	Without	With
4 =	Without	Without

Contact Terminal Length and Form

**SPECIFICATIONS**

Insulation Resistance:	1,000MΩ min. at 100V DC
Dielectric Withstanding Voltage:	100V AC for 1 minute
Contact Resistance:	100mΩ max. at 10mA/20mV max.
Operating Temperature Range:	-55°C to +150°C
Contact Force:	15g per pin approx.
Mating Cycles:	10,000 insertions

**FEATURES**

- Self contacting structure without upper pressing force (ZIF)
- 2-point Tweezer Style contact system

**MATERIALS AND FINISH**

Housing:	Polyetherimide (PEI), glass-filled Polyethersulphone (PES), glass-filled
Contacts:	Beryllium Copper (BeCu)
Plating:	Gold over Nickel

**SERIES NP352 / NP483 / NP486 (OPEN TOP - TH) - 1.00MM PITCH**  
BGA / CSP

**SPECIFICATIONS**

Insulation Resistance:	1,000MΩ min. at 100V DC
Dielectric Withstanding Voltage:	100V AC for 1 minute
Contact Resistance:	100mΩ max. at 10mA/20mV max.
Operating Temperature Range:	-40°C to +150°C
Contact Force:	118mN (12gf) per pin approx.
Mating Cycles:	10,000 insertions

**MATERIALS AND FINISH**

Housing:	Polyetherimide (PEI), glass-filled Polyethersulphone (PES), glass-filled
Contacts:	Beryllium Copper (BeCu)
Plating:	Gold over Nickel



**PART NUMBER**

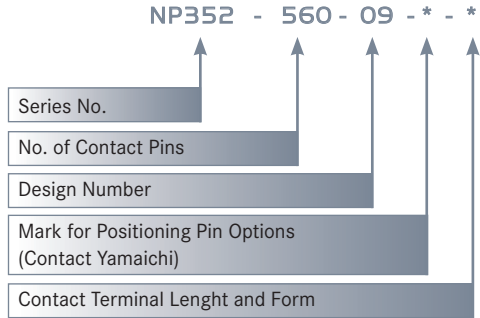

**FEATURES**

- Secure package alignment due to self contacting structure without upper pressing force(ZIF)
- Contacting structure to nip the sides of solder balls to lower damages of coplanarity of solder balls

**SERIES NP276 (OPEN TOP - TH) - 1.27MM PITCH**  
BGA / CSP

**SPECIFICATIONS**

Insulation Resistance:	1,000MΩ min. at 100V DC
Dielectric Withstanding Voltage:	100V AC for 1 minute
Contact Resistance:	100mΩ max. at 10mA/20mV max.
Operating Temperature Range:	-55°C to +150°C
Contact Force:	294 mN (30gf) per pin approx.
Mating Cycles:	10,000 insertions

**MATERIALS AND FINISH**

Housing:	Polyetherimide (PEI), glass-filled Polyethersulphone (PES), glass-filled
Contacts:	Beryllium Copper (BeCu)
Plating:	Gold over Nickel



**PART NUMBER**

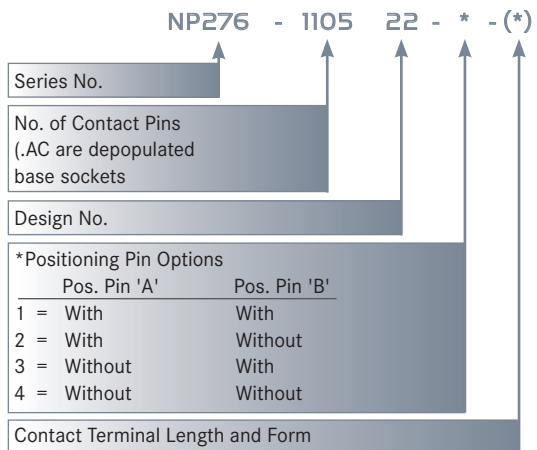

\* for position pin A or B please contact Yamaichi

**FEATURES**

- Open top type sockets for BGA packages
- Secure package alignment due to self contacting structure without upper pressing force (ZIF)
- Contacting structure to nip the sides of solder balls to lower damages of coplanarity of solder balls

**CONTACTING TYPES FOR ALL SERIES**

Since the solder balls are touched by two contacts on each side, the solder ball damage can be minimized; additional features are low actuation force and compact socket size

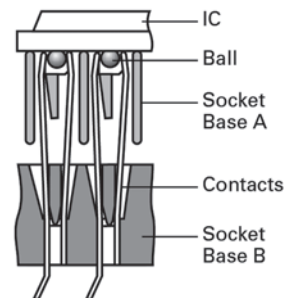
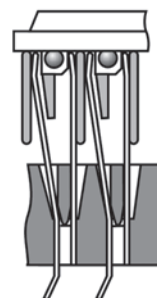
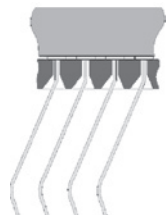

U-Shape Style (BGA)

Bow Style (LGA)

Yamaichi's 2-point Tweezer Style Contact



TYPICAL IC PACKAGE SIZE

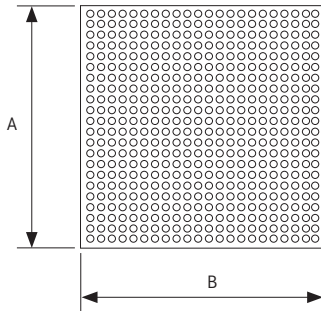

OUTLINE SOCKET DIMENSIONS

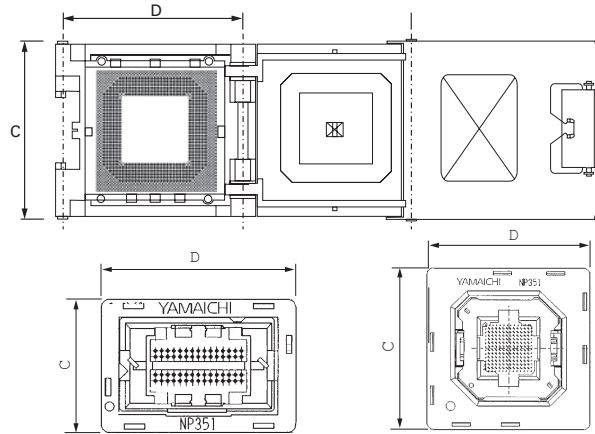

0.40MM PITCH (BASE SOCKETS)

Part Number	Pin Count	Grid Size	Package Size A x B	Socket Size C x D	Lid Type
IC511-*	484 (max.)	up to 22 x 22	up to 11.0 x 11.0	26.0 x 37.0	CL
NP437-*	484 (max.)	up to 22 x 22	up to 10.0 x 10.0	25.0 x 38.0	OT
IC511-*	784 (max.)	up to 28 x 28	up to 12.0 x 12.0	33.0 x 40.0	CL
IC539-*	1024 (max.)	up to 32 x 32	up to 14.0 x 14.0	49.0 x 56.5	CL

0.40MM PITCH

Part Number	Pin Count	Grid Size	Package Size A x B	Socket Size C x D	Lid Type
NP437-048-024	48	8 x 8	4.0 x 4.0	25.0 x 38.0	OT
NP437-065-041	65	9 x 9	4.0 x 4.0	25.0 x 38.0	OT
NP437-112-026	112	11 x 11	5.0 x 5.0	25.0 x 38.0	OT
NP437-124-031	124	12 x 12	5.0 x 5.0	25.0 x 38.0	OT
NP437-196-017	196	14 x 14	6.0 x 6.0	25.0 x 38.0	OT
NP437-256-050	256	16 x 16	7.0 x 7.0	25.0 x 38.0	OT
NP437-260-038	260	18 x 18	8.0 x 8.0	25.0 x 38.0	OT
IC511-515-006	515	28 x 28	12.0 x 12.0	33.0 x 40.0	CL
IC539-683-007	683	33 x 33	14.0 x 14.0	49.0 x 56.5	CL

0.50MM PITCH

Part Number	Pin Count	Grid Size	Package Size A x B	Socket Size C x D	Lid Type
IC398-0064-279	64	8 x 8	5.0 x 5.0	25.0 x 38.0	OT
IC398-0081-253	81	9 x 9	5.0 x 5.0	25.0 x 38.0	OT
IC398-0084-037	84	10 x 10	6.0 x 6.0	25.0 x 38.0	OT
IC409-084-052	84	10 x 10	6.0 x 6.0	26.0 x 37.0	CL
NP383-100-247	100	10 x 10	6.0 x 6.0	19.5 x 26.0	OT
IC409-120-043	120	11 x 11	6.0 x 6.0	26.0 x 37.0	CL
IC398-0121-224	121	11 x 11	6.0 x 6.0	25.0 x 38.0	OT
IC398-0132-144	132	14 x 14	8.0 x 8.0	25.0 x 38.0	OT
IC398-0144-119	144	12 x 12	7.0 x 7.0	25.0 x 38.0	OT

cont'd next page



TYPICAL IC PACKAGE SIZE

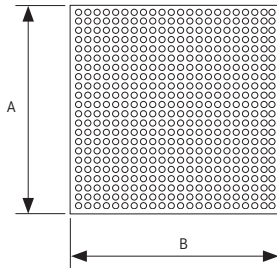

OUTLINE SOCKET DIMENSIONS

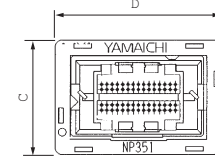
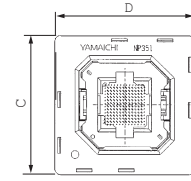
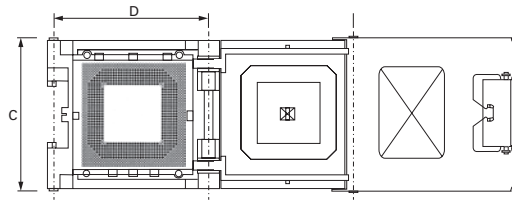

0.50MM PITCH (CONT'D)

Part Number	Pin Count	Grid Size	Package Size A x B	Socket Size C x D	Lid Type
IC398-0144-258	144	12 x 12	7.0 x 7.0	25.0 x 32.0	OT
IC398-0144-223	144	14 x 14	8.0 x 8.0	25.0 x 32.0	OT
IC398-0169-269	169	13 x 13	7.0 x 7.0	25.0 x 32.0	OT
IC398-0191-043	191	16 x 16	9.0 x 9.0	25.0 x 38.0	OT
NP383-200-260	200	27 x 27	14.0 x 14.0	33.0 x 33.0	OT
IC398-0241-198	241	17 x 17	10.0 x 10.0	25.0 x 32.0	OT
IC398-0260-192	260	18 x 18	10.0 x 10.0	25.0 x 32.0	OT
NP383-26006-*-*	260	18 x 18	10.0 x 10.0	36.0 x 36.0	OT
IC398-0268-275	268	18 x 18	10.0 x 10.0	25.0 x 38.0	OT
IC398-0293-120	293	21 x 21	12.0 x 12.0	25.0 x 38.0	OT
IC398-0289-106	289	21 x 21	13.0 x 13.0	27.0 x 41.0	OT
NP383-361-144	361	19 x 19	10.0 x 10.0	28.0 x 28.0	OT
NP383-484-195	484	22 x 22	12.0 x 12.0	33.0 x 33.0	OT

0.65MM PITCH

Part Number	Pin Count	Grid Size	Package Size A x B	Socket Dimensions C x D	Lid Type
NP291-04808-2-G4-BF-P	48	6 x 8	7.58 x 9.81	28.3 x 27.3	OT
NP291-04812-2-G4-BF-P	48	6 x 8	6.50 x 7.91	28.3 x 27.3	OT

0.75MM PITCH

Part Number	Pin Count	Grid Size	Package Size A x B	Socket Dimensions C x D	Lid Type
NP291-04842-2	48	6 x 8	7.0 x 7.0	20.0 x 20.0	OT
NP291-04843-*	48	6 x 8	6.0 x 8.0	20.0 x 20.0	OT
NP291-04848-*	48	6 x 8	6.5 x 6.5	20.0 x 26.0	OT
NP291-04852-P-*	48	6 x 8	12.0 x 9.0	26.0 x 20.0	OT
NP291-05647-P	56	8 x 7	7.0 x 12	33.9 x 24.4	OT
NP291-07210-2.AC-08338	72	8 x 9	7.67 x 16.37	28.4 x 33.9	OT
NP291-07210-2-G4-BF-P	72	8 x 9	7.67 x 16.37	28.4 x 33.9	OT
NP291-16803-1.AC-08229	168	14 x 14	12.0 x 12.0	33.0 x 33.0	OT
NP291-192-092-1	192	14 x 14	12.0 x 12.0	33.0 x 33.0	OT
NP291-28807-1	288	22 x 22	18.0 x 18.0	40.0 x 40.0	OT

**0.80MM PITCH**

Part Number	Pin Count	Grid Size	Package Size A X B	Socket Dimensions C x D	Lid Type
NP351-048-105-*	48	8 x 12	10.95 x 11.95	36 x 36	OT
NP351-048-146-*	48	6 x 8	10 x 11	33 x 33	OT
NP351-048-147-*	48	7 x 8	7 x 11	33 x 33	OT
NP351-048-155-"	48	8 x 8	7.95 x 8.95	36 x 36	OT
NP351-048-165	48	9 x 8	5.95 x 8.95	18 x 22	OT
NP351-048-166-*	48	10 x 8	7 x 7	17.6 x 25.4	OT
NP351-048-216	48	11 x 8	7 x 11	18 x 22	OT
NP351-048-270	48	12 x 8	10 x 11	18 x 22	OT
NP351-048-284	48	13 x 8	6.40 x 7.80	18 x 22	OT
NP351-048-292	48	14 x 8	8 x 10	18 x 22	OT
NP351-056-100	56	8 x 8	9 x 12	18 x 22	OT
NP351-056-104-*	56	10 x 12	7.95 x 11.60	33 x 33	OT
NP351-056-158-*	56	8 x 8	7 x 11	33 x 33	OT
NP351-056-172-1	56	8 x 8	11 x 12	33 x 33	OT
NP351-056-176-1	56	8 x 8	11 x 12	33 x 33	OT
NP351-056-178-1	56	10 x 12	8.0 x 11.6	17.6 x 25.4	OT
NP351-056-219	56	8 x 8	7.0 x 11.0	18 x 22	OT
NP351-056-294	56	8 x 8	8.95	18 x 22	OT
NP351-05673-*	56	8 x 10	8.95	33 x 33	OT
NP351-06094	60	6 x 15	7.83 x 14.76	17.6 x 25.4	OT
NP351-09663 AC-17413	61	10 x 10	9 x 9	36 x 36	OT
NP351-064-148	64	8 x 8	8 x 8	40 x 40	OT
NP351-064-287-*	64	8 x 8	7 x 7	32 x 32	OT
NP351-06444-*	64	8 x 8	8 x 8	36 x 36	OT
NP351-09663 A101115-001	64	10 x 10	9 x 9	36 x 36	OT
NP351-05672-* AC-28445	66	8 x 12	8 x 11	33 x 33	OT
NP351-069-129	69	10 x 10	8 x 11	17.6 x 25.4	OT
NP351-072-174-*	72	8 x 12	8 x 12	17.6 x 25.4	OT
NP351-07296	72	8 x 12	8 x 11	17.6 x 25.4	OT
NP351-05672-* AC-27559	73	10 x 12	8 x 11	33 x 33	OT
NP351-05672-* AC-21998	79	10 x 12	7.95 x 10.95	33 x 33	OT
NP351-080-128	80	9 x 9	8 x 8	18 x 22	OT
NP351-081-169	81	9 x 8	8 x 8	18 x 22	OT
NP351-084-187-1	84	9 x 10	10.95 x 11.95	36 x 36	OT
NP351-09663-*	96	10 x 10	9 x 9	36 x 36	OT
NP351-104 A101033-001	96	8 x 12	7.95 x 11.60	36 x 36	OT
NP351-099-360	99	10 x 10	9 x 12	18 x 22	OT
NP351-206 A100882-001	100	11 x 11	10 x 10	36 x 36	OT
NP351-09663 A100331-001	100	10 x 10	9 x 9	36 x 36	OT
NP351-10889-**-*	108	12 x 12	11 x 11	36 x 36	OT
NP351-11215-*	112	11 x 11	10 x 10	36 x 36	OT
NP351-11230-*	112	11 x 11	10 x 10	33 x 33	OT
NP351-113-277-**-*	113	11 x 11	10 x 10	36 x 36	OT
NP351-116-* AC-20619	121	11 x 11	10 x 10	36 x 36	OT
NP351-121-206-*	121	11 x 11	10 x 10	36 x 36	OT
NP351-12845-*	128	12 x 12	11 x 11	36 x 36	OT
NP351-144-217-*	144	12 x 12	12 x 12	36 x 36	OT
NP351-14422-*	144	13 x 13	12 x 12	36 x 36	OT

 cont'd next page 

TYPICAL IC PACKAGE SIZE

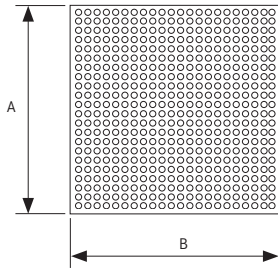

OUTLINE SOCKET DIMENSIONS

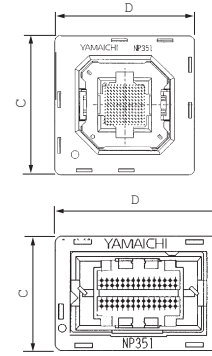
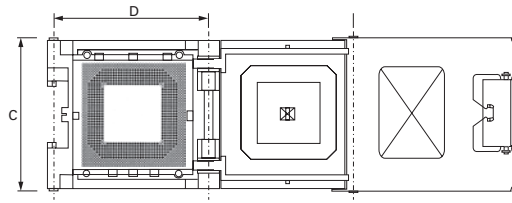

0.80MM PITCH (CONT'D)

Part Number	Pin Count	Grid Size	Package Size A x B	Socket Dimensions C x D	Lid Type
NP351-14429-*	144	13 x 13	12 x 12	33 x 33	OT
NP351-15760-**-*	157	16 x 16	14 x 14	40 x 40	O
NP351-132-**-* AC-27365	160	14 x 14	12 x 12	38 x 38	OT
NP351-132-**-* AC-28179	160	14 x 14	12 x 12	40 x 40	OT
NP351-16092-3-1 AC-17761	161	14 x 14	13 x 13	40 x 40	OT
NP351-17635-*	176	15 x 15	13 x 13	38 x 38	OT
NP351-20881 AC-14017	176	17 x 17	15 x 15	38 x 38	OT
NP351-177-115-*	177	14 x 14	13 x 13	38 x 38	OT
NP351-18464-**-1 AC-20591	179	14 x 14	12 x 12	40 x 40	OT
NP351-180-139-*	180	14 x 14	12 x 12	40 x 40	OT
NP351-18134-* AC-23537	180	14 x 14	13 x 13	40 x 40	OT
NP351-18134-*	181	14 x 14	13 x 13	40 x 40	OT
NP351-184-132-**-*	184	14 x 14	12 x 12	40 x 40	OT
NP351-18464-1-1	184	14 x 14	12 x 12	40 x 40	OT
NP351-19219-*	192	16 x 16	14 x 14	38 x 38	OT
NP351-19602-1	196	14 x 14	12 x 12	33 x 33	OT
IC280-196-126	196	14 x 14	12 x 12	28.40 x 31.35	CS
NP351-20881-1-1	208	17 x 17	15 x 15	40 x 40	OT
NP351-20890-**-*	208	17 x 17	15 x 15	40 x 40	OT
NP351-20897-*	208	17 x 17	15 x 15	40 x 40	OT
NP351-20897-* AC-23539	208	17 x 17	15 x 15	40 x 40	OT
NP351-20897-1 AC-24732	208	17 x 17	15 x 15	40 x 40	OT
NP351-212-207-3-1	212	15 x 15	13 x 13	40 x 40	OT
NP351-21653-3	216	21 x 21	18 x 18	47 x 47	OT
NP351-22405-1	224	18 x 18	16 x 16	38 x 38	OT
NP351-224-134-1-1	224	18 x 18	16 x 16	40 x 40	OT
NP351-135 A101118-001	225	15 x 15	13 x 13	38 x 38	OT
NP351-240-195-1	240	17 x 17	15 x 15	40 x 40	OT
NP351-19219 A100363-001	256	16 x 16	14 x 14	38 x 38	OT
NP351-264-140-1	264	17 x 17	15 x 15	40 x 40	OT
NP351-26457-*	264	25 x 25	21 x 21	47 x 47	OT
NP351-281-234-*	281	17 x 17	15 x 15	40 x 40	OT
NP351-289-191-*	289	17 x 17	15 x 15	40 x 40	OT
NP351-30487-**-*	304	22 x 22	19 x 19	47 x 47	OT
NP351-34031-*	340	22 x 22	20 x 20	47 x 47	OT
NP351-35243-*	352	26 x 26	23 x 23	47 x 47	OT
NP351-400-594-*	400	20 x 20	17 x 17	47 x 47	OT
NP351-532-83-*	532	26 x 26	23 x 23	47 x 47	OT
NP351-532-523	532	25 x 25	23 x 23	40 x 40	OT
NP351-548-352	548	26 x 26	23 x 23	47 x 47	OT
NP351-625-635	625	25 x 25	21 x 21	40 x 40	OT
NP351-676-659	676	26 x 26	23 x 23	40 x 40	OT
IC280-72919	729	13 x 13	23 x 23	46.8 x 47.6	DL

**1.00MM PITCH**

Part Number	Pin Count	Grid Size	Package Size A X B	Socket Dimensions C x D	Lid Type
NP352-165-109	165	11 x 15	13 x 15	23,6 x 29,9	OT
NP352-165-137-*	165	11 x 15	15 x 17	23,6 x 29,9	OT
NP352-196-125	196	14 x 14	15 x 15	31,4 x 34,0	OT
NP352-208-200	208	16 x 16	17 x 17	39,0 x 39,0	OT
NP352-256-81-*	256	16 x 16	17 x 17	39,0 x 39,0	OT
NP486-268-045	268	20 x 20	21 x 21	47,0 x 47,0	OT
NP486-288-010	288	22 x 22	23 x 23	47,0 x 47,0	OT
NP486-320-028	320	20 x 20	21 x 21	47,0 x 47,0	OT
NP352-324-116	324	18 x 18	19 x 19	47,0 x 47,0	OT
NP352-98 AC-30689	324	22 x 22	23 x 23	62,0 x 62,0	OT
NP352-34534	345	21 x 21	23 x 23	62,0 x 62,0	OT
NP352-103 AC-29401	352	26 x 26	27 x 27	47,0 x 47,0	OT
NP352-98 A106677-001	379	22 x 22	23 x 23	62,0 x 62,0	OT
NP352-103 AC-29397	388	26 x 26	27 x 27	47,0 x 47,0	OT
NP352-98 A102213-002	388	22 x 22	23 x 23	62,0 x 62,0	OT
NP486-388-030	388	26 x 26	27 x 27	47,0 x 47,0	OT
NP352-40025	400	29 x 29	31 x 31	62,0 x 62,0	OT
NP352-400-40	400	25 x 25	27 x 27	62,0 x 62,0	OT
NP483-416-062	416	30 x 30	31 x 31	47,0 x 47,0	OT
NP486-416-035	416	26 x 26	27 x 27	47,0 x 47,0	OT
NP352-436-68	436	33 x 33	35 x 35	62,0 x 62,0	OT
NP352-456-66	456	26 x 26	27 x 27	62,0 x 62,0	OT
NP352-484-87-**-*	484	26 x 26	31 x 31	47,0 x 47,0	OT
NP352-484-98	484	22 x 22	23 x 23	62,0 x 62,0	OT
NP486-484-021	484	22 x 22	23 x 23	47,0 x 47,0	OT
NP486-484-040	484	26 x 26	27 x 27	47,0 x 47,0	OT
NP486-516-020	516	26 x 26	27 x 27	47,0 x 47,0	OT
NP486-520-032	520	26 x 26	27 x 27	47,0 x 47,0	OT
NP486-544-027	544	26 x 26	27 x 27	47,0 x 47,0	OT
NP483-561-042	561	27 x 27	29 x 29	47,0 x 47,0	OT
NP352-568-195	568	30 x 30	31 x 31	50,0 x 50,0	OT
NP352-115523 AC-20603	580	34 x 34	35 x 35	62,0 x 62,0	OT
NP486-596-026	596	26 x 26	27 x 27	47,0 x 47,0	OT
NP483-648-039	648	33 x 33	35 x 35	47,0 x 47,0	OT
NP352-659-209	659	30 x 30	31 x 31	50,0 x 50,0	OT
NP352-78832.AC-19367	660	38 x 38	40 x 40	62,0 x 62,0	OT
NP352-676-103	676	26 x 26	27 x 27	47,0 x 47,0	OT
NP352-115523.AC-22615	680	34 x 34	35 x 35	62,0 x 62,0	OT
NP352-152124 AC-19435	680	39 x 39	40 x 40	62,0 x 62,0	OT
IC280-69605	696	38 x 38	40 x 40	56,20 x 54,90	DL
NP352-724-95	724	34 x 34	35 x 35	62,0 x 62,0	OT
IC280-72918	729	27 x 27	28 x 28	46,80 x 47,60	DL
NP352-736-172	736	34 x 34	35 x 35	62,0 x 62,0	OT
NP352-87-1-1.AC-28845	764	30 x 30	31 x 31	47,0 x 47,0	OT
NP483-780-045-*	780	28 x 28	29 x 29	62,0 x 62,0	OT
NP352-152124.AC-25245	792	39 x 39	40 x 40	62,0 x 62,0	OT
NP352-829-133	829	39 x 39	40 x 40	62,0 x 62,0	OT
NP483-844-061	844	34 x 34	35 x 35	62,0 x 62,0	OT
NP352-888-58	888	43 x 43	45 x 45	74,0 x 74,0	OT
NP483-899-022	899	30 x 30	32 x 32	62,0 x 62,0	OT
NP352-87 A101832-*	900	30 x 30	31 x 31	50,0 x 50,0	OT
NP483-900-025	900	30 x 30	31 x 31	62,0 x 62,0	OT
NP483-933-057-*	933	33 x 33	35 x 35	62,0 x 62,0	OT
NP352-115523	1155	34 x 34	35 x 35	62,0 x 62,0	OT
NP352-1296-52	1296	36 x 36	37,5 x 37,5	74,0 x 74,0	OT
NP352-53 A101407-001	1397	39 x 39	40 x 40	62,0 x 62,0	OT
NP483-1444-034-1-*	1444	38 x 38	40 x 40	62,0 x 62,0	OT
NP352-1521-53	1521	39 x 39	40 x 40	62,0 x 62,0	OT
NP483-1521-001	1521	39 x 39	40 x 40	62,0 x 62,0	OT
NP483-1760-008-2-*	1760	42 x 42	42,5 x 42,5	74,0 x 74,0	OT
NP352-1849-35	1849	43 x 43	45 x 45	74,0 x 74,0	OT

cont'd next page

TYPICAL IC PACKAGE SIZE

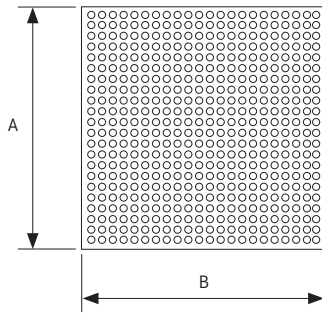

OUTLINE SOCKET DIMENSIONS

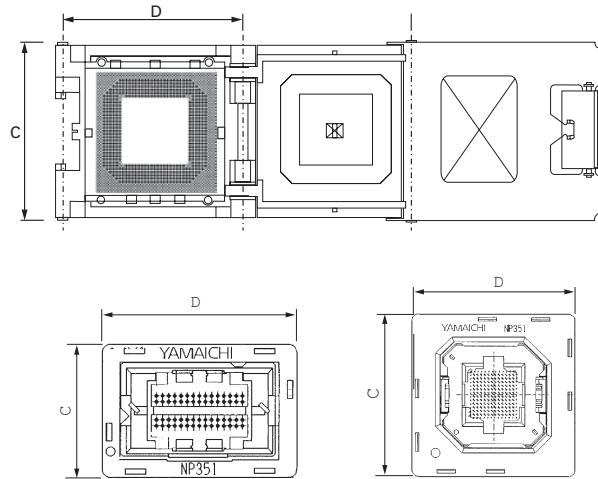

1.00MM PITCH (CONT'D)

Part Number	Pin Count	Grid Size	Package Size A X B	Socket Dimensions C x D	Lid Type
NP483-1924-058	1924	44 x 44	45 x 45	74.0 x 74.0	OT
NP483-1936-060	1936	44 x 44	45 x 45	74.0 x 74.0	OT
NP483-2116-014-1	2116	46 x 46	47.5 x 47.5	74.0 x 74.0	OT
NP483-2209-003	2209	47 x 47	50 x 50	74.0 x 74.0	OT

1.27MM PITCH

Part Number	Pin Count	Grid Size	Package Size A X B	Socket Dimensions C x D	Lid Type
NP276-11904	119	7 x 17	14 x 22	27.0 x 33.2	OT
NP276-11935	119	7 x 17	14 x 22	27.0 x 33.2	OT
NP276-15316.AC-12849	119	7 x 17	14 x 22	28.4 x 33.2	OT
NP276-25626.A106711-001	121	11 x 11	15 x 15	49.4 x 49.4	OT
NP276-15334	153	9 x 17	14 x 22	28.4 x 33.2	OT
NP276-37206 AC-03144	204	17 x 17	23 x 23	49.4 x 49.4	OT
NP276-37206 AC-08329	217	17 x 17	23 x 23	49.4 x 49.4	OT
NP276-37206.A103582-***	233	17 x 17	23 x 23	49.4 x 49.4	OT
NP276-25626-*	256	16 x 16	21 x 21	49.4 x 49.4	OT
NP276-37206.AC-02310	256	20 x 20	27 x 27	49.4 x 49.4	OT
NP276-37206.AC-03145	256	20 x 20	27 x 27	49.4 x 49.4	OT
NP276-37206.AC-03327	256	20 x 20	27 x 27	49.4 x 49.4	OT
NP276-37206.AC-03134	272	20 x 20	27 x 27	49.4 x 49.4	OT
NP276-87318 AC-23775	273	20 x 20	27 x 27	68.0 x 68.0	OT
NP276-37206.A104323-001	277	20 x 20	27 x 27	49.4 x 49.4	DL
NP276-37206.A101288-001	316	20 x 20	27 x 27	49.4 x 49.4	OT
NP276-40009-*.AC-06524	320	20 x 20	27 x 27	49.4 x 49.4	OT
NP276-37206.AC-05610	328	20 x 20	27 x 27	49.4 x 49.4	OT
NP276-52928.AC-12427-*	329	23 x 23	31 x 31	58.4 x 58.4	OT
NP276-40037-*.AC-18666	345	20 x 20	31 x 31	58.4 x 58.4	OT
NP276-37206.A100350-001	352	20 x 20	27 x 27	49.4 x 49.4	OT
NP276-59608.AC-03146	352	26 x 26	35 x 35	58.4 x 58.4	OT
NP276-59608.AC-03328	352	26 x 26	35 x 35	58.4 x 58.4	OT
NP276-59608.AC-04944	352	26 x 26	35 x 35	58.4 x 58.4	OT
NP276-59608.AC-03149	356	26 x 26	35 x 35	58.4 x 58.4	OT
NP276-40009.A104318-001	364	20 x 20	27 x 27	49.4 x 49.4	OT
NP276-37206-*	372	20 x 20	27 x 27	49.4 x 49.4	OT
NP276-52928.AC-12426	385	23 x 23	31 x 31	58.4 x 58.4	OT

**1.27MM PITCH (CONT'D)**

Part Number	Pin Count	Grid Size	Package Size A X B	Socket Dimensions C x D	Lid Type
NP276-59608.AC-02913	388	26 x 26	35 x 35	58.4 x 58.4	OT
NP276-59608.AC-03137	388	26 x 26	35 x 35	58.4 x 58.4	OT
NP276-59608.AC-07411	388	26 x 26	35 x 35	58.4 x 58.4	OT
NP276-40009-*	400	20 x 20	27 x 27	49.4 x 49.4	OT
NP276-40009-A4	400	20 x 20	27 x 27	49.4 x 49.4	OT
NP276-59608 AC-11092	416	26 x 26	35 x 35	58.4 x 58.4	OT
NP276-59608.AC-05955	420	26 x 26	35 x 35	58.4 x 58.4	OT
NP276-59608-1 .AC-09801	420	26 x 26	35 x 35	58.4 x 58.4	OT
NP276-87318.AC-05630	432	31 x 31	40 x 40	58.4 x 58.4	OT
NP276-87318.AC-11938	432	31 x 31	40 x 40	58.4 x 58.4	OT
NP276-59608.AC-04460	456	26 x 26	35 x 35	58.4 x 58.4	OT
NP276-75319.AC-14013	480	29 x 29	37.5 x 37.5	68.0 x 68.0	OT
NP276-59608.AC-03035	484	26 x 26	35 x 35	58.4 x 58.4	OT
NP276-59608-2.AC-23795	484	26 x 26	35 x 35	58.4 x 58.4	OT
NP276-59608.AC-07102	492	26 x 26	35 x 35	58.4 x 58.4	OT
NP276-59608.AC-08313	492	26 x 26	35 x 35	58.4 x 58.4	OT
NP276-75319-*.AC-10439	493	29 x 29	37.5 x 37,5	68.0 x 68.0	OT
NP276-52928-B1	529	23 x 23	31 x 31	58.4 x 58.4	OT
NP276-54036-*	540	32 x 32	42.5 x 42.5	74.0 x 74.0	OT
NP276-96924.AC-08324	560	33 x 33	42.5 x 42.5	74.0 x 74.0	OT
NP276-76820.AC-06128	576	30 x 30	40 x 40	68.0 x 68.0	OT
NP276-76820.AC-08955	576	30 x 30	40 x 40	68.0 x 68.0	OT
NP276-59608-B2	596	26 x 26	35 x 35	58.4 x 58.4	OT
NP276-110522-AC-09796	600	35 x 35	45 x 45	74.0 x 74.0	OT
NP276-87318.AC-12416	600	31 x 31	40 x 40	58.4 x 58.4	OT
NP276-62525-*	625	25 x 25	35 x 35	58.4 x 58.4	OT
NP276-75319.AC-20616	633	29 x 29	37.5 x 37,5	68.0 x 68.0	OT
NP276-110522.AC-15751	650	35 x 35	37.5 x 37.5	74.0 x 74.0	OT
NP276-110522.AC-17392	652	35 x 35	45 x 45	74.0 x 74.0	OT
NP276-110522.AC-17393	652	35 x 35	45 x 45	74.0 x 74.0	OT
NP276-110522.AC-18327	652	35 x 35	45 x 45	74.0 x 74.0	OT
NP276-87318.AC-14002	672	31 x 31	40 x 40	58.4 x 58.4	OT
NP276-67639-P-*	676	26 x 26	35 x 35	68.0 x 68.0	OT
NP276-87318-*	873	31 x 31	40 x 40	58.4 x 58.4	OT
NP276-96924-1	969	33 x 33	42,5 x 42,5	74.0 x 74.0	OT
NP276-110522-*	1105	35 x 35	45 x 45	74.0 x 74.0	OT

All tables show only a selection of sockets available. For customised or other socket types, please contact Yamaichi Electronics

**BASE SOCKETS 27.0 X 38.0**

NP276-11904\*

Max. Grid Size 7 x 17  
Max. Body Size 14 x 22  
Max. Pin Count 119

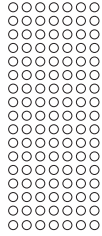
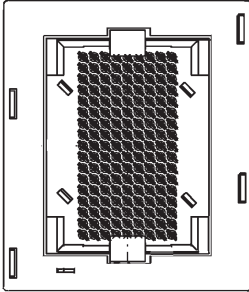

**BASE SOCKETS 26.4 X 33.2**

NP276-11904-3

Max. Grid Size 7 x 17  
Max. Body Size 14 x 22  
Max. Pin Count 119

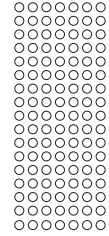
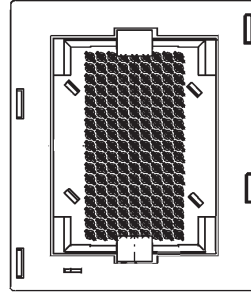

**BASE SOCKET 28.4 X 33.2**

NP276-11935\*

Max. Grid Size 7 x 17  
Max. Body Size 14 x 22  
Max. Pin Count 119

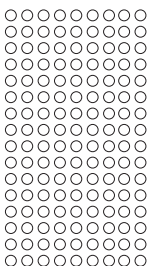
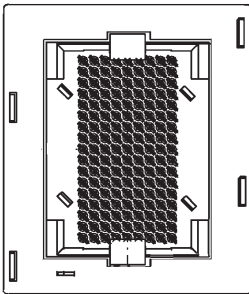

**BASE SOCKET 49.4 X 49.4**

NP276-25626-\*

Max. Grid Size 16 x 16  
Max. Body Size 21 x 21  
Max. Pin Count 256

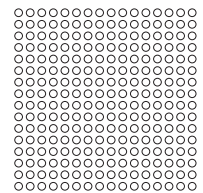
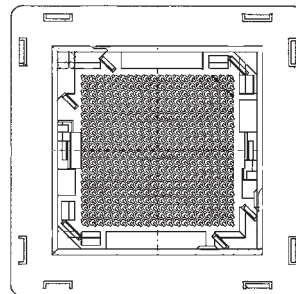

**BASE SOCKET 49.4 X 49.4**

NP276-37206-\*

Max. Grid Size 20 x 20  
Max. Body Size 27 x 27  
Max. Pin Count 372

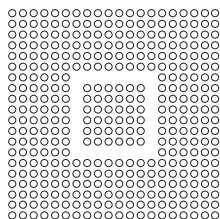
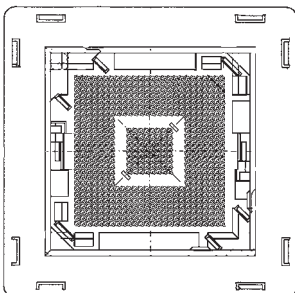

**BASE SOCKET 49.4 X 49.4**

NP276-40009-\*

Max. Grid Size 20 x 20  
Max. Body Size 27 x 27  
Max. Pin Count 400

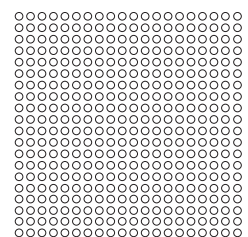
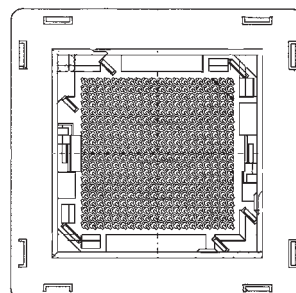



**BASE SOCKET 58.4 X 58.4**

NP276-59608-*	Max. Grid Size	26 x 26
	Max. Body Size	35 x 35
	Max. Pin Count	596

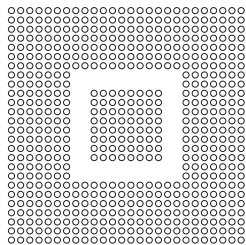
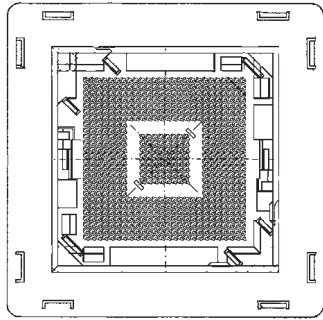

**BASE SOCKET 58.4 X 58.4**

NP276-62525-B*	Max. Grid Size	25 x 25
	Max. Body Size	33 x 33
	Max. Pin Count	625

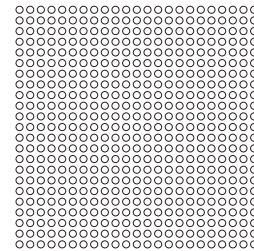
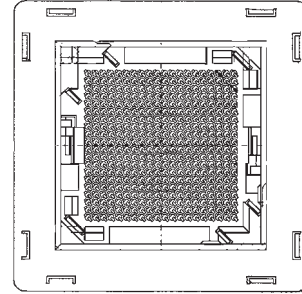

**BASE SOCKET 68.0 X 68.0**

NP276-87318-*	Max. Grid Size	31 x 31
	Max. Body Size	40 x 40
	Max. Pin Count	873

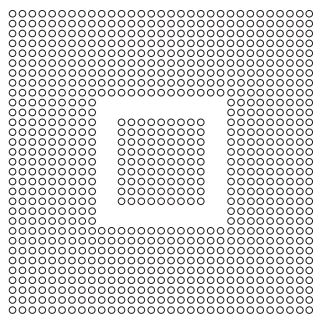
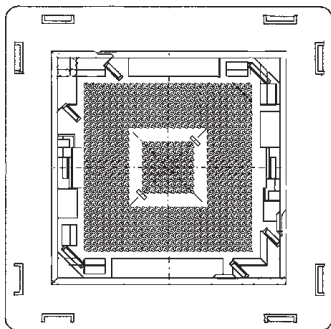

**BASE SOCKET 74.0 X 74.0**

NP276-110522-*	Max. Grid Size	35 x 35
	Max. Body Size	45 x 45
	Max. Pin Count	1105

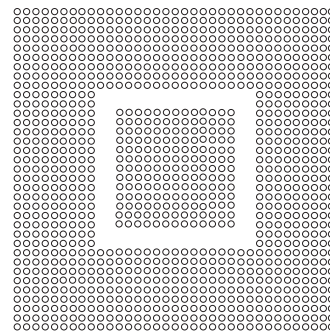
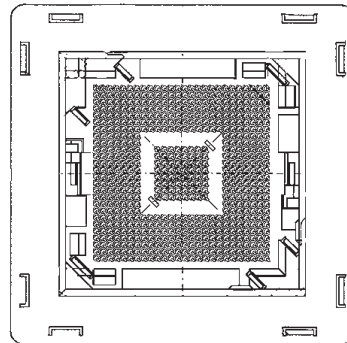

SERIES NP506, NP583, NP404, NP473, NP445, NP364 / IC609, IC610 / QFN11T

**SPECIFICATIONS**

Insulation Resistance: 1,000MΩ min. at 100V DC  
 Withstanding Voltage: 100V AC min. for 1 minute  
 Contact Resistance: 100mΩ or less  
 Operating Temp.Range: -40°C to +150°C

**MATERIALS AND FINISH**

Housing: Polyetherimide (PEI), glass-filled  
 Polyethersulphone (PES), glass-filled  
 Contacts: Beryllium Copper (BeCu)  
 Plating: Gold over Nickel

**SERIES NP506 AND NP583 (OPEN TOP - TH)**

**SPECIFICATIONS / MATERIAL AND FINISH**  
 (see above)

**FEATURES**

- Active alignment for IC package positioning
- NP583 is suitable for to contact with "dimples"
- Suitable for package outline size in the range 4÷8 sqmm
- Suitable for package thickness in the range 0.70 ÷ 1.30 mm
- Selectable cover outline size (25 sqmm & 27 sqmm)
- Twin beam contacts
- 4 latches package warping manage
- GND Pin optional
- Operation Force: 2.5 kgf MAX (cover stroke 3.50 mm)



**SERIES NP404 (OPEN TOP - TH)**

**SPECIFICATIONS / MATERIAL AND FINISH**  
 (see above)

**FEATURES**

- Buckling Beam contacts



**SERIES NP473 AND NP364 (OPEN TOP - TH)**

**SPECIFICATIONS / MATERIAL AND FINISH**  
 (see above)

**FEATURES**

- 0.50 and 1.00mm pitch
- Package outline size in the range 4~8 sqmm (only even number of pins)
- Buckling and Twin Beam contacts
- Low actuation force
- Centre Contact Pins available for exposed pad (up to 180°C)

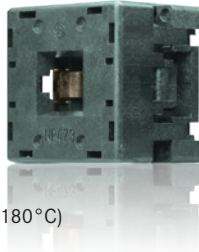

**SERIES NP445 (OPEN TOP - TH)**

**SPECIFICATIONS / MATERIAL AND FINISH**  
 (see above)

**FEATURES**

- 0.50mm pitch
- Centre Contact available for exposed pads



**SERIES IC609 AND IC610 (CLAMSHELL - TH)**

**SPECIFICATIONS / MATERIAL AND FINISH**  
 (see above)

**FEATURES**

- 0.40 and 0.50mm pitch
- Centre Contact available for exposed pads, heat sink and floating base non sticking option
- Accommodates 0.5 ~ 1.2mm thick package



**SERIES QFN11T (CLAMSHELL - TH)**

**SPECIFICATIONS / MATERIAL AND FINISH**  
 (see above)

**FEATURES**

- Centre Contact available for exposed pads
- Probe Pins
- Heat sink



QFN ePAD WITH 4-SIGNAL AND THERMAL PINS FOR 180°C

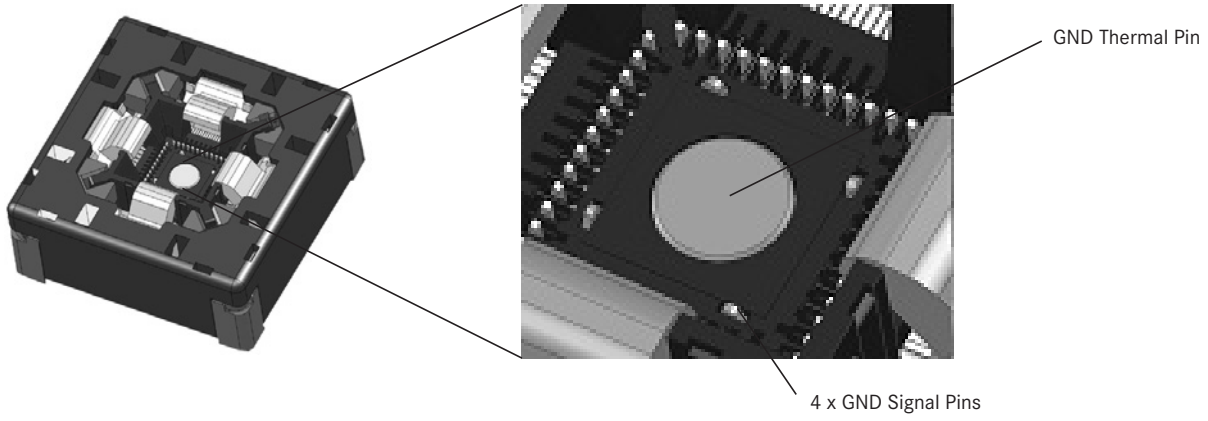

TYPICAL (NP506) OPEN TOP SOCKET DIMENSIONS

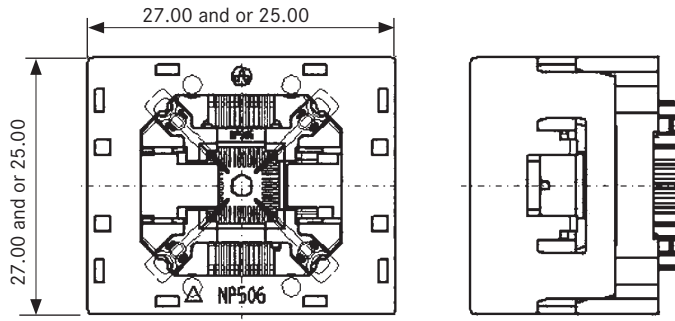

QFN package with pad leads

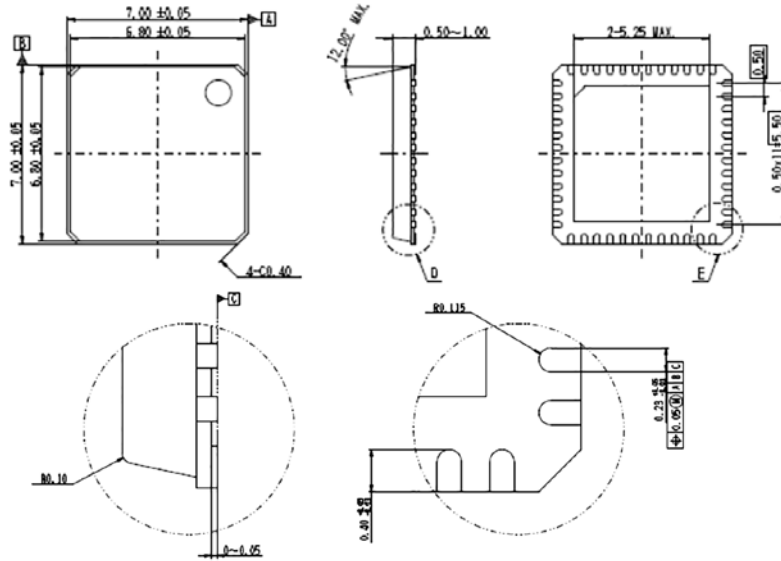

TYPICAL (NP583) OPEN TOP SOCKET DIMENSIONS

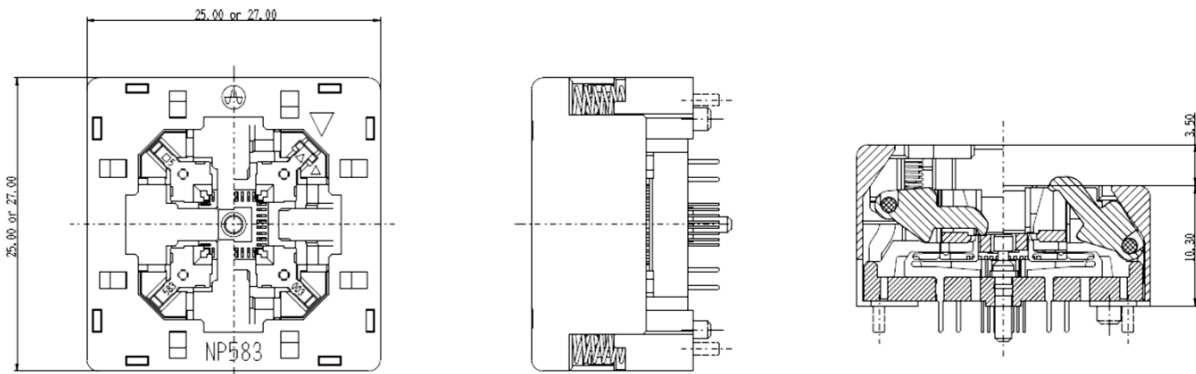

QFN package with "dimple" pad leads

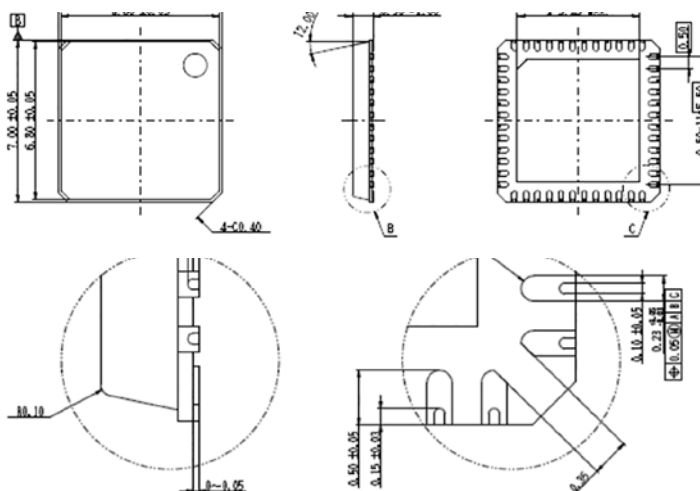

TYPICAL CLAMSHELL SOCKET DIMENSIONS

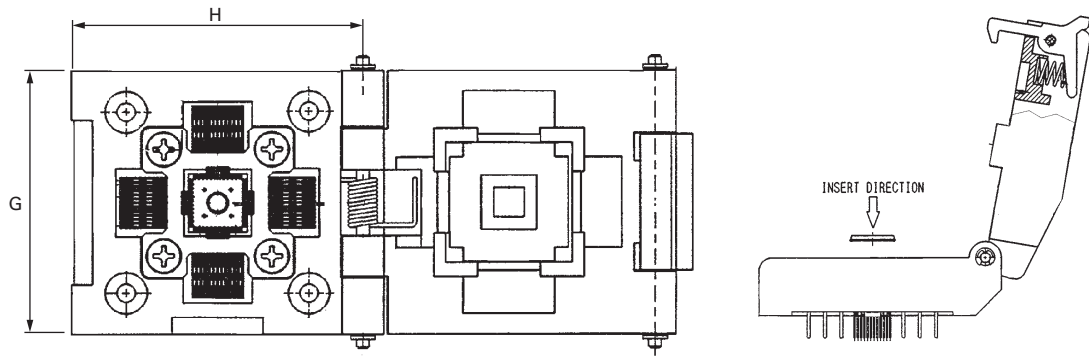

TYPICAL OUTLINE DIMENSIONS OPEN TOP SOCKET

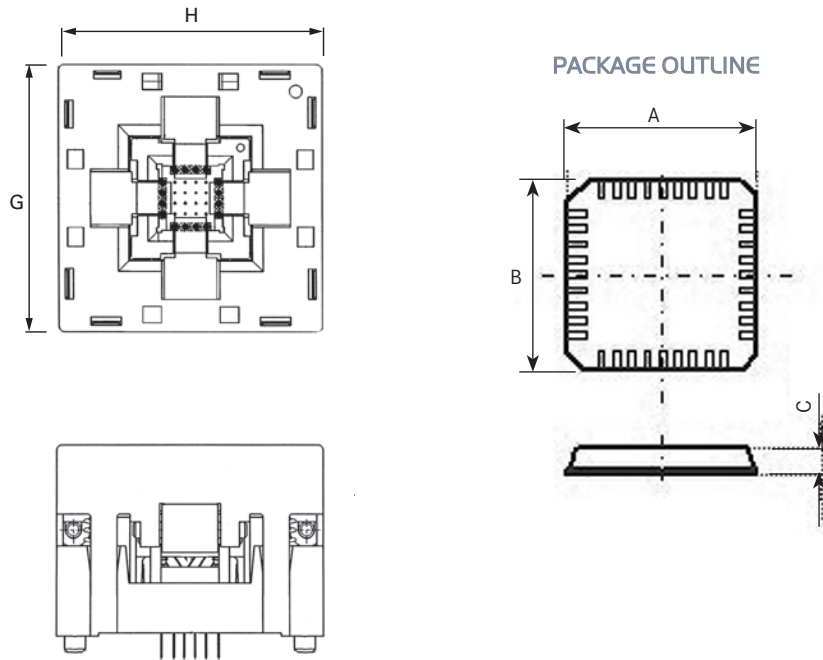

0.40MM PITCH

Part Number	Pin Count	IC Body Dim. A x B	IC Body Dim. C (Ht.)	Center pin	Socket Dim. G X H	Pins (each side)	Package Type
IC549-0204-005	20	3 x 3	0.5 - 1.2	No	24.5 x 22.0	5 x 5	LID
IC549-0204-005-G	20	3 x 3	0.5 - 1.2	1	24.5 x 22.0	5 x 5	LID
IC549-0284-003	28	4 x 4	0.5 - 1.2	No	24.5 x 22.0	6 x 6	LID
IC549-0284-003-G	28	4 x 4	0.5 - 1.2	1	24.5 x 22.0	6 x 6	LID
NP506-028-046-SCG	28	4 x 4	0.75	1	25.0 x 25.0	7 x 7	OT
IC549-0324-006	32	4 x 4	0.5 - 1.2	No	24.5 x 22.0	8 x 8	LID
IC549-0324-006-G	32	4 x 4	0.5 - 1.2	1	24.5 x 22.0	8 x 8	LID
NP506-032-039-SCG	32	4 x 4	0.85	1	25.0 x 25.0	8 x 8	OT
NP506-036-049-SCG	36	5 x 5	0.85	1	25.0 x 25.0	9 x 9	OT
IC549-0364-011	36	5 x 5	0.5 - 1.2	No	24.05 x 22.0	9 x 9	LID
IC549-0364-011-G	36	5 x 5	0.5 - 1.2	1	24.05 x 22.0	9 x 9	LID
NP583-040-016-x	40	5 x 5	0.85	1 (flat)	25.0 x 25.0	10 x 10	OT
IC549-0404-004	40	5 x 5	0.5 - 1.2	No	24.5 x 22.0	10 x 10	LID
IC549-0404-004-G	40	5 x 5	0.5 - 1.2	1	24.5 x 22.0	10 x 10	LID
NP506-040-007	40	5 x 5	0.90	1	32.1 x 26.7	10 x 10	OT
NP506-040-048-SCG	40	5 x 5	0.75	1	25.0 x 25.0	10 x 10	OT
IC549-0444-015	44	6 x 6	0.5 - 1.2	No	24.5 x 22.0	11 x 11	LID
IC549-0444-015-G	44	6 x 6	0.5 - 1.2	1	24.5 x 22.0	11 x 11	LID
IC549-0484-010	48	6 x 6	0.5 - 1.2	No	24.5 x 22.0	12 x 12	LID
IC549-0484-010-G	48	6 x 6	0.5 - 1.2	1	24.5 x 22.0	12 x 12	LID
NP506-048-002-SG	48	6 x 6	0.90	1	32.1 x 26.7	12 x 12	OT
NP506-048-044-SCG	48	7 x 7	0.75	1	25.0 x 25.0	12 x 12	OT
NP506-052-052-SCG	52	7 x 7	0.75	1	25.0 x 25.0	13 x 13	OT

cont'd next page

**0.40MM PITCH (CONT'D)**

Part Number	Pin Count	IC Body Dim. A x B	IC Body Dim. C (Ht.)	Center pin	Socket Dim. G X H	Pins (each side)	Package Type
IC549-0564-017	56	7 x 7	0.5 -1.2	No	24.5 x 22	14 x 14	LID
IC549-0564-017-G	56	7 x 7	0.5 -1.2	1	24.5 x 22	14 x 14	LID
NP506-056-006-SG	56	7 x 7	0.90	1	32.1 x 26.7	14 x 14	OT
NP506-056-009-SG	56	7 x 7	0.85	1	32.1 x 26.7	14 x 14	OT
NP506-056-051-SCG	56	7 x 7	0.75	1	25 x 25	17 x 17	OT
IC549-0644-008	64	8 x 8	0.5 -1.2	No	24.5 x 22	16 x 16	LID
IC549-0644-008-G	64	8 x 8	0.5 -1.2	1	24.5 x 22	16 x 16	LID
NP506-064-038-S	64	8 x 8	0.75	No	36 x 31	16 x 16	OT
NP506-064-038-SG	64	8 x 8	0.75	1	36 x 31	16 x 16	OT
QFN11T064-005	64	8 x 8	0.90	1+2	35 x 32	16 x 16	LID
QFN11T064-005-H	64	8 x 8	0.90	1	35. x 32.	16 x 16	LID
QFN11T064-005-G	64	8 x 8	0.90	2	35. x 32.	16 x 16	LID
QFN11T064-005-N	64	8 x 8	0.90	No	35.0x 32.	16 x 16	LID
NP506-068-041-SCG	68	8 x 8	0.75	1	25 x 25	17 x 17	OT
NP506-068-020-S	68	8 x 8	0.90	No	36 x 31	17 x 17	OT
NP506-068-020-SG	68	8 x 8	0.90	1	36 x 31	17 x 17	OT
QFN11T068-002	68	8 x 8	0.90	1+2	35 x 32	17 x 17	LID
QFN11T068-002.A108429-001	68	8 x 8	0.90	No	35 x 32	17 x 17	LID
IC549-0764-012	76	9 x 9	0.5 -1.2	No	24.5 x 22	19 x 19	LID
IC549-0764-012-G	76	9 x 9	0.5 -1.2	1	24.5 x 22	19 x 19	LID
QFN11T076-001	76	9 x 9	0.90	1+2	35 x 32	19 x 19	LID
IC549-0804-013	80	9 x 9	0.5 -1.2	No	24.5 x 22	20 x 20	LID
IC549-0804-013-G	80	9 x 9	0.5 -1.2	1	24.5 x 22	20 x 20	LID
QFN11T080-001	80	9 x 9	0.70~1.00	1+2	35. x 32.	20 x 20	LID
QFN11T084-002	84	10 x 10	0.90	1+2	35.0 x 32.0	21 x 21	LID
NP506-088-014	88	10 x 10	0.85	1	36 x 31	22 x 22	OT
NP506-088-047-SG	88	10 x 10	0.85	1	36 x 31	22 x 22	OT
QFN11T088-001	88	10 x 10	0.90	2+1	35 x 32	22 x 22	LID
IC549-1004-014	100	12 x 12	0.5 -1.2	No	24.5 x 22	25 x 25	LID
IC549-1004-014-G	100	12 x 12	0.5 -1.2	1	24.5 x 22	25 x 25	LID
IC549-1084-004	108	12 x 12	0.5 -1.2	No	24.5 x 22	27 x 27	LID
IC549-1084-007-G	108	12 x 12	0.5 -1.2	1	24.5 x 22	27 x 27	LID

**0.50MM PITCH**

Part Number	Pin Count	IC Body Dim. A x B	IC Body Dim. C (Ht.)	Center pin	Socket Dim. G X H	Pins (each side)	Package Type
IC550-0124-003	12	3 x 3	0.5 - 1.2	No	24.5 x 22	3 x 3	LID
IC550-0124-003-G	12	3 x 3	0.5 - 1.2	1	24.5 x 22	3 x 3	LID
IC550-0164-005	16	3 x 3	0.5 - 1.2	No	24.5 x 22	4 x 4	LID
IC550-0164-005-G	16	3 x 3	0.5 - 1.2	1	24.5 x 22	4 x 4	LID
NP404-016-019-1	16	4 x 5	0.90	4	32 x 32	4 x 4	OT
NP404-01613-*	16	3 x 3	0.5 - 1.2	No	32 x 32	4 x 4	OT
NP404-01613-1 A108715-001	16	3 x 3	0.75	4	32 x 32	4 x 4	OT
IC550-0164-024	16	4 x 4	0.5 - 1.2	NO	24.5 x 22	4 x 4	LID
IC550-0164-024G	16	4 x 4	0.5 - 1.2	1	24.5 x 22	4 x 4	LID
IC550-0204-008	20	3 x 3	0.5 - 1.2	No	24.5 x 22	5 x 5	LID
IC550-0204-008-G	20	3 x 3	0.5 - 1.2	1	24.5 x 22	5 x 5	LID
IC550-0204-009-G	20	4 x 4	0.5 - 1.2	1	24.5 x 22	5 x 5	LID
NP473-020-004-1	20	4 x 4	0.5 - 1.2	No	25 x 25	5 x 5	OT
NP506-020-035	20	4 x 4	0.75	No	25 x 25	5 x 5	OT
NP506-020-035-CG	20	4 x 4	0.75	1	25 x 25	5 x 5	OT
IC550-0244-015	24	4 x 4	0.5 - 1.2	No	24.5 x 22	6 x 6	LID
NP583-024-004-x	24	4 x 4	0.5 - 1.0	No	25 x 25	6 x 6	OT
NP583-024-014-x	24	4 x 4	0.5 - 1.0	1 (crown)	25 x 25	6 x 6	OT
IC550-0244-015-G	24	4 x 4	0.5 - 1.2	1	24.5 x 22	6 x 6	LID
NP404-02412-*	24	4 x 4	0.75	No	32 x 32	6 x 6	OT
NP404-02412-1 A107658-001	24	4 x 4	0.75	4	32 x 32	6 x 6	OT
NP506-024-032-C	24	4 x 4	0.75	No	25 x 25	6 x 6	OT
NP506-024-032-CG	24	4 x 4	0.75	1	25 x 25	6 x 6	OT
QFN11T024-002	24	3.5 x 4.5	0.95	No	32 x 29	4 x 8	LID

 cont'd next page 

Outline IC Body Dimensions

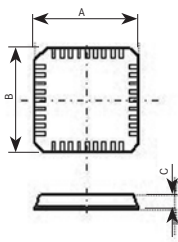

Outline Open Top Socket Dimensions

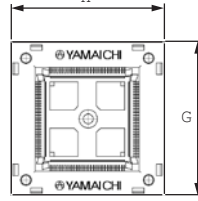

Outline Clamshell Socket Dimensions

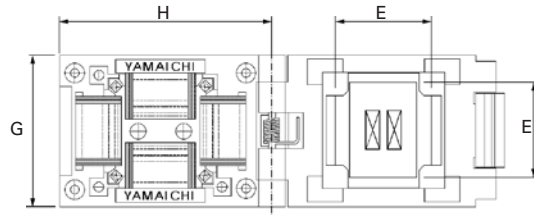
**0.50MM PITCH (CONT'D)**

Part Number	Pin Count	IC Body Dim. A x B	IC Body Dim. C (Ht.)	Center pin	Socket Dim. G X H	Pins (each side)	Package Type
NP583-028-013-x	28	5 x 5	0.85	1 (flat)	25 x 25	7 x 7	OT
IC550-0284-011	28	5 x 5	0.5 - 1.2	NO	24.5 x 22	7 x 7	LID
IC550-0284-011-G	28	5 x 5	0.5 - 1.2	1	24.5 x 22	7 x 7	LID
NP404-028-021-1	28	4 x 5	1.00	4	32 x 32	6 x 8	OT
NP506-028-028	28	5 x 5	0.90	No	25 x 32	7 x 7	OT
NP506-028-028-CG	28	5 x 5	0.90	1	25 x 25	7 x 7	OT
NP583-032-003-x	32	5 x 5	0.5 - 1.0	No	25 x 25	8 x 8	OT
NP583-032-015-x	32	5 x 5	0.85	1 (crown)	25 x 25	8 x 8	OT
NP583-032-020-x	32	5 x 5	0.85	1 (flat)	25 x 25	8 x 8	OT
IC550-0324-007	32	5 x 5	0.5 - 1.2	No	24.5 x 22	8 x 8	LID
IC550-0324-022	32	5 x 5	0.5 - 1.2	No	24.5 x 22	8 x 8	LID
IC550-0324-022-G	32	5 x 5	0.5 - 1.2	1	24.5 x 22	8 x 8	LID
IC550-0324-007-G	32	5 x 5	0.5 - 1.2	1	24.5 x 22	8 x 8	LID
NP445-032-004	32	5 x 5	0.85	2	32.8 x 32.8	8 x 8	OT
NP473-032-006-*	32	5.1 x 6.2	0.90	No	32 x 32	7 x 9	OT
NP506-032-013-G	32	5 x 5	0.31 - 0.6	1	32.1 x 26.7	8 x 8	OT
NP506-032-031-C	32	5 x 5	0.75	No	25 x 25	8 x 8	OT
NP506-032-031-CG	32	5 x 5	0.75	1	25 x 25	8 x 8	OT
QFN11T032-004	32	4.50 x 4.50	0.85	No	32 x 29	10 x 6	LID
QFN11T032-008	32	5 x 5	0.85	1	32 x 29	8 x 8	LID
IC550-0364-016	36	6 x 6	0.5 - 1.2	NO	24.5 x 22	9 x 9	LID
IC550-0364-016-G	36	6 x 6	0.5 - 1.2	1	24.5 x 22	9 x 9	LID
IC550-0364-016	36	6 x 6	0.5 - 1.2	NO	24.5 x 22	4 x 4	LID
IC550-0364-016-G	36	6 x 6	0.5 - 1.2	1	24.5 x 22	4 x 4	LID
NP473-036-007-*	36	6 x 6	0.85	No	25 x 25	9 x 9	OT
NP506-036-034-C	36	6 x 6	0.85	No	25 x 25	9 x 9	OT
NP506-036-034-CG	36	6 x 6	0.85	1	25 x 25	9 x 9	OT
IC550-0364-016	36	6 x 6	0.5 - 1.2	No	24.5 x 22	9 x 9	LID
IC550-0364-016-G	36	6 x 6	0.5 - 1.2	1	24.5 x 22	9 x 9	LID
NP506-040-016-SG	40	5 x 5	0.90	1	32.1 x 26.7	10 x 10	OT
IC550-0404-012	40	6 x 6	0.5 - 1.2	No	24.5 x 22	10 x 10	LID
IC550-0404-012-G	40	6 x 6	0.5 - 1.2	1	24.5 x 22	10 x 10	LID
IC550-0404-019	40	6 x 6	0.5 - 1.2	No	24.5 x 22	10 x 10	LID
IC550-0404-019-G	40	6 x 6	0.5 - 1.2	1	24.5 x 22	10 x 10	LID
NP404-04016-*	40	6 x 6	0.5 - 1.2	16	32 x 32	10 x 10	OT
NP583-040-010-x	40	7 x 7	0.5 - 1.0	1 (crown)	25 x 25	10 x 10	OT
NP506-040-030-C	40	6 x 6	0.75	No	25 x 25	10 x 10	OT
NP506-040-030-CG	40	6 x 6	0.75	1	25 x 25	10 x 10	OT
QFN11T040-004	40	6 x 6	0.65	1	32 x 29	10 x 10	LID
QFN11T040-005	40	5.50 x 6.50	0.85	No	35 x 32	10 x 10	LID
QFN11T040-006.A103327-001	40	6 x 6	0.85	No	32.0 x 29.0	8 x 8	LID
QFN11T044-004	44	7x7	0.80	1	32 x 29	12 x 8	LID
NP473-044-001-1	44	7 x 7	0.5 - 1.2	No	25 x 25	11 x 11	LID
NP506-044-050-SCG	44	6 x 6	0.75	1	25 x 25	11 x 11	OT
NP506-044-036-C	44	7 x 7	0.75	No	25 x 25	11 x 11	OT
NP506-044-036-CG	44	7 x 7	0.75	1	25 x 25	11 x 11	OT
IC550-0484-004	48	7 x 7	0.5 - 1.2	No	24.5 x 22	12 x 12	LID
IC550-0484-004-G	48	7 x 7	0.5 - 1.2	1	24.5 x 22	12 x 12	LID
NP445-048-001	48	7 x 7	0.85	6	32.8 x 32.8	12 x 12	OT
NP583-048-005-x	48	7 x 7	0.5 - 1.0	No	25 x 25	12 x 12	OT
NP583-048-006-x	48	7 x 7	0.5 - 1.0	1 (flat)	25 x 25	12 x 12	OT

cont'd next page

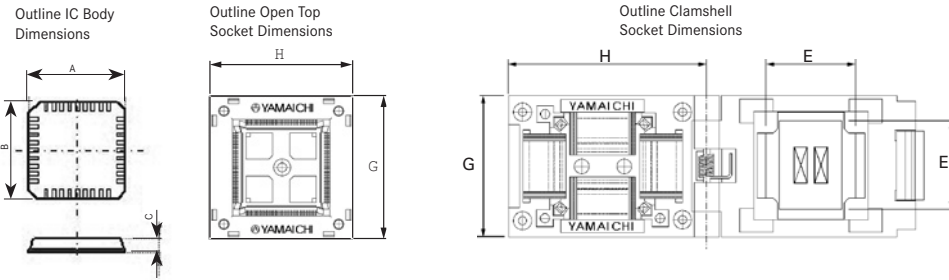
**0.50MM PITCH (CONT'D)**

Part Number	Pin Count	IC Body Dim. A x B	IC Body Dim. C (Ht.)	Center pin	Socket Dim. G X H	Pins (each side)	Package Type
NP583-048-007-x	48	7 x 7	0.5 - 1.0	1 (crown)	25 x 25	12 x 12	OT
NP445-048-004	48	7 x 7	0.50	6	32.8 x 32.8	12 x 12	OT
NP506-048-001-G	48	7.2 x 7.2	0.92	1	32.1 x 26.7	12 x 12	OT
NP506-048-001	48	7.2 x 7.2	0.92	No	32.1 x 26.7	12 x 12	OT
NP506-048-008-G	48	7 x 7	0.90	1	32.1 x 26.7	12 x 12	OT
NP506-048-012-G	48	7 x 7	0.75	1	32.1 x 26.7	12 x 12	OT
NP506-048-015-G	48	7 x 7	0.90	1	32.1 x 26.7	12 x 12	OT
NP506-048-017-C	48	7 x 7	0.75	No	25 x 25	12 x 12	OT
NP506-048-017-CG	48	7 x 7	0.75	1	25.0 x 25	12 x 12	OT
IC550-0524-020	52	8 x 8	0.5 - 1.2	No	24.5 x 22	13 x 13	LID
IC550-0524-020-G	52	8 x 8	0.5 - 1.2	1	24.5 x 22	13 x 13	LID
NP506-052-037-C	52	8 x 8	0.75	No	25 x 25	13 x 13	OT
NP506-052-037-CG	52	8 x 8	0.75	1	25 x 25	13 x 13	OT
IC550-0564-010	56	8 x 8	0.5 - 1.2	No	24.5 x 22	14 x 14	LID
IC550-0564-010-G	56	8 x 8	0.5 - 1.2	1	24.5 x 22	14 x 14	LID
NP404-05610*	56	8 x 8	0.5 - 1.2	No	32 x 32	14 x 14	OT
NP583-056-018-x	56	8 x 8	0.85	1 (crown)	25 x 25	14 x 14	OT
NP404-05610-1 A104902-001	56	8 x 8	0.5 - 1.2	8	32 x 32	14 x 14	OT
NP445-056-005	56	8 x 8	0.85	6	32.8 x 32.8	14 x 14	OT
NP506-056-027-C	56	8 x 8	0.75	No	25 x 25	14 x 14	OT
NP506-056-027-CG	56	8 x 8	0.75	1	25 x 25	14 x 14	OT
QFN11T064-006	64	9 x 9	0.90	1+8	35 x 32	16 x 16	LID
QFN11T064-006-H	64	9 x 9	0.90	1	35 x 32	16 x 16	LID
QFN11T064-006-G	64	9 x 9	0.90	8	35 x 32	16 x 16	LID
QFN11T064-006-N	64	9 x 9	0.90	No	35 x 32	16 x 16	LID
IC550-0644-006	64	9 x 9	0.5 - 1.2	No	24.5 x 22	16 x 16	LID
IC550-0644-006-G	64	9 x 9	0.5 - 1.2	1	24.5 x 22	16 x 16	LID
NP445-064-002	64	9 x 9	0.85	6	32.8 x 32.8	16 x 16	OT
NP445-064-007	64	9 x 9	1.00	4	32.8 x 32.8	16 x 16	OT
QFN11T068-003	68	10 x 10	0.90	1+8	35 x 32	17 x 17	LID
IC550-0684-021	68	10 x 10	0.5 - 1.2	No	24.5 x 22	17 x 17	LID
IC550-0684-021-G	68	10 x 10	0.5 - 1.2	1	24.5 x 22	17 x 17	LID
IC550-0724-018	72	10 x 10	0.5 - 1.2	No	24.5 x 22	18 x 18	LID
IC550-0724-018-G	72	10 x 10	0.5 - 1.2	1	24.5 x 22	18 x 18	LID
NP404-07215*	72	10 x 10	0.85	No	32 x 32	18 x 18	OT
NP404-07215-1 A107620-001	72	10 x 10	0.85	16	32 x 32	18 x 18	OT
QFN11T072-001	72	10 x 10	0.90	1+8	35 x 32	18 x 18	LID
IC550-0804-014	80	12 x 12	0.5 - 1.2	No	24.5 x 22	20 x 20	LID
IC550-0804-014-G	80	12 x 12	0.5 - 1.2	1	24.5 x 22	20 x 20	LID
IC550-0884-013	88	12 x 12	0.5 - 1.2	No	24.5 x 22	22 x 22	LID
IC550-0884-013-G	88	12 x 12	0.5 - 1.2	1	24.5 x 22	22 x 22	LID

**0.65MM PITCH**

QFN11T032-005	32	7 x 7	0.85	No	37.5 x 37.5	8 x 8	LID
---------------	----	-------	------	----	-------------	-------	-----

**0.80MM PITCH**

NP583-016-009	16	4 x 4	1.10 - 2.00	No	25 x 25	4 x 4	OT
NP583-016-009-G	16	4 x 4	1.10 - 2.00	1	25 x 25	4 x 4	OT
NP506-032-067-C	32	8 x 8	2.20 max	No	25 x 25	8 x 8	OT
NP506-032-067-CG	32	8 x 8	2.20 max	1	25 x 25	8 x 8	OT
QFN11T032-007	32	10 x 12	1.50 max	No	32 x 35	10x 6	LID



A universal concept able to accommodate different package types, size, pitch & thickness with minimal change  
 A solution able to minimize the development costs and to shorten the lead time due to a "high mix low volume" product. A solution able to support both burn-in & validation test.

**Custom sockets are also available for products below**

**SERIES IC561 (CLAMSHELL - CMT)**

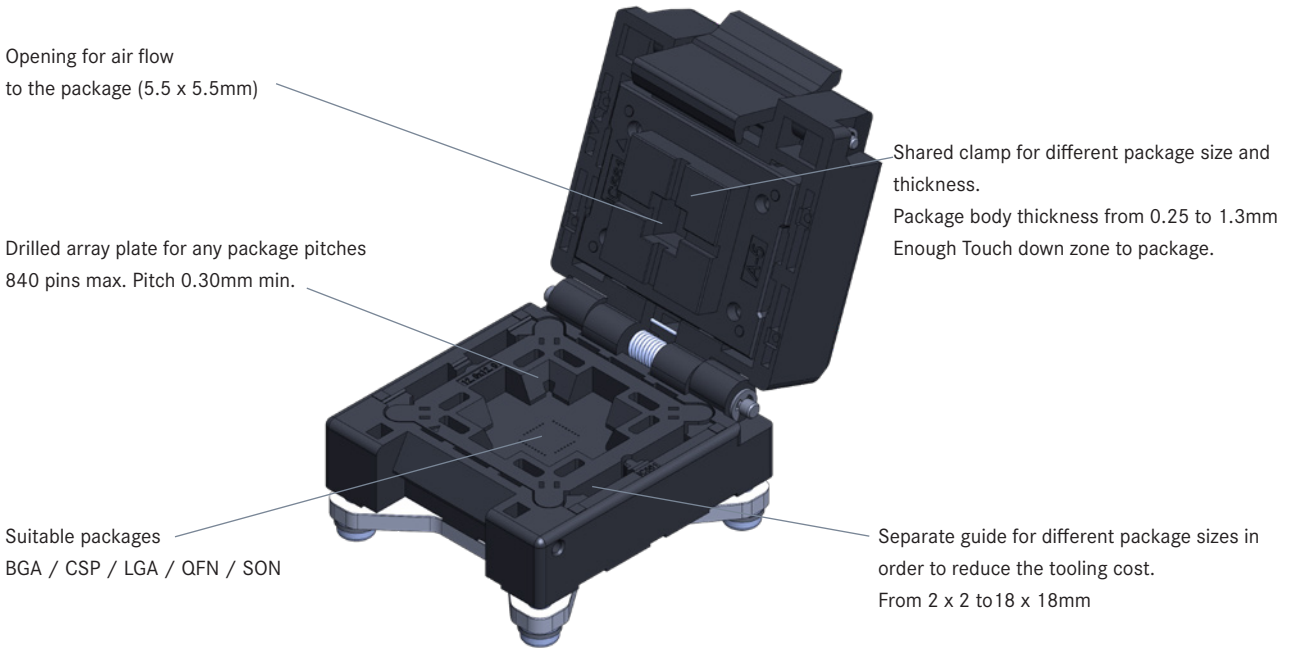

**PITCH CAPABILITY**

- Pitch capability: 0.30mm min. (IC561 / IC564 / NP584)
- Package size capability: 2.0 ~ 10.0 mm  
2.00 20.0 (NP584)
- Package thickness capability : 0.25 ~ 1.3 mm

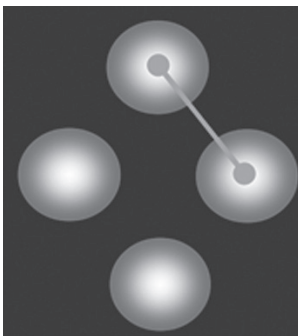

Staggered Pitch

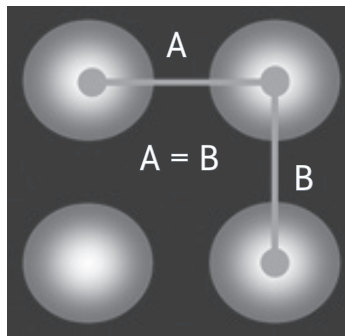

Regular Pitch

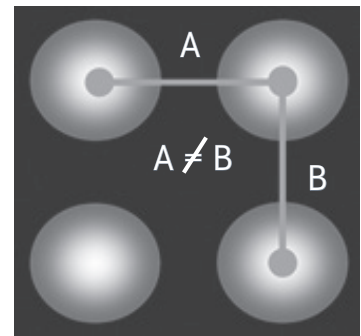

Irregular Pitch

SERIES IC561, IC564 AND NP584

SPECIFICATIONS

Insulation Resistance: 1,000MΩ or more at 100V DC  
 Contact Force: From ~0.101N (10.3gf) to ~ 0.226N (23gf) / pin (IC564 / NP584)  
 Operating Temp.Range: -40°C to +150°C  
 Mating Cycles: 10,000 insertions min.

MATERIALS AND FINISH

Housing: Polyester (PES), glass-filled  
 Polyetherimide (PEI), glass-filled  
 Contacts: Beryllium Copper (BeCu)  
 Plating: Gold over Nickel

FEATURES

- Semi custom socket suitable for BGA, CSP, QFN, SON, LGA packages
- Dimensions from 2x2 to 20x20 mm sq.
- Pitch from 0.30mm to 1.30mm standard, staggered or irregular
- Spring loader pusher
- Airflow through top duct channel
- One outline for all packages
- Compression mount for quick installation and maintenance
- Full flexibility through drilled insulator and milled pusher
- Low cost with respect to a full custom solution

PART NUMBER (EXAMPLES)

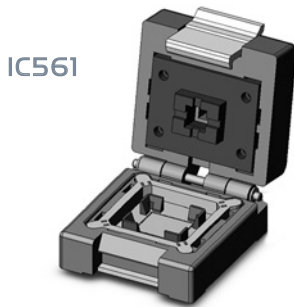
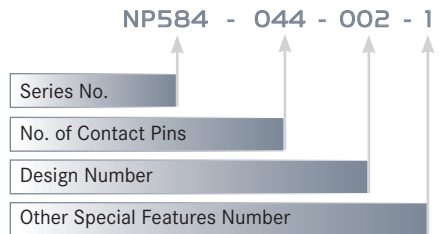
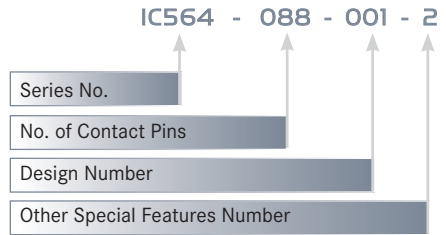
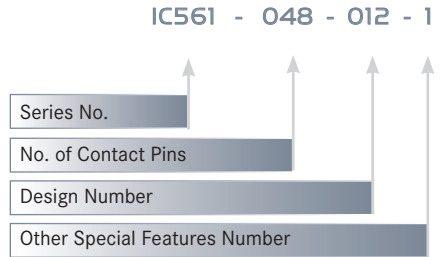

open



close

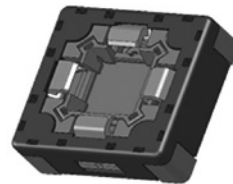

actuated

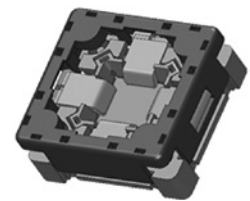

not actuated (DUT)

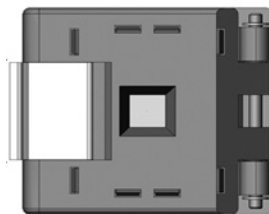

Body size 38.0 x 35.0



Body size 20.5 x 28.8

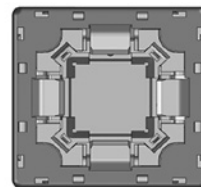

Body size 28.0 x 28.0 / 46.0 x 46.0 (LS)

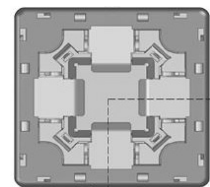

**SPECIFICATIONS**

Insulation Resistance: >1,000MΩ or more at 100V DC  
 Dielectric Withstanding Voltage: 100 V DC for 1 minute  
 Contact Resistance: < 200mΩ at less than 20mV  
 Operating Temp.Range: -40°C to +150°C  
 Contact Force: ~0.157N (16.0gf) / pin  
 Mating Cycles: 20,000 insertions min.

**MATERIALS AND FINISH**

Housing: Polyester (PES), glass-filled  
 Polyetherimide (PEI), glass-filled  
 Contacts: Beryllium Copper (BeCu)  
 Plating: Gold over Nickel

**FEATURES**

- Semi custom socket suitable for large BGA, LGA packages
- PKG Dimensions from 18x18 to 33x33 mm SQ.
- MAX grid 40x40 (1,600 pins)
- Pitch from 0.65 to 1.30 mm standard, staggered or irregular
- Two spring probe pin types: SWP for standard and SUS for high temp.
- Modular design allows easy replacement of socket components in the field
- Individual Contact Pins/ Contact Pin Module/ Heat Sink/ Heater/ Temp Sensor
- Unique cam activated lid mechanism
- Airflow through top duct channel or opening
- Spring Probes for higher electrical // mechanical performance: stable CRes, high Current Carrying Capacity, Low Inductance
- Dual Lid Design/ Low Actuation Force/ 2 Step Vertical Actuation Motion, for bare die and lidded DUT
- Compression mount for quick installation and maintenance

**PART NUMBER (EXAMPLES)**

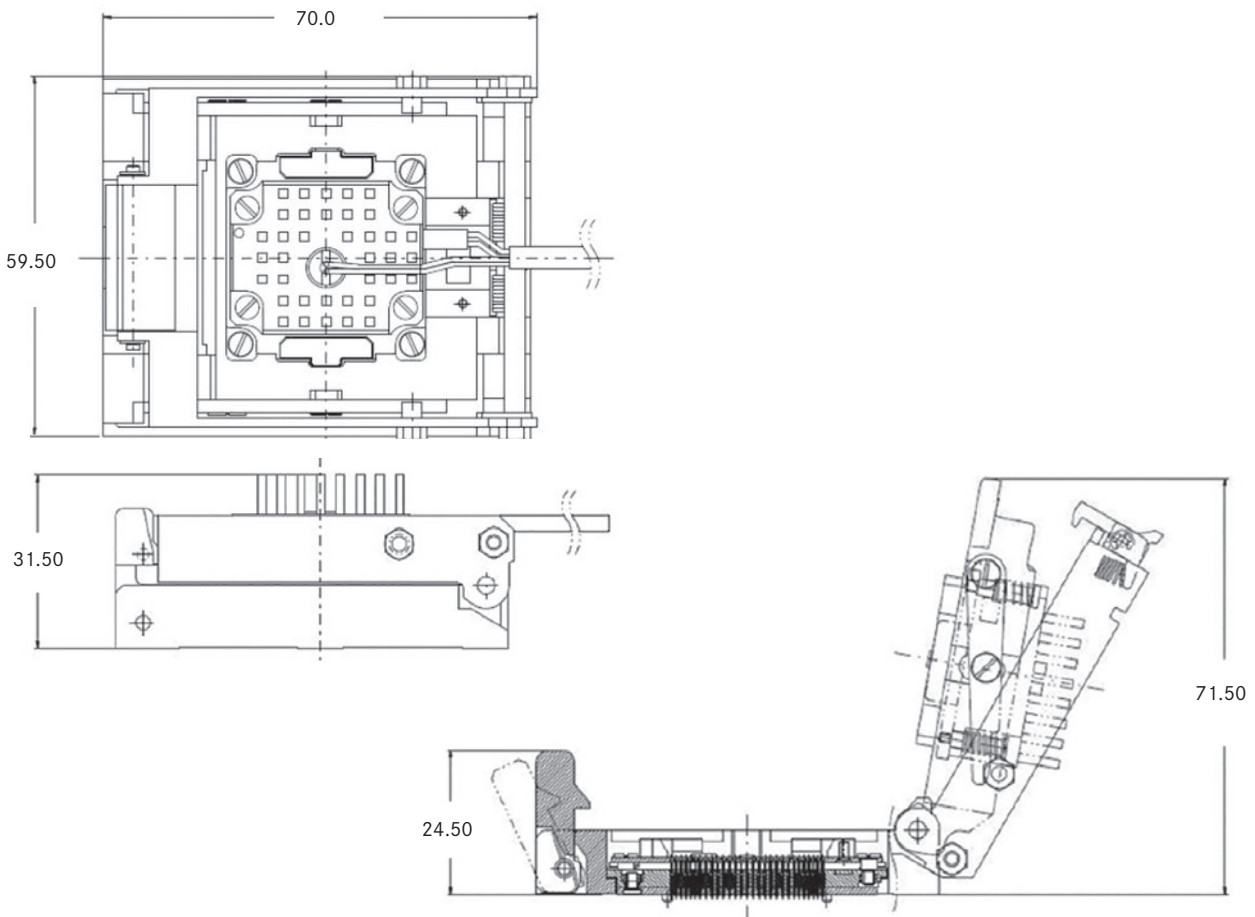
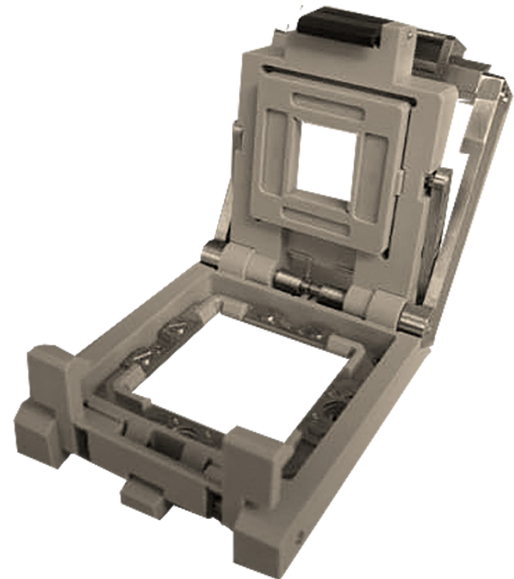
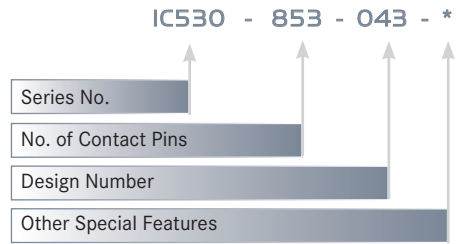

**SPECIFICATIONS**

Insulation Resistance:	>1,000MΩ or more at 100V DC
Dielectric Withstanding Voltage:	100 V DC for 1 minute
Contact Resistance:	< 200mΩ at 20mV
Operating Temp.Range:	-40°C to +150°C
Contact Force:	~0.175N (17.4gf) / pin
Mating Cycles:	10,000 insertions min.

**PART NUMBER (EXAMPLES)**

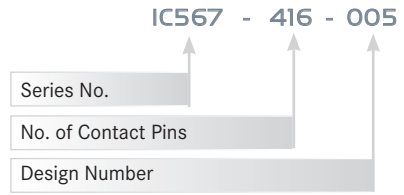

**MATERIALS AND FINISH**

Housing:	Polyester (PES), glass-filled Polyetherimide (PEI), glass-filled
Contacts:	Beryllium Copper (BeCu)
Plating:	Gold over Nickel

**FEATURES**

- Semi custom socket suitable for large BGA, LGA packages
- Pitch from 0.65 / 0.80 / 1.00mm standard
- Dimensions from 2x2 to 37.5x37.5 mm sq.
- PKG Dimensions 20x20 mm SQ. (0.65 mm pitch), max. grid 29x29 (841 pins)
- PKG Dimensions 32x32 mm SQ. (0.80 mm pitch), max. grid 39x39 (1,521 pins)
- PKG Dimensions 37.5x37.5 mm SQ. (1.00 mm pitch), max. grid 36x36 (1,296 pins)
- Two spring probe pin types: SWP for standard and SUS for high temp.
- Buckling beam contact option (applicable for High power applications)
- Modular design allows easy replacement of socket components in the field
- Individual Contact Pins / Contact Pin Module / Heat Sink / Heater / Temp Sensor
- Field replaceable socket cartridge
- Socket Lid and Heat Sink mechanism allow parallel touch down on the PKG
- Detachable Heat Sink
- Low stable contact resistance



Open

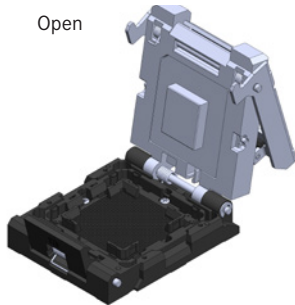

Closed

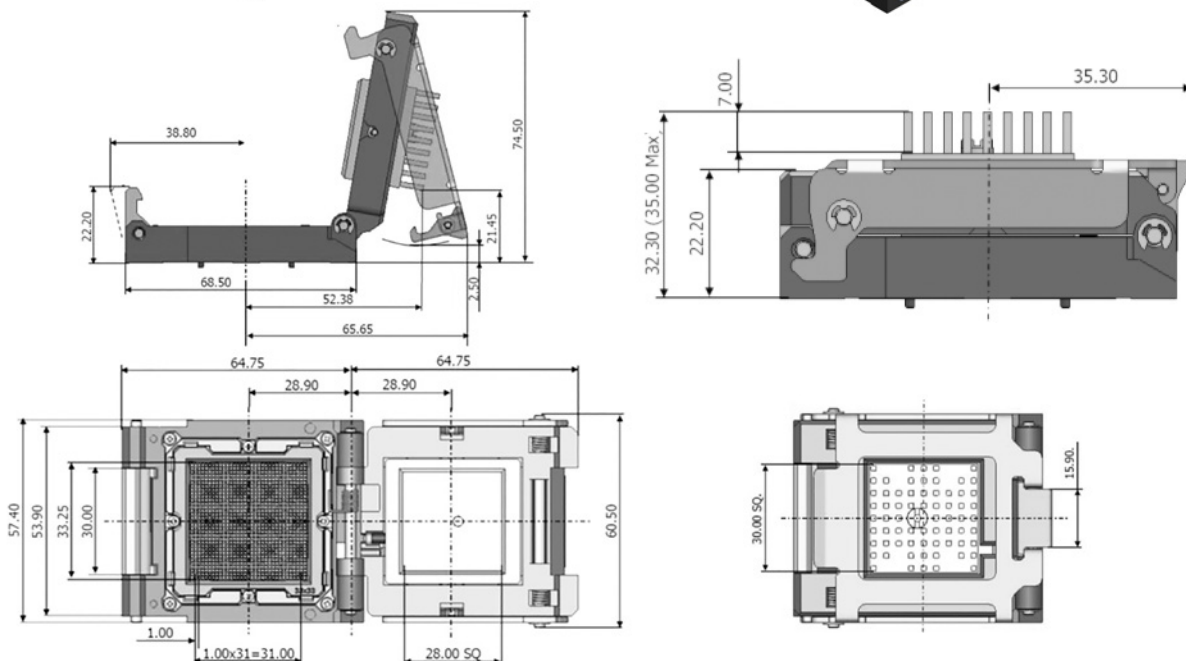
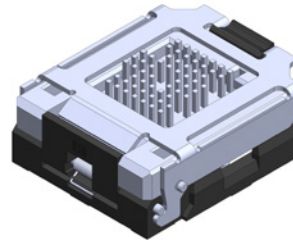

**SPECIFICATIONS**

Insulation Resistance:	>1,000MΩ or more at 100V DC
Dielectric Withstanding Voltage:	100 V AC for 1 minute
Contact Resistance:	< 100mΩ at 10mV mA and 20 mV (initial)
Operating Temp.Range:	-40°C to +150°C
Contact Force:	~0.176N (18.0gf) / pin
Mating Cycles:	10,000 insertions min.

**MATERIALS AND FINISH**

Housing:	Polyester (PES), glass filled Polyether ether ketone (PEEK)
Contacts:	Beryllium Copper (BeCu)
Plating:	Gold over Nickel

**FEATURES**

- Semi custom socket suitable for large BGA, LGA packages
- PKG Dimensions from 13x13 to 32x32 mm SQ (IC603) or 37.5x37.5 mm SQ (IC604)
- MAX grid 39x39 (1,521 pins, IC603) and 36x36 (1,296 pins, IC604)
- Pitch 0.80 mm (IC603) and 1.00 mm (IC604) standard
- Bow type stamped pins (BeCu with NiAu-plating), CCC 2.0 A, Self Inductance 3.79 nH
- Modular design allows easy replacement of socket components in the field
- Unique cam activated lid mechanism
- Dual Lid Design/ Low Actuation Force/ 2-Step Vertical Actuation Motion, for bare die and lidded DUT
- Compression mount for quick installation and maintenance
- Heat Sink / Cartridge Heater / RTD/30K Temp Sensor / Fan (option)
- Customized stiffener shape

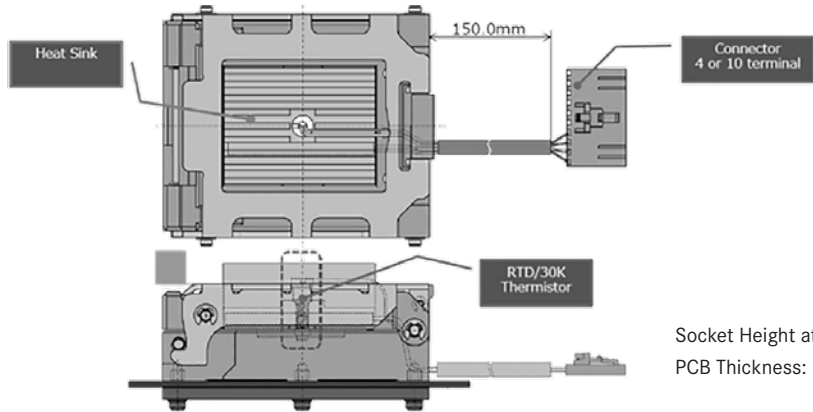

Socket Height at Test: 35.50 mm  
PCB Thickness: 1.60 to 3.00 mm

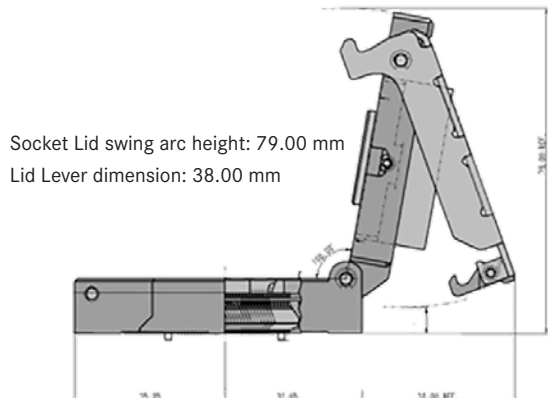
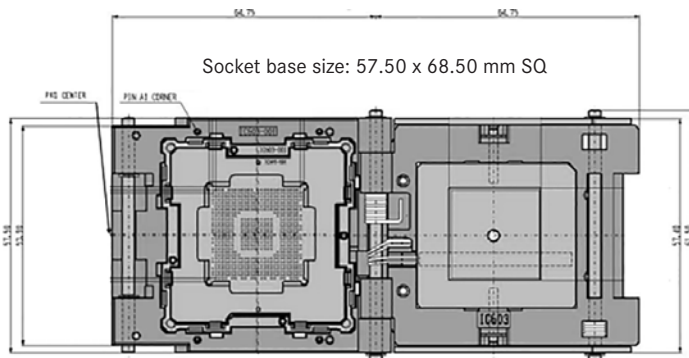

**PART NUMBER**

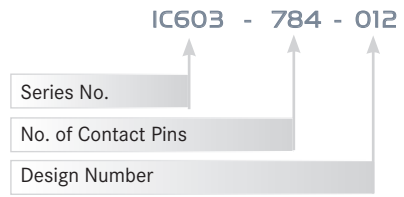

**PART NUMBER**

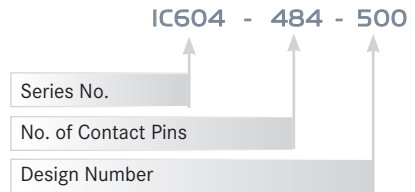

**SPECIFICATIONS**

Insulation Resistance:	>1,000MΩ or more at 100V DC
Dielectric Withstanding Voltage:	100 V DC for 1 minute
Contact Resistance:	< 200mΩ at less than 20mV
Operating Temp.Range:	-40°C to +150°C
Contact Force:	~0.145N (14.8gf) / pin
Mating Cycles:	20,000 insertions min.

**MATERIALS AND FINISH**

Housing:	Polyester (PES), glass-filled Polyetherimide (PEI), glass-filled
Contacts:	Beryllium Copper (BeCu)
Plating:	Gold over Nickel

**FEATURES**

- Semi custom socket suitable for large BGA, LGA packages
- Robust socket structure, reduced number of piece parts
- New component of second latch to moderate contact reaction force via lid
- Pitch 0.80 / 1.00 mm standard
- PKG Dimensions 52x52, max. grid 62x62 (3844 pins) 0.80 mm pitch
- PKG Dimensions 52x52, max. grid 51x51 (2601 pins) 1.00 mm pitch
- PKG Dimensions 59x59, max. grid 73x73 (5329 pins) 0.80 mm pitch
- PKG Dimensions 59x59, max. grid 59x59 (3481 pins) 1.00 mm pitch
- Two spring probe pin types: SWP for standard and SUS for high temp.
- Replaceable contact module
- Individual Contact Pins/ Contact Pin Module/ Heat Sink/ Heater/ Temp Sensor
- Low stable contact resistance

**PART NUMBER (EXAMPLES)**

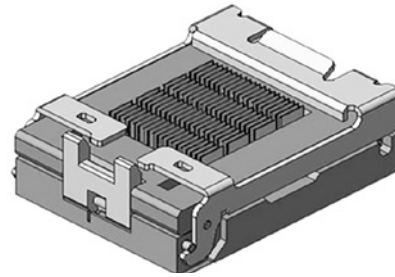
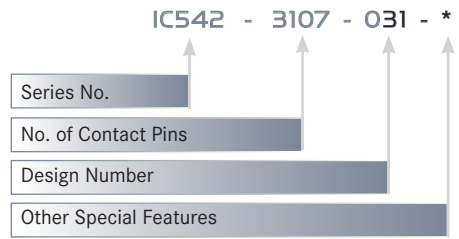

Closed

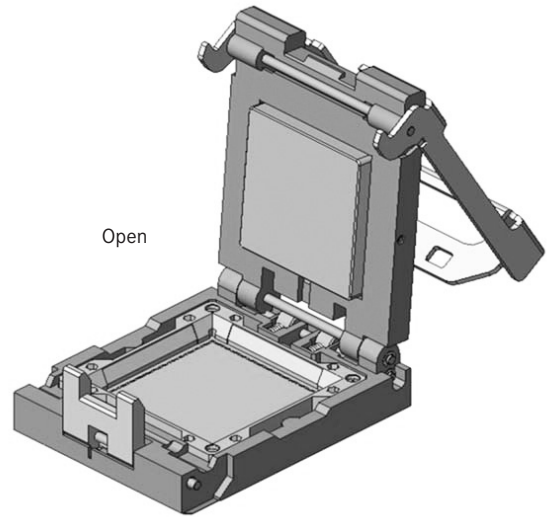

Open

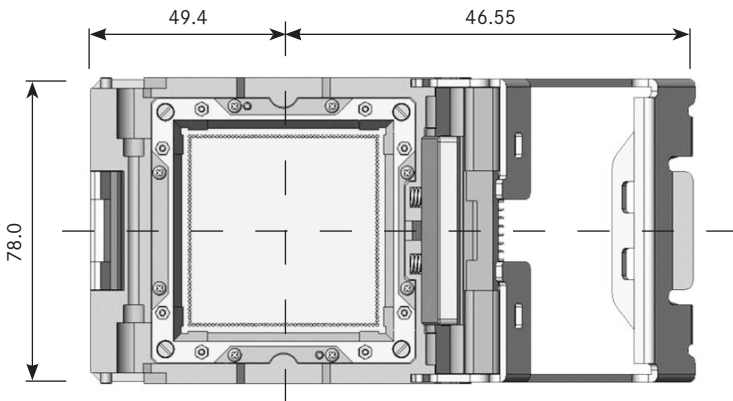

2nd Latch

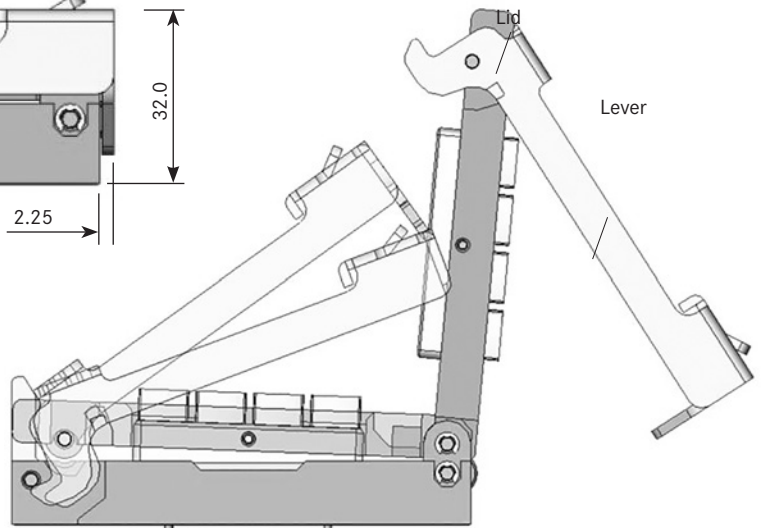
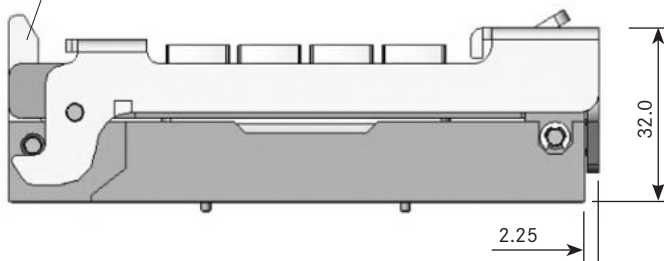

Many packages have an “exposed pad” mainly on the bottom of their bodies (QFPs, QFNs, SOPs,SONs). The main purpose of it is to transfer a GND signal to the PCB and/or, in many cases, to let the heat due to the self-heating of the package flow out of it. In such cases the socket housing the package need to contact the exposed pad through a center or GND pin acting as Heat Slug

**QFP**  
(Quad Flat Package,  
Gullwing Leads)

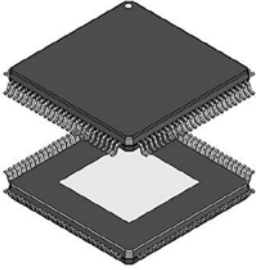

**QFN**  
(Quad Flat No Lead )

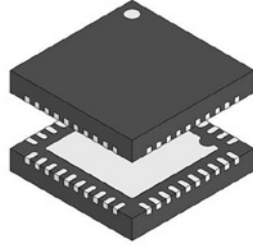

**SOP**  
(Small Outline Package,  
Gullwing Leads)

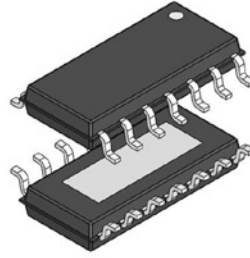

**SONs**  
(Small Outline No Lead)

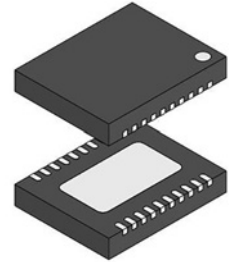

We are able to offer different grounding solutions according to the application

**Solution 1**  
Thermal Big Probe Pin

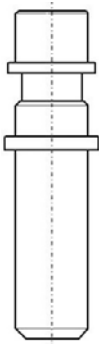

- Use heat dissipation
- Not recommended for electrical
- Combination with other pins cannot be done

**Solution 2**  
Electrical Crown Pin

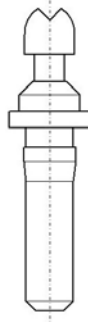

- Use with electrical
- Not recommended for thermal
- Combination with other pins cannot be done

**Solution 3**  
Electrical Press Pin



- Use only electrical
- Not recommended for thermal
- Combination with heat slug can be done and this combination supports the electrical and thermal of a package test

**Solution 4**  
Electrical Probe Pin



- Use only electrical
- Not recommended for thermal
- Combination with heat slug can be done and this combination supports the electrical and thermal of a package test

**Solution 5**  
Electrical Heat Slug

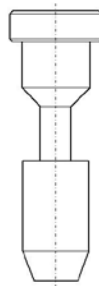

- Use only Thermal
- Not recommended for electrical
- Combination with press pin or probe pin can be done and this combination supports the electrical and thermal of a package test

Many packages requires a thermal management because of their self heating during the tests. Additionally, many tests require a temperature variation sweeping out from low to high ones. It is often required a socket solution able to keep the temperature of the device under test (DUT) as stable as possible to a fixed temperature. Therefore, it is necessary to use a Heat Sink

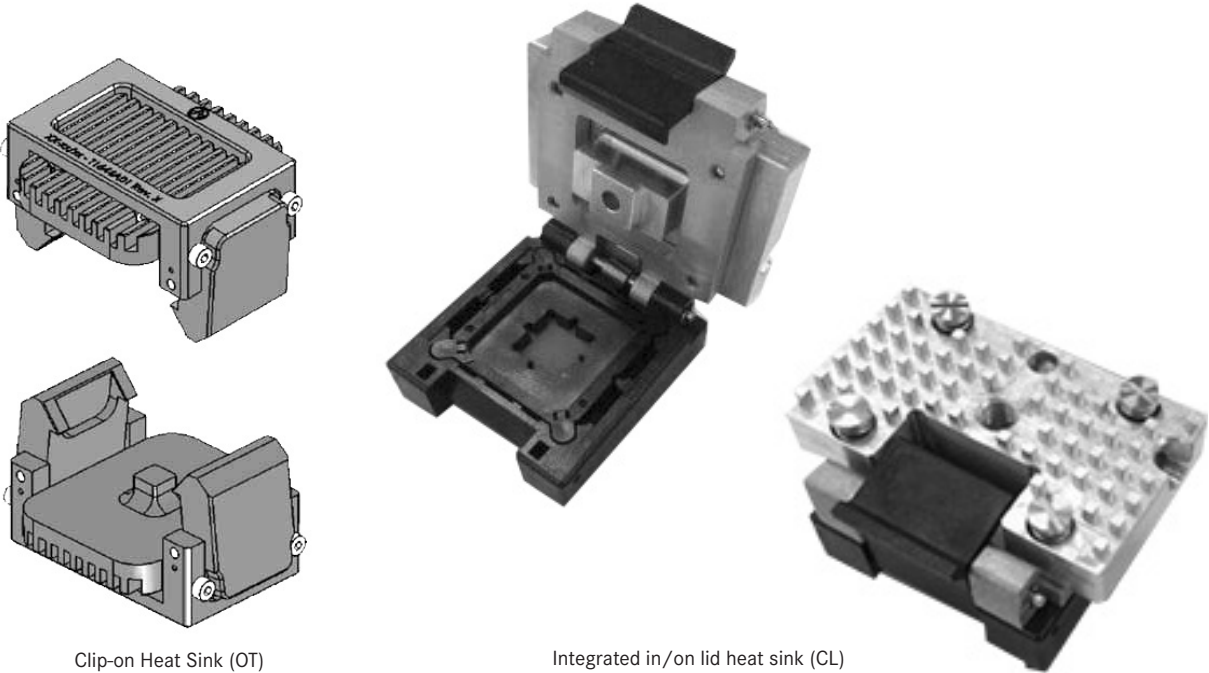

Clip-on Heat Sink (OT)

Integrated in/on lid heat sink (CL)

According to the power dissipated from the device under test (DUT) we can offer two different type of Thermal Management Control

**General purpose heat sink**

Thermal stabilization (Passive Thermal Control)

- Low power dissipation Pd: 0 ~ 5 W
- Aiming to stabilize and / minimize the temperature of the self heating DUT

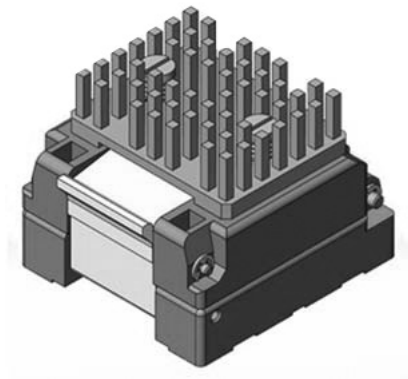

**Custom Heat Sink (heater, sensor, fan)**

Active Thermal Control (ATC)

- Low power dissipation Pd: 5 ~ >50 W
- Aiming to control the temperature of the self heating DUT (additional Hheater, sensor, fan might be needed)

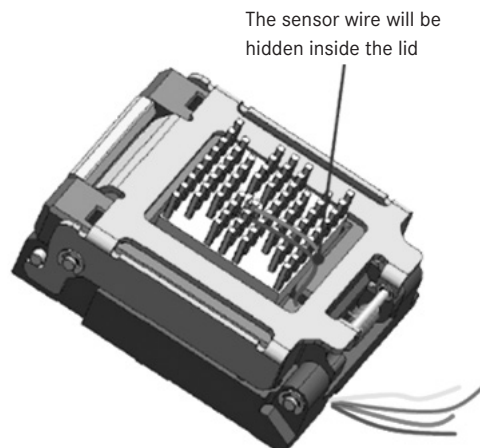



The Test Contactors are design for inital lab testing, HTOL, HAST, ELFR, failure analysis, automated testing, programming and many other applications:

**EXAMPLES**



**FEATURES**

- $\geq 0.3\text{mm}$  pitch
- Open Top
- Removable insert
- Suitable for automated loading system

**FEATURES**

- $\geq 0.3\text{mm}$  pitch
- HF capable
- Designed for customers own requirements
- Very robust design
- Excellent electrical performance

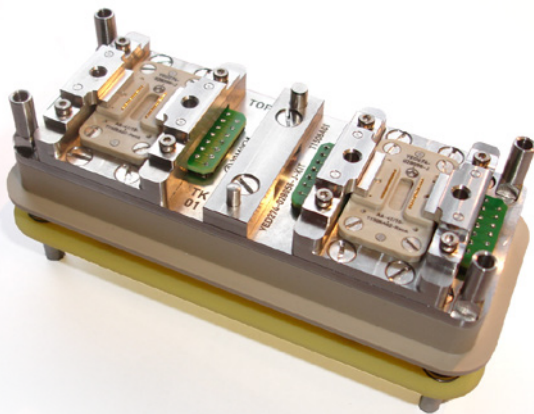

**FEATURES**

- Non Kelvin & Kelvin Test Socket
- Compatible to any Handler System
- Suitable for leaded (SO/QFP), pad (QFN) and balled (CSP/BGA) devices

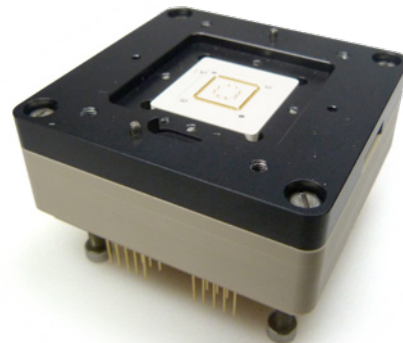

The Yamaichi Electronics YED274 Series include sockets for manual and automated environment. The Test Contactors are design to meet exactly customer requirements and fulfill high performance testing. The Test Contactors can be equipped with standard, low inductance, kelvin, crown and conical style probe pins. Plating options like Palladium and CSH are available on request.

**CUSTOMISED  $\geq 0.30\text{MM}$  PITCH, HINGED TYPE AND VOLUME TEST**

**SPECIFICATIONS**

Contact Resistance:	$\leq 75\text{m}\Omega$
Contact Force (typical):	9 to 28gf
Operating Temp. Range:	$-40^{\circ}\text{C}$ to $+125^{\circ}\text{C}$
High Temperature Range:	$-55^{\circ}\text{C}$ to $+150^{\circ}\text{C}$
Mating Cycles:	500,000 insertions min.

**MATERIALS AND FINISH**

Housing:	PEEK / Anodized Aluminum
Contacts:	Beryllium Copper (BeCu) (Typical)
Plating:	Gold over Nickel (Typical)

Other materials are available on request

**FEATURES**

- Customised Test Contactor
- Open Top and Easy-Close cover
- Outstanding performance
- Higher temperature range available
- Optional: Serial number and data matrixcode

**PART NUMBER**

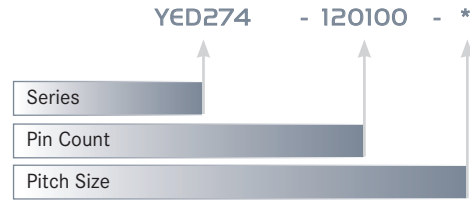

**TYPICAL PIN TIP STYLES**

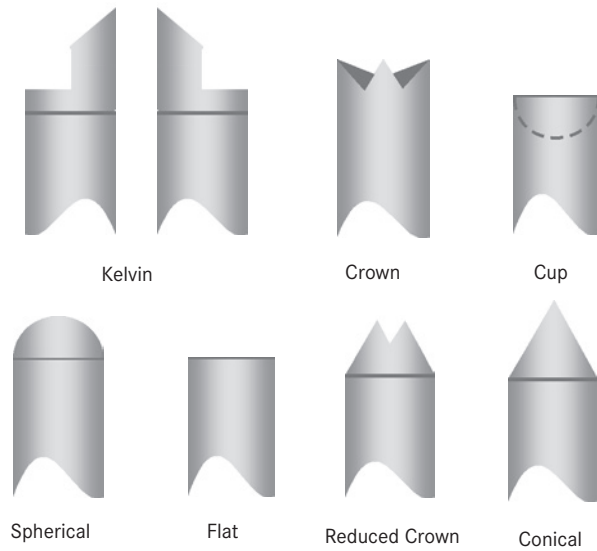

**TYPICAL EXAMPLE OF PIN CHARACTERISTICS\***

\* 0.35mm pitch configuration, values based on internal Yamaichi testing

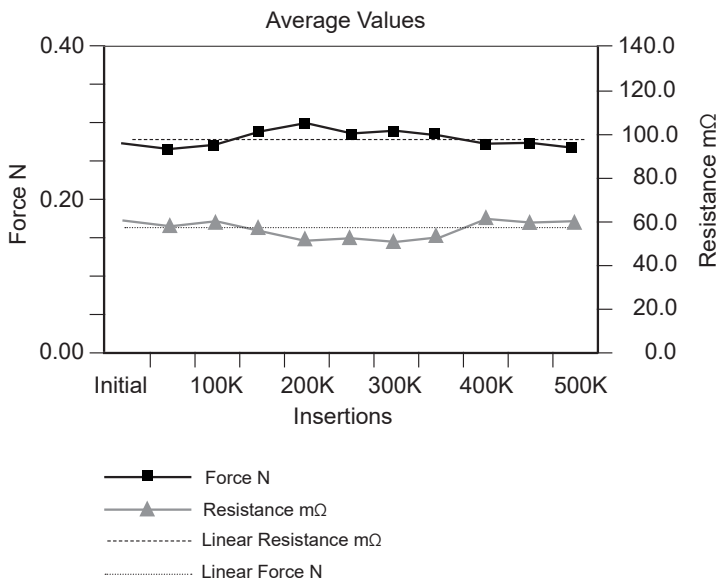

**Lumped Coupled Model**

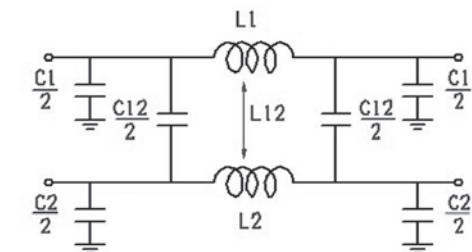

Self Inductance	L1 - L2	0.505 nH
Mutual Inductance	L12	0.110 nH
Self Capacitance	L1 - L2	0.223 pF
Mutual Capacitance	C12	0.069 pF

The Yamaichi Electronics YED254 Series include sockets for manual usage only. The Test Contactors are limited up to 50,000 insertions and approx. 200 probe pins. The Test Contactors can be equipped with standard, low inductance, crown and conical style probe pins. Plating options like Palladium and CSH are available on request.

**CUSTOMISED  $\geq 0.30\text{MM}$  PITCH AND HINGED TYPE**

**SPECIFICATIONS**

Contact Resistance:	$\leq 75\text{m}\Omega$
Contact Force (typical):	9 to 25gf
Operating Temp. Range:	$-40^{\circ}\text{C}$ to $+125^{\circ}\text{C}$
High Temperature Range:	$-55^{\circ}\text{C}$ to $+150^{\circ}\text{C}$
Electrical performance:	on request
Mating Cycles:	50,000 insertions min.

**MATERIALS AND FINISH**

Housing:	PEEK / Anodized Aluminum
Contacts:	Beryllium Copper (BeCu) (Typical)
Plating:	Gold over Nickel (Typical)

Other materials are available on request

**FEATURES**

- Customised Test Contactor
- Easy-close cover
- Outstanding performance
- Lab applications
- Higher temperature range available
- Optional: Serial number and data matrix code

**PART NUMBER**

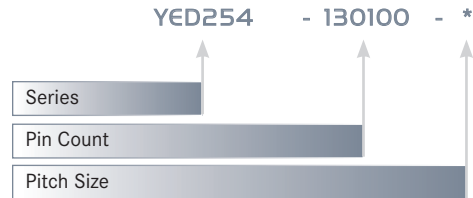

**TYPICAL PIN TIP STYLES**

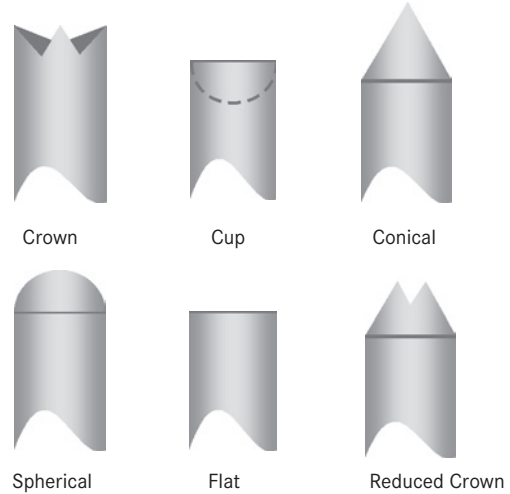

**TYPICAL EXAMPLE PIN CHARACTERISTICS\***

\* 0.40mm pitch configuration, values based on internal Yamaichi testing

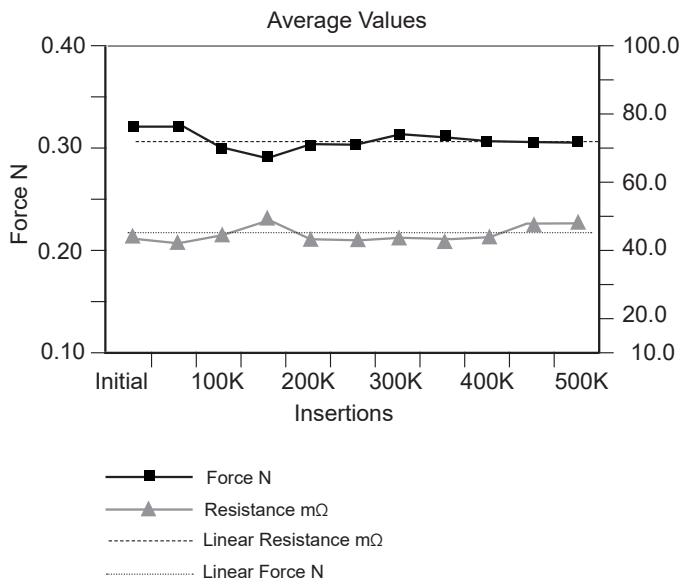

**Lumped Coupled Model**

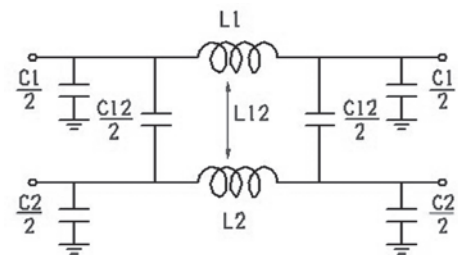

Self Inductance	L1 - L2	0.933 nH
Mutual Inductance	L12	0.149 nH
Self Capacitance	L1 - L2	0.629 pF
Mutual Capacitance	C12	0.129 pF

The Test Contactors are design for initial lab testing, HTOL, HAST, ELFR, failure analysis and many other applications:

EXAMPLES

**FEATURES**

- Small outline
- Low pin count
- ePad contact for QFN/SO/QFP
- Spring loaded lid

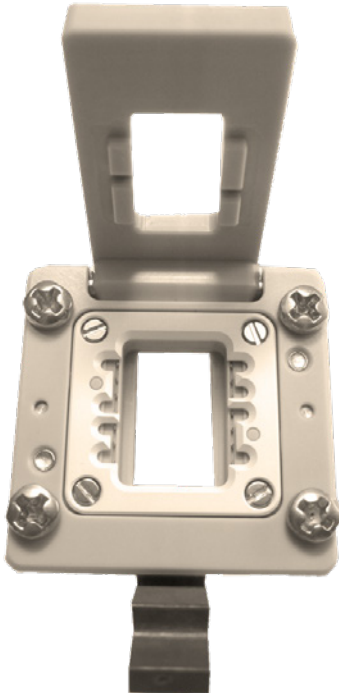

**FEATURES**

- Customized footprint
- Lead spacer for optimized device guiding for QFP / SO devices
- High performance materials

**FEATURES**

- Suitable for microscopes
- Optional optical glass / plastics
- Customized socket footprint
- Outer dimensions according to customer requirements

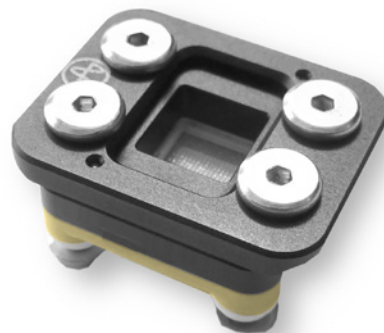



Y-RED is a unique contact unit design with top side access which enables the customer to exchange the insert without disassembly of the complete test setup.

Our designers implemented many useful features for simple operation with high reliability and high insertion/extraction cycles.



## RAPID

design and manufacturing guarantees that our customers are ready for test when the silicon arrives. The “time to customer” is just 3-4\* weeks between inquiry and product delivery.

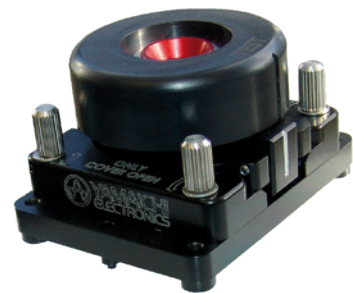

## EFFICIENT

test hardware utilisation is the key for customer’s success. The easy attachable screw-on hand test cover combined with an overall poka-yoke design helps to minimize changeover times.

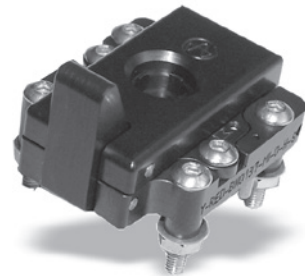

## DURABLE

robust design and excellent electrical performance leaves nothing to be desired.

### HIGH PERFORMANCE SPRING PROBE PINS

- Excellent reliability
- Low contact resistance <math><50\text{m}\Omega</math>
- Outstanding mating cycles 500k
- Ultra low pitch capability
- Crown and conical plunger styles
- Standard and High Temperature



\*depending on engineering and factory capacity

HINGED TYPE AND VOLUME TEST

SPECIFICATIONS

Contact Resistance:	<50mΩ
Contact Force:	25gf
Operating Temp. Range:	-40°C to +125°C
High Temperature Range:	-55°C to +150°C
Mating Cycles:	500,000 insertions min.

MATERIALS AND FINISH

Housing:	PEEK / Anodized Aluminium
Contacts:	Beryllium Copper (BeCu)
Plating:	Gold over Nickel

FEATURES

- Test Contactor for BGA, CSP, QFN and LGA packages
- Outstanding performance
- For Lab and volume test applications

PART NUMBER

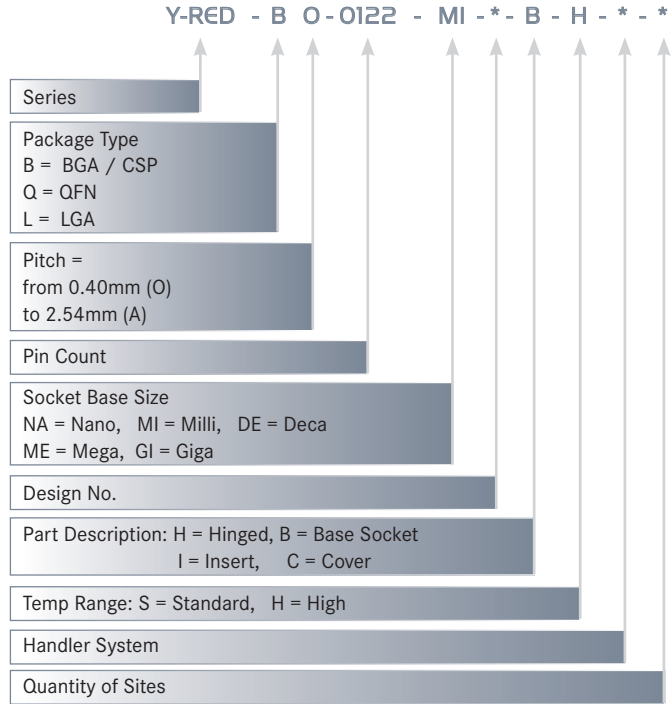

PRODUCT RANGE

	NANO	MILLI	DECA	MEGA	GIGA
Package Dimensions	≤ 6 x 6mm	> 6 x 6mm / ≤ 12 x 12mm	> 12 x 12mm / ≤ 22 x 22mm	> 22 x 22mm / ≤ 35 x 35mm	> 35 x 35mm / ≤ 45 x 45mm
Cover Type	TWIST	TWIST	TWIST and HPC	High Pressure Cover (HPC)	High Pressure Cover (HPC)
Temperature Range	Standard Temperature = -40°C to +125°C / High Temperature = -55°C to +150°C				
Package Types	BGA / CSP / QFN / LGA				
Device (Pitch)	≥ 0.4mm				

ORDERING CODES FOR CONTACT TYPES

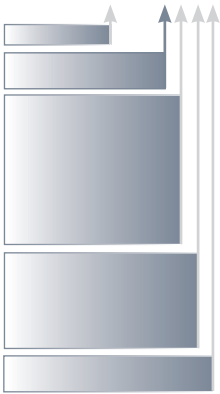

Code	Tail Length
A	4.57mm
B	6.99mm
C	10.16mm

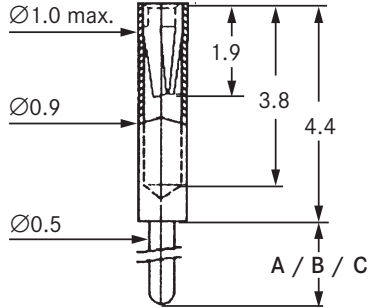

Code	Tail Length
D	2.52mm

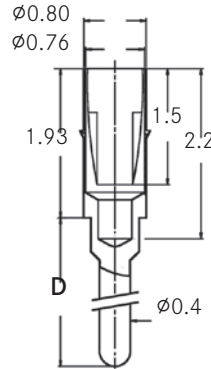

Code	Tail Length
S	6.35mm

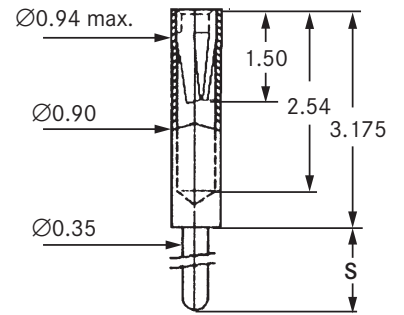

RECEPTACLE EXAMPLES

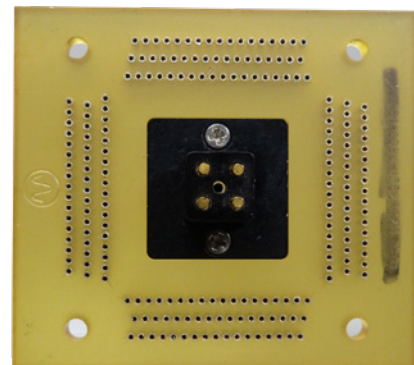
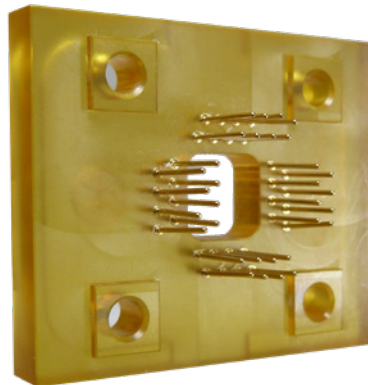

FEATURES

- Robust design
- Usable in ATE applications
- Reliable contacts
- Customised design



**APPLICATION** The receptacle is used as an additional adapter between the PCB and the Test or Burn-In socket, to make the socket removeable.

**MATERIAL**

- Insulator - Various Selctions e.g. PEI, PEEK...
- Inner Contact - Gold plating over Nickel plating
- Outer Sleeve - Gold plating over Nickel plating

**PITCH**  $\geq 1.27\text{mm}$  is Standard Pitch  
1.00mm is Fine Pitch

**OPERATING TEMP. RANGE** -40°C to +150°C

**RoHS COMPLIANT**

**PART NUMBER (DETAILS)**

**REFERENCE GUIDE FOR CODE NO:** SOCKET SERIES CODE NO. 51 - 1004-814 - A 2 \* \* - YED

SOCKET SERIES (examples)	CODE	CONTACT TYPES
NP276	276	S
IC51	51	A, B, C
IC234	234	A, B, C
IC357	357	D

These socket series also have many various and customised types available.

For more information please contact Yamaichi sales department

Pin Count / Socket Type		
Contact Type (see codes next page)		
Insulator Plate Thickness		
Code	Dimnensions	
1	3.17mm Standard	no groove possible contact type S only
2	4.45mm	Groove optional
3	5.21mm	Groove optional
4	5.84mm	Groove optional
5	6.00mm	Groove optional
6	6.50mm	Groove optional
7	8.00mm	Groove optional
8	3.48mm	Contact type D only
Receptacle Type		
For special Requests (eg Stand-off and Customer Specific)		

## YAMAICHI SPRING PROBE PINS - AN EXCELLENT CHOICE -

Task of the spring probe pin is to establish reliable contact to different IC packages such as QFP, BGA, QFN, LGA, and other semiconductor components with a pitch from  $\geq 0.3$  mm (ultra-low pitch) to 2.54 mm.

Besides semiconductor, wafer-level contacting and sensor testing, our spring probe pins can be used in areas such as medical/space, application testing, failure analysis, programming, burn-in (HAST/THB), PCB testing, and board-to-board connectors.

Contact reliability is the aim.

The concept of the spring contact combines guaranteed excellent mechanical and electrical characteristics:

- Durable stable contact design with simultaneous lowest mechanical contact wear, i.e. no degradation of the contact force as well as minimised contact movement on the IC component or PCB contact pad.
- Low contact resistance ( $< 50\text{m}\Omega$ ), even with differing surfaces.

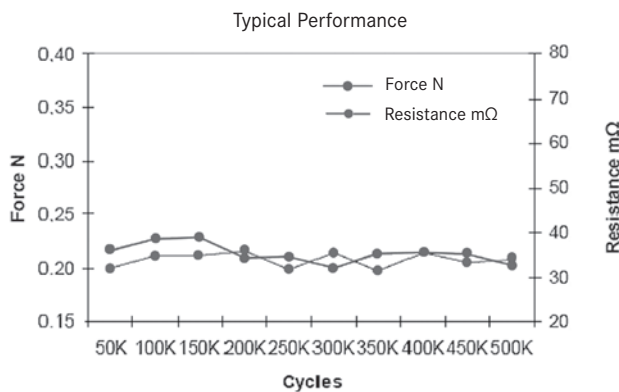

Example: W-030/570-CTCO-P56

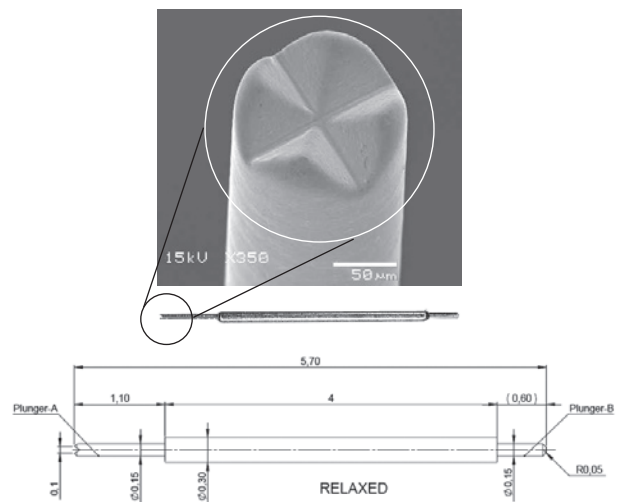

### GENERAL SPECIFICATIONS

Mating Cycles:	>500,000
Contact resistance:	<50mΩ
Contact force:	~25gf (typical)
Length:	Starting from 1.00mm
Diameter:	> 0.125mm
Operating temp. range:	-40°C to +150°C

### APPLICATIONS

- Semiconductor / Sensor Test
- Medical Application Test
- Space Application Test
- Failure Analysis
- Programming
- Burn-In / HAST / THB

### FEATURES

- Excellent reliability
- Low contact resistance
- Outstanding mating cycles
- Ultra low pitch capability
- Broad variety of dimensions & plunger types



## PART NUMBER (DETAILS)

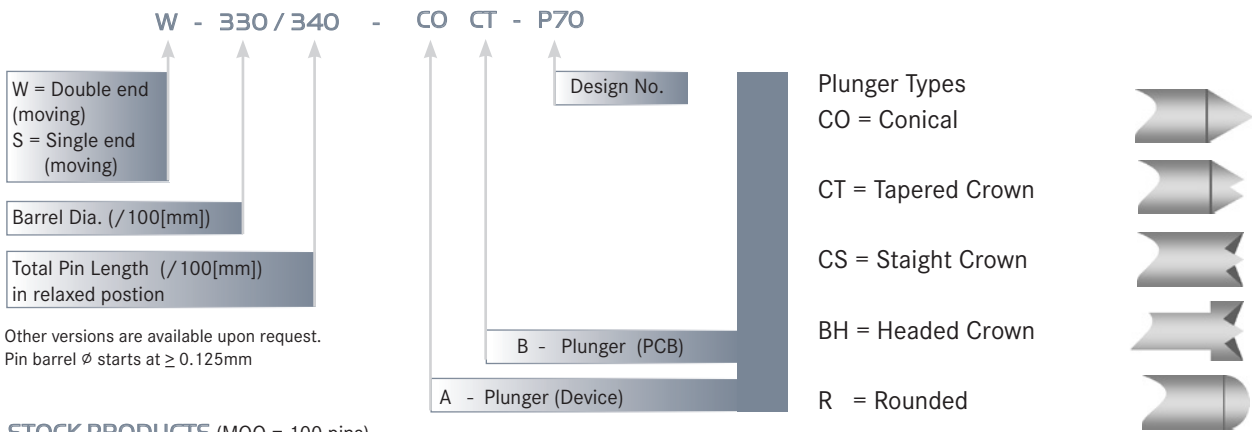

## STOCK PRODUCTS (MOQ = 100 pins)

## 0.40MM PITCH

Drawing Number	Barrel Dia. (mm)	Total Pin Length (mm) (relaxed)	A Plunger Shape	B Plunger Shape	Working Position (mm)	Stroke (mm)	Contact Force @ Working Pos (gf).
W-030/340-CTCO-P76	0.30	3.40	TAPERED CROWN	CONICAL	3.10	0.30	14.0
W-030/570-CTCO-P56	0.30	5.70	TAPERED CROWN	CONICAL	5.05	0.65	20.0
W-030/570-COCO-P81	0.30	5.70	CONICAL	CONICAL	5.05	0.65	20.0
W-030/340-CTCT-P58	0.30	3.40	TAPERED CROWN	TAPERED CROWN	3.10	0.30	20.0
S-026/518-COCO-P18	0.26	5.18	CONICAL	CONICAL	4.80	0.38	20.0

## 0.50MM PITCH

Drawing Number	Barrel Dia. (mm)	Total Pin Length (mm) (relaxed)	A Plunger Shape	B Plunger Shape	Working Position (mm)	Stroke (mm)	Contact Force @ Working Pos (gf)..
W-038/480-CTCO-P47	0.38	4.80	TAPERED CROWN	CONICAL	4.25	0.55	25.0
W-035/762-CTCO-P35	0.35	7.62	CONICAL	CONICAL	7.00	0.62	20.0
W-035/762-CTCO-P04	0.35	7.62	TAPERED CROWN	CONICAL	7.00	0.62	20.0
W-035/686-COCO-P11	0.35	6.86	CONICAL	CONICAL	6.22	0.64	20.0
W-035/762-CTCO-P14	0.35	7.62	TAPERED CROWN	CONICAL	7.00	0.62	20.0
W-035/195-CTCO-P61	0.35	1.95	TAPERED CROWN	CONICAL	1.65	0.30	17.5
W-035/195-COCO-P73	0.35	1.95	TAPERED CROWN	CONICAL	1.65	0.30	17.5

## 0.65MM PITCH

Drawing Number	Barrel Dia. (mm)	Total Pin Length (mm) (relaxed)	A Plunger Shape	B Plunger Shape	Working Position (mm)	Stroke (mm)	Contact Force @ Working Pos. (gf).
W-050/330-CTCO-P49	0.50	3.30	TAPERED CROWN	CONICAL	2.90	0.40	30.0
W-050/330-CTCO-P49C	0.50	3.30	TAPERED CROWN	CONICAL	2.90	0.40	30.0
W-050/330-CTCO-P46	0.50	3.30	TAPERED CROWN	CONICAL	2.95	0.35	26.0

## 0.75MM PITCH

Drawing Number	Barrel Dia. (mm)	Total Pin Length (mm) (relaxed)	A Plunger Shape	B Plunger Shape	Working Position (mm)	Stroke (mm)	Contact Force @ Working Pos (gf).
W-058/865-CTCO-P07	0.58	8.69	TAPERED CROWN	CONICAL	7.92	0.77	30.0
W-058/696-CTCT-P01	0.58	6.96	TAPERED CROWN	TAPERED CROWN	6.20	0.76	42.0
W-057/490-CSC0-P55	0.57	4.90	STRAIGHT CROWN	CONICAL	4.30	0.60	25.0

## 1.00MM PITCH

Drawing Number	Barrel Dia. (mm)	Total Pin Length (mm) (relaxed)	A Plunger Shape	B Plunger Shape	Working Position (mm)	Stroke (mm)	Contact Force @ Working Pos.(gf)
W-076/863-BHCT-P69	0.76	8.83	HEADED CROWN	TAPERED CROWN	7.27	1.36	30.0

## 1.27MM PITCH

Drawing Number	Barrel Dia. (mm)	Total Pin Length (mm) (relaxed)	A Plunger Shape	B Plunger Shape	Working Position (mm)	Stroke (mm)	Contact Force @ Working Pos (gf).
W-102/863-BHR-P70	1.02	8.63	HEADED CROWN	ROUNDED	7.27	1.36	40.0
W-102/863-BHCT-P68	1.02	8.63	HEADED CROWN	TAPERED CROWN	7.27	1.36	40.0

# PCB SOLUTIONS

An adapter board acts as a mechanical and electrical interface between the tester (ATE) and the device under test (DUT). The range of such an adaptation can vary from very simple to quite complex where it has well-defined physical dimensions and it must fit perfectly into the tester environment.

A properly designed adapter board is electronically “invisible”, and does not introduce any distortion or delay to the DUT signals. The adapter board should be able to support all the tests executed on the tester and be flexible enough to support future testing.

Yamaichi Electronics adapter boards are impedance controlled and able to deal with critical signals up to the higher Giga Hertz range. Onboard measurement capabilities and a contact clearance down to 0.3mm complete this solution.

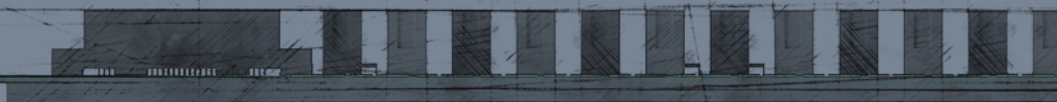

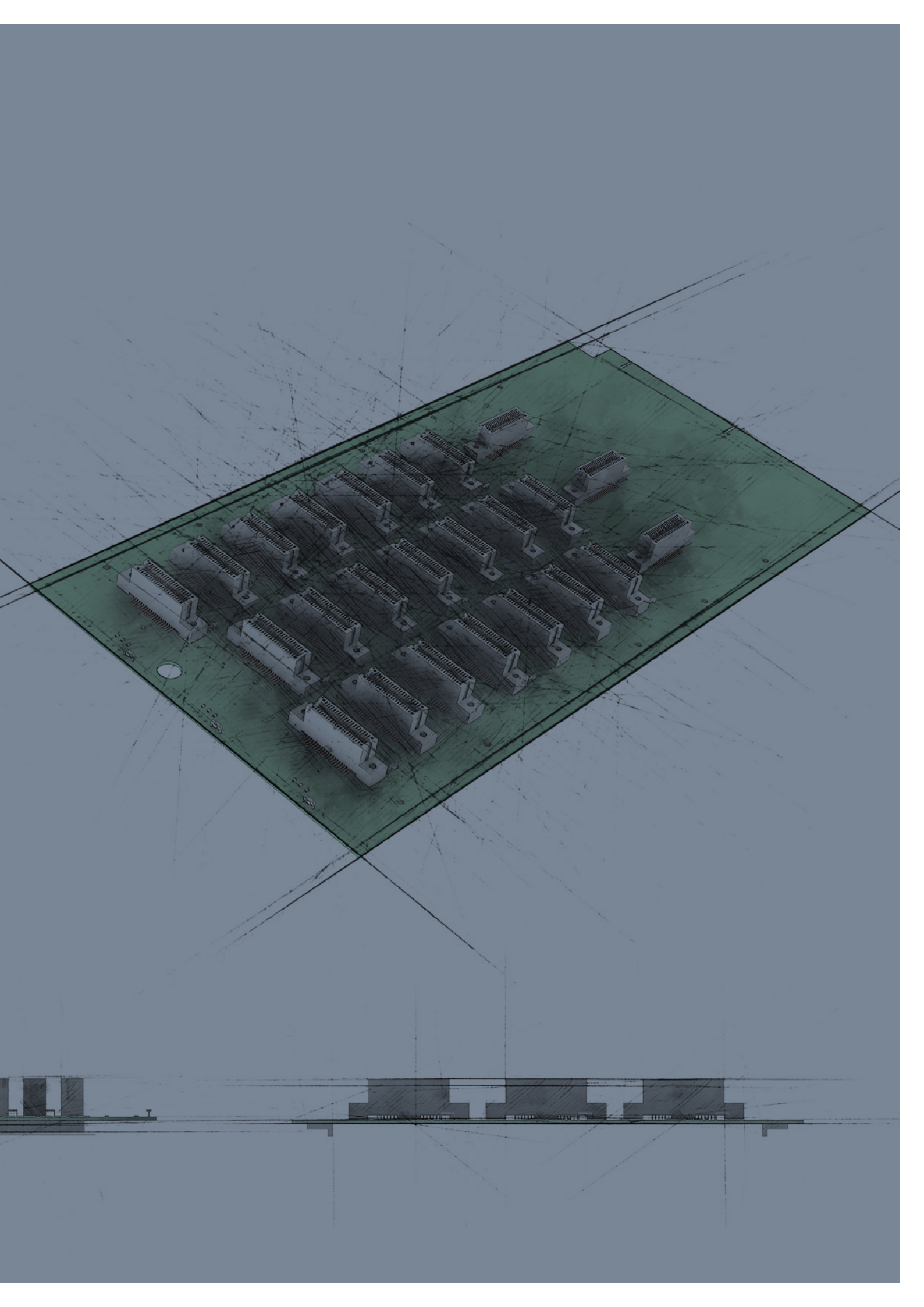

**YAMAICHI PCB-DESIGN  
- EXCEED EXPECTATIONS -**

Providing full functional PCB's according customers specification is not just an order – deliver process it's even more an based on close partnership development process.

Our aim is to get the whole picture of your need's - bring in our experience of more than 20 years - and express potential concerns clearly from the beginning.  
We belief that this very close coordination finally leads to superior products and ensure a plug-and-play functionality.

Client-specific dedication is the “fuel” which generates innovative solutions.

Take all aspects under consideration by using the “tools”

- Dedication
- Experience
- Creativity
- Latest tools

leads to highest possible degree of quality and cost-effective solutions.

Be with us and discover another dimension!

As a full service provider we offer

- Design (PCB / Hardware)
- Simulations (Electrical / Thermal)
- Manufacturing
- Assembly
- Consulting service

**WORK FLOW  
EXAMPLE**

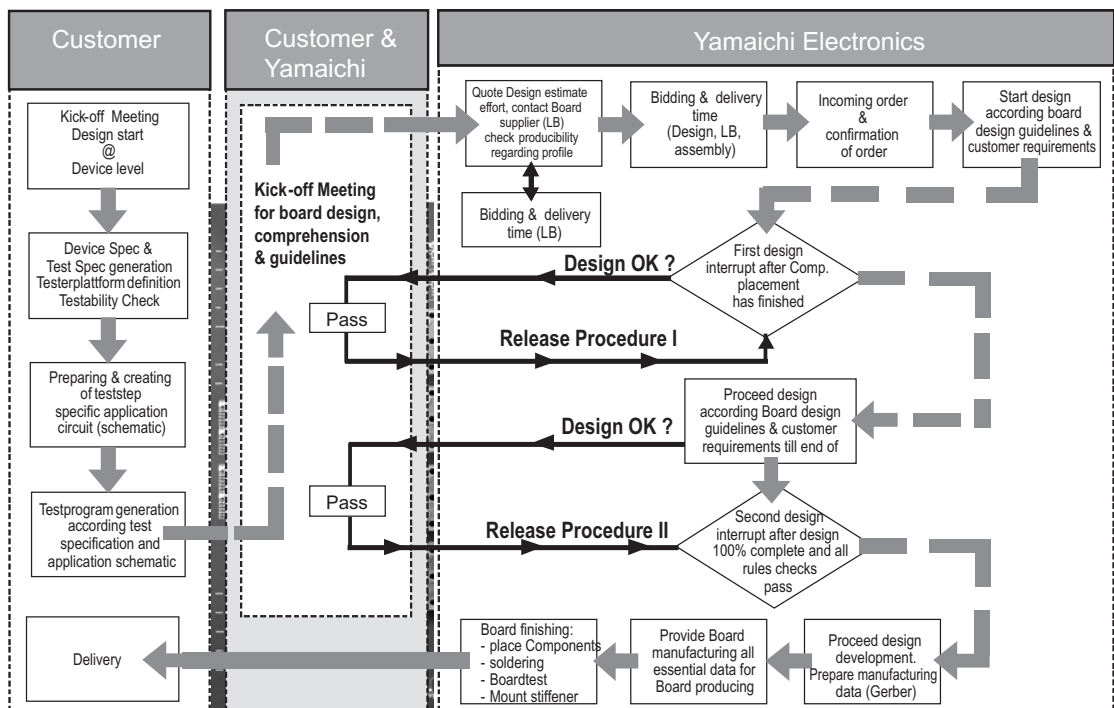

DESIGN EXAMPLES

- ATE TEST BOARD
- DIB
- WAFER TEST (VERTICAL PROBE)
- FINAL TEST (MULTI SIDE (QUAD))

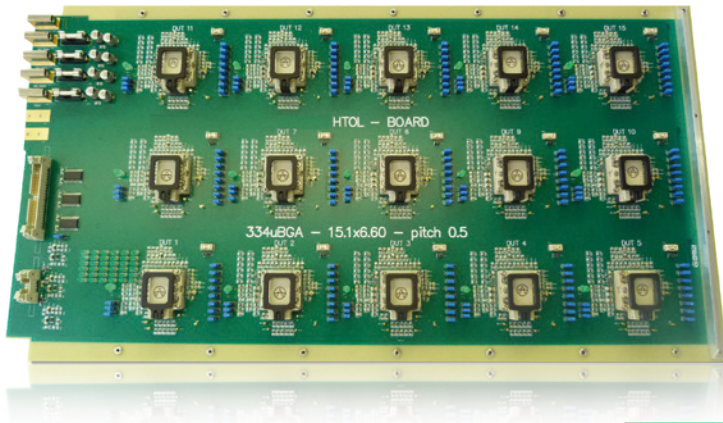
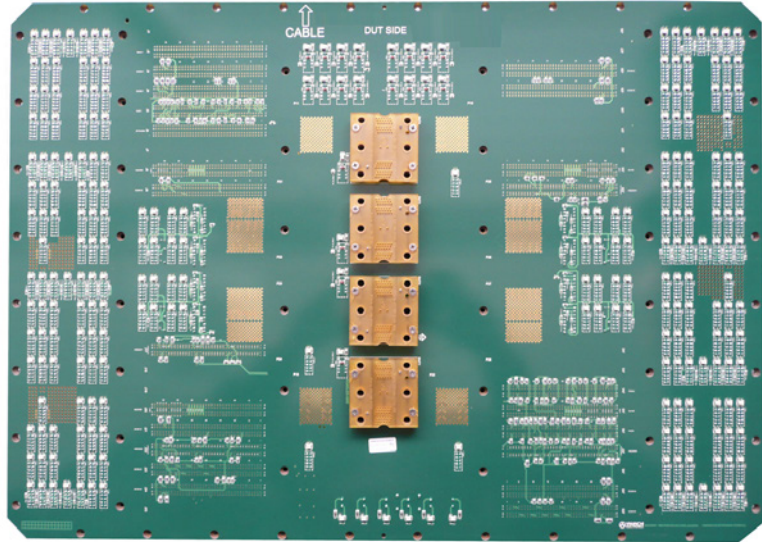

HTOL TEST BOARD

POWER BURN-IN  
DRIVER BOARD

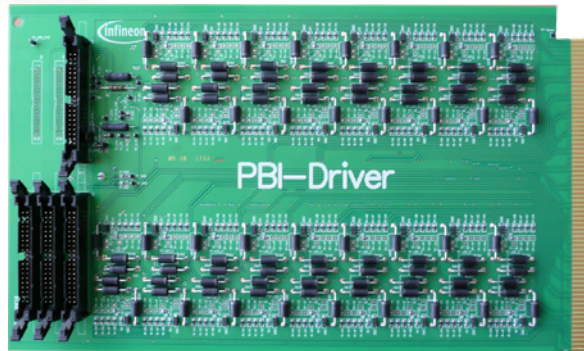

QUALIFICATION TEST  
BOARD

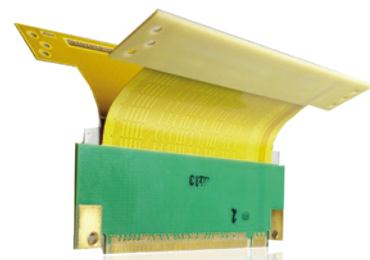
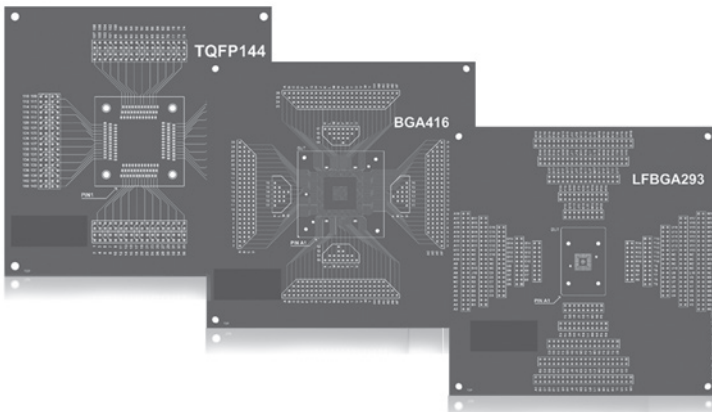

RIGID / FLEX ML-BOARD,  
FULL IMPEDANCE CONTROLLED

# CONTACTING MODULES

An adapter board acts as a mechanical and electrical interface between the tester (ATE) and the device under test (DUT). The range of such an adaption can vary from very simple to quite complex where it has well-defined physical dimensions and it must fit perfectly into the tester environment.

A properly designed adapter board is electronically “invisible”, and does not introduce any distortion or delay to the DUT signals. The adapter board should be able to support all the tests executed on the tester and be flexible enough to support future testing.

Yamaichi Electronics adapter boards are impedance controlled and able to deal with critical signals up to the higher Giga Hertz range. Onboard measurement capabilities and a contact clearance down to 0.3mm complete this solution.

Test Contactors - Series YED274.....	64 - 67
Test Contactor - SERIES Y-RED Modular.....	68 - 69
Receptacles .....	70 - 71
Spring Probe Pins .....	72 - 73
Memory Modules.....	72 - 73
Card Edge Connectors.....	89 - 90



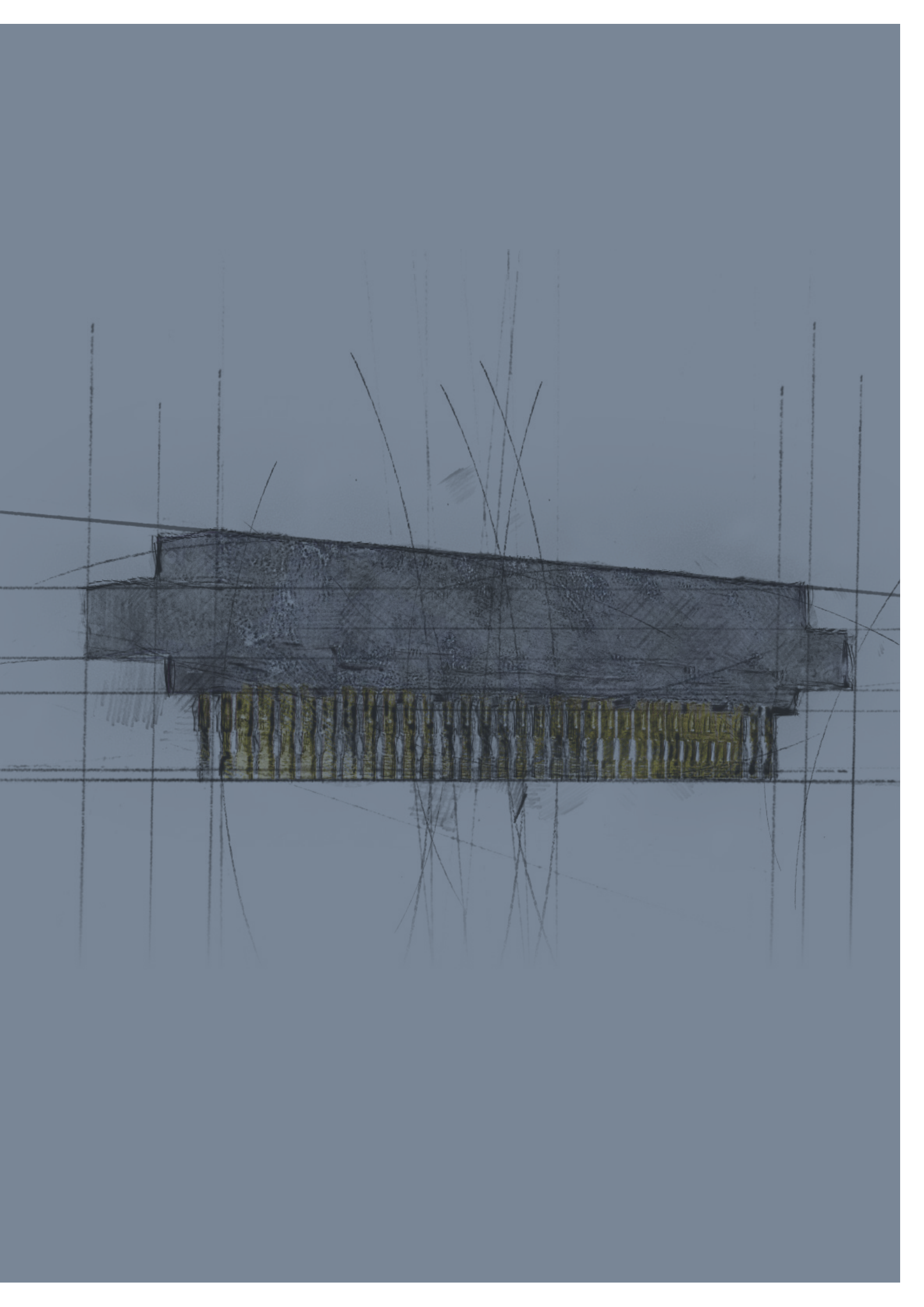

**SPECIFICATIONS**

Insulation Resistance:	1,000MΩ min. at 500V DC
Dielectric Withstanding Voltage:	700V AC for 1 minute
Contact Resistance:	30mΩ max. at 10mA/20mV max.
Operating Temperature Range:	-55°C to +170°C
Mating Cycles:	10,000 insertions

**MATERIALS AND FINISH**

Housing:	Polyetherimide (PEI), glass-filled
Contacts:	Beryllium Copper (BeCu)
Plating:	Gold over Nickel

**FEATURES**

- 72 contact pins
- Card thickness 1.00mm

**PART NUMBER**

**IC-554 - 1 - MF**

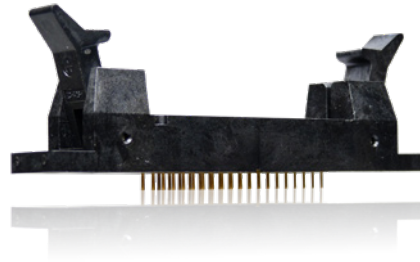
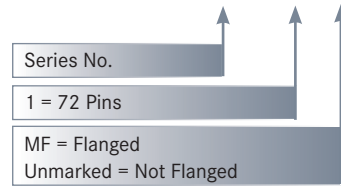

**OUTLINE SOCKET DIMENSIONS**

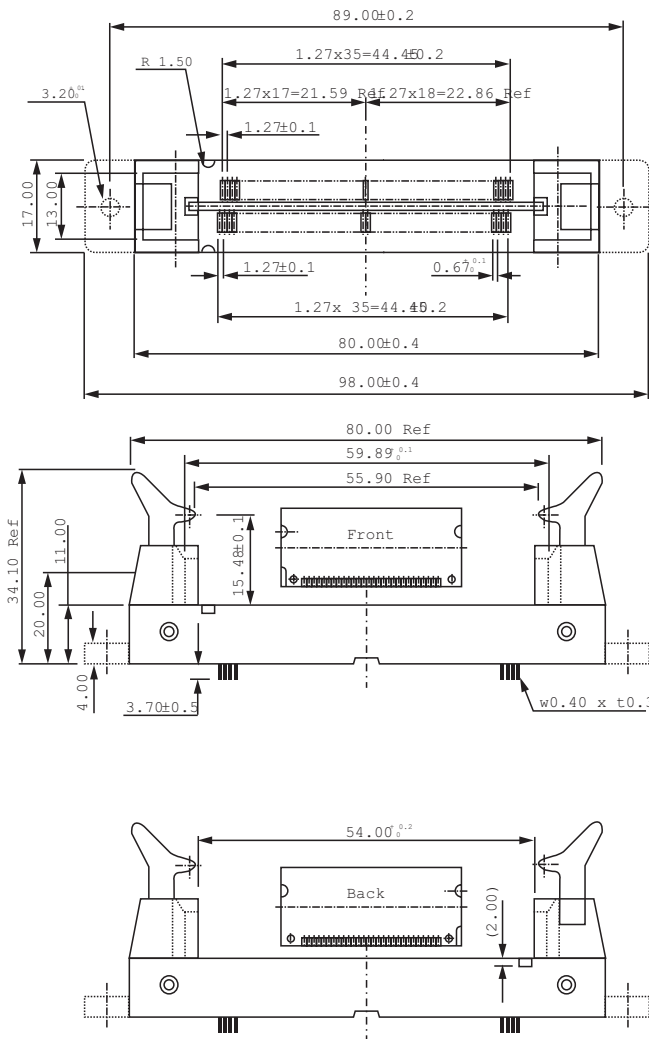

**RECOMMENDED PCB LAYOUT**

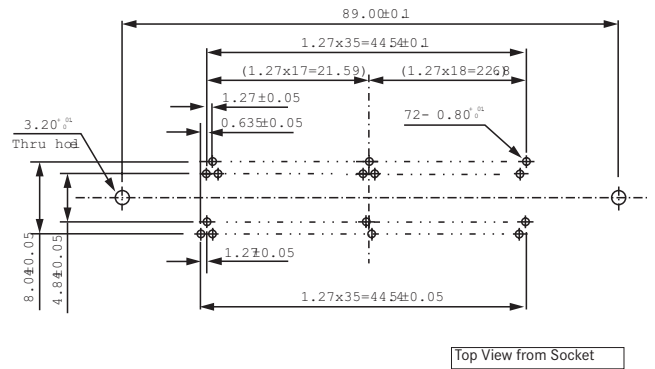

**MATCHING MODULE DIMENSIONS**

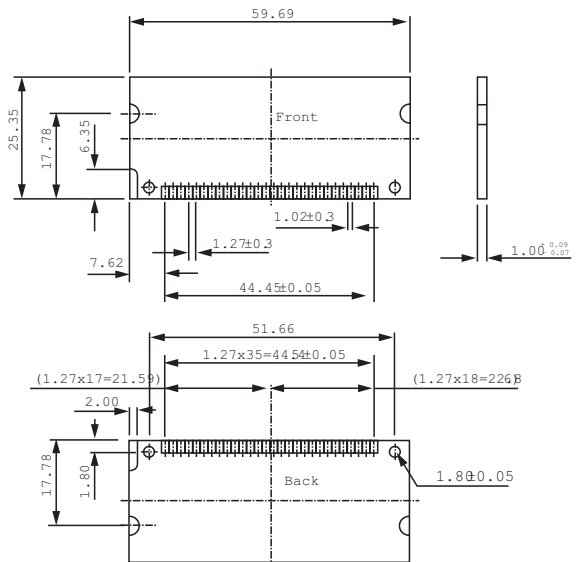

**SPECIFICATIONS**

Insulation Resistance:	1,000MΩ min. at 500V DC
Dielectric Withstanding Voltage:	700V AC for 1 minute
Contact Resistance:	30mΩ max. at 10mA/20mV max.
Operating Temperature Range:	-55°C to +170°C
Mating Cycles:	10,000 insertions min.

**MATERIALS AND FINISH**

Housing:	Polyetherimide (PEI), glass-filled
Contacts:	Beryllium Copper (BeCu)
Plating:	Gold over Nickel

**FEATURES**

- 144 contact pins
- Card thickness 1.00mm
- 4 different positioning indicators

**PART NUMBER**

IC-497 - 1 - \* MF

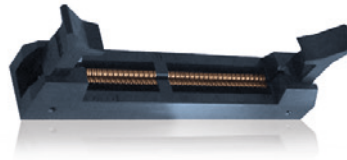
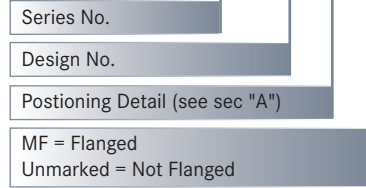

**OUTLINE SOCKET DIMENSIONS**

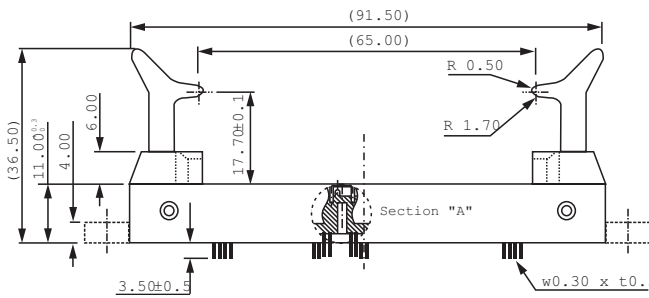
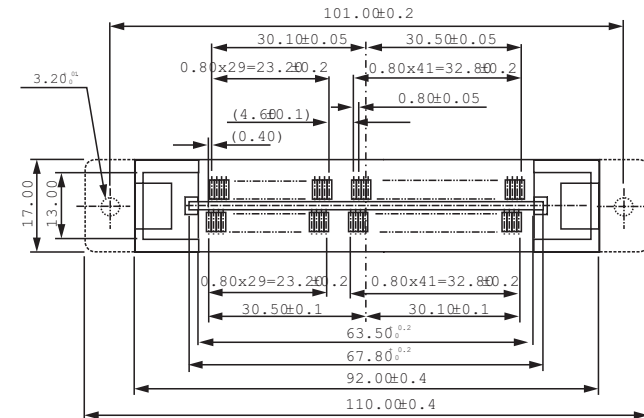

**POSITIONING PINS**

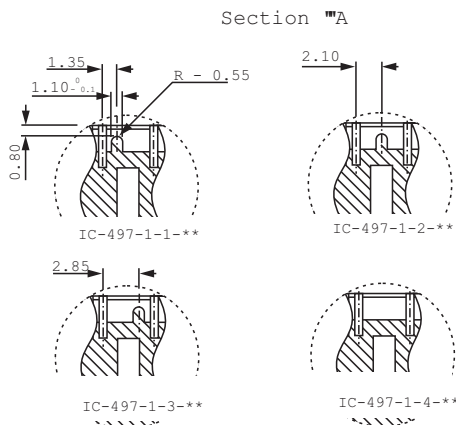

**RECOMMENDED PCB LAYOUT**

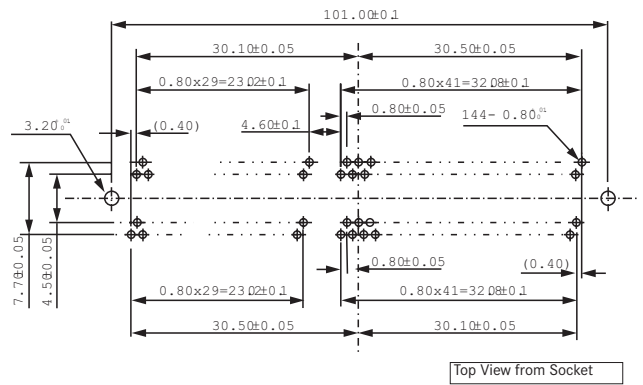

**MATCHING MODULE DIMENSIONS**

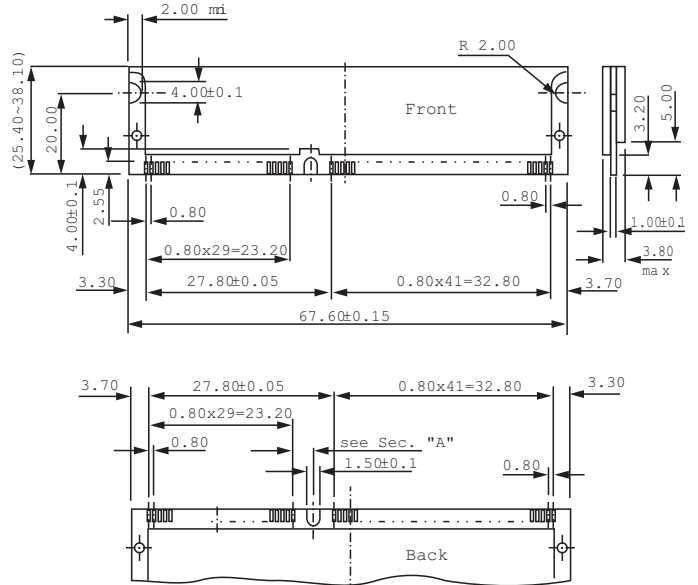

**SPECIFICATIONS**

Insulation Resistance:	1,000MΩ min. at 500V DC
Dielectric Withstanding Voltage:	700V AC for 1 minute
Contact Resistance:	30mΩ max. at 10mA/20mV max.
Operating Temperature Range:	-55°C to +170°C
Mating Cycles:	10,000 insertions min.

**MATERIALS AND FINISH**

Housing:	Polyetherimide (PEI), glass-filled
Contacts:	Beryllium Copper (BeCu)
Plating:	Gold over Nickel

**FEATURES**

- 168 contact pins
- Card thickness 1.27mm
- 7 different positioning indicators
- Possible customer DIMM modules:  
Toshiba, NEC, OKI, Hitachi, Fujitsu, Siemens and Infineon

**PART NUMBER**

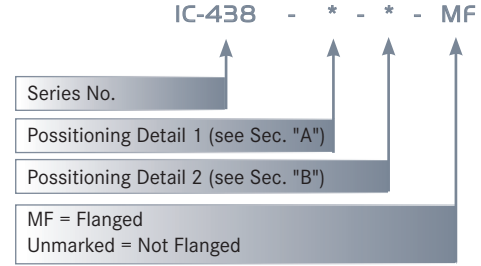

**OUTLINE SOCKET DIMENSIONS**

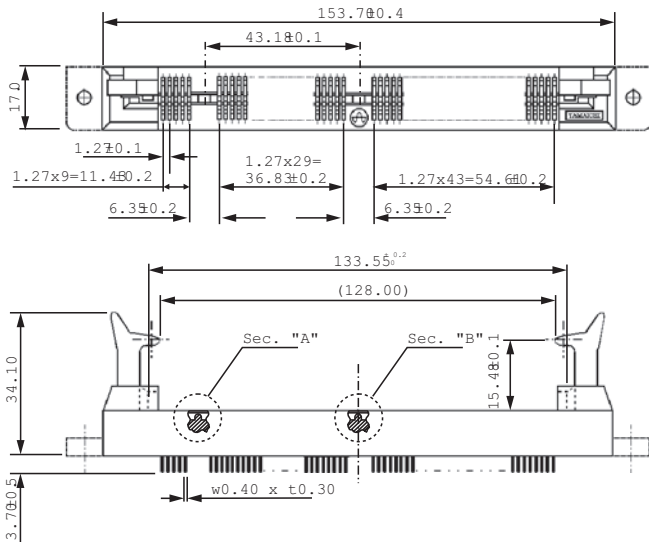

**RECOMMENDED PCB LAYOUT**

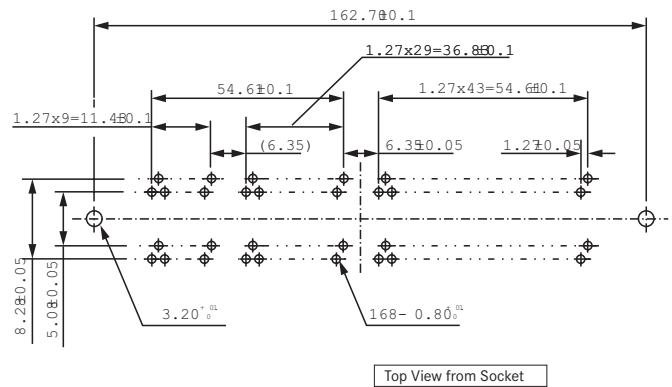

**POSITIONING PIN DETAILS**

Section "A" (DRAM Key Indicators)

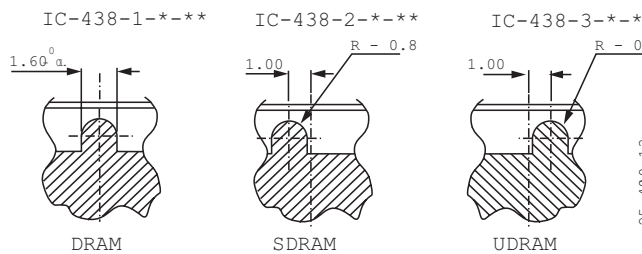

Section "B" (Voltage Key Indicators)

IC-438-\*1-\* IC-438-\*2-\* IC-438-\*3-\* IC-438-\*4-

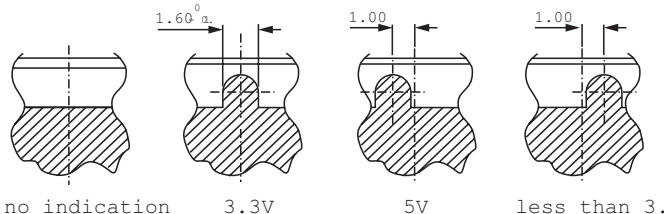

**MATCHING MODULE DIMENSIONS**

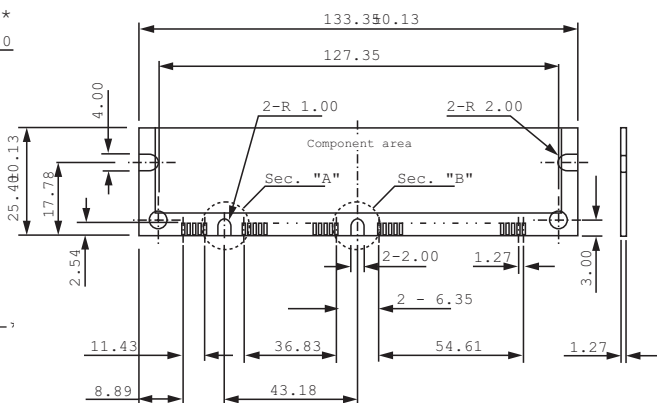

**SPECIFICATIONS**

Insulation Resistance:	1,000MΩ min. at 500V DC
Dielectric Withstanding Voltage:	700V AC for 1 minute
Contact Resistance:	30mΩ max. at 10mA/20mV max.
Operating Temperature Range:	-55°C to +170°C
Mating Cycles:	10,000 insertions

**MATERIALS AND FINISH**

Housing:	Polyetherimide (PEI), glass-filled
Contacts:	Beryllium Copper (BeCu)
Plating:	Gold over Nickel

**FEATURES**

- 184 and 240 contact pins
- Card thickness 1.27mm with 1.00mm pitch

**PART NUMBER**

IC-595 - \* - \* - MF - \*

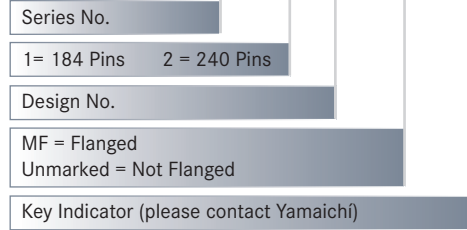

**OUTLINE SOCKET DIMENSIONS**

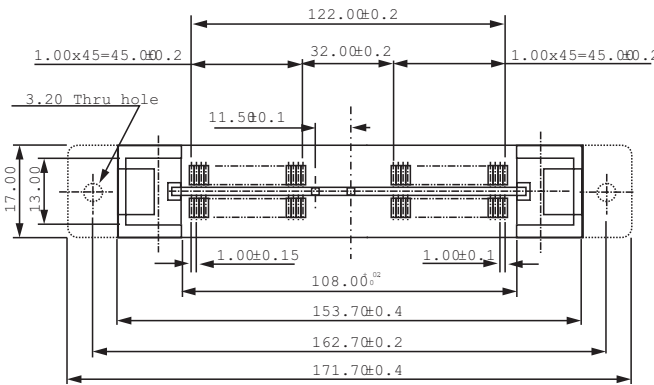

**RECOMMENDED PCB LAYOUT (IC-595-1 ONLY)**

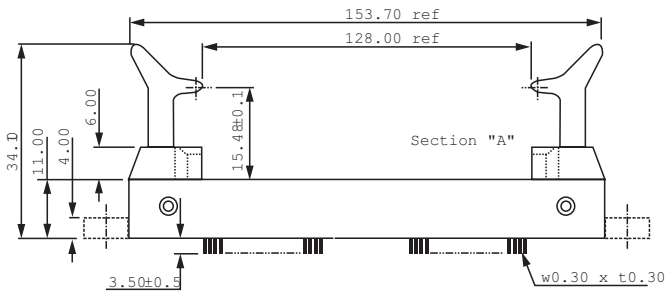
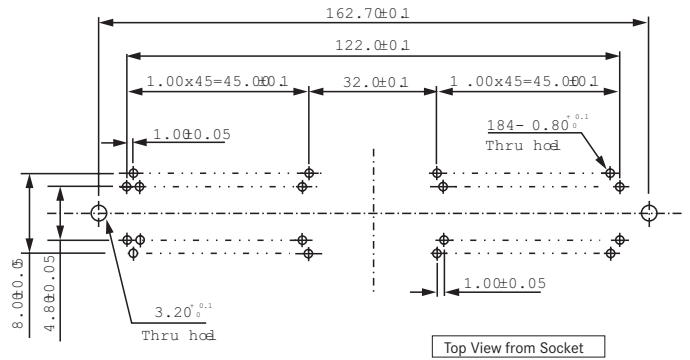

**MATCHING MODULE DIMENSIONS (IC-595-1 ONLY)**

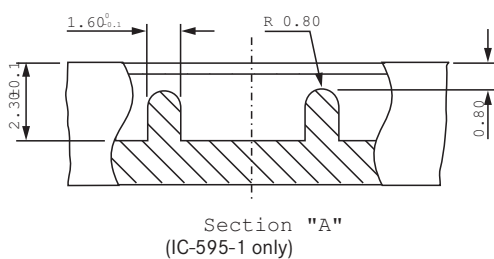
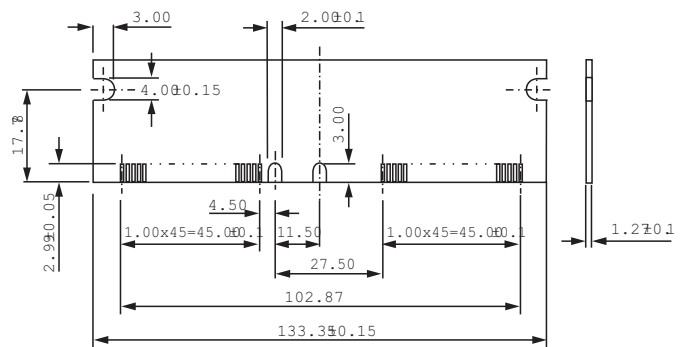

Section "A"  
(IC-595-1 only)

**SPECIFICATIONS**

Insulation Resistance:	1,000MΩ min. at 500V DC
Dielectric Withstanding Voltage:	700V AC for 1 minute
Contact Resistance:	30mΩ max. at 10mA/20mV max.
Operating Temperature Range:	-55°C to +170°C
Mating Cycles:	10,000 insertions min.

**MATERIALS AND FINISH**

Housing:	Polyetherimide (PEI), glass-filled
Contacts:	Beryllium Copper (BeCu)
Plating:	Gold over Nickel

**FEATURES**

- 184 contact pins with 1.27mm pitch
- Card thickness 1.27mm



**PART NUMBER**

IC-589 - 1 - MF

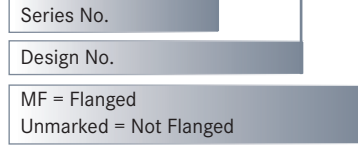

**OUTLINE SOCKET DIMENSIONS**

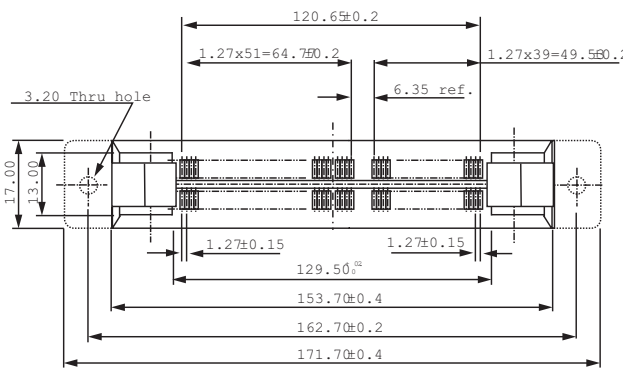

**RECOMMENDED PCB LAYOUT**

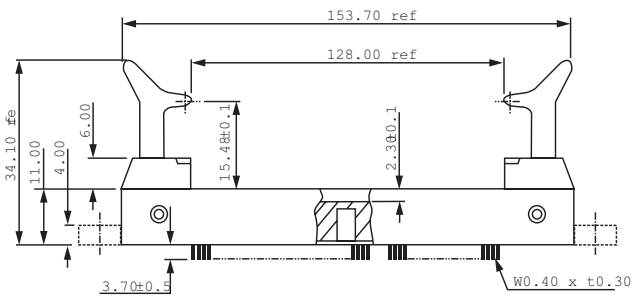
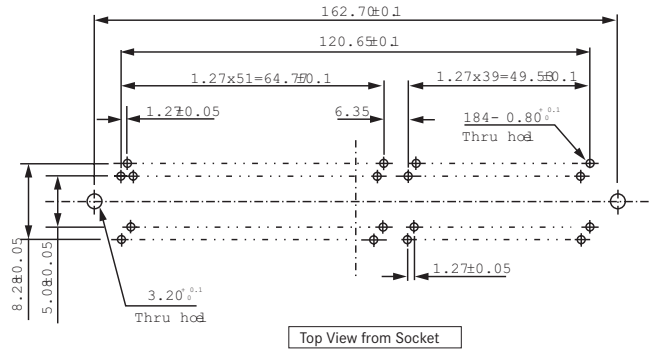

**MATCHING MODULE DIMENSIONS**

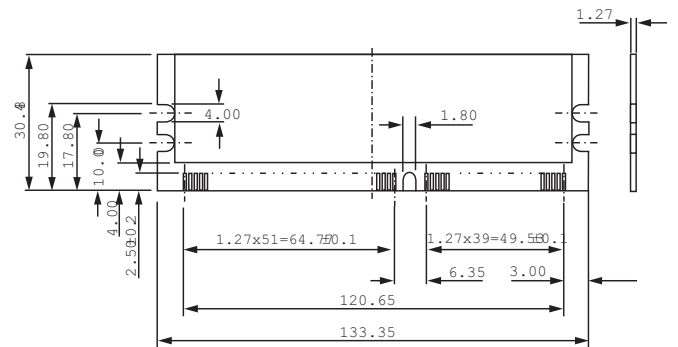

**SPECIFICATIONS**

Insulation Resistance:	1,000MΩ min. at 500V DC (IC657-1) 1,000MΩ min. at 100V DC (IC657-2 / 3)
Dielectric Withstanding Voltage:	700V AC for 1 minute (IC657-1) 100V AC for 1 minute (IC657-2 / 3)
Contact Resistance:	30mΩ max. at 10mA/20mV max.
Operating Temperature Range:	-55°C to +170°C
Mating Cycles:	10,000 insertions min.

**MATERIALS AND FINISH**

Housing:	Polyetherimide (PEI), glass-filled
Contacts:	Beryllium Copper (BeCu)
Plating:	Gold over Nickel



**PART NUMBER**

IC-657 - \* - \* MF

Series No. ↑

1 = 200 pins with 0.6mm Pitch  
2 = 172 pins with 0.5mm Pitch  
3 = 144 pins with 0.5mm Pitch

Design No. ↑

MF = Flanged  
Unmarked = Not Flanged

**FEATURES**

- 144 and 172 contact pins with 0.5mm pitch
- 200 contact pins with 0.6mm pitch

**OUTLINE SOCKET DIMENSIONS**

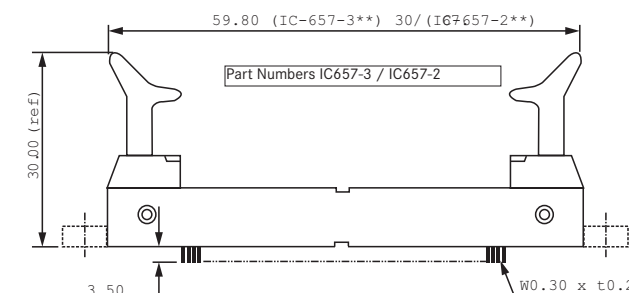
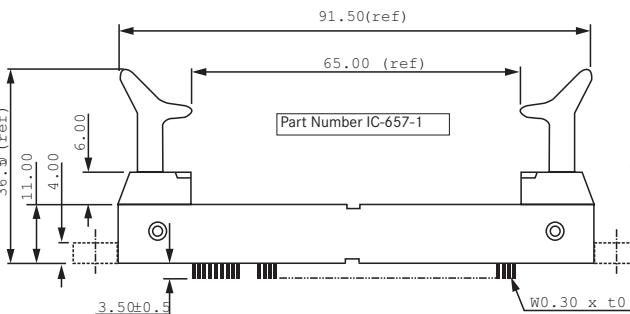
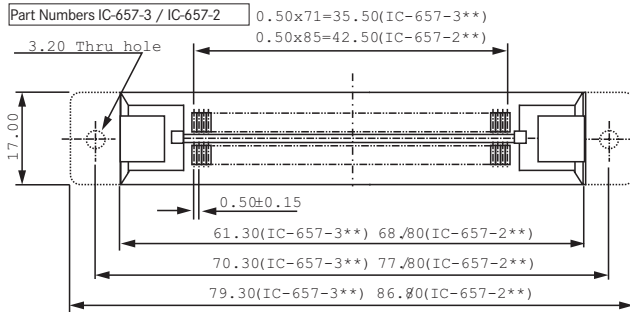
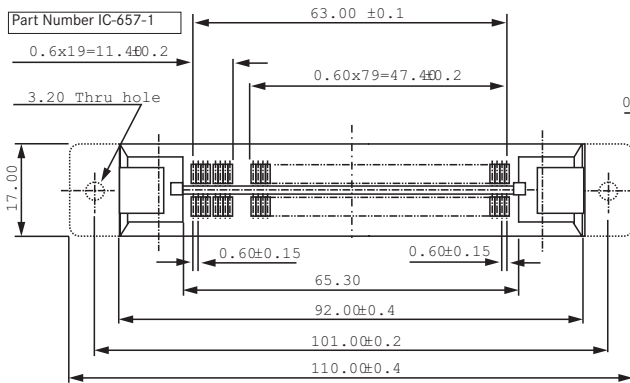

**RECOMMENDED PCB LAYOUT**

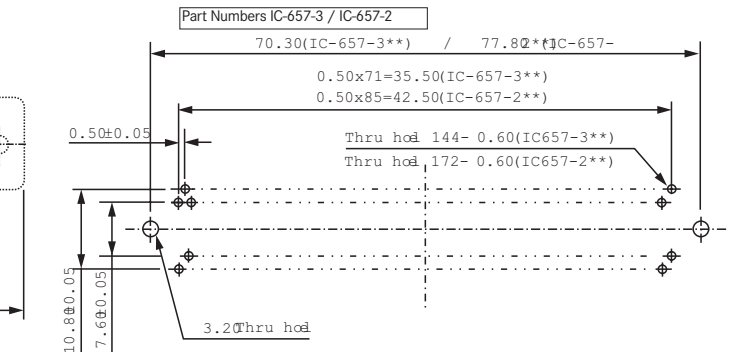
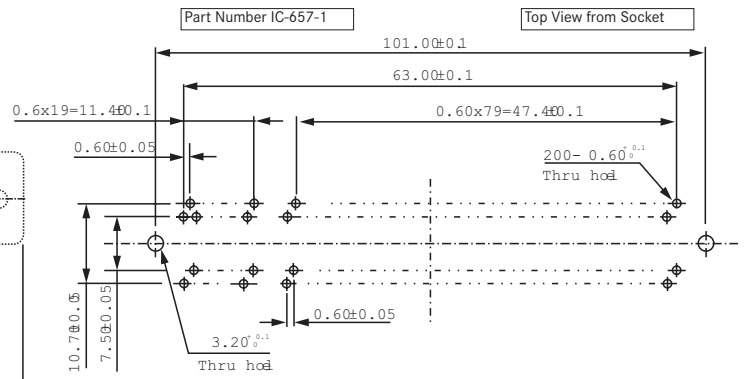

**MATCHING MODULE DIMENSIONS**

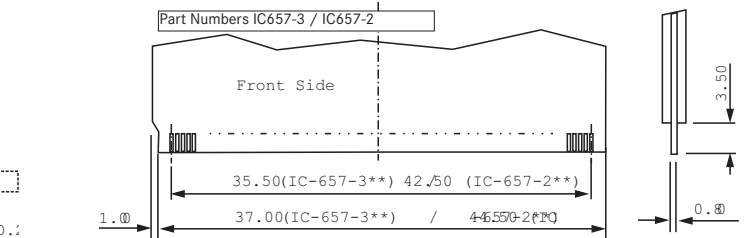
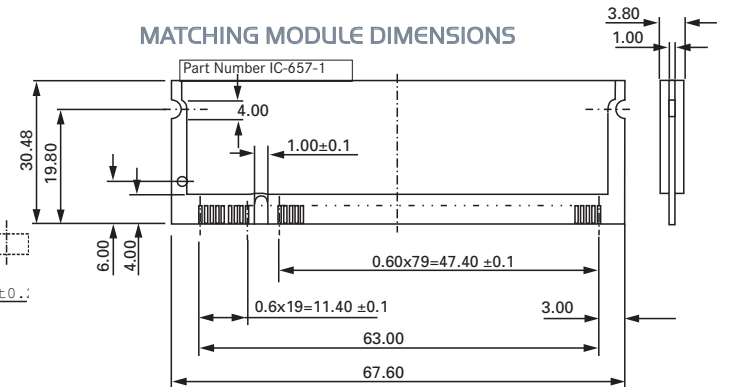

**SPECIFICATIONS**

Insulation Resistance:	1,000MΩ min. at 500V DC
Dielectric Withstanding Voltage:	700V AC for 1 minute
Contact Resistance:	30mΩ max. at 10mA/20mV max.
Current Rating:	1A max.
Operating Temperature Range:	-40°C to +150°C
Mating Cycles:	10,000 insertions min.

**MATERIALS AND FINISH**

Housing:	Polyetherimide (PEI), glass-filled Polyethersulphone (PES), glass-filled
Contacts:	Beryllium Copper (BeCu)
Plating:	Gold over Nickel

**FEATURES**

- Card thickness 1.27mm
- Kelvin type contact which utilizes both sides of the contact system
- Easy insertion and extraction by latch

**OUTLINE SOCKET DIMENSIONS**

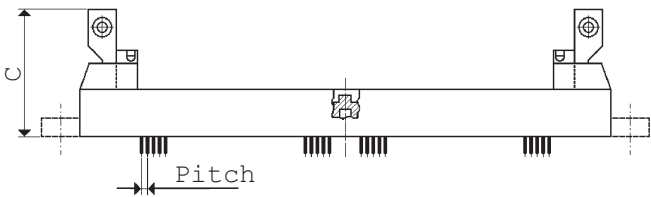
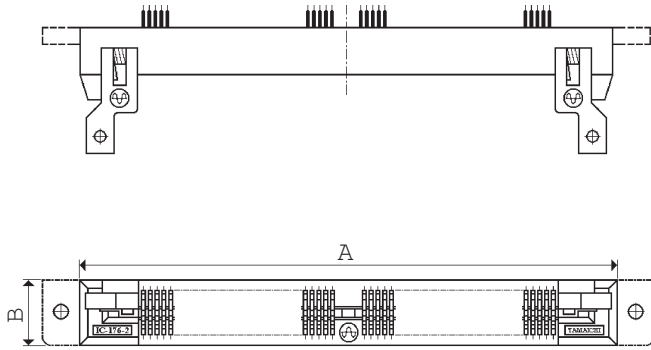

**PART NUMBER**

IC-176 - \* - MF

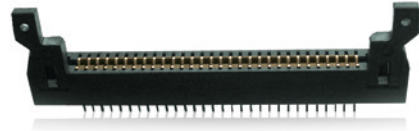
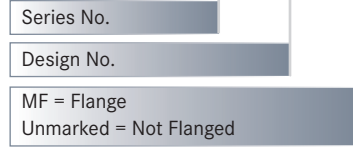

**RECOMMENDED PCB LAYOUT (IC-176-2-\*\*)**

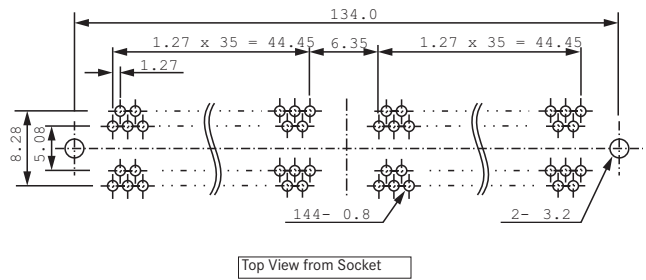

**MATCHING MODULE DIMENSIONS (IC-176-2-\*\*)**

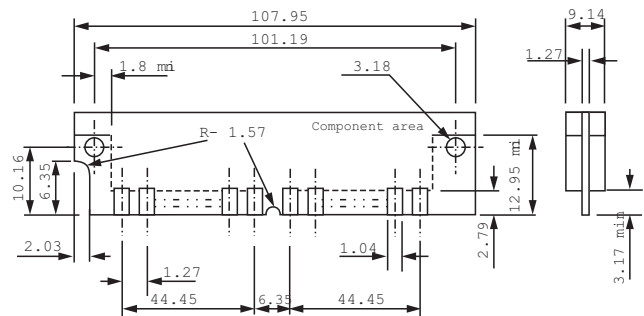

**1.27MM PITCH**

Part Number	Pin Count	A	B	C
IC-176-8-**	64	115.0	15	30
IC-176-2-**	72	125.0	15	30
IC-176-10-**	100	161.4	17	30

**2.54MM PITCH**

Part Number	Pin Count	A	B	C
IC-176-4-**	30	100.0	9	30
IC-176-6-**	35	115.0	9	30

All tables show only a selection of sockets available. For customised or other socket types. Please contact Yamaichi Electronics



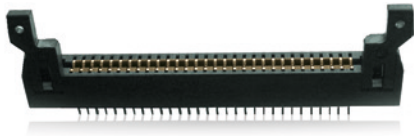

RECOMMENDED PCB LAYOUT (IC-176-4-\*\*)

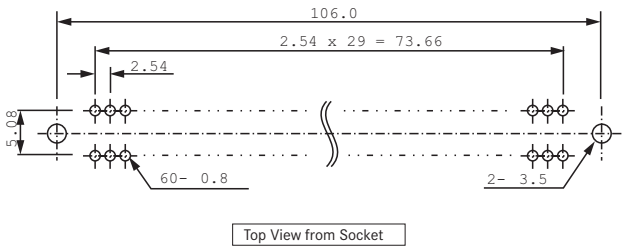

MATCHING MODULE DIMENSIONS (IC-176-4-\*\*)

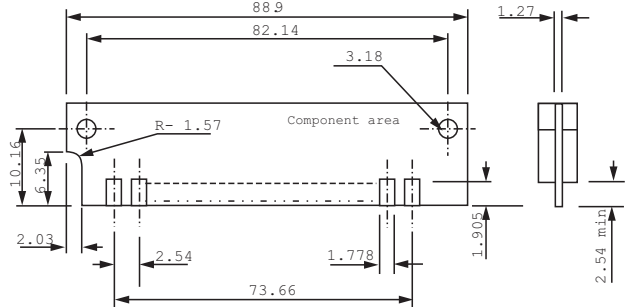

RECOMMENDED PCB LAYOUT (IC-176-6-\*\*)

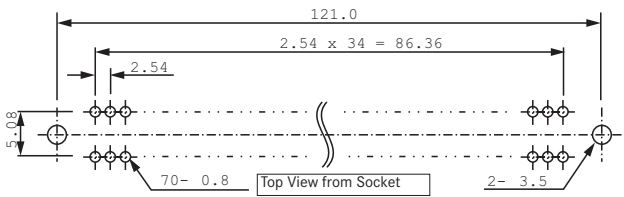

MATCHING MODULE DIMENSIONS (IC-176-6-\*\*)

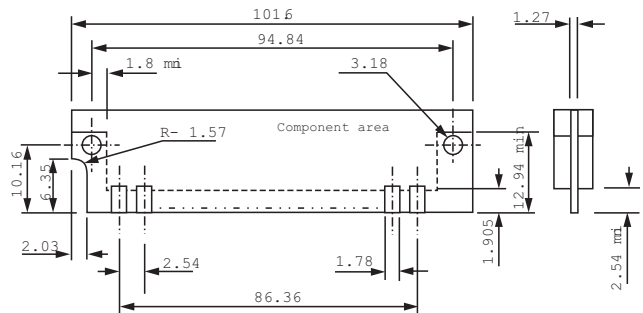

RECOMMENDED PCB LAYOUT (IC-176-8-\*\*)

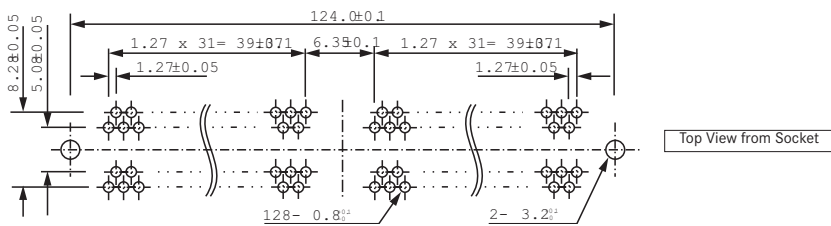

RECOMMENDED PCB LAYOUT (IC-176-10-\*\*)

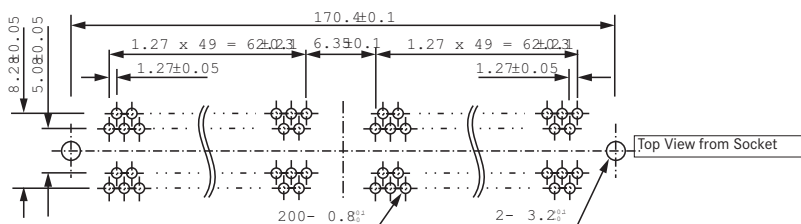

**SPECIFICATIONS**

Insulation Resistance:	1,000MΩ min. at 500V DC
Dielectric Withstanding Voltage:	1.000V AC for 1 minute
Contact Resistance:	10mΩ max. at 10mA/20mV max.
Current Rating:	3A
Operating Temperature Range:	-40°C to +170°C
Mating Cycles:	500 (1.75mm max. PCB thickness)

**MATERIALS AND FINISH**

Housing:	Polyetherimide (PEI), glass-filled
Contacts:	Beryllium Copper (BeCu)
Plating:	Gold over Nickel
Terminals:	Solder Plating over Nickel

**FEATURES**

- Card thickness 1.6mm
- 2 terminal types available

**PART NUMBER**

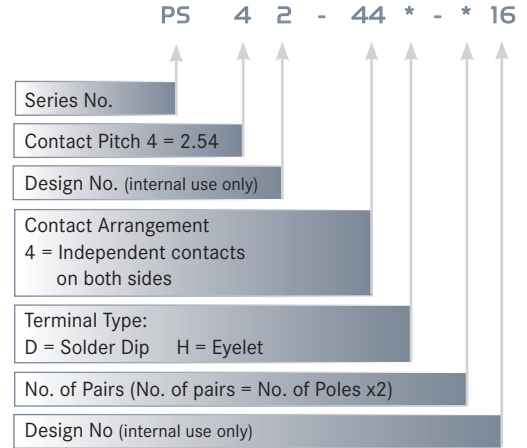

**OUTLINE SOCKET DIMENSIONS**

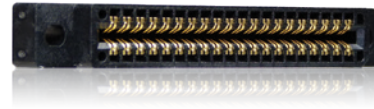
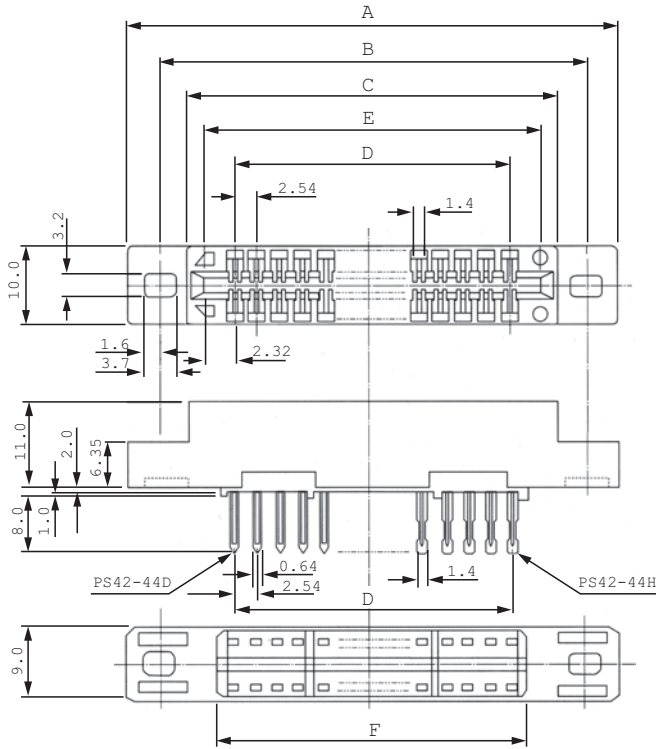

**CONTACT DETAIL**

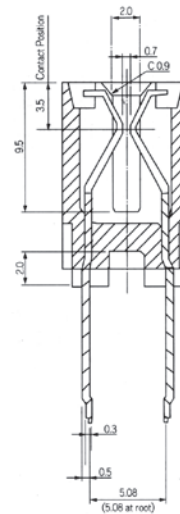

**MATCHING PCB DIMENSIONS**

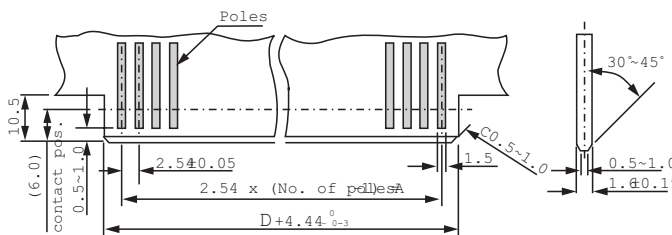

**RECOMMENDED PCB LAYOUT**

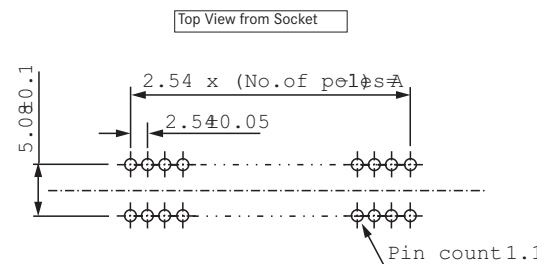

**2.54MM PITCH**

Part Number	Pin Count	A	B	C	D	E	F
PS42-44*-2016	40	71.50	64.50	57.30	48.26	52.90	54.40
PS42-44*-6016	120	173.10	160.10	158.90	149.86	154.50	156.00

Table show only a selection of sockets available. For customised or other socket types. Please contact Yamaichi Electronics

**SPECIFICATIONS**

Insulation Resistance:	1,000MΩ min. at 500V DC
Dielectric Withstanding Voltage:	1,000V AC for 1 minute
Contact Resistance:	10mΩ max. at 10mA/20mV max.
Current Rating:	3A
Operating Temperature Range:	-40°C to +170°C
Mating Cycles:	500 (1.75mm max. PCB thickness)

**MATERIALS AND FINISH**

Housing:	Polyetherimide (PEI), glass-filled
Contacts:	Beryllium Copper (BeCu)
Plating:	Gold over Nickel
Terminals:	Solder Plating over Nickel

**FEATURES**

- Card thickness 1.6mm
- 2 terminal types available

**OUTLINE SOCKET DIMENSIONS**

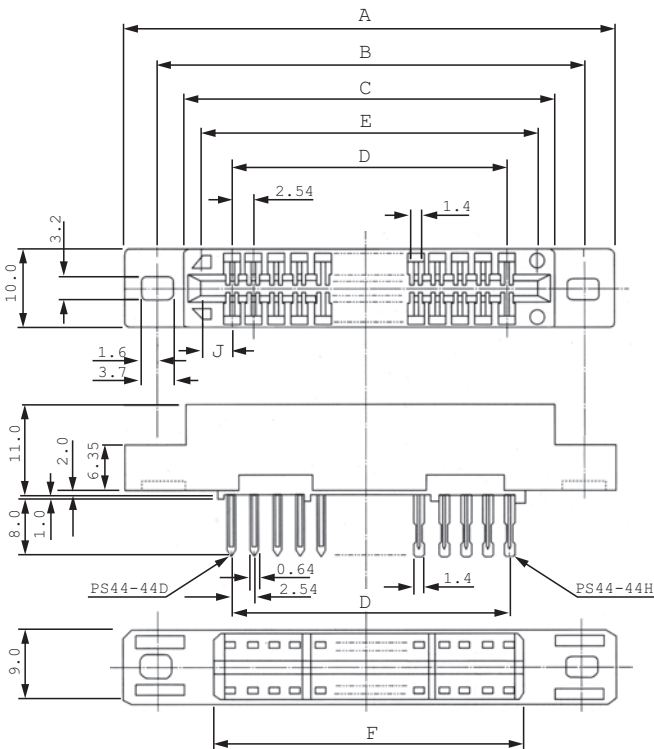

**MATCHING PCB DIMENSIONS**

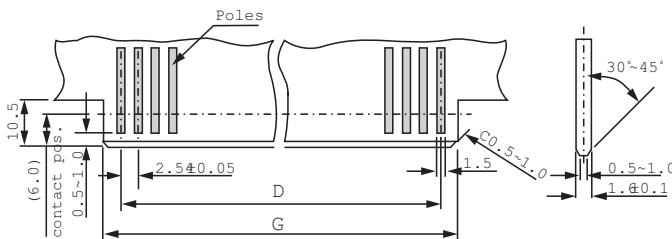

**2.54MM PITCH**

Part Number	Pin Count	A	B	C	D	E	F	G	H	J
PS44-44*-1411	28	56.77	50.17	42.16	33.02	38.00	39.37	37.8	49.67	2.4
PS44-44*-3011	60	97.41	90.81	82.80	73.66	78.64	80.01	78.44	90.31	2.4
PS44-44*-3611	72	112.65	106.05	98.04	88.90	93.88	95.25	93.66	105.55	2.4
PS44-44*-4311	86	130.43	123.43	115.82	106.68	111.66	113.03	111.46	123.33	2.4
PS44-44*-4411	88	132.97	126.37	118.36	109.22	114.20	115.57	114.00	125.87	2.4
PS44-44*-5011	100	148.21	141.61	133.60	124.46	129.44	130.81	129.24	141.11	2.4

Table show only a selection of sockets available. For customised or other socket types. Please contact Yamaichi Electronics

**PART NUMBER**

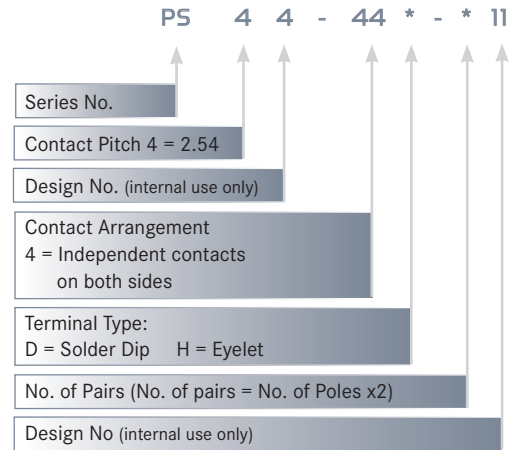

**CONTACT DETAIL**

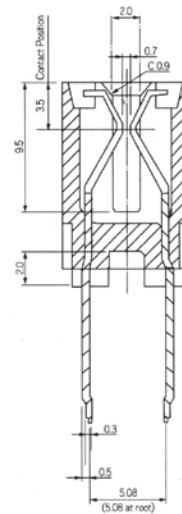

**RECOMMENDED PCB LAYOUT**

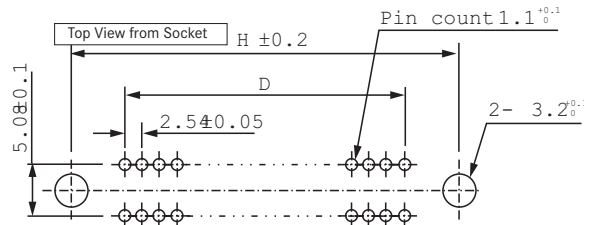

**SPECIFICATIONS**

Insulation Resistance:	1,000MΩ min. at 500V DC
Dielectric Withstanding Voltage:	1,000V AC for 1 minute
Contact Resistance:	10mΩ max. at 10mA/20mV max.
Current Rating:	3A
Operating Temperature Range:	-40°C to +170°C
Mating Cycles:	500 (1.75mm max. PCB thickness)

**MATERIALS AND FINISH**

Housing:	Polyetherimide (PEI), glass-filled
Contacts:	Beryllium Copper (BeCu)
Plating:	Gold over Nickel
Terminals:	Solder Plating over Nickel

**FEATURES**

- Card thickness 1.6mm
- 2 terminal types available

**PART NUMBER**

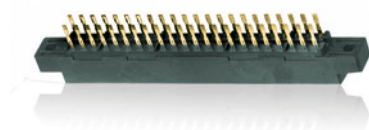
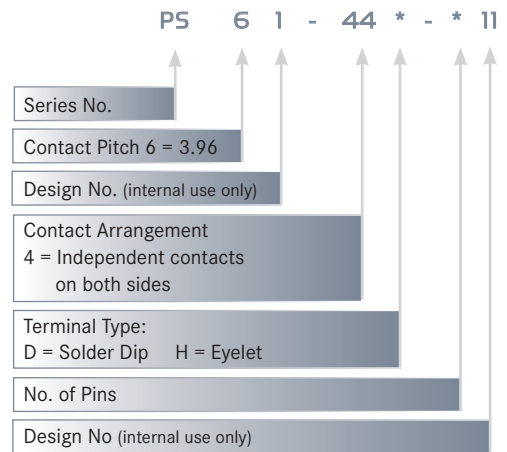

**OUTLINE SOCKET DIMENSIONS**

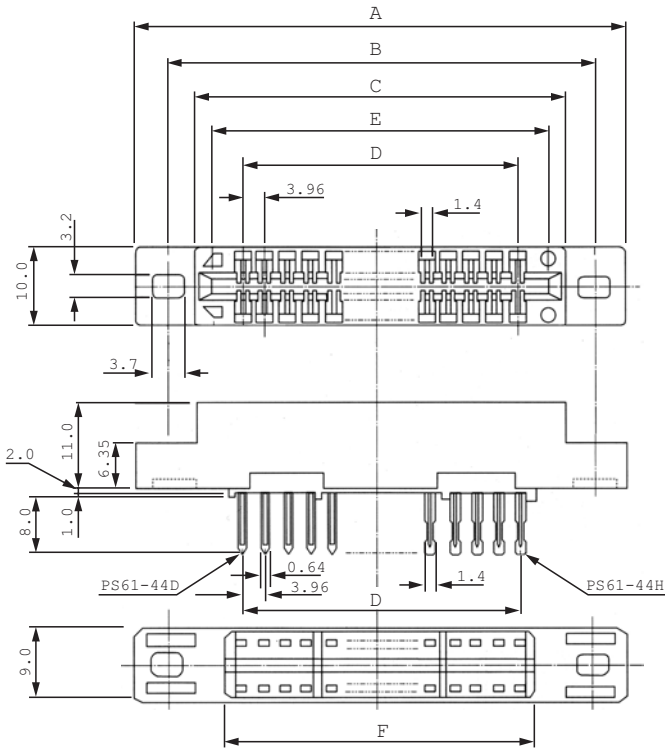

**CONTACT DETAIL**

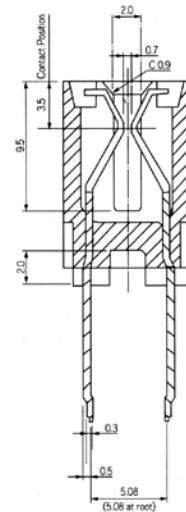

**MATCHING PCB DIMENSIONS**

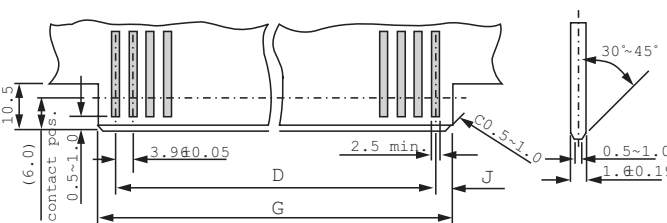

**RECOMMENDED PCB LAYOUT**

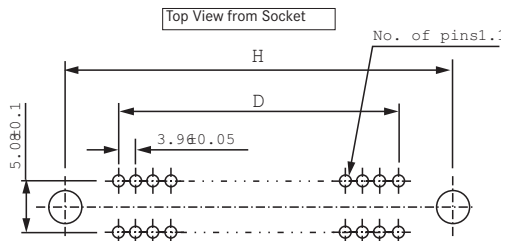

**3.96MM PITCH**

Part Number	Pin Count	A	B	C	D	E	F	G	H	J
PS61-44*-3611	36	94.59	86.51	79.35	67.32	75.49	72.75	75.29	86.51	1.1
PS61-44*-4411	44	110.45	102.36	95.20	83.16	91.34	88.59	91.14	102.36	1.3
PS61-44*-7211	72	165.91	157.84	150.67	138.60	146.81	144.07	146.61	157.84	4.1
PS61-44*-8611	86	193.65	185.57	178.41	166.32	174.55	171.81	174.35	185.57	4.2
PS61-44*-8811	88	197.61	189.58	182.37	170.28	178.51	175.77	178.31	189.53	4.2

Table show only a selection of sockets available. For customised or other socket types. Please contact Yamaichi Electronics

# GENERAL TERMS OF AGREEMENT

## 1. General

- 1.1 Our conditions of sale and delivery (in what follows "terms of business") apply exclusively to all of our business relationships with entrepreneurs, as understood in § 14 BGB – German Civil Code - (in what follows "purchasers"), as of 1st January 2011, whether entered into for the first time, ongoing or to be entered into in the future. They are also valid even in the event that when the respective business relationship is concluded they are not then referred to again.
- 1.2 Terms of our contractual partners that differ from our own terms of business will not be recognised unless we have expressly agreed to their validity in writing.

## 2. Offers, orders, conclusion of a contract

- 2.1 Our offers are in principle non-binding and subject to confirmation unless they are explicitly designated as binding offers. The sending of our price list(s) is not to be regarded as an offer. The technical information, details of use and product descriptions contained in our brochures and other sales documents contain no offer to sign a guarantee agreement as it is outlined in § 443 BGB\*\*.
- 2.2 Ordering a product and/or service includes the binding offer on the part of the purchaser to purchase that product or service. We are entitled to accept the contractual offer implicit in the order within two weeks of receiving the order. The acceptance of the offer can be made by us either in writing or by means of the delivery/execution to/for the purchaser of the product/service ordered. We reserve the right to refuse orders and to do so without written declaration or providing more detailed reasons for such decisions. In if doubt, no response from us after the expiry of the deadline for acceptance should be taken as rejection.
- 2.3 If the order is made electronically we will confirm receipt of the order immediately. The confirmation of receipt itself still does not constitute any binding acceptance of the order; however it can be conjoined with a declaration of acceptance on our part.
- 2.4 In the case of verbally agreed contracts the scope of service of our deliveries will be determined through our written affirmation of the contract.

## 3. Delivery

- 3.1 Partial deliveries or services rendered in part are permissible and oblige our contractual partner to pay the proportional price unless the partial delivery or service is unacceptable to them.
- 3.2 For supply contracts on demand the whole set of orders counts as having been ordered by the purchaser one calendar month after the expiry of the deadline agreed for the order or, if there is no agreed deadline, three calendar months after the contract is signed.
- 3.3 If the purchaser is entitled to the division of the on call contingents and does not conduct the division within one calendar month of the expiry of the respectively agreed order deadline or, if such a deadline has not been set, one month after requested by us, we may divide, deliver and charge for the complete set of orders at our discretion.
- 3.4 Our deliveries are made "ex works Munich" as long as nothing else has been explicitly agreed upon. In the case of a delivery "ex works" the seller's and purchaser's duties regarding the method of delivery are determined according to the International Commercial Terms (INCOTERMS® 2010) in their current amendment.
- 3.5 The delivery and service deadlines stated by us are non-binding and subject to confirmation; they can be affected by delay in supply or production, or disruptions to operations. In the case of subsequent contractual amendments or supplementations, the delivery deadlines and dates will begin anew or be postponed correspondingly, even if they had already been confirmed by us beforehand. This holds insofar as in each respective case no differing agreement has been reached with the purchaser.
- 3.6 Should we default on delivery for reasons for which we are responsible, our liability will be limited to the foreseeable and direct average damage.

## 4. Default on acceptance

- 4.1 Should the purchaser default on acceptance or violate other cooperation obligations we are authorised, regardless of our duties in accordance with clauses 3.2 and 3.3, to withdraw from the contract at our discretion and to demand the damages accruing to us through the default or violation, including additional expenses.
- 4.2 In the case of default on acceptance, the risk of accidental loss or accidental deterioration of the delivered object shall devolve onto the purchaser as of the moment at which they defaulted on acceptance.

## 5. Prices and payments

- 5.1 Our prices are to be understood as being principally in net cash in Euros, ex works/warehouse Munich, plus dispatch and packaging costs, insofar as nothing else is agreed in writing. Regulatory charges, customs duties and taxes are to be paid separately in the respective amounts applicable at the time of invoicing.
- 5.2 In the case of a single order with a net value of less than €100.00 we are entitled to add an additional small-order surcharge of €30.00 to our prices.
- 5.3 Our prices are valid for six weeks from the day the contract is signed. The agreed prices only apply to the respective completed order.
- 5.4 Price changes are admissible if there are more than six weeks between the signing of the contract and the agreed delivery date. If, after that period and until the completion of the delivery, the wages, material costs or cost prices (listed prices) rise in line with real market conditions or the exchange rates change, we will be entitled to raise the price appropriately, according to the increase in costs.
- 5.5 The first three deliveries will only be made if paid for in cash on delivery. For further follow-up deliveries our invoices are to be paid in full in net cash within 30 days of the date on which the invoice or an equivalent statement of payment is issued.
- 5.6 Payment deadlines are recognised as having been complied with if we have the amount at our disposal within the deadline. Our representatives and/or commissaries must only be paid by way of discharge if they provide evidence of a written authorisation of collection.
- 5.7 Should the purchaser default on their payment obligation, either in whole or in part, they must from this point onwards – notwithstanding our other further rights – pay default interest in the amount of 5% per year above the base interest rate set by the European Central Bank, insofar as we do not provide evidence of greater damages.
- 5.8 For each written warning regarding an invoice which is made after entering into default, we are entitled to demand a fixed processing fee of €5.00.
- 5.9 Offsetting or retention on the part of the purchaser is precluded unless the offsetting or retention claim is undisputed or established to be legally binding. We are entitled to avert the exercise of the right of retention by providing security, even without a guarantee.
- 5.10 If the purchaser ceases payments, has excessive debts, is subject to an application to open insolvency proceedings, or comes into default on the redemption of due drafts or cheques, our total claims will be due immediately. The same applies in the case of any other substantial decline in the purchaser's financial standing. In these cases we are entitled to demand sufficient security and to withdraw from the contract.

## 6. Retention of title

- 6.1 The goods remain our property until the fulfilment of all claims existing between ourselves and the purchaser (goods subject to retention of title), even if individual goods have already been paid for. A pledge or chattel mortgage of the goods subject to retention of title is not permissible.
- 6.2 In the case of the resale or passing on of goods subject to retention of title – as permitted within the framework of proper business operations – the purchaser proceeds to us, at that point in time and up until repayment of all claims due to us, all future claims accruing to them from the resale or passing on of the goods to their customers as security, without particular explanations being necessary at a later date. This also extends to outstanding balances, which arise within the framework of the existing current account relationships or with the termination of those kinds of relationships between the purchaser and their customers. If the goods subject to retention of title are resold or passed on together with other objects without a unit price having been agreed for the goods subject to retention of title, the purchaser cedes to us, with priority over any other claims, that part of the total asking price or the total price obtained by the passing on of the goods that corresponds to the price of the goods subject to retention of title invoiced by us. The purchaser is authorised to collect the assigned claims arising from the resale or passing on until this authorisation is revoked; they are however not entitled to use them in any other way e.g. by assignment. The purchaser must make the customer aware of the assignment on our request, as well as issue us with the documents necessary for asserting rights against their customers e.g. invoices, and provide us with all the necessary information. The purchaser shall bear all the costs of the collection and of any possible interventions.

Should the purchaser receive an exchange on the basis of the authorisation granted to them to collect the assigned claim, the property listed in these papers is transferred to us with the recognised right of security. The handing over of the objects of exchange will be replaced by the agreement that the purchaser will take charge of them for us and then immediately deliver them to us with endorsement. If the equivalent value of the claim assigned to us in cheques is paid to the purchaser or to one of their financial institutions, they are obligated to disclose receipt immediately and to then make the payment. Ownership of the cheques is transferred to us, according to our recognised rights, as soon as the purchaser receives them. The handing over of the papers will be replaced by the agreement that the purchaser will take charge of them for us and then immediately deliver them to us with endorsement.

- 6.3 If the purchaser processes the goods subject to retention of title, transform them or amalgamate them with other objects, this processing, transformation or amalgamation takes place on our behalf. We will immediately become the owner of the objects produced by means of the processing, transformation or amalgamation. Should this not be possible on legal grounds, we and the purchaser agree that we will be the owner of the new objects at every step of the processing, transformation or amalgamation. The purchaser will keep the new objects safe for us with due professional care and diligence. The objects resulting from the processing, transformation or amalgamation count as goods subject to retention of title. In the case of processing, transformation or amalgamation with other objects not belonging to us, we are entitled to co-ownership of the new objects in the ratio of the value of the processed, transformed or amalgamated goods subject to retention of title to the value of the new goods. In the case of sale or rental of the new objects, the purchaser herewith cedes to us their claim deriving from the sale or rental to their customers with all subsidiary rights as security, without further explanations being required at a later date. However, the transfer only applies in the amount that corresponds to the value of the processed, transformed or amalgamated goods subject to retention of title invoiced by us. The share of the claim assigned to us takes priority over the other claim.
- 6.4 Should the goods subject to retention of title be amalgamated with properties or movables by the purchaser, the purchaser also cedes to us the claim which is otherwise due to them as salary for the amalgamation with all subsidiary rights as security, without further particular explanations being required.
- 6.5 If the purchaser defaults on their payment obligation or on the redemption of due exchanges or cheques, either in whole or in part, or excessive debts or suspensions of payment arise, or an insolvency application is filed, we are authorised to immediately take back all goods still under retention of title. We can also make the further rights resulting from the retention of title immediately applicable. The same applies to any other substantial decline in the financial standing of the purchaser. The purchaser shall grant us or one of our commissaries access to their entire business premises during business hours. Demand for issuance or appropriation does not constitute withdrawal from the contract. We are entitled to utilise the goods subject to retention of title with due professional care and diligence and to pursue our own satisfaction, taking into account the open claims associated with the proceeds.
- 6.6 Should the value of the security exceed by more than 20% in total our claims against the purchaser resulting from the current business relationship, we are obliged on the request of the purchaser to release the security due to them at their discretion.

## 7. Claims of the purchaser in relation to defects

- 7.1 Only our description of the product or that of the manufacturer counts as an agreement on the quality of the goods. Public statements, promotion or advertising on the part of the manufacturer do not constitute contractual information regarding the quality of the goods.
- 7.2 The purchaser is obligated to fulfil their duties of inspection and notification of defects, as owed in accordance with § 377 HGB – German Code of Commercial Law. Goods delivered by us count as having been approved in conformity with the contract if we do not receive a written notification from the purchaser within 14 days of receipt of the goods, or at the latest 18 days after their delivery ex works, in which is concretely disclosed what complaints are being raised. Quantity differences of less than 5% in mass-produced articles do not constitute entitlement to a claim of defect. Insofar as nothing else is agreed in writing, our deliveries will each be performed to the standard existing at the time the order is made.
- 7.3 The claims are restricted at our discretion to removal of the defect or delivery of a defect-free item (a supplementary performance). In the case of failure regarding the supplementary performance, the purchaser has the right to depreciate or to withdraw from the contract at their discretion.
- 7.4 Further claims of the purchaser, in particular those following from damages consequential to a defect, are in principle precluded. This does not apply in the case of malice, gross negligence or breach of fundamental contractual obligations by us, or in the case of injury of life, body or health. The right of the purchaser to withdraw from the contract remains unaffected.
- 7.5 Liability for defects which can be attributed to unsuitable or inappropriate use, defective assembly – in particular under non-observance of the installation instructions – or start-up by the purchaser or a third party, natural wear and tear, defective or negligent handling, unsuitable operating components or replacement materials, or chemical, electrochemical, electrical, electronic or weather influences is excluded, insofar as the fault cannot be attributed to us.
- 7.6 The warranty period for material defects and defects of title is one year.
- 7.7 The purchaser will not receive guarantees in the legal sense from us. Manufacturers' warranties remain unaffected by this.

## 8. Liability

We will assume liability for claims for damages made by the purchaser as follows:

- a) Liability for personal injury is determined according to legal provisions.
- b) Liability for property damage is restricted to €250,000.00 per event and €500,000.00 in total.
- c) Liability for financial losses including direct losses and loss of profit is excluded.

The limitations on liability under b) and the disclaimer of liability under c) do not apply insofar as mandatory liability applies for damages to privately used objects in accordance with the law concerning product liability, or in cases of malice, gross negligence or breach of fundamental contractual obligations, or the lack of guaranteed characteristics for damages that are typical and reasonably foreseeable for this type of contract.

## 9. Other issues, place of fulfilment, place of jurisdiction

- 9.1 Ancillary verbal agreements only count as part of the contract if they are confirmed by us in writing.
- 9.2 Should a clause of these contractual conditions be completely or partially void and/or ineffective, the remaining conditions will not be affected. Rather, an ineffective condition should be replaced by another which is as near as possible to the economic intention.
- 9.3 If the purchaser is a businessman, Munich is the exclusive place of jurisdiction. The same place of jurisdiction applies if at the time of instigation of a lawsuit the purchaser has no general place of jurisdiction in the Federal Republic of Germany. The purchaser is, however, entitled to call upon any responsible court which can be deemed legally responsible.
- 9.4 The laws of the Federal Republic of Germany apply. The Hague Convention of 1st July 1964, concerning uniform laws regulating international purchases, and the treaty of the United Nations of 11th April 1980, concerning contracts of international sale of movable objects, do not apply.

## 1. Allgemeines

- 1.1. Unsere Verkaufs- und Lieferbedingungen (nachfolgend Geschäftsbedingungen) gelten ausschließlich für alle unsere Geschäftsbeziehungen, die wir ab dem 01.01.2011 erstmalig, laufend und zukünftig mit Unternehmern im Sinne von § 14 BGB (nachfolgend Besteller) eingehen und zwar auch dann, wenn bei dem jeweiligen Abschluss nicht nochmals auf sie hingewiesen wird.
- 1.2. Von unseren Geschäftsbedingungen abweichende Bedingungen unseres Vertragspartners erkennen wird nicht an, es sei denn, wir haben ihrer Geltung ausdrücklich schriftlich zugestimmt.

## 2. Angebote, Bestellungen, Vertragsabschluss

- 2.1. Unsere Angebote sind grundsätzlich unverbindlich und freibleibend, es sei denn, sie sind ausdrücklich als verbindliche Angebote gekennzeichnet. Die Zusendung unserer Preisliste(n) ist nicht als Angebot anzusehen. Die in unserer Werbung und/oder in unseren Prospekten und sonstigen Verkaufsunterlagen enthaltenen technischen Daten, Verwendungszweckangaben und Produktabbildungen beinhalten kein Angebot auf Abschluss eines Garantievertrages im Sinne von § 443 BGB.
- 2.2. Die Bestellung einer Ware und/oder Leistung beinhaltet das verbindliche Angebot des Bestellers, die Ware/Leistung erwerben zu wollen. Wir sind berechtigt, das in der Bestellung liegende Vertragsangebot innerhalb von zwei Wochen nach Bestelleingang anzunehmen. Die Angebotsannahme kann von uns schriftlich oder durch Auslieferung/Ausführung der bestellten Ware/Leistung an den Besteller erfolgen. Wir behalten uns vor, Bestellungen nicht anzunehmen, auch ohne schriftliche Äußerung oder nähere Begründung. Unser Schweigen nach Ablauf der Annahmefrist gilt im Zweifel als Ablehnung.
- 2.3. Erfolgt die Bestellung auf elektronischem Wege, werden wir den Zugang der Bestellung umgehend bestätigen. Die Zugangsbestätigung stellt noch keine verbindliche Annahme der Bestellung dar, jedoch kann die Zugangsbestätigung unsererseits mit der Annahmeerklärung verbunden werden.
- 2.4. Im Falle von mündlich vereinbarten Verträgen wird der Leistungsumfang unserer Lieferungen durch unsere schriftliche Vertragsbestätigung festgelegt.

## 3. Lieferung

- 3.1. Teillieferungen oder Teilleistungen sind zulässig und verpflichten unseren Vertragspartner zur Zahlung der anteiligen Vergütung, es sei denn, dass die Teillieferung oder -leistung für ihn unzumutbar wäre.
- 3.2. Bei Lieferaufträgen auf Abruf gilt die gesamte Bestellmenge einen Kalendermonat nach Ablauf der für den Abruf vereinbarten Frist oder mangels einer vereinbarten Frist drei Kalendermonate nach Vertragsschluss als vom Besteller abgerufen.
- 3.3. Ist der Besteller zur Einteilung von Abrufkontingenten berechtigt und nimmt er die Einteilung nicht innerhalb von einem Kalendermonat nach Ablauf der jeweils vereinbarten Abruffrist oder mangels einer solchen Frist einen Monat nach Aufforderung durch uns nicht vor, dürfen wir die bestellte Gesamtmenge nach unserer Wahl einteilen, liefern und berechnen.
- 3.4. Unsere Lieferungen erfolgen „ab Werk München“ (EXW), sofern nicht ausdrücklich etwas anderes vereinbart ist. Die Verkäufer- und Käuferpflichten der Art und Weise der Lieferung bestimmen sich im Falle einer Lieferung „ab Werk“ nach den International Commercial Terms (INCOTERMS® 2010) in ihrer derzeitigen Fassung.
- 3.5. Die von uns angegebenen Liefer- und Leistungsfristen sind unverbindlich und freibleibend; sie können sich durch Verzögerung bei der Zulieferung, Produktion oder Störungen im Betriebsablauf verändern. Bei nachträglichen Vertragsänderungen oder -ergänzungen beginnen die Lieferfristen und -termine, auch wenn sie von uns zuvor bereits bestätigt worden waren, neu zu laufen bzw. verschieben sich entsprechend, soweit im jeweiligen Einzelfall mit dem Besteller keine hiervon abweichende Vereinbarung getroffen worden ist.
- 3.6. Geraten wir aus Gründen, die wir zu vertreten haben, in Lieferverzug, so ist unsere Haftung auf den vorhersehbaren, unmittelbaren Durchschnittsschaden begrenzt.

## 4. Annahmeverzug

- 4.1. Kommt der Besteller in Annahmeverzug oder verletzt er sonstige Mitwirkungspflichten, so sind wir unbeschadet unserer Rechte nach Ziffer 3.2 und 3.3. berechtigt, nach unserer Wahl vom Vertrag zurückzutreten und den uns dadurch entstehenden Schaden, einschließlich der Mehraufwendungen, zu verlangen.
- 4.2. Im Falle des Annahmeverzugs geht auch die Gefahr des zufälligen Untergangs oder einer zufälligen Verschlechterung der gelieferten Sache in dem Zeitpunkt auf den Besteller über, in dem dieser in Annahmeverzug gerät.

## 5. Preise und Zahlungen

- 5.1. Unsere Preise verstehen sich grundsätzlich in EURO netto Kasse, ab Werk/Lager München, zzgl. Versand- und Verpackungskosten, sofern nichts anderes schriftlich vereinbart ist. Gesetzliche Abgaben, Zölle und Steuern sind in der jeweils bei Rechnungsstellung geltenden Höhe gesondert zu entrichten.
- 5.2. Im Falle einer Einzelbestellung im Netto-Warenwert von weniger als € 100,00 sind wir berechtigt, zusätzlich zu unseren Preisen einen Mindermengenzuschlag von € 30,00 zu berechnen.
- 5.3. Unsere Preise gelten vom Tage des Vertragsabschlusses an für sechs Wochen. Die vereinbarten Preise gelten nur für den jeweils geschlossenen Auftrag.
- 5.4. Preisänderungen sind zulässig, wenn zwischen Vertragsabschluss und vereinbartem Liefertermin mehr als sechs Wochen liegen. Erhöhen sich danach bis zur Fertigstellung der Lieferung die Löhne, Materialkosten oder die marktüblichen Einstandspreise (Listenpreise) oder verändern sich die Wechselkurse, so sind wir berechtigt, den Preis angemessen entsprechend den Kostensteigerungen zu erhöhen.
- 5.5. Die ersten drei Lieferungen erfolgen nur gegen Nachnahme. Darüber hinausgehende Folgelieferungen betreffend sind unsere Rechnungen binnen 30 Tagen netto Kasse nach Rechnungsstellung oder einer gleichwertigen Zahlungsaufstellung zur Zahlung ohne jeden Abzug fällig.
- 5.6. Zahlungsfristen gelten als eingehalten, wenn wir innerhalb der Frist über den Betrag verfügen können. An unsere Vertreter und/oder Beauftragte kann mit befreiender Wirkung nur bezahlt werden, wenn diese eine schriftliche Inkassovollmacht nachweisen.
- 5.7. Kommt der Besteller mit seiner Zahlungspflicht ganz oder teilweise in Verzug, so hat er – unbeschadet unserer sonstigen weiteren Rechte – ab diesem Zeitpunkt Verzugszinsen in Höhe von jährlich 5 Prozentpunkten über dem Basiszinssatz der Europäischen Zentralbank zu zahlen, soweit wir nicht einen höheren Schaden nachweisen.
- 5.8. Für jede schriftliche Mahnung einer Rechnung, die nach Verzugsseintritt erfolgt, sind wir berechtigt eine Bearbeitungspauschale von € 5,00 zu verlangen.
- 5.9. Eine Aufrechnung oder Zurückbehaltung des Bestellers ist ausgeschlossen, es sei denn die Aufrechnungs- oder Zurückbehaltungsforderung ist unbestritten oder rechtskräftig festgestellt. Wir sind berechtigt, die Ausübung des Zurückbehaltungsrechts durch Sicherheitsleistung – auch ohne Bürgschaft – abzuwenden.
- 5.10. Stellt der Besteller seine Zahlungen ein, liegt eine Überschuldung vor oder wird die Eröffnung eines Insolvenzverfahrens beantragt oder kommt der Besteller mit der Einlösung fälliger Wechsels oder Schecks in Verzug, so wird unsere Gesamtforderung sofort fällig. Dasselbe gilt bei einer sonstigen wesentlichen Verschlechterung der wirtschaftlichen Verhältnisse des Bestellers. Wir sind in diesen Fällen berechtigt, ausreichende Sicherheitsleistung zu verlangen und vom Vertrag zurückzutreten.

## 6. Eigentumsvorbehalt

- 6.1. Die Waren bleiben unser Eigentum bis zur Erfüllung sämtlicher uns gegen den Besteller zustehenden Ansprüche (Vorbehaltsware), auch wenn einzelne Ware bezahlt worden ist. Eine Verpfändung oder Sicherungsübereignung der Vorbehaltsware ist nicht zulässig.
- 6.2. Der Besteller tritt für den Fall der – im Rahmen des ordnungsgemäßen Geschäftsbetriebes zulässigen – Weiterveräußerung oder Weitergabe der Vorbehaltsware an uns schon jetzt bis zur Tilgung sämtlicher unserer Forderungen die ihm aus der Weiterveräußerung oder Weitergabe entstehenden künftigen Forderungen gegen seine Kunden sicherheitshalber ab, ohne dass es noch späterer besonderer Erklärungen bedarf; die Abtretung erstreckt sich auch auf Saldoforderungen, die sich im Rahmen bestehender Kontokorrentverhältnisse oder bei Beendigung derartiger Verhältnisse des Bestellers mit seinen Kunden ergeben. Wird die Vorbehaltsware zusammen mit anderen Gegenständen weiterveräußert oder weitergegeben, ohne dass für die Vorbehaltsware ein Einzelpreis vereinbart wurde, so tritt der Besteller an uns mit Vorrang vor den übrigen Forderungen denjenigen Teil der Gesamtforderung bzw. der für die Weitergabe erzielten Gesamtforderung ab, der dem von uns in Rechnung gestellten Wert der Vorbehaltsware entspricht. Bis auf Widerruf ist der Besteller zur Einziehung der abgetretenen Forderungen aus der Weiterveräußerung oder Weitergabe befugt; er ist jedoch nicht berechtigt, über sie in anderer Weise, z.B. durch Abtretung, zu verfügen.



Auf unser Verlangen hat der Besteller die Abtretung dem Kunden bekannt zu geben und uns die zur Geltendmachung der Rechte gegen den Kunden erforderlichen Unterlagen, z.B. Rechnungen, auszuhandigen und die erforderlichen Auskünfte zu erteilen. Alle Kosten der Einziehung und etwaiger Interventionen trägt der Besteller. Erhält der Besteller aufgrund der ihm erteilten Ermächtigung zur Einziehung der abgetretenen Forderung Wechsel, so geht das Eigentum an diesen Papieren mit dem verbrieften Recht sicherungshalber auf uns über. Die Übergabe des Wechsels wird durch die Vereinbarung ersetzt, dass der Besteller sie für uns in Verwahrung nimmt und sie dann unverzüglich indossiert an uns abliefern. Für den Fall, dass der Gegenwert der an uns abgetretenen Forderung in Schecks bei dem Besteller oder bei einem Geldinstitut des Bestellers eingehen sollte, ist dieser zur unverzüglichen Meldung der Eingänge und zur Abführung verpflichtet. Das Eigentum an den Schecks geht mit dem verbrieften Recht auf uns über, sobald sie der Besteller erhält. Die Übergabe der Papiere wird durch die Vereinbarung ersetzt, dass der Besteller sie für uns in Verwahrung nimmt und sie dann unverzüglich indossiert an uns abliefern.

- 6.3. Verarbeitet der Besteller die Vorbehaltsware, bildet er sie um oder verbindet er sie mit anderen Gegenständen, so erfolgt die Verarbeitung, Umbildung oder Verbindung für uns. Wir werden unmittelbar Eigentümer der durch die Verarbeitung, Umbildung oder Verbindung hergestellten Sache. Sollte dies aus rechtlichen Gründen nicht möglich sein, so sind der Besteller und wir uns darüber einig, dass wir in jedem Zeitpunkt der Verarbeitung, Umbildung oder Verbindung Eigentümer der neuen Sache werden. Der Besteller verwahrt für uns die neue Sache mit der Sorgfalt eines ordentlichen Kaufmanns. Die durch Verarbeitung, Umbildung oder Verbindung entstandene Sache gilt als Vorbehaltsware. Bei Verarbeitung, Umbildung oder Verbindung mit anderen, nicht uns gehörenden Gegenständen, steht uns Miteigentum an der neuen Sache in Höhe des Anteils zu, der sich aus dem Verhältnis des Wertes der verarbeiteten, umgebildeten oder verbundenen Vorbehaltsware zum Wert der neuen Sache ergibt. Für den Fall der Veräußerung oder Vermietung der neuen Sache tritt der Besteller an uns hiermit seinen Anspruch aus der Veräußerung oder Vermietung gegen seinen Kunden mit allen Nebenrechten sicherungshalber ab, ohne dass es noch späterer weiterer Erklärungen bedarf. Die Abtretung gilt jedoch nur in Höhe des Betrages, der dem von uns in Rechnung gestellten Wert der verarbeiteten, umgebildeten oder verbundenen Vorbehaltsware entspricht. Der an uns abgetretene Forderungsanteil hat den Vorrang vor der übrigen Forderung.
- 6.4. Wird die Vorbehaltsware vom Besteller mit Grundstücken oder beweglichen Sachen verbunden, so tritt der Besteller auch seine Forderung, die ihm als Vergütung für die Verbindung zusteht, mit allen Nebenrechten sicherungshalber an uns ab, ohne dass es weiterer besonderer Erklärungen bedarf.
- 6.5. Kommt der Besteller mit seiner Zahlungspflicht oder der Einlösung fälliger Wechsel oder Schecks ganz oder teilweise in Verzug, liegt eine Überschuldung oder Zahlungseinstellung vor oder ist ein Insolvenzantrag gestellt, so sind wir berechtigt, sämtliche noch unter Eigentumsvorbehalt stehenden Waren sofort an uns zu nehmen; ebenso können wir die weiteren Rechte aus dem Eigentumsvorbehalt sofort geltend machen. Dasselbe gilt bei einer sonstigen wesentlichen Verschlechterung der wirtschaftlichen Verhältnisse des Bestellers. Der Besteller gewährt uns bzw. einem von uns Beauftragten während der Geschäftsstunden Zutritt zu seinen sämtlichen Geschäftsräumen. Das Verlangen der Herausgabe oder die Inbesitznahme stellt keinen Rücktritt vom Vertrag dar. Wir sind berechtigt, die Vorbehaltsware mit der Sorgfalt eines ordentlichen Kaufmanns zu verwerten und uns unter Anrechnung auf die offenen Ansprüche aus deren Erlös zu befriedigen.
- 6.6. Übersteigt der Wert der Sicherung unsere Ansprüche gegen den Besteller aus der laufenden Geschäftsbeziehung insgesamt um mehr als 20 %, so sind wir auf Verlangen des Bestellers verpflichtet, ihm zustehende Sicherungen nach seiner Wahl freizugeben.

## **7. Ansprüche des Bestellers bei Mängeln**

- 7.1. Als Beschaffenheit der Ware gilt grundsätzlich nur unsere oder die Produktbeschreibung des Herstellers vereinbart. Öffentliche Äußerungen, Anpreisungen oder Werbung des Herstellers stellen daneben keine vertragsgemäße Beschaffenheitsangabe der Ware dar.
- 7.2. Der Besteller ist verpflichtet, seinen nach § 377 HGB geschuldeten Untersuchungs- und Rügepflichten nachzukommen. Von uns gelieferte Ware gilt als vertragsgerecht genehmigt, wenn wir nicht binnen 14 Tagen nach Erhalt der Ware, spätestens jedoch 18 Tagen nach deren Auslieferung ab Werk, eine schriftliche Anzeige des Bestellers erhalten, in der konkret mitgeteilt wird, welche Rügen erhoben werden. Mengendifferenzen bei Massenartikeln von weniger als 5% berechtigen nicht zur Mängelrüge. Sofern nichts anderes schriftlich vereinbart ist, werden unsere Lieferungen jeweils in dem bei Bestellung bestehenden Standard vorgenommen.
- 7.3. Die Ansprüche sind nach unserer Wahl auf Beseitigung des Mangels oder Lieferung einer mangelfreien Sache (Nacherfüllung) beschränkt. Bei Fehlschlägen der Nacherfüllung hat der Besteller das Recht, nach seiner Wahl zu mindern oder vom Vertrag zurückzutreten.
- 7.4. Weitergehende Ansprüche des Bestellers, insbesondere wegen Mangelfolgeschäden sind grundsätzlich ausgeschlossen. Dies gilt nicht bei Vorsatz, grober Fahrlässigkeit oder Verletzung wesentlicher Vertragspflichten durch uns sowie im Fall der Verletzung des Lebens, des Körpers oder der Gesundheit. Das Recht des Bestellers zum Rücktritt vom Vertrag bleibt unberührt.
- 7.5. Eine Haftung für Mängel, die durch ungeeignete oder unsachgemäße Verwendung, fehlerhafte Montage – insbesondere unter Nichtbeachtung der Installationsanweisung – bzw. Inbetriebsetzung durch den Besteller oder Dritte, natürliche Abnutzung, fehlerhafte oder nachlässige Behandlung, ungeeignete Betriebsmittel, Austauschwerkstoffe, chemische, elektrochemische, elektrische, elektronische oder Witterungseinflüsse zurückgehen, ist ausgeschlossen, sofern sie nicht auf unser Verschulden zurückzuführen sind.
- 7.6. Die Gewährleistungsfrist für Sach- und Rechtsmängel beträgt 1 Jahr.
- 7.7. Garantien im Rechtssinne erhält der Besteller von uns nicht. Herstellergarantien bleiben hiervon unberührt.

## **8. Haftung**

Wir haften für Schadenersatzansprüche des Bestellers wie folgt:

- a) Die Haftung für Personenschäden richtet sich nach den gesetzlichen Bestimmungen.
- b) Die Haftung für Sachschäden ist auf € 250.000,00 je Schadenereignis und € 500.000,00 insgesamt beschränkt.
- c) Die Haftung für Vermögensschäden einschließlich mittelbarer Schäden und entgangenen Gewinn ist ausgeschlossen.

Die Haftungsbeschränkungen unter b) und der Haftungsausschluss unter c) gelten nicht, soweit bei Schäden an privat genutzten Sachen nach dem Produkthaftungsgesetz oder in Fällen des Vorsatzes oder der groben Fahrlässigkeit oder der Verletzung wesentlicher Vertragspflichten oder des Fehlens zugesicherter Eigenschaften für vertragstypisch vorhersehbare Schäden zwingend gehaftet wird.

## **9. Sonstiges, Erfüllungsort, Gerichtsstand**

- 9.1. Mündliche Nebenabreden gelten nur dann als Vertragsbestandteil, wenn sie durch uns schriftlich bestätigt werden.
- 9.2. Sollte eine Klausel dieser Vertragsbedingungen ganz oder teilweise nichtig und/oder unwirksam sein, so werden die übrigen Bestimmungen hiervon nicht berührt. Eine unwirksame Bestimmung soll vielmehr durch eine ersetzt werden, die dem wirtschaftlich Gewollten am nächsten kommt.
- 9.3. Ist der Besteller Kaufmann, so ist München ausschließlicher Gerichtsstand. Der gleiche Gerichtsstand gilt, wenn der Besteller im Zeitpunkt der Einleitung eines gerichtlichen Verfahrens keinen allgemeinen Gerichtsstand in der Bundesrepublik Deutschland hat. Der Besteller ist jedoch berechtigt, jedes gesetzlich zuständige Gericht anzurufen.
- 9.4. Es gilt das Recht der Bundesrepublik Deutschland. Die Haager Konventionen vom 01.07.1964 betreffend einheitlicher Gesetze über den internationalen Kauf und das Übereinkommen der Vereinten Nationen vom 11.04.1980 über Verträge über den internationalen Kauf beweglicher Sachen finden keine Anwendung.

## AUSTRIA / EASTERN EUROPE

CODICO GmbH & Co. KG  
Zwingenstrasse 6 - 8  
2380 Perchtoldsdorf  
Austria

Contact: Mr. Christian Sichtar

Tel.: +43 186 305 0  
Fax: +43 186 305 5000  
e-mail: office@codico.com  
Internet: www.codico.com

## FINLAND

Yleiselektroniikka OY  
Po Box 73  
Luomannotko 6  
02201 Espoo  
Finland

Contact: Mr. Kai Nurmenniemi

Tel.: +358 10 2891 200  
Fax: +358 10 2891 270  
e-mail: kai.nurmenniemi@yeint.fi  
Internet: www.yeint.fi

## ISRAEL

Teder Electro Mechanical Engineering  
14 Atir Yeda st.  
Kfar-Saba 4464323  
Israel

Contact: Mr. Gadi Feit

Tel.: +972 73 2331200  
Fax: +972 73 2331233  
e-mail: sales@teder.com  
Internet: www.teder.com

## PORTUGAL

Sagitrón S.A.  
Lisbon  
Portugal

Tel.: +351 218 2886 14  
Fax: +351 218 2886 14  
e-mail: portugal@sagitrón.com  
Internet: www.sagitrón.com

## UNITED KINGDOM

Cyntech Components Ltd.  
Unit 29, Chancerygate Business Park  
Goulds Close, Denbigh West,  
Milton Keynes MK1 1EQ  
UK

Contact: Mr. Ian Mort

Tel.: +44 (0)1908 37 39 27  
Fax: +44 (0)1908 36 53 05  
e-mail: sales@cyntech.co.uk  
Internet: www.cyntech.co.uk

## BENELUX

Logic Technology B.V.  
John F. Kennedylaan 18  
5981 XC Panningen  
The Netherlands

Contact: Mr. René Janssen or  
Mr. André de Ceuninck

Tel.: +31 77 307 8438  
Fax: +31 77 307 8439  
e-mail: info@logic.nl  
Internet: www.logic.nl/yamaichi

## FRANCE

Manudax - France  
ZA les Petites Haies  
28, rue de Valenton  
BP302  
94709 Maisons-Alfort Cedex  
France

Contact: Mr. Philippe Matoulet or  
Mr. Christophe Lazerges

Tel.: +33 1 41 789444  
Fax: +33 1 48 994186  
e-mail: manudax@manudax.fr  
Internet: www.manudax.fr

## RUSSIA

YE International  
Obukhovskoy Oborony, 70, bld. 3A  
St. Petersburg, 192029  
Russia

Contact: Mr. Alexander Muraviev

Tel.: +7 812 313 34 40 ext.613  
Fax: +7 812 313 34 41  
e-Mail: alexander.muraviev@yeint.ru  
Internet: www.yeint.ru

## SWEDEN

Nanomil AB  
Vendevägen 90  
SE-182 32 Danderyd  
Sweden

Contact: Mr. Christian Rassmussen

Tel.: +46 8 684 051 42  
Fax: +46 739 013 742  
e-Mail: christian@nanomil.se  
Internet: www.nanomil.se

## DENMARK

Cabcon A/S  
Stamholmen 193 A  
2650 Hvidovre,  
Denmark

Contact: Mr. Brian Dehlisen or  
Mr. Flemming Schandorph

Tel.: +45 38 76 03 15  
Fax: +45 38 76 03 20  
e-mail: fs@cabcon.dk  
internet: www.cabcon.dk

## GERMANY

GLYN GmbH & Co. KG  
Am Wörtzgarten 8  
65510 Idstein / Taunus  
Germany

Contact: Mr. Heiko Keller

Tel.: +49 (0)6126 590342  
Fax: +49 (0)6126 590132  
e-mail: heiko.keller@glyn.de  
Internet: www.glyn.de

## SPAIN

Sagitrón S.A.  
General de Importaciones Electronicas  
C/Monton de Trigo 2,  
esquina Avda. de la Industria  
28760 Tres Cantos - Madrid  
Spain

Contact: Sig. Angel Zamora or  
Mr. Juan Escalonilla

Tel.: +34 91 806 38 00  
Fax: +34 91 806 38 05  
e-mail: sagitrón@sagitrón.com  
Internet: www.sagitrón.com

## SWITZERLAND

Sicovend AG  
Alte Poststrasse 1  
8310 Kempthal  
Switzerland

Contact: Mr. Othmar Stocker

Tel.: +41 52 354 80 24  
Fax: +41 52 354 80 00  
e-mail: othmar.stocker@sicovend.ch  
Internet: www.sicovend.ch

The technical data and specifications of the products shown in this catalogue are for reference only, and apply to products available at the time of catalogue printing in Sept. 2016. Product modification often involves changes to technical data and size, and it is therefore recommended that the buyer request the latest technical data and specifications before placing a purchasing contract.

Future updates to this printed catalogue can be found at  
<http://www.yamaichi.de/downloads/product-catalogues.html>

Technische Daten und Maßangaben der im Katalog aufgeführten Produkte beziehen sich auf Referenzprodukte aus dem Produktsortiment bei Erscheinen des Katalogs im Sept. 2016. Produktänderungen, insbesondere aufgrund technischer Weiterentwicklung, bedingen regelmäßig veränderte technische Daten und Maße. Dem Besteller wird daher dringend empfohlen, vor Vertragsabschluss technische Daten und Maßangaben gesondert nachzufragen.

Zukünftige Updates dieses gedruckten Katalogs finden Sie auf  
<http://www.yamaichi.de/de/downloads/produktkataloge.html>



# TEST SOLUTIONS

## FULL PRODUCT LINE

Version September 2019

TECHNICAL DATA ARE SUBJECT TO ALTERATION WITHOUT PRIOR NOTICE

### **YAMAICHI ELECTRONICS**

Deutschland GmbH  
Concor Park  
Bahnhofstraße 20  
85609 Aschheim-Dornach  
Germany

**Phone** +49 (0)89 45109-0  
**Fax** +49 (0)89 45109-110  
**E-Mail** [sales@yamaichi.de](mailto:sales@yamaichi.de)  
**Web** [www.yamaichi.de](http://www.yamaichi.de)

### **YAMAICHI ELECTRONICS**

Italia s.r.l.  
Centro Direzionale Colleoni  
Via Colleoni, 1  
Palazzo Taurus Ing. 1  
20864 Agrate Brianza (MB)  
Italy

**Phone** +39 039 6881-185  
**Fax** +39 039 6892-150  
**E-Mail** [sales@yamaichi.it](mailto:sales@yamaichi.it)  
**Web** [www.yamaichi.it](http://www.yamaichi.it)

### **YAMAICHI ELECTRONICS**

GB Ltd.  
6 The Clockhouse  
Stratton Park  
Micheldever  
Hampshire SO21 3DP  
Great Britain

**Phone** +44 (0)7808 493377  
**Fax** +44 (0)1962 774902  
**E-Mail** [sales@yamaichi.co.uk](mailto:sales@yamaichi.co.uk)  
**Web** [www.yamaichi.co.uk](http://www.yamaichi.co.uk)

# Mouser Electronics

Authorized Distributor

Click to View Pricing, Inventory, Delivery & Lifecycle Information:

[Yamaichi Electronics:](#)

[IC37NRB-2406-G4](#)