

**Key Features****Type TLR Series**

Up to 3 Watt  
at 80°C

Supplied on  
Tape

Ideal for  
Current  
Detection

12:06, 20:10  
and 25:12  
Packages  
Available

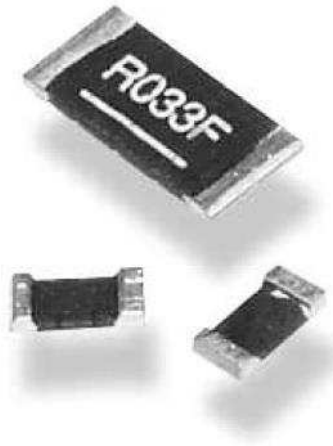

TE Connectivity (TE) is pleased to offer this unique High Power, metal chip resistor for current sensing positions. It has a special metal resistive element and suitable barrier layers beneath the solder to prolong terminal life. Following the developments by semiconductor manufacturers in the production of a range of IC's for battery charge management and low voltage power supplies, the TLR Series satisfies the demand for a low ohmic shunt resistor to act as a current sensor. It has particular applications in the automotive industry for sensing in EMU's.

**Characteristics – Electrical (Standard)**

Size	Power Rating @ 70°C	Resistance Range (mΩ)			TCR (PPM/°C)
		±1%	±3%	±5%	
1206	1W	0.5			±200
1206	1W	0.75 ~ 10			±50
2512	1W	0.5, 0.75, 1, 1.5, 2			±50
2512	1W	6, 6.5, 7			±75
2512	1W	4, 5, 10			±100
2512	1W	2.5, 3			±150

Operating Temperature Range: -55 ~ 170°C

Operating Current =  $\sqrt{P/R}$ , Operating Voltage =  $\sqrt{P \cdot R}$

**Characteristics – Electrical (High Power)**

Size	Power Rating @ 70°C	Resistance Range (mΩ)			TCR (PPM/°C)
		±1%	±3%	±5%	
2010	1.5W	0.5			±100
2010	1.5W	0.75 ~ 10			±50
2512	2W	0.5, 0.75, 1, 1.5, 2			±50
2512	2W	6, 6.5, 7			±75
2512	2W	4, 5, 10			±100
2512	2W	2.5, 3			±150
2512	3W	0.5, 0.75, 1, 1.5, 2			±50

Operating Temperature Range: -55 ~ 170°C

Operating Current =  $\sqrt{P/R}$ , Operating Voltage =  $\sqrt{P \cdot R}$

**Construction and Dimensions**

2512

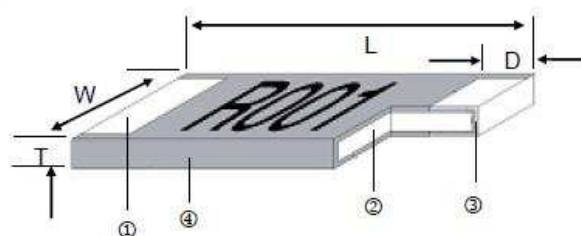

1	Solder Plating	3	Barrier Layer
2	Alloy plate	4	Overcoat

1206 & 2010

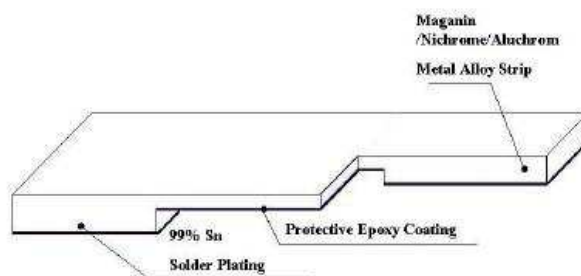

Value	Material
0.5mΩ ~ 3mΩ	Manganese, Copper
3.5mΩ ~ 10mΩ	Aluminium, Iron, Chromium

NB. 1206 and 2010 size – No Coating / Marking

**Dimensions:**

Part number	Resistance mΩ	L	W	T	D	Weight (g) 1000 pcs
TLR2B10FR0005*TDG	0.5	3.20 ±0.25	1.60 ±0.10	0.60 ±0.20	1.35 ±0.25	22.6
TLR2B10DR00075*TDG	0.75	3.20 ±0.25	1.60 ±0.10	0.60 ±0.20	1.23 ±0.25	22.6
TLR2B10D**TDG	1.0, 3.5, 4.0, 5.0, 6.0	3.20 ±0.25	1.60 ±0.10	0.60 ±0.20	1.10 ±0.25	22.6
TLR2B10D**TDG	2.0, 3.0, 10	3.20 ±0.25	1.60 ±0.10	0.60 ±0.20	0.60 ±0.25	22.6
TLR2B10D**TDG	1.2, 1.5, 7.0, 8.0, 9.0	3.20 ±0.25	1.60 ±0.10	0.60 ±0.20	0.90 ±0.25	22.6
TLR2H15ER0005*TDG	0.5	5.08 ±0.25	2.54 ±0.15	0.60 ±0.20	2.17 ±0.25	42.3
TLR2H15DR00075*TDG	0.75	5.08 ±0.25	2.54 ±0.15	0.60 ±0.20	2.04 ±0.25	42.3
TLR2H15D**TDG	1.0, 1.5	5.08 ±0.25	2.54 ±0.15	0.60 ±0.20	1.84 ±0.25	42.3
TLR2H15D**TDG	2.0, 6.0, 7.0, 8.0	5.08 ±0.25	2.54 ±0.15	0.60 ±0.20	1.54 ±0.25	42.3
TLR2H15D**TDG	3.0, 3.5	5.08 ±0.25	2.54 ±0.15	0.60 ±0.20	1.04 ±0.25	42.3
TLR2H15D**TDG	4.0, 5.0, 5.5	5.08 ±0.25	2.54 ±0.15	0.60 ±0.20	1.84 ±0.25	42.3
TLR2H15D**TDG	9.0, 10	5.08 ±0.25	2.54 ±0.15	0.60 ±0.20	1.29 ±0.25	42.3
TLR3A**DR0005TDG	0.5	6.35 ±0.254	3.18 ±0.254	1.25 ±0.20	1.30 ±0.38	184.11
TLR3A**DR00075TDG	0.75	6.35 ±0.254	3.18 ±0.254	0.75 ±0.20	1.30 ±0.38	131.11
TLR3A**DR001TDG	1.0	6.35 ±0.254	3.18 ±0.254	0.65 ±0.20	1.30 ±0.38	110.85
TLR3A**DR0015TDG	1.5	6.35 ±0.254	3.18 ±0.254	0.45 ±0.20	1.30 ±0.38	67.16
TLR3A**DR002TDG	2.0	6.35 ±0.254	3.18 ±0.254	0.35 ±0.20	1.30 ±0.38	49.30
TLR3A**KR0025TDG	2.5	6.35 ±0.254	3.18 ±0.254	0.65 ±0.20	1.30 ±0.38	97.95
TLR3A**KR003TDG	3.0	6.35 ±0.254	3.18 ±0.254	0.55 ±0.20	1.30 ±0.38	83.49
TLR3A**ER004TDG	4.0	6.35 ±0.254	3.18 ±0.254	0.45 ±0.20	1.30 ±0.38	62.59
TLR3A**ER005TDG	5.0	6.35 ±0.254	3.18 ±0.254	0.35 ±0.20	1.30 ±0.38	49.84
TLR3A**WR006TDG	6.0	6.35 ±0.254	3.18 ±0.254	0.32 ±0.20	1.30 ±0.38	41.76
TLR3A**WR0065TDG	6.5	6.35 ±0.254	3.18 ±0.254	0.30 ±0.20	1.30 ±0.38	35.85
TLR3A**WR007TDG	7.0	6.35 ±0.254	3.18 ±0.254	0.27 ±0.20	1.30 ±0.38	34.01
TLR3A**ER010TDG	10	6.35 ±0.254	3.18 ±0.254	0.25 ±0.20	1.30 ±0.38	25.97

## Marking – 2512 only

### Resistance (3 digit)

Resistance	0.5mΩ	0.75mΩ
Codes	M50	M75

### Resistance (4 Digit)

Resistance	1mΩ	2mΩ	7mΩ	10mΩ
Codes	R001	R002	R007	R010

## Solder Profile

### Reflow

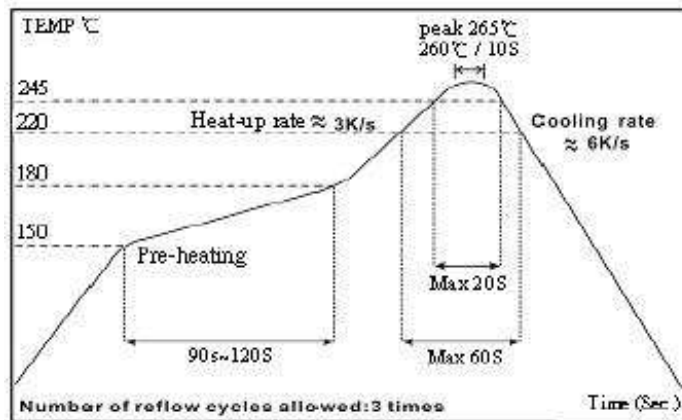

## Derating Curve

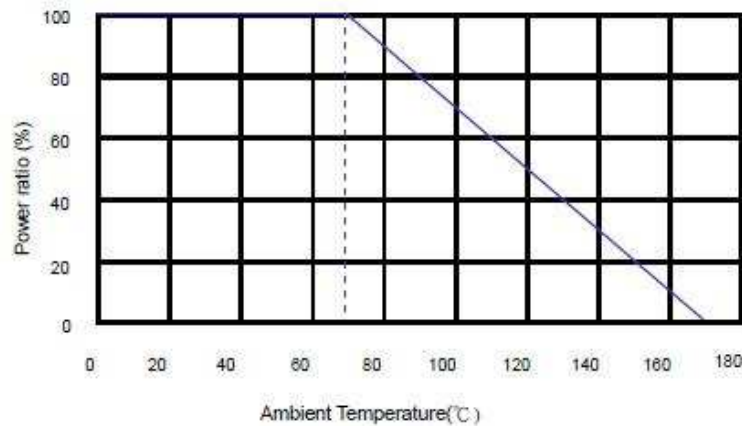

### Environmental Characteristics

Item	Requirement	Test Method
Temperature Coefficient of Resistance (T.C.R.)	As Spec.	<b>MIL-STD-202 Method 304</b> +25°C ~125°C, 25°C is the reference temperature
Short Term Overload	±0.5%	<b>JIS-C-5201-1 5.5</b> 5*rated power for 5 seconds
Endurance	±1%	<b>MIL-STD-202 Method 108A</b> 70±2°C, RCWV for 1000 hrs with 1.5 hrs "ON" and 0.5 hr "OFF"
Dry Heat	±1%	<b>JIS-C-5201-1 7.2</b> at +170°C for 1000 hrs
Solderability	95% Minimum Coverage	<b>MIL-STD-202 Method 208H</b> 245±5°C for 3 seconds
Resistance to Soldering Heat	±0.5%	<b>MIL-STD-202 Method 210E</b> 260±5°C for 10 seconds
Thermal Shock	±0.5%	<b>MIL-STD-202 Method 107G</b> -55°C ~ 150°C, 100 cycles

### Packaging

Reel Dimensions (mm)

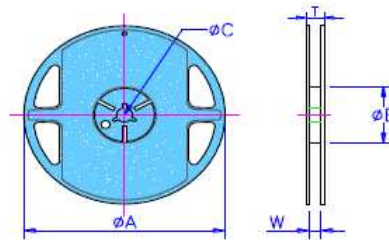

Tape Width	Reel Diameter	ØA	ØB	ØC	W	T
8mm	7 Inch	178.5±1.5	60 <sup>+1-0</sup>	13.0±0.2	9.0±0.5	12.5±0.5
12mm			60±1.0		13.0±1.0	15.5±0.5

### Embossed Plastic Tape specification

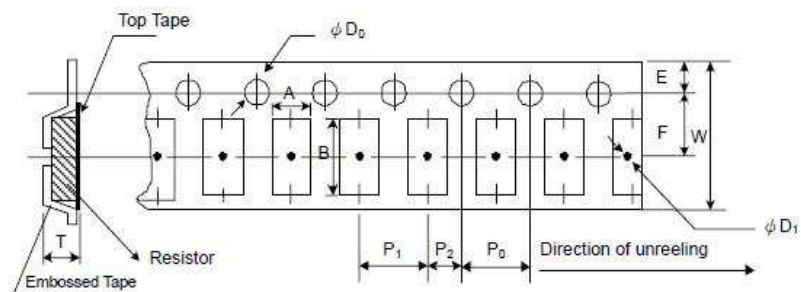

Size	Res mΩ	A ±0.1	B ±0.1	W ±0.2	E ±0.1	F ±0.5	P <sub>0</sub> ±0.1	P <sub>1</sub> ±0.1	P <sub>2</sub> ±0.05	∅D <sub>0</sub> ±0.05	∅D <sub>1</sub> min	T ±0.2	Qty
2B	All	1.90	3.60	8.0	1.75	3.5	4.0	4.0	2.0	1.55	1.0	0.87	2000
2H	All	2.85	5.55	12.0	1.75	5.5	4.0	4.0	2.0	1.55	1.4	0.85	2000
3A	≤0.75	3.40	6.75	12.0	1.75	5.5	4.0	4.0	2.0	1.55	1.4	1.45	2000
	1-10											0.81	

1. The cumulative tolerance of 10 sprockets hole pitch is ±0.2mm.
2. Carrier camber shall be not more than 1mm per 100mm through a length of 250mm.
3. A & B measured 0.3mm from the bottom of the packet
4. T measured at a point on the inside bottom of the packet to the top surface of the carrier.
5. Pocket position relative to sprocket hole is measured as the true position of the pocket and not the pocket hole.

## Measurements

### 1. TLR3A 4-wire precision measurement

Equipment: ADEX AX-1152D DC Low Ohm Meter

Excitation Current: 3A (0.5mΩ~1.5 mΩ) 1A (2mΩ~10mΩ)

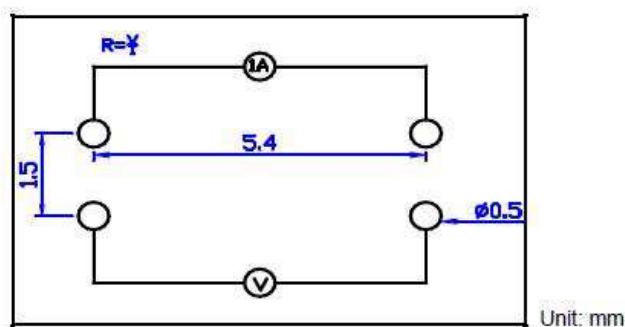

### 2. TLR3A 4-wire pad layout (recommended for precision current sensing)

■Note: No circuits between pads to avoid short circuit

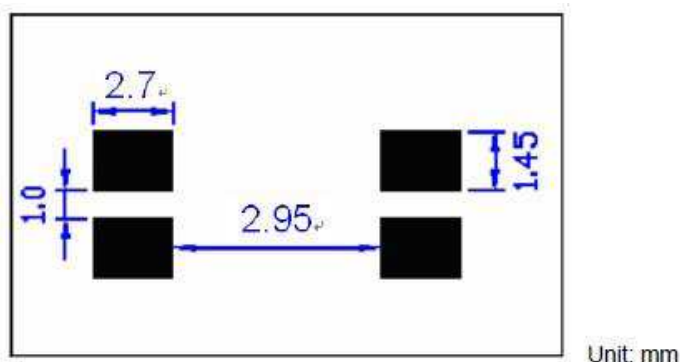

### 3. TLR3A 2-wire pad layout

- Note: No circuits between pads to avoid short circuit

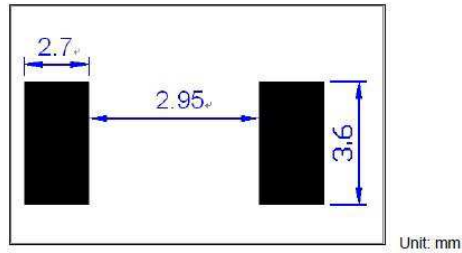

### 4. TLR 2B 4-wire precision measurement

- Equipment: ADEX AX-1152D DC Low Ohm Meter
- Excitation Current: 1A (0.5mΩ~10mΩ)

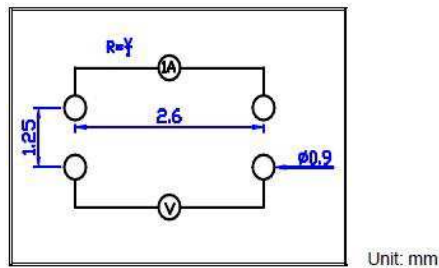

### 5. TLR2B 4-wire pad layout (recommended for precision current sensing)

- Note: No circuits between pads to avoid short circuit

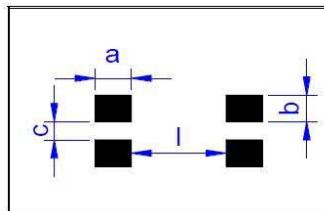

Type	Item	a m/m	b m/m	c m/m	l m/m
	0M50	1.80	0.7	0.5	0.55
	0M75	1.68	0.7	0.5	0.55
	R001	1.55	0.7	0.5	0.55
	1M2	1.35	0.7	0.5	0.95
	1M5	1.35	0.7	0.5	1.55
	R002~R003	1.05	0.7	0.5	1.55
	3M5~R006	1.55	0.7	0.5	0.55
	R007~R009	1.35	0.7	0.5	0.95
	R010	1.05	0.7	0.5	1.55

### 6. TLR2B 2-wire pad layout

- Note: No circuits between pads to avoid short circuit

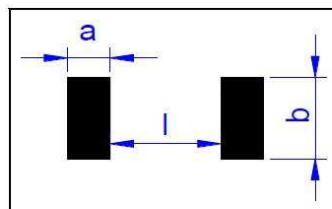

Type	Item	a m/m	b m/m	l m/m
	0M50	1.80	1.90	0.55
	0M75	1.68	1.90	0.55
	R001	1.55	1.89	0.55
	1M2	1.35	1.90	0.95
	1M5	1.35	1.89	1.55
	R002~R003	1.05	1.89	1.55
	3M5~R006	1.55	1.89	0.55
	R007~R009	1.35	1.89	0.95
	R010	1.05	1.89	1.55

### 7. TLR2H 4-wire precision measurement

- Equipment: ADEX AX-1152D DC Low Ohm Meter
- Excitation Current: 1A (0.5mΩ~10mΩ)

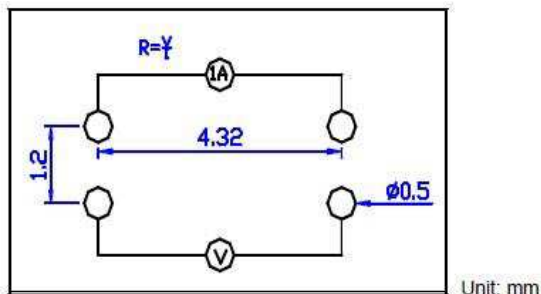

### 8. TLR2H 4-wire pad layout (recommended for precision current sensing)

- Note: No circuits between pads to avoid short circuit

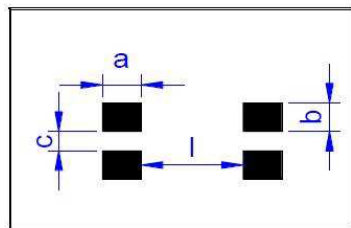

Type	Item	a m/m	b m/m	c m/m	l m/m
OM50		2.61	1.045	0.8	0.60
OM75		2.49	1.045	0.8	0.80
R001~1M5		2.29	1.045	0.8	0.95
R002		1.99	1.045	0.8	1.55
R003~3M5		1.49	1.045	0.8	2.55
R004~5M5		2.29	1.045	0.8	0.95
R006~R008		1.99	1.045	0.8	1.55
R009~R010		1.74	1.045	0.8	2.05

### 9. TLR2H 2-wire pad layout

- Note: No circuits between pads to avoid short circuit

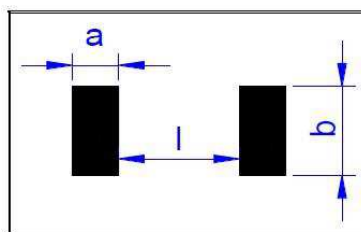

Type	Item	a m/m	b m/m	l m/m
OM50		2.61	2.89	0.60
OM75		2.49	2.89	0.80
R001~1M5		2.29	2.89	0.95
R002		1.99	2.89	1.55
R003~3M5		1.49	2.89	2.55
R004~5M5		2.29	2.89	0.95
R006~R008		1.99	2.89	1.55
R009~R010		1.74	2.89	2.05

### How To Order

TLR	2B	10	D	R005	F	TDG
Common Part	Size	*Power Rating	**TCR (PPM/°C)	Resistance Code	Tolerance	Packaging
TLR – Ultra Low Ohm Metal Strip Resistor	2B – 1206 2H – 2010 3A – 2512	1.0 = 10 1.5 = 15 2.0 = 20 3.0 = 30	D = ±50 W = ±75 E = ±100 K = ±150	R0005 - 0.5mΩ R0015 - 1.5mΩ R002 - 2mΩ	J = ±5% H = ±3% F = ±1%	TDG = 2000 / Reel



# Mouser Electronics

Authorized Distributor

Click to View Pricing, Inventory, Delivery & Lifecycle Information:

## TE Connectivity:

[TLR3A20DR006FTDG](#) [TLR3A20DR008FTDG](#) [TLR3A20DR005FTDG](#) [TLR2H15DR010FTDG](#)  
[TLR3A30DR0015FTDG](#) [TLR3A20DR009FTDG](#) [TLR3A30ER00075FTDG](#) [TLR3A20DR002FTDG](#)  
[TLR3A10DR013FTDG](#) [TLR3A20ER004FTDG](#) [TLR3A20ER010FTDG](#) [TLR3A10DR008FTDG](#) [TLR3A25DR006FTDG](#)  
[TLR3A10WR033FTDG](#) [TLR2H15DR001FTDG](#) [TLR2B10WR015FTDG](#) [TLR3A10ER004FTDG](#) [TLR3A25DR005FTDG](#)  
[TLR3A30WR010FTDG](#) [TLR3A20DR007FTDG](#) [TLR3A20WR10FTDG](#) [TLR3A20WR006FTDG](#) [TLR3A10DR015FTDG](#)  
[TLR2H10ER006FTDG](#) [TLR2B10WR012FTDG](#) [TLR3A20KR0025FTDG](#) [TLR3A10DR002FTDG](#)  
[TLR3A30WR018FTDG](#) [TLR3A25DR004FTDG](#) [TLR2B10DR004FTDG](#) [TLR3A20WR030FTDG](#) [TLR3A10WR010FTDG](#)  
[TLR2B10DR007FTDG](#) [TLR2B10DR002FTDG](#) [TLR2H10WR015FTDG](#) [TLR2H10ER01FTDG](#) [TLR3A30WR020FTDG](#)  
[TLR2B10DR009FTDG](#) [TLR2H10WR020FTDG](#) [TLR3A20DR00075FTDG](#) [TLR2H15DR002FTDG](#)  
[TLR3A20DR0065FTDG](#) [TLR2B10WR020FTDG](#) [TLR3A25DR0045FTDG](#) [TLR3A20WR015FTDG](#)  
[TLR2B10DR006FTDG](#) [TLR2H15WR020FTDG](#) [TLR3A30DR002FTDG](#) [TLR3A10DR012FTDG](#) [TLR2B10DR008FTDG](#)  
[TLR3A10ER005FTDG](#) [TLR2B10WR030FTDG](#) [TLR3A20WR007FTDG](#) [TLR2B10DR003FTDG](#) [TLR3A30WR10FTDG](#)  
[TLR3A30WR030FTDG](#) [TLR3A20WR020FTDG](#) [TLR3A10WR10FTDG](#) [TLR2H15DR005FTDG](#) [TLR2B10WR022FTDG](#)  
[TLR3A20WR075FTDG](#) [TLR3A10WR012FTDG](#) [TLR3A10WR030FTDG](#) [TLR2B10DR001FTDG](#)  
[TLR3A10KR003FTDG](#) [TLR3A10KR0025FTDG](#) [TLR3A10WR006FTDG](#) [TLR2H15DR006FTDG](#)  
[TLR3A10DR0015FTDG](#) [TLR3A10WR007FTDG](#)