

Click [here](#) to ask about the production status of specific part numbers.

## MAX14937

## Two Channel, 5kV<sub>RMS</sub> I<sup>2</sup>C Isolator

### General Description

The MAX14937 is a two-channel, 5kV<sub>RMS</sub> I<sup>2</sup>C digital isolator utilizing Maxim's proprietary process technology. For applications requiring 2.75kV<sub>RMS</sub> of isolation, see the MAX14933 data sheet. The device transfers digital signals between circuits with different power domains at ambient temperatures up to +125°C.

The device offers two bidirectional, open-drain channels for applications, such as I<sup>2</sup>C, that require data to be transmitted in both directions on the same line. To prevent latch-up action, the A-side outputs comprise special buffers that regulate the logic-low voltage at 0.9V (max), and the input logic-low threshold is at least 50mV lower than the output logic-low voltage. The B side features conventional buffers that do not regulate logic-low output voltage.

The device features independent 2.25V to 5.5V supplies on each side of the isolator. The MAX14937 operates from DC to 1.7MHz and can be used in isolated I<sup>2</sup>C busses with clock stretching.

The MAX14937 is available in a 16-pin, wide-body (10.3mm x 7.5mm) SOIC package, and is rated for operation at ambient temperatures of -40°C to +125°C.

### Applications

- I<sup>2</sup>C, SMBus, PMBus™ Interfaces
- Power Supplies
- Battery Management
- Instrumentation

### Benefits and Features

- Robust Galvanic Isolation of Digital Signals
  - Withstands 5kV<sub>RMS</sub> for 60s (V<sub>ISO</sub>)
  - Continuously Withstands 848V<sub>RMS</sub> (V<sub>IOWM</sub>)
  - 1200V<sub>PEAK</sub> Repetitive Peak Voltage (V<sub>IORM</sub>)
  - Withstands ±10kV Surge per IEC 61000-4-5
- Interfaces Directly with Most Micros and FPGAs
  - Accepts 2.25V to 5.5V Supplies
  - Bidirectional Data Transfer from DC to 1.7MHz
- Low Power Consumption
  - 5.3mA per Channel Typical at 1.7MHz

### Safety Regulatory Approvals

(See [Safety Regulatory Approvals](#))

- UL According to UL1577
- cUL According to CSA Bulletin 5A
- VDE 0884-11 Basic Insulation

[Ordering Information](#) appears at end of data sheet.

### Functional Diagram

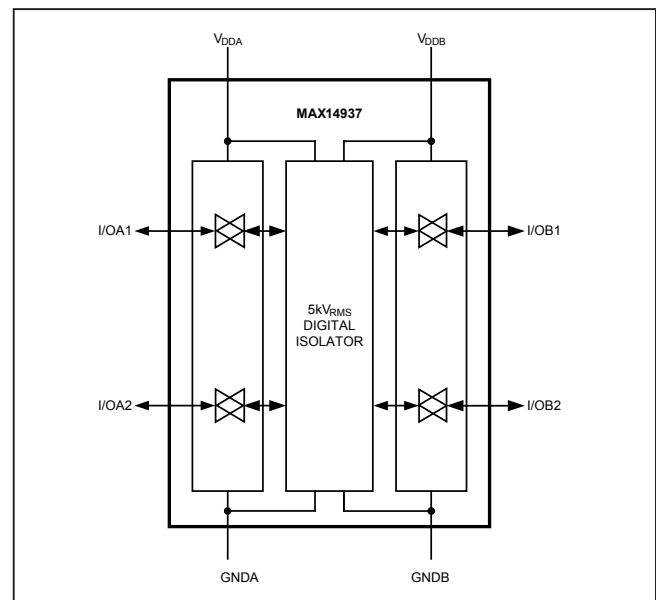

PMBus is a trademark of SMIF, Inc.

**Absolute Maximum Ratings**

V <sub>DDA</sub> to G <sub>NDA</sub> .....	-0.3V to +6V	Continuous Power Dissipation (T <sub>A</sub> = +70°C)
V <sub>DDB</sub> to G <sub>NDB</sub> .....	-0.3V to +6V	Wide SOIC (derate 14.1mW/°C above +70°C) .....
I/OA <sub>_</sub> to G <sub>NDA</sub> .....	-0.3V to +6V	Operating Temperature Range .....
I/OB <sub>_</sub> to G <sub>NDB</sub> .....	-0.3V to +6V	Maximum Junction Temperature .....
Short-Circuit Duration		Storage Temperature Range .....
(I/OA <sub>_</sub> to G <sub>NDA</sub> , I/OB <sub>_</sub> to G <sub>NDB</sub> ) .....	Continuous	Lead Temperature (soldering, 10s) .....
		Soldering Temperature (reflow) .....

Stresses beyond those listed under "Absolute Maximum Ratings" may cause permanent damage to the device. These are stress ratings only, and functional operation of the device at these or any other conditions beyond those indicated in the operational sections of the specifications is not implied. Exposure to absolute maximum rating conditions for extended periods may affect device reliability.

**Package Information**

**16 Wide SOIC**

Package Code	W16M+8
Outline Number	<a href="#">21-0042</a>
Land Pattern Number	<a href="#">90-0107</a>
<b>THERMAL RESISTANCE, FOUR-LAYER BOARD</b>	
Junction-to-Ambient Thermal Resistance (θ <sub>JA</sub> )	71°C/W
Junction-to-Case Thermal Resistance (θ <sub>JC</sub> )	23°C/W

For the latest package outline information and land patterns (footprints), go to [www.maximintegrated.com/packages](http://www.maximintegrated.com/packages). Note that a "+", "#", or "-" in the package code indicates RoHS status only. Package drawings may show a different suffix character, but the drawing pertains to the package regardless of RoHS status.

Package thermal resistances were obtained using the method described in JEDEC specification JESD51-7, using a four-layer board. For detailed information on package thermal considerations, refer to [www.maximintegrated.com/thermal-tutorial](http://www.maximintegrated.com/thermal-tutorial).

## DC Electrical Characteristics

( $V_{DDA} - V_{GNDA} = +2.25V$  to  $+5.5V$ ,  $V_{DDB} - V_{GNDB} = +2.25V$  to  $+5.5V$ ,  $T_A = -40^{\circ}C$  to  $+125^{\circ}C$ , unless otherwise noted. Typical values are at  $V_{DDA} - V_{GNDA} = +3.3V$ ,  $V_{DDB} - V_{GNDB} = +3.3V$ ,  $V_{GNDA} = V_{GNDB}$ ,  $T_A = +25^{\circ}C$ , unless otherwise noted.) (Notes 1 and 2)

PARAMETER	SYMBOL	CONDITIONS	MIN	TYP	MAX	UNITS
<b>POWER SUPPLY</b>						
Operating Supply Voltage	$V_{DDA}$	Relative to GNDA	2.25		5.5	V
	$V_{DDB}$	Relative to GNDB	2.25		5.5	V
Undervoltage-Lockout Threshold	$V_{UVLO\_}$	$V_{DD}$ rising	1.7	2.0	2.2	V
Undervoltage-Lockout Threshold Hysteresis	$V_{UVLO\_}$ HYST			85		mV
Supply Current	$I_{DDA}$	Side A, all channels DC or 1.7MHz	$V_{DDA} = 5V$	6	9	mA
			$V_{DDA} = 3.3V$	6	9	
			$V_{DDA} = 2.5V$	5.9	9	
	$I_{DDB}$	Side B, all channels DC or 1.7MHz	$V_{DDB} = 5V$	4.8	8	
			$V_{DDB} = 3.3V$	4.8	8	
			$V_{DDB} = 2.5V$	4.7	8	
Static Output Loading	$I_{I/OA\_}$	Side A	0.5		3	mA
	$I_{I/OB\_}$	Side B	0.5		30	
<b>LOGIC INPUTS AND OUTPUTS</b>						
Input High Voltage	$V_{IH}$	$V_{I/OA\_}$ relative to GNDA	0.7			V
		$V_{I/OB\_}$ relative to GNDB	$0.7 \times V_{DDB}$			
Input Low Voltage	$V_{IL}$	$V_{I/OA\_}$ relative to GNDA		0.5		V
		$V_{I/OB\_}$ relative to GNDB		$0.3 \times V_{DDB}$		
Input/Output Logic-Low Level Difference	$DV_{I/OL}$	$I_{I/OA\_}$ (Note 3), $V_{OL} - V_{IL}$	50			mV
Output Voltage Low	$V_{OL}$	$V_{I/OA\_}$ relative to GNDA, $I_{I/OA\_} = 3mA$ sink	600		900	mV
		$V_{I/OA\_}$ relative to GNDA, $I_{I/OA\_} = 0.5mA$ sink	600		850	
		$V_{I/OB\_}$ relative to GNDB, $I_{I/OB\_} = 30mA$ sink			400	
Leakage Current	$I_L$	$I_{I/OA\_} = V_{DDA}$ , $I_{I/OB\_} = V_{DDB}$	-1		+1	$\mu A$
Input Capacitance	$C_{IN}$	$I_{I/OA\_}$ , $I_{I/OB\_}$ , $f = 1MHz$		5		pF

**Dynamic Characteristics**

(V<sub>DDA</sub> - V<sub>GNDA</sub> = +2.25V to +5.5V, V<sub>DDB</sub> - V<sub>GNDB</sub> = +2.25V to +5.5V, T<sub>A</sub> = -40°C to +125°C, unless otherwise noted. Typical values are at V<sub>DDA</sub> - V<sub>GNDA</sub> = +3.3V, V<sub>DDB</sub> - V<sub>GNDB</sub> = +3.3V, V<sub>GNDA</sub> = V<sub>GNDB</sub>, T<sub>A</sub> = +25°C, unless otherwise noted.) (Note 4)

PARAMETER	SYMBOL	CONDITIONS		MIN	TYP	MAX	UNITS
Common-Mode Transient Immunity	CMTI	IN_ = GND_ or V <sub>DD_</sub> (Note 5)		25			kV/μs
Maximum Frequency	f <sub>MAX</sub>			1.7			MHz
Fall Time (Figure 1)	t <sub>FA</sub>	I/OA_ = 0.9V <sub>DDA</sub> to 0.9V	4.5V ≤ V <sub>DDA</sub> , V <sub>DDB</sub> ≤ 5.5V, C <sub>LA</sub> = 40pF, R <sub>A</sub> = 1.6kΩ, C <sub>LB</sub> = 400pF, R <sub>B</sub> = 180Ω	80			ns
			3.0V ≤ V <sub>DDA</sub> , V <sub>DDB</sub> ≤ 3.6V, C <sub>LA</sub> = 40pF, R <sub>A</sub> = 1kΩ, C <sub>LB</sub> = 400pF, R <sub>B</sub> = 120Ω	65			
			2.25V ≤ V <sub>DDA</sub> , V <sub>DDB</sub> ≤ 2.75V, C <sub>LA</sub> = 40pF, R <sub>A</sub> = 810Ω, C <sub>LB</sub> = 400pF, R <sub>B</sub> = 91Ω	55			
	t <sub>FB</sub>	I/OB_ = 0.9V <sub>DDB</sub> to 0.1V <sub>DDB</sub>	4.5V ≤ V <sub>DDA</sub> , V <sub>DDB</sub> ≤ 5.5V, C <sub>LA</sub> = 40pF, R <sub>A</sub> = 1.6kΩ, C <sub>LB</sub> = 400pF, R <sub>B</sub> = 180Ω	35			
			3.0V ≤ V <sub>DDA</sub> , V <sub>DDB</sub> ≤ 3.6V, C <sub>LA</sub> = 40pF, R <sub>A</sub> = 1kΩ, C <sub>LB</sub> = 400pF, R <sub>B</sub> = 120Ω	45			
			2.25V ≤ V <sub>DDA</sub> , V <sub>DDB</sub> ≤ 2.75V, C <sub>LA</sub> = 40pF, R <sub>A</sub> = 810kΩ, C <sub>LB</sub> = 400pF, R <sub>B</sub> = 91Ω	75			
Propagation Delay (Figure 1)	t <sub>PLHAB</sub>	I/OA_ = 0.5V <sub>DDA</sub> to I/OB_ = 0.7V <sub>DDB</sub>	4.5V ≤ V <sub>DDA</sub> , V <sub>DDB</sub> ≤ 5.5V, C <sub>LA</sub> = 0pF, R <sub>A</sub> = 1.6kΩ, C <sub>LB</sub> = 0pF, R <sub>B</sub> = 180Ω	20			ns
			3.0V ≤ V <sub>DDA</sub> , V <sub>DDB</sub> ≤ 3.6V, C <sub>LA</sub> = 0pF, R <sub>A</sub> = 1kΩ, C <sub>LB</sub> = 0pF, R <sub>B</sub> = 120Ω	25			
			2.25V ≤ V <sub>DDA</sub> , V <sub>DDB</sub> ≤ 2.75V, C <sub>LA</sub> = 0pF, R <sub>A</sub> = 810Ω, C <sub>LB</sub> = 0pF, R <sub>B</sub> = 91Ω	35			
	t <sub>PHLAB</sub>	I/OA_ = 0.5V <sub>DDA</sub> to I/OB_ = 0.4V	4.5V ≤ V <sub>DDA</sub> , V <sub>DDB</sub> ≤ 5.5V, C <sub>LA</sub> = 0pF, R <sub>A</sub> = 1.6kΩ, C <sub>LB</sub> = 0pF, R <sub>B</sub> = 180Ω	80			
			3.0V ≤ V <sub>DDA</sub> , V <sub>DDB</sub> ≤ 3.6V, C <sub>LA</sub> = 0pF, R <sub>A</sub> = 1kΩ, C <sub>LB</sub> = 0pF, R <sub>B</sub> = 120Ω	95			
			2.25V ≤ V <sub>DDA</sub> , V <sub>DDB</sub> ≤ 2.75V, C <sub>LA</sub> = 0pF, R <sub>A</sub> = 810Ω, C <sub>LB</sub> = 0pF, R <sub>B</sub> = 91Ω	110			

**Dynamic Characteristics (continued)**

(V<sub>DDA</sub> - V<sub>GNDA</sub> = +2.25V to +5.5V, V<sub>DDB</sub> - V<sub>GNDB</sub> = +2.25V to +5.5V, T<sub>A</sub> = -40°C to +125°C, unless otherwise noted. Typical values are at V<sub>DDA</sub> - V<sub>GNDA</sub> = +3.3V, V<sub>DDB</sub> - V<sub>GNDB</sub> = +3.3V, V<sub>GNDA</sub> = V<sub>GNDB</sub>, T<sub>A</sub> = +25°C, unless otherwise noted.) (Note 4)

PARAMETER	SYMBOL	CONDITIONS			MIN	TYP	MAX	UNITS
Propagation Delay (Figure 1)	t <sub>PLHBA</sub>	I/OB <sub>-</sub> = 0.5V <sub>DDB</sub> to I/OA <sub>-</sub> = 0.7V <sub>DDA</sub>	4.5V ≤ V <sub>DDA</sub> , V <sub>DDB</sub> ≤ 5.5V, C <sub>LA</sub> = 0pF, R <sub>A</sub> = 1.6kΩ, C <sub>LB</sub> = 0pF, R <sub>B</sub> = 180Ω			25	ns	
			3.0V ≤ V <sub>DDA</sub> , V <sub>DDB</sub> ≤ 3.6V, C <sub>LA</sub> = 0pF, R <sub>A</sub> = 1kΩ, C <sub>LB</sub> = 0pF, R <sub>B</sub> = 120Ω			25		
			2.25V ≤ V <sub>DDA</sub> , V <sub>DDB</sub> ≤ 2.75V, C <sub>LA</sub> = 0pF, R <sub>A</sub> = 810Ω, C <sub>LB</sub> = 0pF, R <sub>B</sub> = 91Ω			35		
	t <sub>PHLBA</sub>	I/OB <sub>-</sub> = 0.5V <sub>DDB</sub> to I/OA <sub>-</sub> = 0.9V	4.5V ≤ V <sub>DDA</sub> , V <sub>DDB</sub> ≤ 5.5V, C <sub>LA</sub> = 0pF, R <sub>A</sub> = 1.6kΩ, C <sub>LB</sub> = 0pF, R <sub>B</sub> = 180Ω			115		
			3.0V ≤ V <sub>DDA</sub> , V <sub>DDB</sub> ≤ 3.6V, C <sub>LA</sub> = 0pF, R <sub>A</sub> = 1kΩ, C <sub>LB</sub> = 0pF, R <sub>B</sub> = 120Ω			115		
			2.25V ≤ V <sub>DDA</sub> , V <sub>DDB</sub> ≤ 2.75V, C <sub>LA</sub> = 0pF, R <sub>A</sub> = 810Ω, C <sub>LB</sub> = 0pF, R <sub>B</sub> = 91Ω			125		
Pulse-Width Distortion	PWD <sub>AB</sub>	t <sub>PLHAB</sub> - t <sub>PHLAB</sub>	4.5V ≤ V <sub>DDA</sub> , V <sub>DDB</sub> ≤ 5.5V			65	ns	
			3.0V ≤ V <sub>DDA</sub> , V <sub>DDB</sub> ≤ 3.6V			65		
			2.25V ≤ V <sub>DDA</sub> , V <sub>DDB</sub> ≤ 2.75V			80		
	PWD <sub>BA</sub>	t <sub>PLHBA</sub> - t <sub>PHLBA</sub>	4.5V ≤ V <sub>DDA</sub> , V <sub>DDB</sub> ≤ 5.5V			95		
			3.0V ≤ V <sub>DDA</sub> , V <sub>DDB</sub> ≤ 3.6V			95		
			2.25V ≤ V <sub>DDA</sub> , V <sub>DDB</sub> ≤ 2.75V			100		

**ESD Protection**

PARAMETER	SYMBOL	CONDITIONS	MIN	TYP	MAX	UNITS
ESD		Human body model, all pins		±4		kV

- Note 1:** All devices are 100% production tested at T<sub>A</sub> = +125°C. Specifications over temperature are guaranteed by design.
- Note 2:** All currents into the device are positive; all currents out of the device are negative. All voltages are referenced to ground on the corresponding side of the device, unless otherwise noted.
- Note 3:** This is the minimum difference between the output logic-low level and the input logic threshold. This ensures that there is no possibility of the part latching up the bus to which it is connected.
- Note 4:** Not production tested. Guaranteed by design.
- Note 5:** CMTI is the maximum sustainable common-mode voltage slew rate while maintaining operation. CMTI applies to both rising and falling common-mode voltage edges. Tested with the transient generator connected between GNDA and GNDB (V<sub>CM</sub> = 1000V).

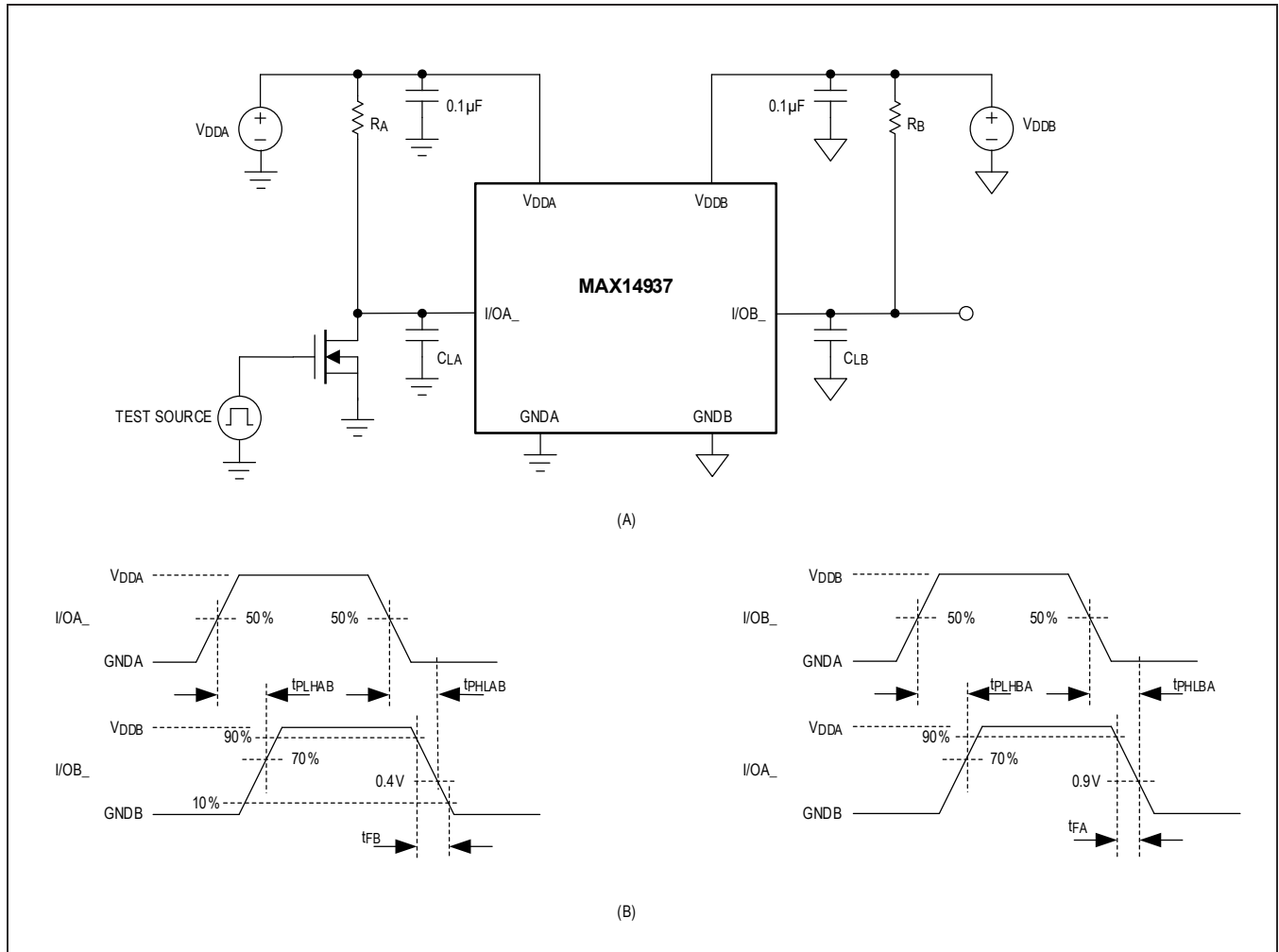

Figure 1. Test Circuit (A) and Timing Diagrams (B)

### Safety Regulatory Approvals

<b>UL</b>
The MAX14937 is certified under UL1577. For more details, refer to file E351759.
Rated up to 5000V <sub>RMS</sub> isolation voltage for single protection.
<b>cUL (Equivalent to CSA notice 5A)</b>
The MAX14937 is certified up to 5000V <sub>RMS</sub> for single protection. For more details, refer to file E351759.
<b>VDE</b>
The MAX14937 is certified to DIN VDE V 0884-11: 2017-01. For details, see file ref. 5015017-4880-0001/272147/TL7/SCT. Basic Insulation, Maximum Transient Isolation Voltage 8400V <sub>PK</sub> , Maximum Repetitive Peak Isolation Voltage 1200V <sub>PK</sub>

*This coupler is suitable for “safe electrical insulation” only within the safety ratings. Compliance with the safety ratings shall be ensured by means of suitable protective circuits.*

## IEC Insulation Testing

<b>TUV</b>
The MAX14937 is tested under TUV.
IEC 60950-1: Up to 1200V <sub>PK</sub> (848V <sub>RMS</sub> ) working voltage for basic insulation.
IEC 61010-1 (ed. 3): Up to 848V <sub>RMS</sub> working voltage for basic insulation. For details, see Technical Report number 095-72100581-100.
IEC 60601-1 (ed. 3): For details see Technical Report number 095-72100581-200.
Basic insulation 1 MOOP, 1200V <sub>PK</sub> (848V <sub>RMS</sub> )
Withstand isolation voltage V <sub>ISO</sub> for 60s 5000V <sub>RMS</sub>

## Insulation Characteristics

PARAMETER	SYMBOL	CONDITIONS	VALUE	UNITS
Partial Discharge Test Voltage	V <sub>PR</sub>	Method B1 = V <sub>IORM</sub> x 1.875 (t = 1s, partial discharge < 5pC)	2250	V <sub>P</sub>
Maximum Repetitive Peak Isolation Voltage	V <sub>IORM</sub>	(Note 6)	1200	V <sub>P</sub>
Maximum Working Isolation Voltage	V <sub>IOWM</sub>	Continuous RMS voltage (Note 6)	848	V <sub>RMS</sub>
Maximum Transient Isolation Voltage	V <sub>IOTM</sub>	t = 1s (Note 6)	8400	V <sub>P</sub>
Maximum Withstand Isolation Voltage	V <sub>ISO</sub>	f <sub>SW</sub> = 60Hz, duration = 60s (Note 6, 7)	5000	V <sub>RMS</sub>
Maximum Surge Isolation Voltage	V <sub>IOSM</sub>	Basic insulation, 1.2/50μs pulse per IEC 61000-4-5 (Note 6, 8)	10	kV
Insulation Resistance	R <sub>IO</sub>	V <sub>IO</sub> = 500V, T <sub>A</sub> = 25°C	> 10 <sup>12</sup>	Ω
		V <sub>IO</sub> = 500V, 100°C ≤ T <sub>A</sub> ≤ 125°C	> 10 <sup>11</sup>	
		V <sub>IO</sub> = 500V at T <sub>S</sub> = 150°C	> 10 <sup>9</sup>	
Barrier Capacitance Side A to Side B	C <sub>IO</sub>	f <sub>SW</sub> = 1MHz (Note 9)	2	pF
Minimum Creepage Distance	CPG	Wide SOIC	8	mm
Minimum Clearance Distance	CLR	Wide SOIC	8	mm
Internal Clearance		Distance through insulation	0.015	mm
Comparative Tracking Index	CTI	Material Group II (IEC 60112)	575	
Climatic Category			40/125/21	
Pollution Degree (DIN VDE 0110, Table 1)			2	

**Note 6:** V<sub>ISO</sub>, V<sub>IOTM</sub>, V<sub>IOSM</sub>, V<sub>IOWM</sub>, and V<sub>IORM</sub> are defined by the IEC 60747-5-5 standard.

**Note 7:** Products are qualified at V<sub>ISO</sub> for 60s and 100% production tested at 120% of V<sub>ISO</sub> for 1s.

**Note 8:** Devices are immersed in oil during surge characterization.

**Note 9:** Capacitance is measured with all pins on field-side and logic-side tied together.

**Safety Limits**

Damage to the IC can result in a low-resistance path to ground or to the supply and, without current limiting, the MAX14937 could dissipate excessive amounts of power. Excessive power dissipation can damage the die and result in damage to the isolation barrier, potentially causing downstream issues. [Table 1](#) shows the safety limits for the MAX14937.

The maximum safety temperature (T<sub>S</sub>) for the device is the 150°C maximum junction temperature specified in the [Absolute Maximum Ratings](#). The power dissipation

(P<sub>D</sub>) and junction-to-ambient thermal impedance (θ<sub>JA</sub>) determine the junction temperature. Thermal impedance values (θ<sub>JA</sub> and θ<sub>JC</sub>) are available in the [Package Information](#) section of the datasheet. Calculate the junction temperature (T<sub>J</sub>) as:

$$T_J = T_A + (P_D \times \theta_{JA})$$

[Figure 2](#) to [Figure 3](#) show the thermal derating curves for the safety power limiting of the device and the safety current limiting of the device. Ensure that the junction temperature does not exceed 150°C.

**Table 1. Safety Limiting Values for the MAX14937**

PARAMETER	SYMBOL	TEST CONDITIONS	MAX	UNITS
Safety Current on Any Pin (No Damage to Isolation Barrier)	I <sub>S</sub>	T <sub>J</sub> = 150°C, T <sub>A</sub> = 25°C	300	mA
Total Safety Power Dissipation	P <sub>S</sub>	T <sub>J</sub> = 150°C, T <sub>A</sub> = 25°C	1760	mW
Maximum Safety Temperature	T <sub>S</sub>		150	°C

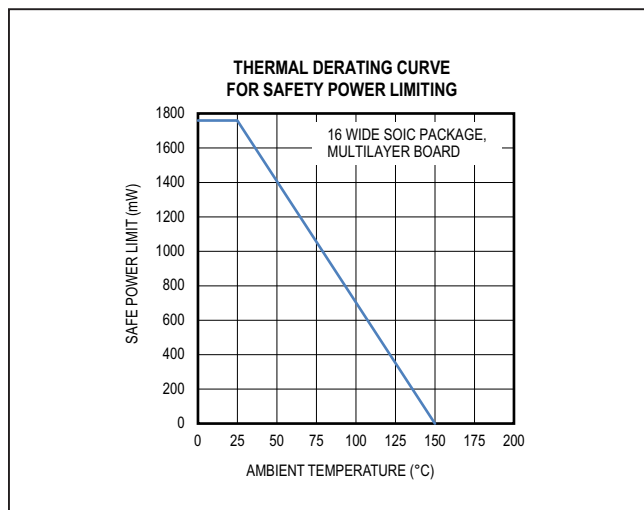

Figure 2. Thermal Derating Curve for Safety Power Limiting

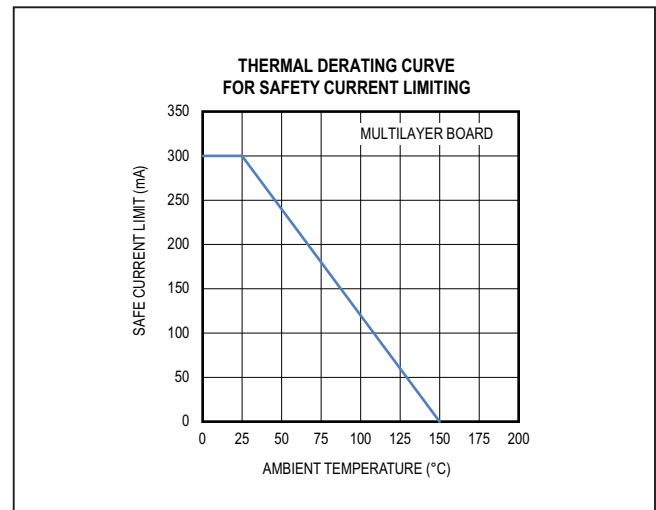
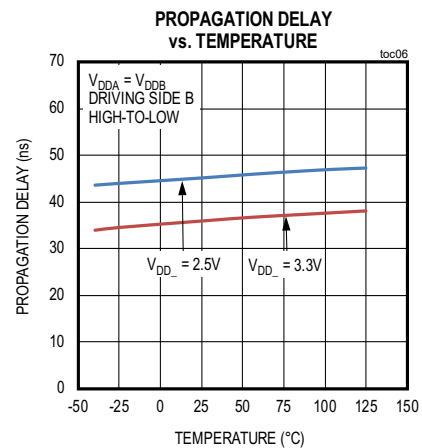
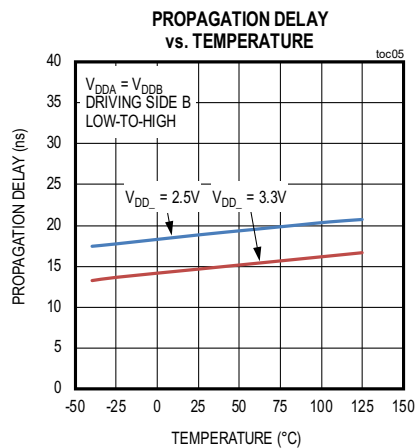
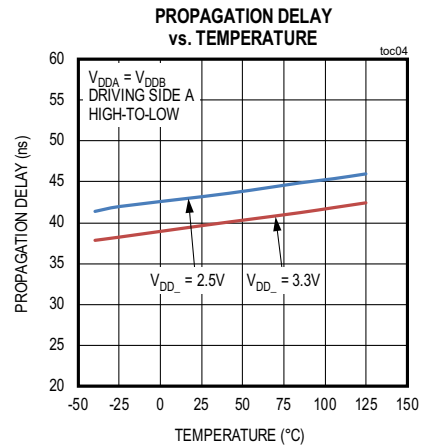
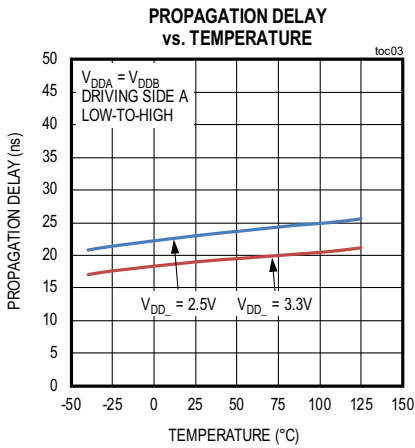
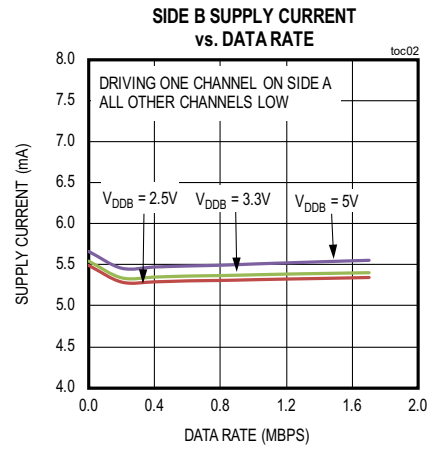
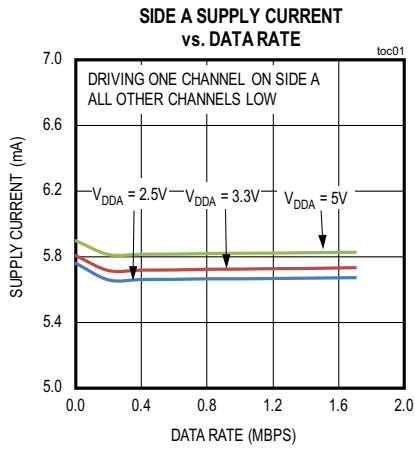

Figure 3. Thermal Derating Curve for Safety Current Limiting



Typical Operating Characteristics

(V<sub>DDA</sub> - V<sub>GNDA</sub> = +3.3V, V<sub>DDB</sub> - V<sub>GNDB</sub> = +3.3V, V<sub>GNDA</sub> = V<sub>GNDB</sub>, T<sub>A</sub> = +25°C, unless otherwise noted.)



**Typical Operating Characteristics (continued)**

( $V_{DDA} - V_{GNDA} = +3.3V$ ,  $V_{DDB} - V_{GNDB} = +3.3V$ ,  $V_{GNDA} = V_{GNDB}$ ,  $T_A = +25^\circ C$ , unless otherwise noted.)

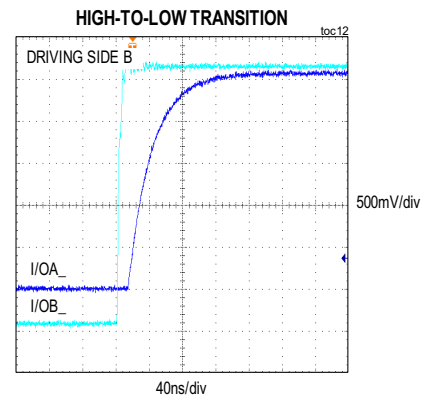
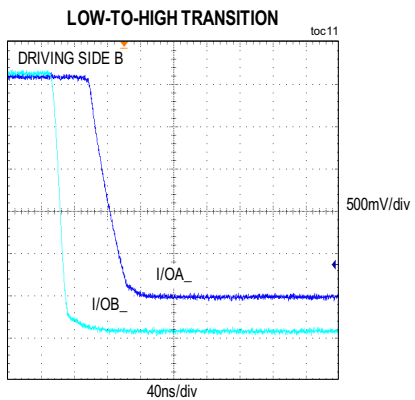
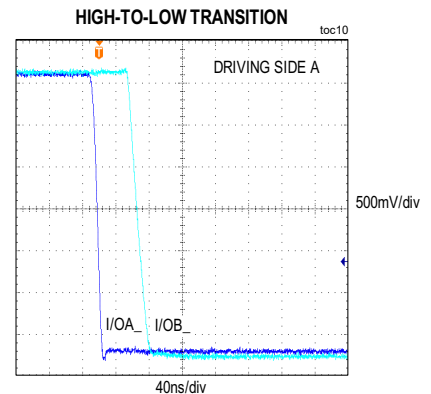
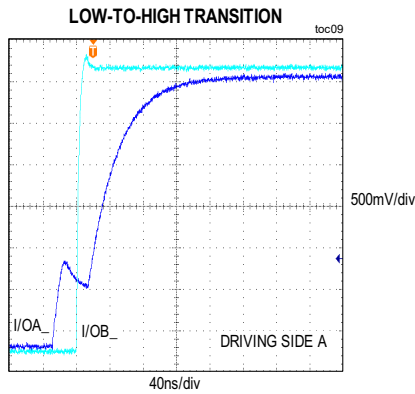
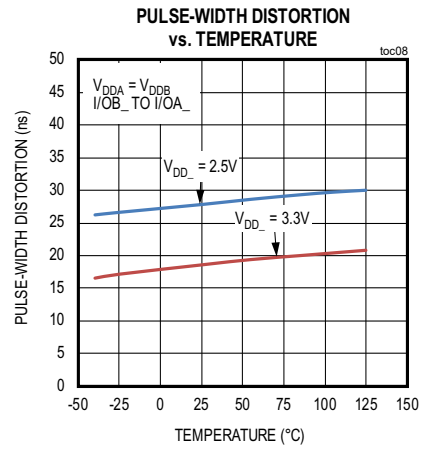
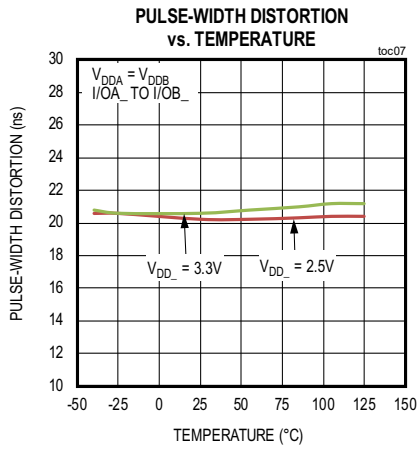

Pin Configuration

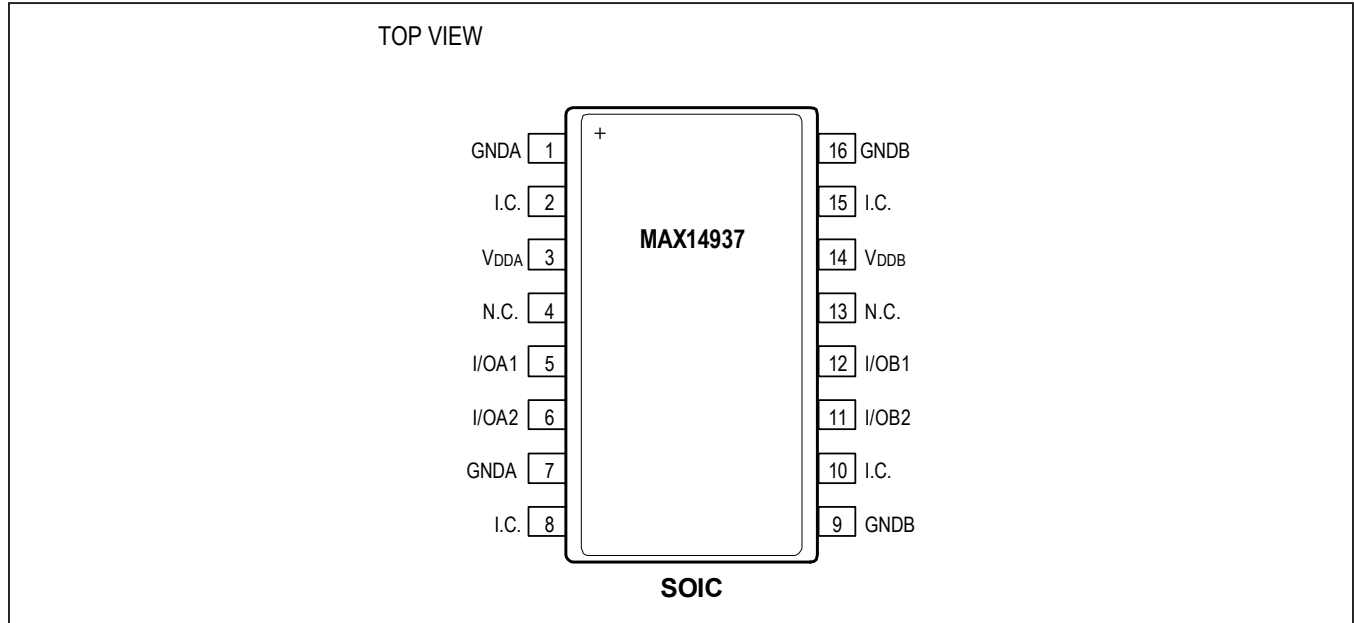

Pin Description

PIN	NAME	FUNCTION	VOLTAGE RELATIVE TO
1, 7	GNDA	Ground Reference For Side A. Ensure both pins 1 and 7 are connected to GNDA.	—
2, 8	I.C.	Internally Connected. Connect to GNDA or leave unconnected.	GNDA
3	V <sub>DDA</sub>	Power Supply. Bypass V <sub>DDA</sub> with a 0.1µF ceramic capacitor as close as possible to the pin.	GNDA
4, 13	N.C.	No Connection. Not internally connected.	—
5	I/OA1	Bidirectional Input/Output 1 On Side A. I/OA1 is translated to/from I/OB1 and is an open-drain output.	GNDA
6	I/OA2	Bidirectional Input/Output 2 On Side A. I/OA2 is translated to/from I/OB2 and is an open-drain output.	GNDA
9, 16	GNDB	Ground Reference For Side B.	—
10, 15	I.C.	Internally Connected. Connect to GNDB or leave unconnected.	GNDB
11	I/OB2	Bidirectional Input/Output 2 On Side B. I/OB2 is translated to/from I/OA2 and is an open-drain output.	GNDB
12	I/OB1	Bidirectional Input/Output 1 On Side B. I/OB1 is translated to/from I/OA1 and is an open-drain output.	GNDB
14	V <sub>DDB</sub>	Power Supply. Bypass V <sub>DDB</sub> with a 0.1µF ceramic capacitor as close as possible to the pin.	GNDB

Typical Application Circuit

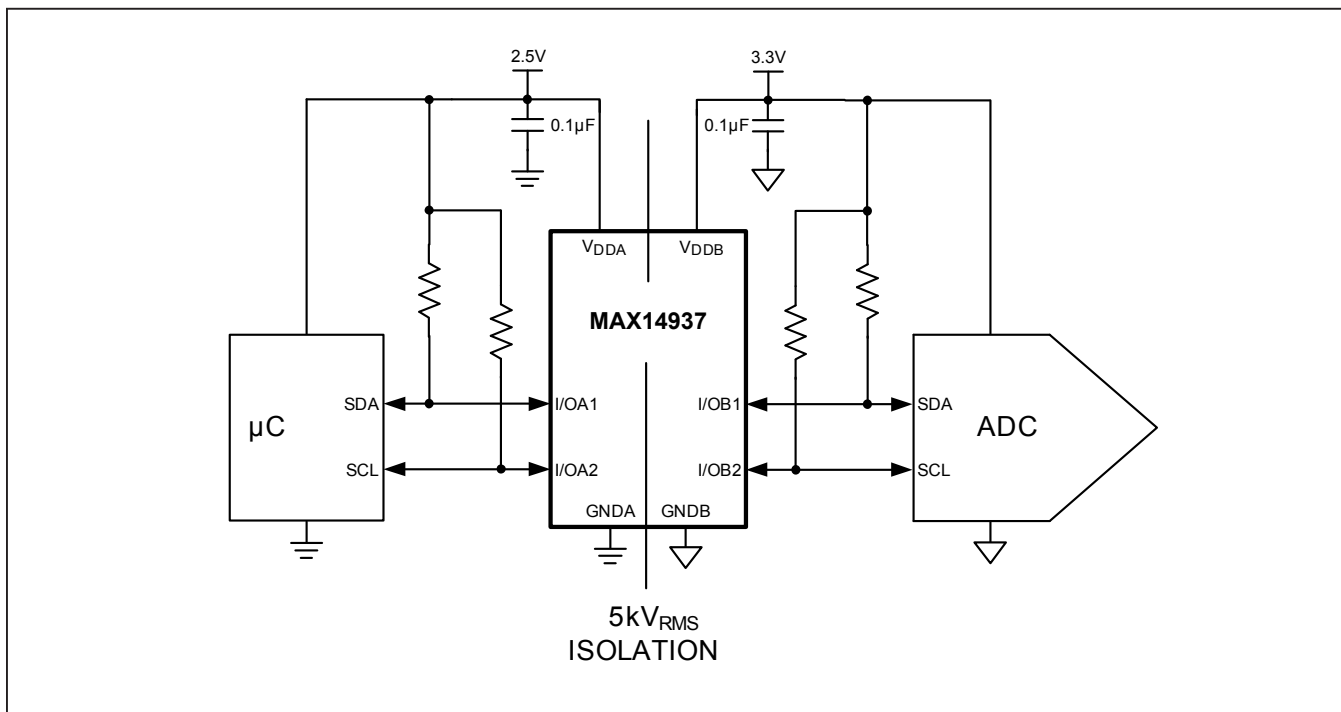

## Detailed Description

The MAX14937 is a two-channel, 5kV<sub>RMS</sub> I<sup>2</sup>C isolator utilizing Maxim's proprietary process technology. For applications requiring 2.75kV<sub>RMS</sub> of isolation, refer to the MAX14933 data sheet. The MAX14937 transfers digital signals between circuits with different power domains at ambient temperatures up to +125°C.

The device offers two bidirectional, open-drain channels for applications, such as I<sup>2</sup>C, that require data to be transmitted in both directions on the same line.

The device features independent 2.25V to 5.5V supplies on each side of the isolator. The device operates from DC to 1.7MHz and can be used in isolated I<sup>2</sup>C busses with clock stretching. The wide temperature range and high isolation voltage make the device ideal for use in harsh industrial environments.

### Digital Isolation

The device provides galvanic isolation for digital signals that are transmitted between two ground domains. Up to 1200V<sub>PEAK</sub> of continuous isolation is supported as well as transient differences of up to 5kV<sub>RMS</sub> for up to 60s.

### Bidirectional Channels

The device features two bidirectional channels that have open-drain outputs. The bidirectional channels do not require a direction control input. A logic-low on one side causes the corresponding pin on the other side to be pulled low while avoiding data latching within the device. I/OA1 and I/OA2 outputs comprise special buffers that regulate the logic-low voltage at approximately 0.7V. The input logic-low threshold (V<sub>IL</sub>) of I/OA1 and I/OA2 is at least 50mV lower than the output logic-low voltage of I/OA1 and I/OA2. This prevents an output logic-low on side A from being accepted as an input low and subsequently transmitted to side B; thus, preventing a latching action. I/OB1 and I/OB2 are conventional outputs that do not regulate the logic-low output voltage.

Due to their nature, the A-side output buffers of the MAX14937 cannot be connected together, or to a device with similar buffers or rise-time accelerators. The B-side output buffers of the MAX14937, instead can be connected together, or to any other bidirectional buffer or level translator.

The I/OA1, I/OA2, I/OB1, and I/OB2 pins have open-drain outputs, requiring pullup resistors to their respective supplies for logic-high outputs. The output low voltages are guaranteed for sink currents of up to 30mA for side B, and 3mA for side A (see the [DC Electrical Characteristics](#) table). The device supports I<sup>2</sup>C clock stretching.

## Startup and Undervoltage Lockout

The V<sub>DDA</sub> and V<sub>DDB</sub> supplies are both internally monitored for undervoltage conditions. Undervoltage events can occur during power-up, power-down, or during normal operation due to a sagging supply voltage. When an undervoltage event is detected on either of the supplies, all bidirectional outputs become high-impedance and are pulled high by the external pullup resistor on the open-drain outputs ([Table 2](#)). [Figure 4](#) through [Figure 7](#) show the behavior of the outputs during power-up and power-down.

## Applications Information

### Effect of Continuous Isolation on Lifetime

High-voltage conditions cause insulation to degrade over time. Higher voltages result in faster degradation. Even the high-quality insulating material used in the device can degrade over long periods of time with a constant high voltage across the isolation barrier.

### Power-Supply Sequencing

The MAX14937 does not require special power-supply sequencing. The logic levels are set independently on either side by V<sub>DDA</sub> and V<sub>DDB</sub>. Each supply can be present over the entire specified range regardless of the level or presence of the other supply.

### Power-Supply Decoupling

To reduce ripple and the chance of introducing data errors, bypass V<sub>DDA</sub> and V<sub>DDB</sub> with 0.1µF ceramic capacitors to GNDA and GNDB, respectively. Place the bypass capacitors as close as possible to the power-supply input.

### Input/Output Capacitive Loads

For optimal performance, ensure that C<sub>LA</sub> ≤ 40pF and C<sub>LB</sub> ≤ 400pF (see [Figure 1](#)).

### Layout Considerations

The PCB designer should follow some critical recommendations in order to get the best performance from the design.

- Keep the input/output traces as short as possible. To keep signal paths low-inductance, avoid using vias.
- Have a solid ground plane underneath the high-speed signal layer.
- Keep the area underneath the MAX14937 free from ground and signal planes. Any galvanic or metallic connection between the Side A and Side B defeats the isolation.

**Table 2. Output Behavior During Undervoltage Conditions**

V <sub>DDA</sub>	V <sub>DDB</sub>	V <sub>I/OA_</sub>	V <sub>I/OB_</sub>
Powered	Powered	1	1
Powered	Powered	0	0
Undervoltage	Powered	High-Z	High-Z
Powered	Undervoltage	High-Z	High-Z

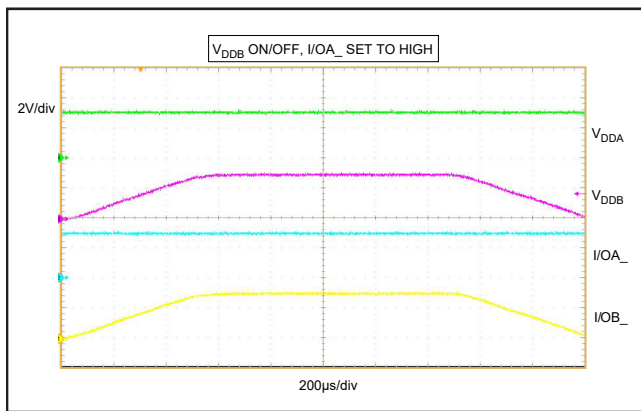

Figure 4. Undervoltage-Lockout Behavior (I/OB\_ Set High)

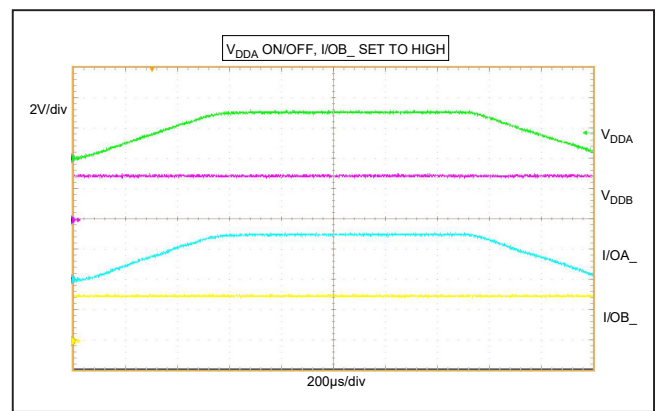

Figure 5. Undervoltage-Lockout Behavior (I/OA\_ Set High)

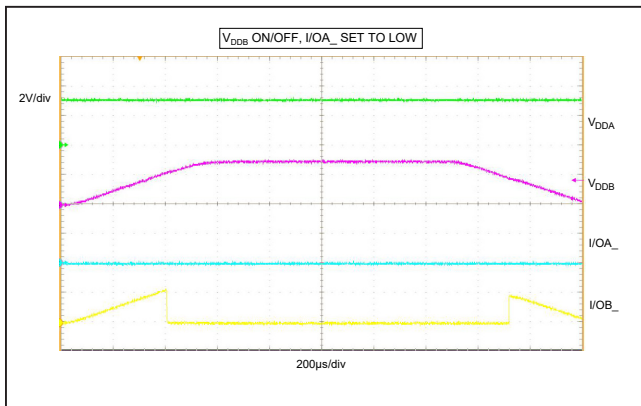

Figure 6. Undervoltage-Lockout Behavior (I/OB\_ Set Low)

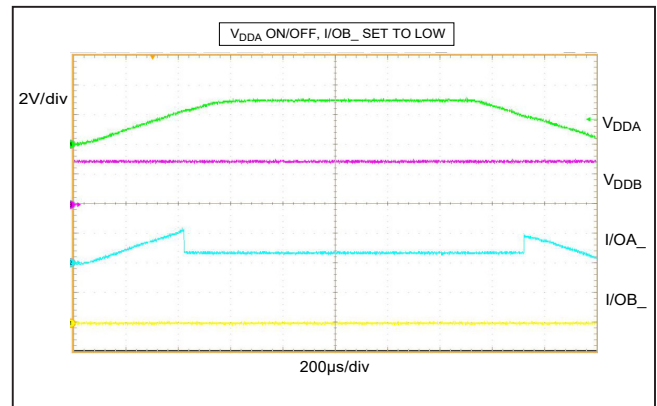

Figure 7. Undervoltage-Lockout Behavior (I/OA\_ Set Low)

### Ordering Information

PART	TEMP RANGE	PIN-PACKAGE
MAX14937AWE+	-40°C to +125°C	16 Wide SOIC

+Denotes a lead(Pb)-free/RoHS-compliant package.

### Chip Information

PROCESS: BiCMOS

## Revision History

REVISION NUMBER	REVISION DATE	DESCRIPTION	PAGES CHANGED
0	3/15	Initial release	—
1	5/16	Updated TUV information and added <i>IEC Insulation Testing</i> table	1, 6
2	1/17	Removed VDE pending	6
3	10/19	Updated <i>General Description</i> and replaced the <i>Bidirectional Channels</i> sections; corrected typos	1, 6, 12
4	11/20	Updated the <i>Safety Regulatory Approvals</i> , <i>Absolute Maximum Ratings</i> , <i>Dynamic Characteristics</i> , <i>Safety Regulatory Approvals</i> , <i>IEC Insulation Testing</i> , <i>Detailed Description</i> , and <i>Applications Information</i> sections; replaced the <i>Insulation Characteristics</i> table, <i>Figure 1</i> ; added <i>Figure 2</i> , <i>3</i> , and <i>Table 1</i> and renumbered subsequent Figures and Tables	1, 2, 4–8, 13, 14

For pricing, delivery, and ordering information, please visit Maxim Integrated's online storefront at <https://www.maximintegrated.com/en/storefront/storefront.html>.

Maxim Integrated cannot assume responsibility for use of any circuitry other than circuitry entirely embodied in a Maxim Integrated product. No circuit patent licenses are implied. Maxim Integrated reserves the right to change the circuitry and specifications without notice at any time. The parametric values (min and max limits) shown in the Electrical Characteristics table are guaranteed. Other parametric values quoted in this data sheet are provided for guidance.



# Mouser Electronics

Authorized Distributor

Click to View Pricing, Inventory, Delivery & Lifecycle Information:

[Maxim Integrated:](#)

[MAX14937AWE+](#) [MAX14937AWE+T](#)