

## 1A Driver Transistor Built-In, Multi Functional Step-Up DC/DC Converters

## ■ GENERAL DESCRIPTION

☆GreenOperation Compatible

XC9131 series are synchronous step-up DC/DC converters with a  $0.2\Omega$  (TYP.) N-channel driver transistor and a  $0.2\Omega$  (TYP.) synchronous P-channel switching transistor built-in. A highly efficient and stable current can be supplied up to 1.0A by reducing ON resistance of the built-in transistors.

The series are able to start operation under the condition which has 0.9V input voltage to generate 3.3V output voltage with a  $33\Omega$  load resistor, suitable for mobile equipment using only one Alkaline battery or one Nickel metal hydride battery.

During the operation of a shutdown, the load disconnection function enables to cut the current conduction path from the input to the output.

The series has  $0.5V$  ( $\pm 0.01V$ ) reference voltage integrated and being able to set an output voltage with external components.

## ■ APPLICATIONS

- Digital audio equipments
- Digital still cameras / Camcorders
- Computer mouses
- Multi-function power supplies

## ■ FEATURES

<b>Input Voltage Range</b>	: 0.65V~5.5V
<b>Output Voltage Range</b>	: 1.8V~5.0V ( $V_{FB}=0.50V\pm 0.01V$ Set up with external components)
<b>Oscillation Frequency</b>	: 1.2MHz ( $\pm 15\%$ )
<b>Input Current</b>	: 1.0A
<b>Output Current</b>	: 500mA @ $V_{OUT}=3.3V$ , $V_{IN}=1.8V$ (TYP.)
<b>Control Mode Selection</b>	: PWM or Auto PWM/PFM
<b>Load Transient Response</b>	: 100mV @ $V_{OUT}=3.3V$ , $V_{IN}=1.8V$ , $I_{OUT}=1mA \rightarrow 200mA$
<b>Protection Circuits</b>	: Thermal shutdown Over-current limit
<b>Functions</b>	: Soft-start Load Disconnection Function $C_L$ Auto Discharge Function Flag-out Function
<b>Output Capacitor</b>	: Ceramic Capacitor
<b>Operating Ambient Temperature</b>	: $-40^\circ C \sim +85^\circ C$
<b>Package</b>	: USP-10B
<b>Environmentally Friendly</b>	: EU RoHS Compliant, Pb Free

## ■ TYPICAL APPLICATION CIRCUIT

- XC9131 Series (FB)

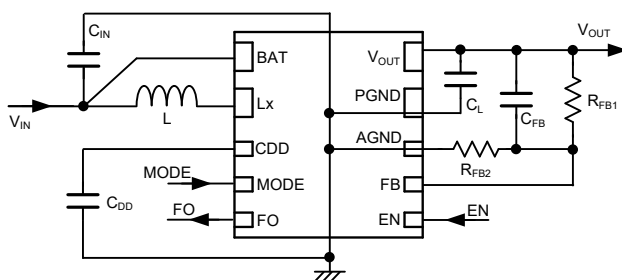

## ■ TYPICAL PERFORMANCE CHARACTERISTICS

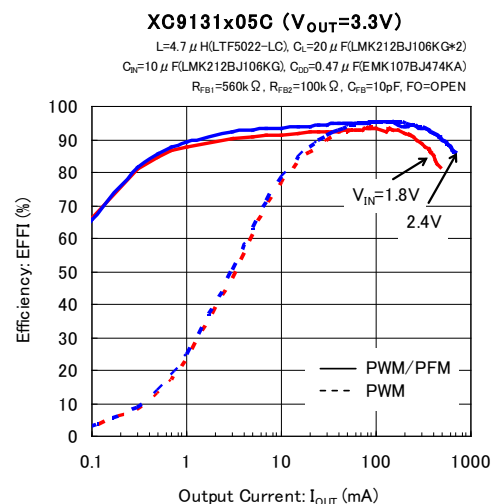

## PIN CONFIGURATION

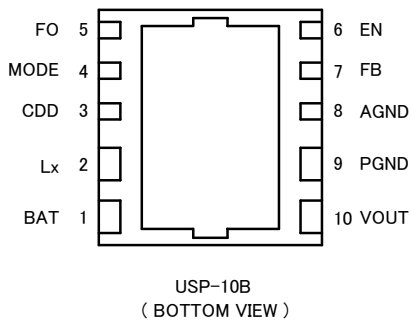

## PIN ASSIGNMENT

PIN NUMBER	PIN NAME	FUNCTIONS
1	BAT	Power Input
2	Lx	Switching
3	CDD	Bypass Capacitor Connection
4	MODE	Mode Switching
5	FO	Flag Output
6	EN	Enable
7	FB	Output Voltage Monitoring
8	AGND	Analog Ground
9	PGND	Power Ground
10	VOUT	Output Voltage

\* The dissipation pad for the USP-10B package should be solder-plated in recommended mount pattern and metal masking so as to enhance mounting strength and heat release.

If the pad needs to be connected to other pins, it should be connected to the AGND (No.8) or PGND (No.9) pin.

\*Please short the GND pins (pins 8 and 9).

## FUNCTION CHART

### 1. EN Pin Function

EN PIN	FUNCTIONS
H	Operation
L	Stop

\* Do not leave the EN pin open.

### 2. MODE Pin Function

MODE PIN	FUNCTIONS
H	PWM
L	PWM/PFM automatic control

\* Do not leave the MODE pin open.

## ■ PRODUCT CLASSIFICATION

### ● Ordering Information

XC9131①②③④⑤⑥-⑦<sup>(\*)</sup>

DESIGNATOR	ITEM	SYMBOL	DESCRIPTION
①	TYPE	F	With C <sub>L</sub> Auto Discharge V <sub>OUT</sub> pin can not be connected to the different output pin such as another supply (AC adaptor).
		H	Without C <sub>L</sub> Auto Discharge V <sub>OUT</sub> pin can be connected to the different output pin such as another supply (AC adaptor).
②③	Reference Voltage (FB)	05	Reference Voltage e.g. FB product, ②③=05 (Fixed)
④	Oscillation Frequency	C	1.2MHz
⑤⑥-⑦ <sup>(*)</sup>	Package (Order Unit)	DR-G	USP-10B (3,000/Reel)

<sup>(\*)</sup> The "-G" suffix denotes Halogen and Antimony free as well as being fully EU RoHS compliant.

## ■ BLOCK DIAGRAMS

### ●XC9131F Series

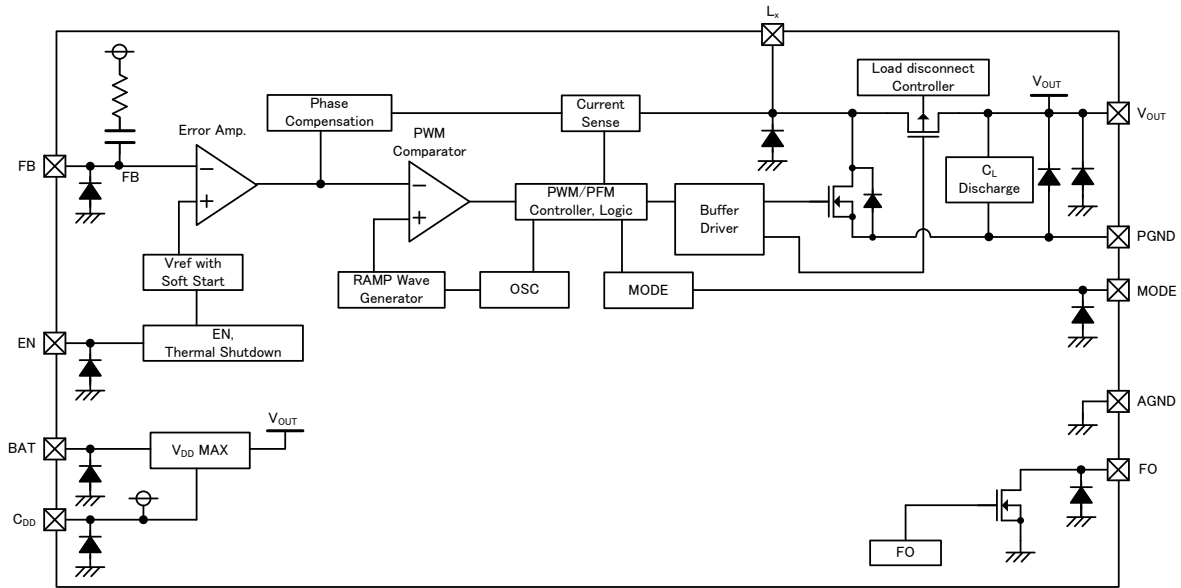

\* Diodes inside the circuit are an ESD protection diode and a parasitic diode.

### ●XC9131H Series

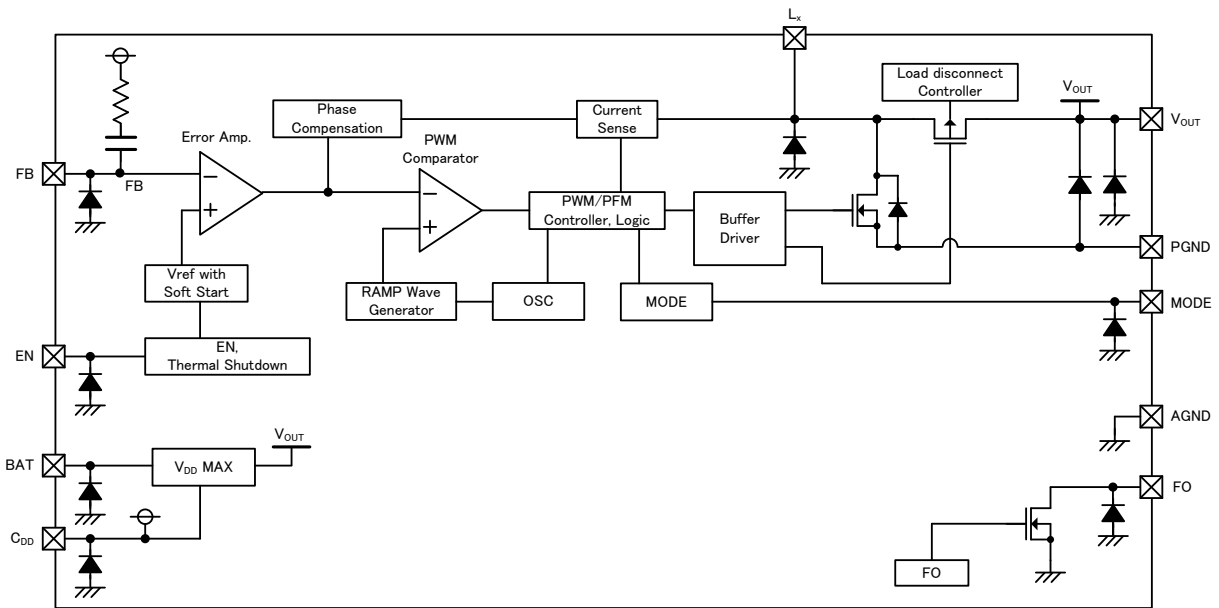

\* Diodes inside the circuit are an ESD protection diode and a parasitic diode.

## ■ ABSOLUTE MAXIMUM RATINGS

Ta=25°C

PARAMETER	SYMBOL	RATINGS	UNITS
V <sub>OUT</sub> Pin Voltage	V <sub>OUT</sub>	-0.3~7.0	V
C <sub>DD</sub> Pin Voltage	V <sub>CDD</sub>	-0.3~7.0	V
FO Pin Voltage	V <sub>FO</sub>	-0.3~7.0	V
FO Pin Current	I <sub>FO</sub>	10	mA
FB Pin Voltage	V <sub>FB</sub>	-0.3~7.0	V
BAT Pin Voltage	V <sub>BAT</sub>	-0.3~7.0	V
MODE Pin Voltage	V <sub>MODE</sub>	-0.3~7.0	V
EN Pin Voltage	V <sub>EN</sub>	-0.3~7.0	V
Lx Pin Voltage	V <sub>Lx</sub>	-0.3~V <sub>OUT</sub> +0.3	V
Lx Pin Current	I <sub>Lx</sub>	±2000	mA
Power Dissipation	USP-10B	Pd	150
Operating Ambient Temperature	T <sub>opr</sub>	-40 ~ +85	°C
Storage Temperature	T <sub>stg</sub>	-55 ~ +125	°C

\* AGND and PGND are standard voltage for all of the voltage.

## ELECTRICAL CHARACTERISTICS

●XC9131F05C / XC9131H05C

Ta=25°C

PARAMETER	SYMBOL	CONDITIONS	MIN.	TYP.	MAX.	UNITS	CIRCUIT
Input Voltage	V <sub>IN</sub>		-	-	5.5	V	
FB Voltage	V <sub>FB</sub>	V <sub>OUT</sub> =3.3V, V <sub>MODE</sub> =0V Voltage to start oscillation while V <sub>FB</sub> =0.511V→0.49V	0.490	0.500	0.510	V	⑤
Output Voltage Setting Range	V <sub>OUTSET</sub>		1.8	-	5.0	V	①
Operation Start Voltage	V <sub>ST1</sub>	R <sub>L</sub> =1kΩ, V <sub>MODE</sub> =0V	-	-	0.85	V	①
		R <sub>L</sub> =33Ω, V <sub>MODE</sub> =0V	-	-	0.9 (*)	V	①
Operation Hold Voltage	V <sub>HLD</sub>	R <sub>L</sub> =1kΩ, V <sub>MODE</sub> =0V	-	0.65	-	V	①
Supply Current	I <sub>q</sub>	V <sub>FB</sub> =0.5V×1.1 (oscillation stops)	-	36	50	μA	②
Input Pin Current	I <sub>BAT</sub>	V <sub>IN</sub> =1.8V, V <sub>EN</sub> =3.3V, V <sub>FB</sub> =0.5V×1.1	-	0.65	2.0	μA	⑥
Stand-by Current (XC9131F)	I <sub>STB</sub>	V <sub>IN</sub> =V <sub>Lx</sub> =3.3V	-	0.10	2.0	μA	③
Stand-by Current (XC9131H)			-	0.90	5.0		
Lx Leakage Current	I <sub>LxL</sub>	V <sub>IN</sub> =V <sub>Lx</sub> =3.3V	-	0.1	2.0	μA	④
Oscillation Frequency	f <sub>OSC</sub>	V <sub>FB</sub> =0.5V×0.9	1.02	1.20	1.38	MHz	⑤
Maximum Duty Cycle	D <sub>MAX</sub>	V <sub>FB</sub> =0.5V×0.9	88	93	97	%	⑤
Minimum Duty Cycle	D <sub>MIN</sub>	V <sub>FB</sub> =0.5V×1.1	-	-	0	%	⑤
PFM Switching Current	I <sub>PFM</sub>	V <sub>MODE</sub> =0V, R <sub>L</sub> =330Ω	-	250	350	mA	①
Efficiency (*2)	EFFI	I <sub>OUT</sub> =100mA, L=4.7μH(LTF5022-LC), C <sub>FB</sub> =10pF	-	93	-	%	①
LX SW "Pch" ON Resistance	R <sub>LxP</sub>	V <sub>Lx</sub> =3.3V, V <sub>FB</sub> =0.5V×1.1, I <sub>OUT</sub> =200mA (*3)	-	0.20	0.35(*)	Ω	⑧
LX SW "Nch" ON Resistance	R <sub>LxN</sub>	V <sub>FB</sub> =0.5V×0.9 (*4)	-	0.20(*)	0.35(*)	Ω	⑨
Maximum Current Limit	I <sub>LIM</sub>	V <sub>OUT</sub> >2.5V (*7)	1.2	1.5	2.0	A	①
Soft-Start Time	t <sub>SS</sub>	V <sub>IN</sub> =3.3V, V <sub>FB</sub> =0.5V×0.95 Time to start oscillation while V <sub>EN</sub> =0V→V <sub>IN</sub>	2.8	5.0	8.0	ms	⑤
Thermal Shut Temperature	T <sub>TSD</sub>		-	150	-	°C	
Hysteresis Width	T <sub>HYS</sub>		-	20	-	°C	
C <sub>L</sub> Discharge Resistance (XC9131F)	R <sub>DCHG</sub>	V <sub>IN</sub> =V <sub>OUT</sub> =2.0V (*5)	100	200	400	Ω	⑥
FO ON Resistance	R <sub>FO</sub>	V <sub>EN</sub> =3.3V, V <sub>FO</sub> =0.5V (*6)	100	150	200	Ω	⑦
FO Leakage Current	I <sub>FO_LEAK</sub>	V <sub>FO</sub> =5.5V	-	0	1	μA	⑦
EN "H" Voltage	V <sub>ENH</sub>	V <sub>IN</sub> =3.3V, V <sub>FB</sub> =0.5V×0.9 Voltage to start oscillation while V <sub>EN</sub> =0.2V→0.75V	0.75	-	5.5	V	⑤
EN "L" Voltage	V <sub>ENL</sub>	V <sub>IN</sub> =3.3V, V <sub>FB</sub> =0.5V×0.9 Voltage to stop oscillation while V <sub>EN</sub> =0.75V→0.2V	AGND	-	0.2	V	⑤

## ■ ELECTRICAL CHARACTERISTICS (Continued)

● XC9131F05C / XC9131H05C (Continued)

PARAMETER	SYMBOL	CONDITIONS	MIN.	TYP.	MAX.	UNITS	CIRCUIT
MODE "H" Voltage	$V_{MODEH}$	$R_L=330\ \Omega$ , Voltage operates at PWM control	0.75	-	5.5	V	①
MODE "L" Voltage	$V_{MODEL}$	$R_L=330\ \Omega$ , Voltage operates at PFM control	AGND	-	0.2	V	①
EN "H" Current	$I_{ENH}$	$V_{IN}=V_{OUT}=V_{FB}=V_{EN}=5.5V$	-	-	0.1	$\mu A$	②
EN "L" Current	$I_{ENL}$	$V_{IN}=V_{OUT}=V_{FB}=5.5V, V_{EN}=0V$	-0.1	-	-	$\mu A$	②
MODE "H" Current	$I_{MODEH}$	$V_{IN}=V_{OUT}=V_{FB}=V_{EN}=V_{MODE}=5.5V$	-	-	0.1	$\mu A$	②
MODE "L" Current	$I_{MODEL}$	$V_{IN}=V_{OUT}=V_{FB}=V_{EN}=5.5V, V_{MODE}=0V$	-0.1	-	-	$\mu A$	②
FB "H" Current	$I_{FBH}$	$V_{IN}=V_{OUT}=V_{EN}=V_{FB}=5.5V$	-	-	0.1	$\mu A$	②
FB "L" Current	$I_{FBL}$	$V_{IN}=V_{OUT}=V_{EN}=5.5V, V_{FB}=0V$	-0.1	-	-	$\mu A$	②

External Components:  $C_{IN}=10\ \mu F$ (ceramic),  $L=2.2\ \mu H$ (VLCF4020 TDK),  $C_{DD}=0.47\ \mu F$ (ceramic),  $R_{FB1}=560k\ \Omega$ ,  $R_{FB2}=100k\ \Omega$   
 $C_{IN}=22\ \mu F$ (ceramic),  $C_{FB}=0pF$

Test Conditions:

For the Circuit No.1, unless otherwise stated,  $V_{IN}=1.8V$ ,  $V_{EN}=V_{MODE}=3.3V$

For the Circuit No.2, unless otherwise stated,  $V_{IN}=V_{OUT}=V_{EN}=3.3V$ ,  $V_{MODE}=0V$  (GND connected)

For the Circuit No.3, unless otherwise stated,  $V_{OUT}=V_{EN}=V_{MODE}=V_{FB}=0V$  (GND connected)

For the Circuit No.4, unless otherwise stated,  $V_{OUT}=V_{EN}=V_{MODE}=V_{FB}=0V$  (GND connected)

For the Circuit No.5, unless otherwise stated,  $V_{IN}=0.9V$ ,  $V_{OUT}=V_{EN}=V_{MODE}=V_{PULL}=3.3V$

For the Circuit No.6, unless otherwise stated,  $V_{OUT}=3.3V$ ,  $V_{EN}=V_{MODE}=V_{FB}=0V$  (GND connected)

For the Circuit No.7, unless otherwise stated,  $V_{IN}=V_{OUT}=V_{FB}=3.3V$ ,  $V_{EN}=V_{MODE}=0V$  (GND connected)

For the Circuit No.8, unless otherwise stated,  $V_{IN}=V_{EN}=V_{MODE}=3.3V$

For the Circuit No.9, unless otherwise stated,  $V_{IN}=V_{OUT}=V_{EN}=3.3V, V_{FB}=V_{MODE}=0V$  (GND connected)

NOTE:

\*1 : Designed value

\*2 : Efficiency =  $\{(output\ voltage) \times (output\ current)\} \div \{(input\ voltage) \times (input\ current)\} \times 100$

\*3 :  $L_x$  SW "P-ch" ON resistance =  $(V_{Lx}-V_{OUT\ pin\ test\ voltage}) \div 200mA$

\*4 : Testing method of  $L_x$  SW "N-ch" ON resistance is stated at test circuits.

\*5 :  $C_L$  Discharge resistance =  $V_{OUT} \div V_{OUT\ pin\ measure\ current}$

\*6 : FO ON resistance =  $V_{FO} \div FO\ pin\ measure\ current$

\*7 : When the output voltage is lower than 2.5V, the maximum current limit may become low.

## TYPICAL APPLICATION CIRCUIT

### ●XC9131 Series

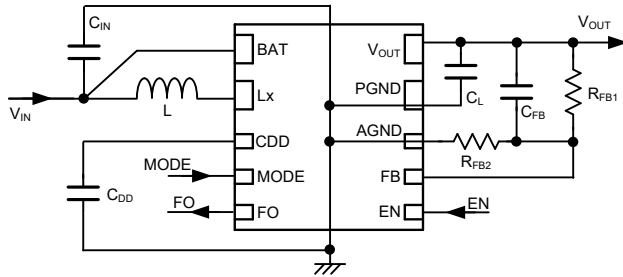

### <XC9131 Series Output Voltage Setting>

Output voltage can be set by adding external split resistors. Output voltage is determined by the following equation, based on the values of  $R_{FB1}$  and  $R_{FB2}$ . The sum of  $R_{FB1}$  and  $R_{FB2}$  should normally be 1000k $\Omega$  or less.

$$V_{OUT} = 0.5 \times (R_{FB1} + R_{FB2}) / R_{FB2}$$

The value of  $C_{FB}$ , speed-up capacitor for phase compensation, should be 0pF or  $f_{zfb} = 1 / (2 \pi \times C_{FB} \times R_{FB1})$  which is higher than 20 kHz. Also, when the input voltage,  $V_{IN}$  is lower than 1.5V,  $C_{FB}$  is 0pF. Adjustments are depending on application, inductance (L), load capacitance ( $C_L$ ) and dropout voltage.

### [Example of calculation]

When  $R_{FB1} = 560k\Omega$ ,  $R_{FB2} = 100k\Omega$ ,  $V_{OUT} = 0.5 \times (560k + 100k) / 100k = 3.3V$

When  $C_{FB} = 10pF$ ,  $f_{zfb} = 1 / (2 \pi \times 10p \times 560k) = 28.42kHz$

### [Typical example]

$V_{OUT}$ (V)	$R_{FB1}$ (k $\Omega$ )	$R_{FB2}$ (k $\Omega$ )	$C_{FB}$ (pF)
1.8	390	150	0
3.3	560	100	10
5.0	270	30	15

### [External Components]

$f_{OSC} = 1.2MHz$

L: 2.2  $\mu H$  ~ 4.7  $\mu H$

VLCF4020 series, LTF5022-LC series

$C_L$ : Should be selected in 20  $\mu F$  or higher

Capacitor JMK212BJ106KG  $\times 2$ , LMK212BJ106KG  $\times 2$ , LMK316BJ226ML is recommended.

Ceramic capacitor: B (JIS standard) or X7R, X5R (EIA standard)

$C_{IN}$ : 10  $\mu F$

Capacitor JMK212BJ106KG or LMK212BJ106KG is recommended.

Ceramic capacitor: B (JIS standard) or X7R, X5R (EIA standard)

$C_{DD}$ : 0.47  $\mu F$  (Ceramic capacitor)

\*  $V_{DD}$  voltage is constantly applied to the  $C_{DD}$  capacitor. While selecting a part, please concern about capacitance reduction and voltage durability.

\* For the coil L, please use 2.2  $\mu H$  to 4.7  $\mu H$ . However, when the input voltage  $V_{IN}$  is lower than 1.5V, please use 2.2  $\mu H$ .

\* Capacitance  $C_L$  is recommended 20  $\mu F$  or higher. (Ceramic capacitor compatible)

When you select the external components, please consider capacitance loss and voltage durability.

\* If using tantalum or low ESR electrolytic capacitors please be aware that ripple voltage will be higher due to the larger ESR (Equivalent Series Resistance) values of those types of capacitors. Please also note that the IC's operation may become unstable with such capacitors so that we recommend to test on the board before usage.

\* If using electrolytic capacitor for the  $C_L$ , please connect a ceramic capacitor in parallel.



## OPERATIONAL EXPLANATION

The XC9131 series consists of a reference voltage source, ramp wave circuit, error amplifier, PWM comparator, phase compensation circuit, N-channel driver transistor, P-channel synchronous rectification switching transistor and current limiter circuit.

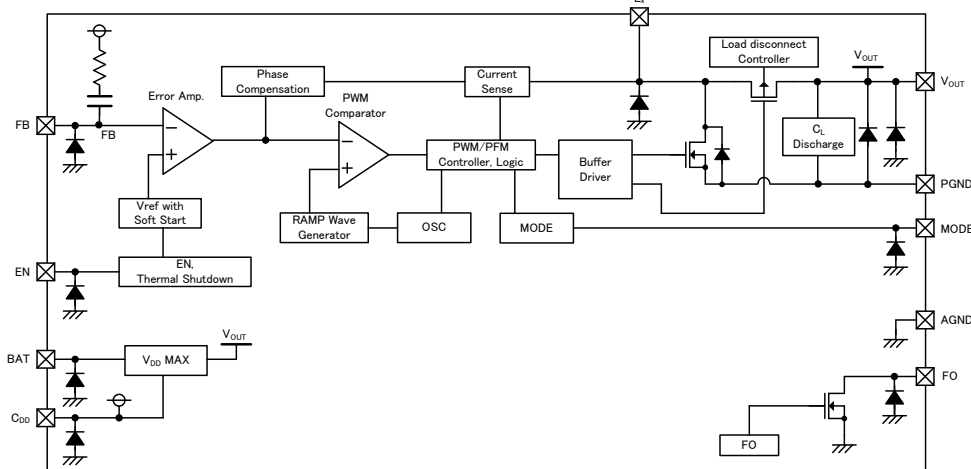

The XC9131 series has FB pin for external components  $R_{FB1}$  and  $R_{FB2}$ . The error amplifier compares the internal reference voltage with the FB pin feed back voltage via resistors  $R_{FB1}$  and  $R_{FB2}$ . Phase compensation is performed on the resulting error amplifier output, to input a signal to the PWM comparator to determine the turn-on time of the N-channel driver transistor during PWM operation. The PWM comparator compares, in terms of voltage level, the signal from the error amplifier with the ramp wave from the ramp wave circuit, and delivers the resulting output to the buffer driver circuit to cause the Lx pin to output a switching duty cycle. This process is continuously performed to ensure stable output voltage. The current feedback circuit monitors the N-channel driver transistor's turn-on current for each switching operation, and modulates the error amplifier output signal to provide multiple feedback signals. This enables a stable feedback loop even when a low ESR capacitor, such as a ceramic capacitor, is used, ensuring stable output voltage.

### <Reference Voltage Source>

The source provides the reference voltage to ensure stable output of the DC/DC converter.

### <Ramp Wave Circuit>

The ramp wave circuit determines switching frequency. The frequency is fixed internally at 1.2MHz. The Clock generated is used to produce ramp waveforms needed for PWM operation, and to synchronize all the internal circuits.

### <Error Amplifier>

The error amplifier is designed to monitor output voltage. The amplifier compares the reference voltage with the feedback voltage divided by the internal resistors ( $R_{FB1}$  and  $R_{FB2}$ ). When the FB pin is lower than the reference voltage, output voltage of the error amplifier increases. The gain and frequency characteristics of the error amplifier are optimized internally.

### < Maximum Current Limit>

The current limiter circuit monitors the maximum current flowing through the N-channel driver transistor connected to the Lx pin.

- ① When the driver current is greater than a specific level (equivalent to peak coil current), the maximum current limit function starts to operate and the pulses from the Lx pin turn off the N-channel driver transistor at any given time.
- ② When the driver transistor is turned off, the limiter circuit is then released from the maximum current limit detection state.
- ③ At the next pulse, the driver transistor is turned on. However, the transistor is immediately turned off in the case of an over current state.
- ④ When the over current state is eliminated, the IC resumes its normal operation.

The XC9131 series does not have this latch function, so operation steps ① through ③ repeat until the over current state ends. Please note that the current flow into the N-channel driver transistor is different from output current  $I_{OUT}$ .

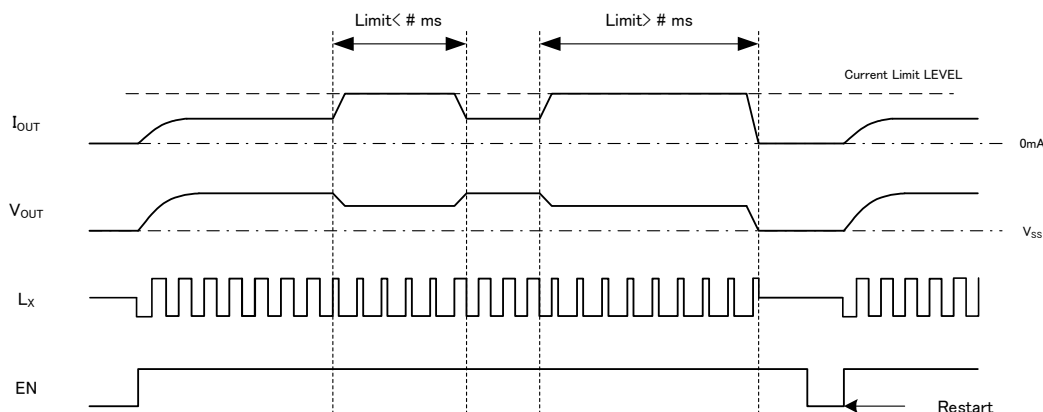

## OPERATIONAL EXPLANATION (Continued)

### <Thermal Shutdown>

For protection against heat damage, the thermal shutdown function monitors chip temperature. When the chip's temperature reaches 150°C (TYP.), the thermal shutdown circuit starts operating and the driver transistor will be turned off. At the same time, the output voltage decreases. When the temperature drops to 130°C (TYP.) after shutting off the current flow, the IC performs the soft start function to initiate output startup operation.

### <MODE>

The MODE pin operates in PWM mode by applying a high level voltage and in PFM/PWM automatic switching mode by applying a low level voltage.

### <Shut-Down, Load Disconnection Function>

The IC enters chip disable state by applying low level voltage to the EN pin. At this time, the N-channel and P-channel synchronous switching transistors are turned OFF. Please also note that a parasitic diode of the P-channel synchronous switch is controlled, thus, the current conduction path is disconnected.

### <Flag Out>

The FO pin becomes high impedance during over current state, over temperature state, soft-start period, and shut-down period. In normal state, the FO pin is low impedance. The FO pin is N-channel open drain output.

### <CL Discharge >

XC9131F series can discharge the electric charge at the output capacitor (C<sub>L</sub>) when a low signal to the EN pin which enables a whole IC circuit put into OFF state, is inputted via the N-channel transistor located between the V<sub>OUT</sub> pin and the P<sub>GND</sub> pin. When the IC is disabled, electric charge at the output capacitor (C<sub>L</sub>) is quickly discharged so that it may avoid application malfunction. Discharge time of the output capacitor (C<sub>L</sub>) is set by the C<sub>L</sub> auto-discharge resistance (R) and the output capacitor (C<sub>L</sub>). By setting time constant of a C<sub>L</sub> auto-discharge resistance value [R<sub>DCHG</sub>] and an output capacitor value (C<sub>L</sub>) as  $\tau$  ( $\tau = C \times R$ ), discharge time of the output voltage after discharge via the N channel transistor is calculated by the following formulas. However, the C<sub>L</sub> discharge resistance [R<sub>DCHG</sub>] is depends on the V<sub>BAT</sub> or V<sub>OUT</sub>, so it is difficult to make sure the discharge time. We recommend that you fully check actual performance.

$$V = V_{OUT} \times e^{-t/\tau} \text{ or } t = \tau \ln(V_{OUT}/V)$$

V : Output voltage after discharge

V<sub>OUT</sub> : Output voltage

t : Discharge time

$\tau$  : C × R

C : Capacitance of Output capacitor (C<sub>L</sub>)

R : C<sub>L</sub> Discharge resistance, it depends on supply voltage

### ● Output Voltage Discharge Characteristics

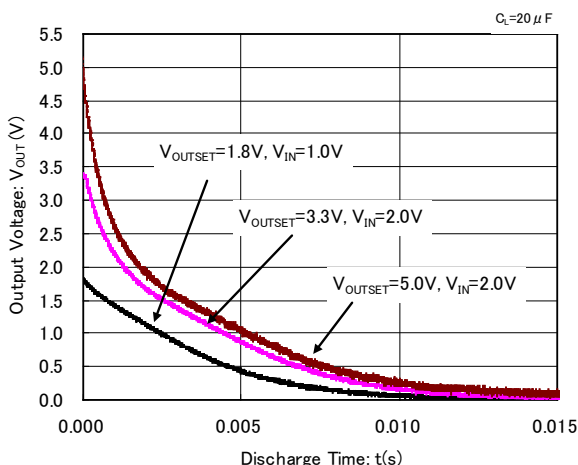

The XC9131H series do not have C<sub>L</sub> discharge function. If the MODE pin is set low to select auto PWM/PFM mode, the output of XC9131H series can be connected to another power supply.

However, it should be noted that when the output of XC9131F series is connected to another power supply, the IC may be damaged.

### < C<sub>DD</sub>, V<sub>DD</sub>MAX >

V<sub>DD</sub> MAX circuit compares the input voltage and the output voltage then it will select the higher one as the power supply for the IC. The higher voltage will be supplied to the C<sub>DD</sub> pin and the IC operates in stable when a capacitor is connected.

## NOTE ON USE

1. Please do not exceed the stated absolute maximum ratings values.
2. The DC/DC converter performance is greatly influenced by not only the ICs' characteristics, but also by those of the external components. Care must be taken when selecting the external components. Especially for  $C_L$  load capacitor, it is recommended to use type B capacitors (JIS regulation) or X7R, X5R capacitors (EIA regulation).
3. Make sure that the PCB GND traces are as thick and wide as possible. The ground voltage fluctuation caused by high ground current at the time of switching may result in instability of the IC. Therefore, the GND traces close to PGND pin and AGND pin are important.
4. Please mount each external component as close to the IC as possible. Also, please make traces thick and short to reduce the circuit impedance.
5. When the device is used in high step-up ratio, the current limit function may not work during excessive load current. In this case, the maximum duty cycle limits maximum current.
6. In case of connecting to another power supply as shown in below circuit diagram, please use the XC9131H series. Please also note that the MODE pin is fixed in low level for selecting PWM/PFM auto mode. If the MODE pin is in high to maintain fixed PWM control mode, the backflow current may happen. If the output of XC9131F series is connected to another power supply, the IC may be damaged.

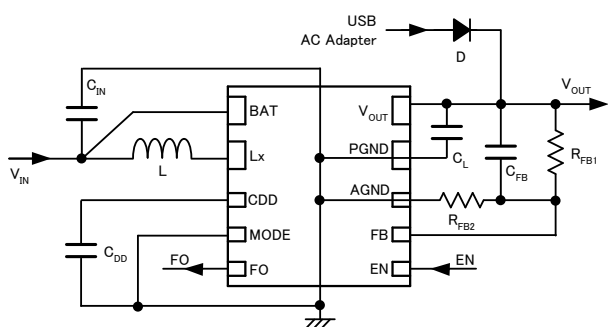

7. The maximum current limiter controls the limit of the N-channel driver transistor by monitoring current flow. This function does not limit the current flow of the P-channel synchronous transistor. When over current flows to the P-channel synchronous transistor in case of load, the IC may be damaged.
8. The MODE pin and EN pin are not pulled-down internally. Please make sure that the voltage applied to the MODE pin and the EN pin.
9. When used in small step-up ratios, the device may skip pulses during PWM control mode.
10. In the PWM/PFM auto, transition from PFM to PWM mode, or PWM to PFM mode, the output voltage may be fluctuated. (Please refer below)

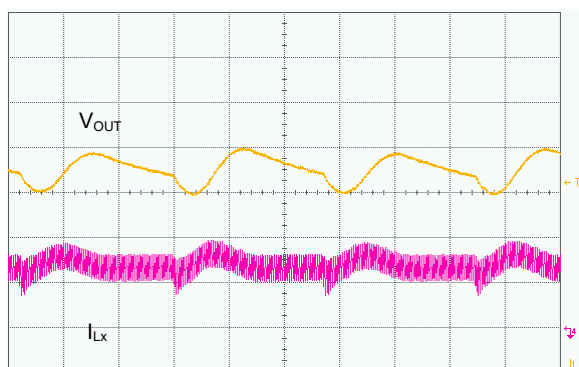

$V_{IN}=4.2V$ ,  $V_{OUT}=5.0V$ , MODE: Auto PWM/PFM  
 $V_{OUT}$ :50mV/div,  $I_{LX}$ :200mA/div, Time:20  $\mu$ s/div  
 $L=4.7 \mu$ H(LTF5022-LC),  $C_L=20 \mu$ F(LMK212BJ106KG\*2)  
 $C_{IN}=10 \mu$ F(LMK212BJ106KG),  $C_{DD}=0.47 \mu$ F(EMK107BJ474KA-T)  
 $R_{FB1}=270k\Omega$ ,  $R_{FB2}=30k\Omega$ ,  $C_{FB}=10pF$

## NOTE ON USE (Continued)

- When used in large step-up ratios and small load current, the output voltage may change when PWM/PFM auto is changed to PWM control mode by using the MODE pin. (Please refer below)

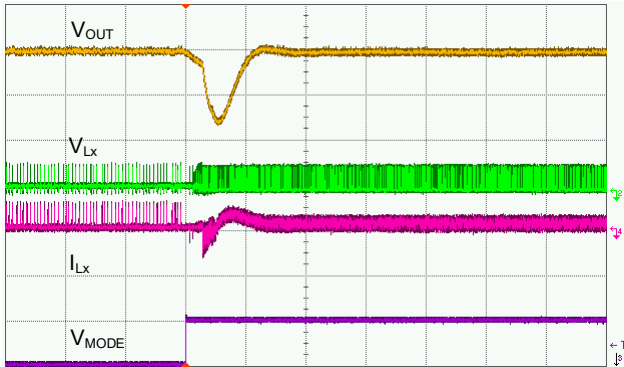

$V_{IN}=0.9V$ ,  $V_{OUT}=5.0V$ , MODE:PWM/PFM→PWM,  $I_{OUT}=3mA$   
 $V_{OUT}:100mV/div$ ,  $I_{Lx}:500mA/div$ ,  $V_{Lx}:10V/div$ ,  $V_{MODE}:5V/div$ , Time:200μs/div  
 $L=2.2μH$ (VLFCF4020),  $C_L=20μF$ (LMK212BJ106KG\*2)  
 $C_{IN}=10μF$ (LMK212BJ106KG),  $C_{DB}=0.47μF$ (EMK107BJ474KA-T)  
 $R_{FB1}=270kΩ$ ,  $R_{FB2}=30kΩ$ ,  $C_{FB}=0pF$

- After the soft-start period, when used in  $V_{IN} > V_{OUTSET}$  (the input voltage is higher than the output voltage), In the XC9131H series, the P-channel synchronous transistor is turned on when MODE pin is tied to high. When the MODE pin is tied to low, the current flows into the parasitic diode of the P-channel synchronous transistor so that results in generating excessive heat in the IC. Please test in the board before usage with considering heat dissipation. For the XC9131F series the P-channel synchronous transistor is always turned on which is no matter of MODE pin control.
- During start-up, when output setting voltage is lower than 2V, the PWM/PFM auto mode should be selected. In case of the fixed PWM control mode, the output voltage may become smaller than the setting voltage. When the setting output voltage is higher than 2V, the IC can be started to operate in the both modes of PWM/PFM auto and fixed PWM control.
- For temporary, transitional voltage drop or voltage rising phenomenon, the IC is liable to malfunction should the ratings be exceeded.
- Torex places an importance on improving our products and its reliability. However, by any possibility, we would request user fail-safe design and post-aging treatment on system or equipment.

## ■NOTE ON USE (Continued)

### ●Instructions for pattern layouts

1. In order to stabilize  $V_{IN}$  voltage level, we recommend that a by-pass capacitor  $C_{IN}$  is connected as close as possible to the  $V_{IN}$  and  $V_{SS}$  pins.
2. Please mount each external component as close to the IC as possible.
3. Place external components as close to the IC as possible and use thick and short traces to reduce the circuit impedance.
4. Make sure that the PCB GND traces are thick and wide as possible. Ground voltage level fluctuation created by high ground current at the time of switching may cause instability of the IC.
5. The internal driver transistors bring on heat because of the  $I_{IN}$  current and ON resistance of the driver transistors.

### ●Example of pattern layout

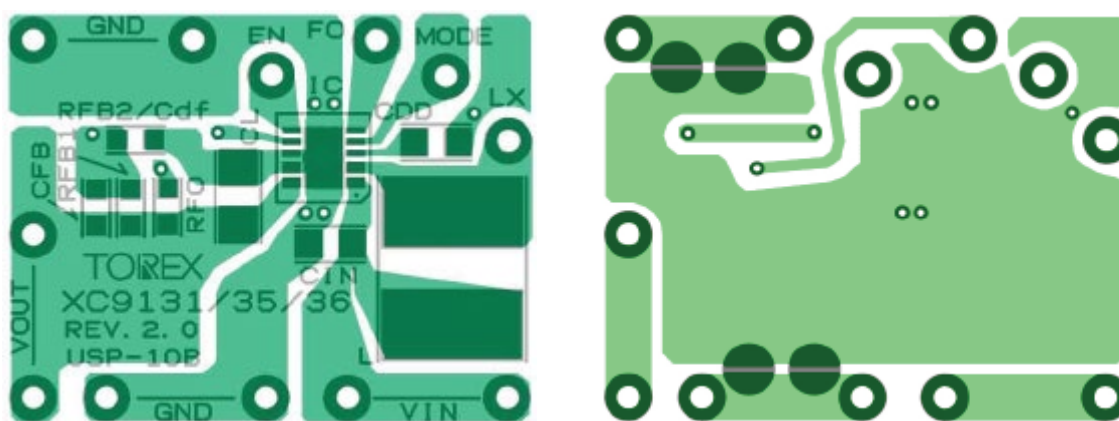

FRONT

BACK

## TEST CIRCUITS

< Circuit No.1 >

XC9131F/H

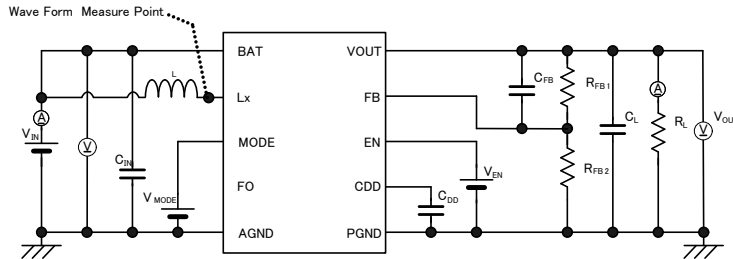

※ External Components  
 L : 2.2  $\mu$ H (VLCF 4020-2R2:TDK)  
 $C_{IN}$  : 10  $\mu$ F (ceramic)  
 $C_{DD}$  : 0.47  $\mu$ F (ceramic)  
 $C_L$  : 22  $\mu$ F (ceramic)  
 $C_{FB}$  : 0 pF  
 $R_{FB1}$  : 560k  $\Omega$   
 $R_{FB2}$  : 100k  $\Omega$

< Circuit No.2 >

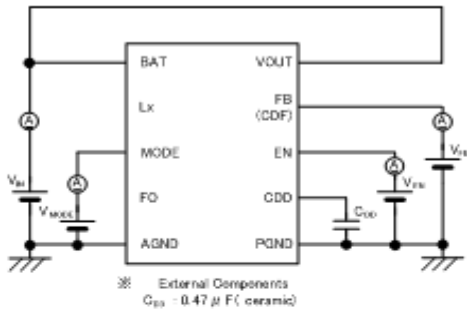

< Circuit No.3 >

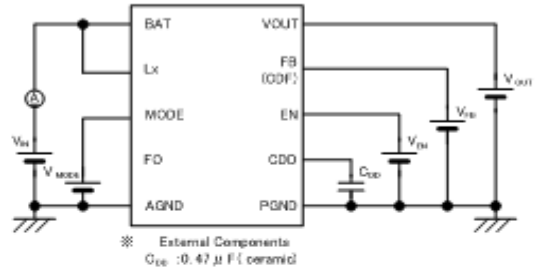

< Circuit No.4 >

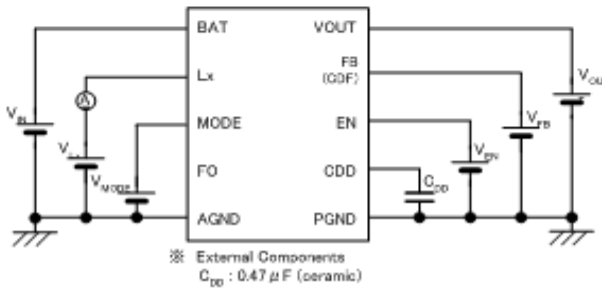

## TEST CIRCUITS

< Circuit No.5 >

XC9131F/H

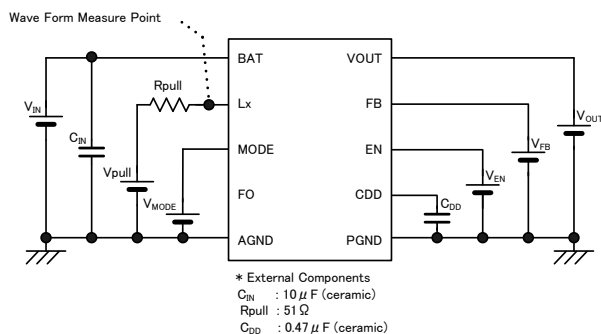

< Circuit No.6 >

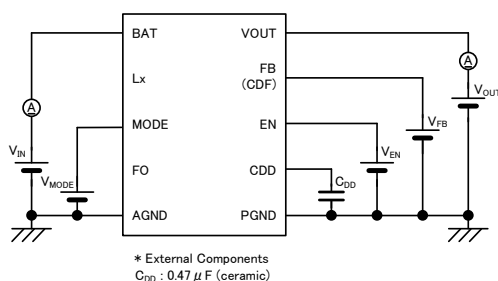

< Circuit No.7 >

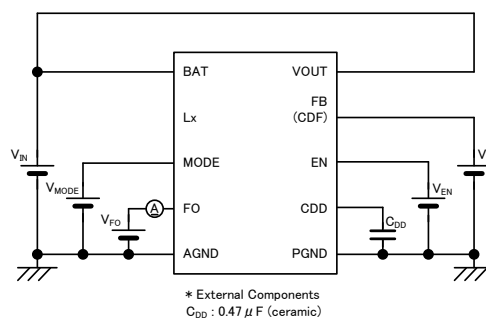

< Circuit No.8 >

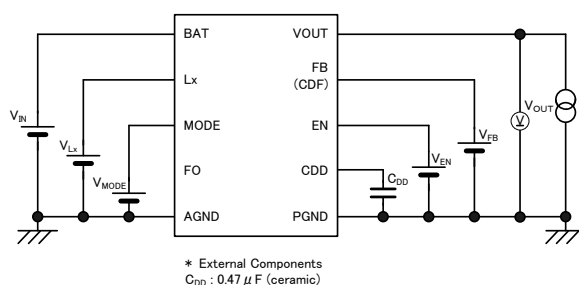

< Circuit No.9 >

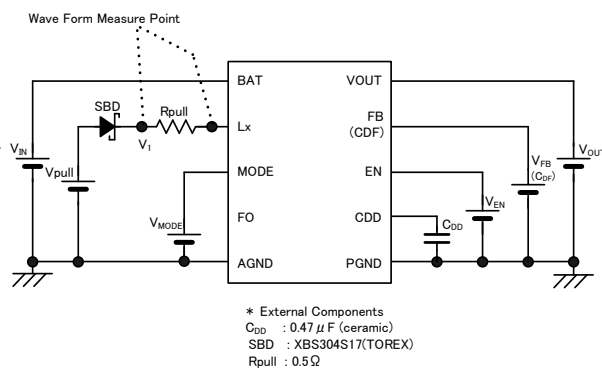

<Measurement method for ON resistance of the Lx switch>

Using the layout of circuit No.9 above, set the Lx pin voltage to 50mV by adjusting the Vpull voltage whilst the N-channel driver transistor is turned on. Then, measure the voltage difference between both ends of Rpull. ON Resistance is calculated by using the following formula:

$$R_{LxN} = 0.05 \div ((V1 - 0.05) \div 0.5)$$

where V1 is a node voltage between SBD and Rpull. Lx pin voltage and V1 are measured by an oscilloscope.

## TYPICAL PERFORMANCE CHARACTERISTICS

### (1) Efficiency vs. Output Current

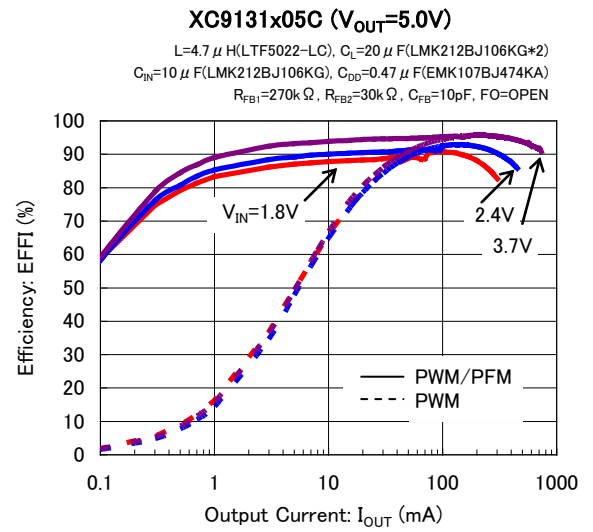
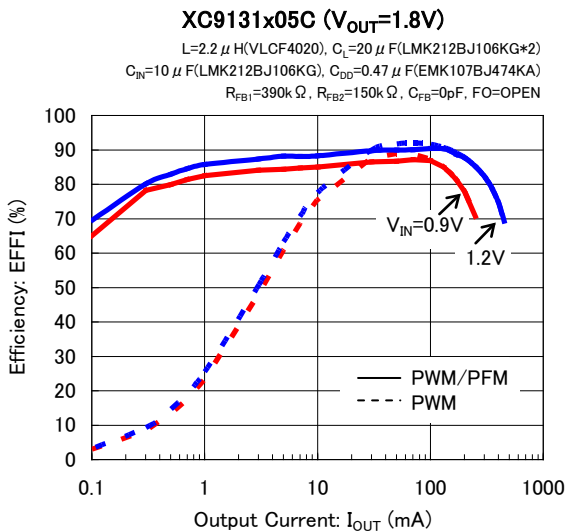
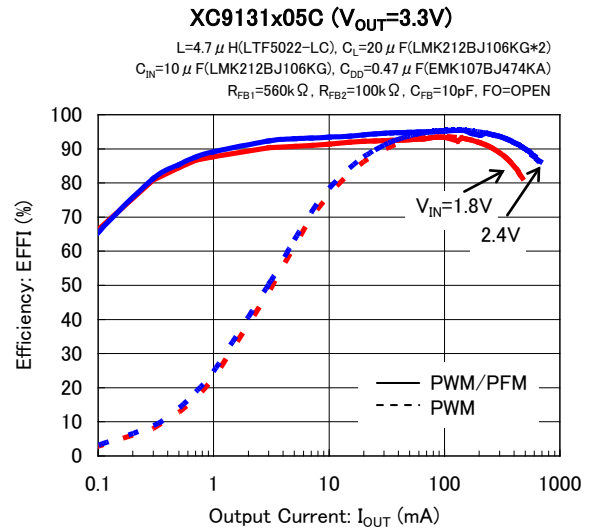
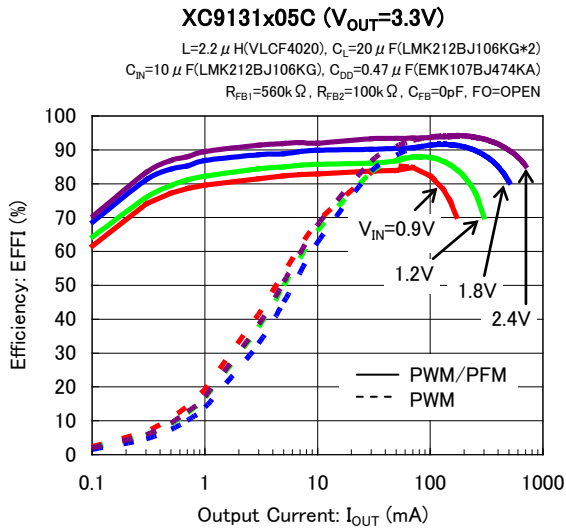

### (2) Output Voltage vs. Output Current

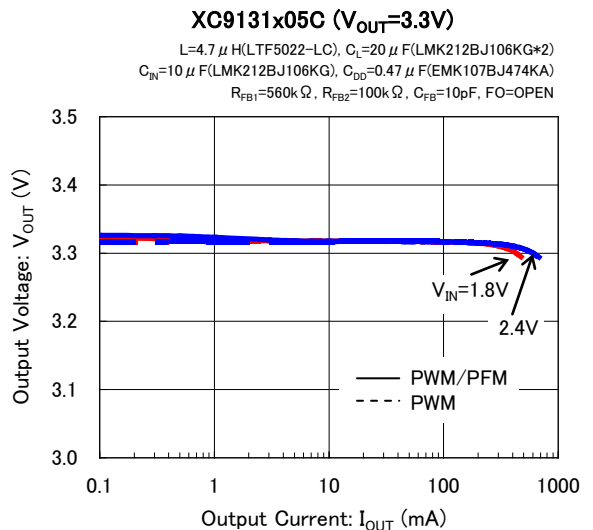
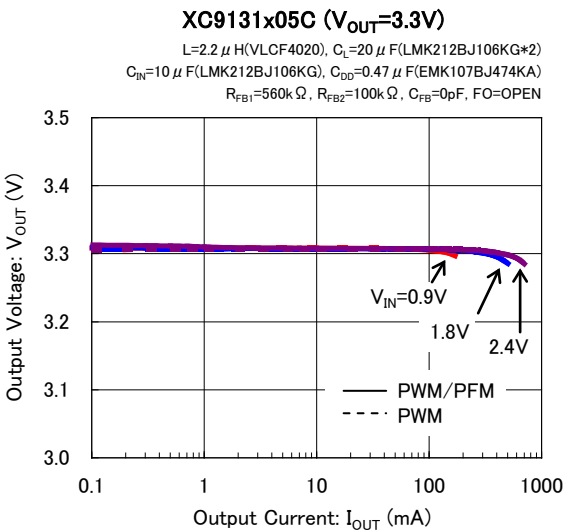



## TYPICAL PERFORMANCE CHARACTERISTICS (Continued)

### (2) Output Voltage vs. Output Current (Continued)

#### XC9131x05C (V<sub>OUT</sub>=1.8V)

L=2.2 μH (VLFCF4020), C<sub>L</sub>=20 μF (LMK212BJ106KG\*2)  
C<sub>IN</sub>=10 μF (LMK212BJ106KG), C<sub>DD</sub>=0.47 μF (EMK107BJ474KA)  
R<sub>FB1</sub>=390k Ω, R<sub>FB2</sub>=150k Ω, C<sub>FB</sub>=0pF, FO=OPEN

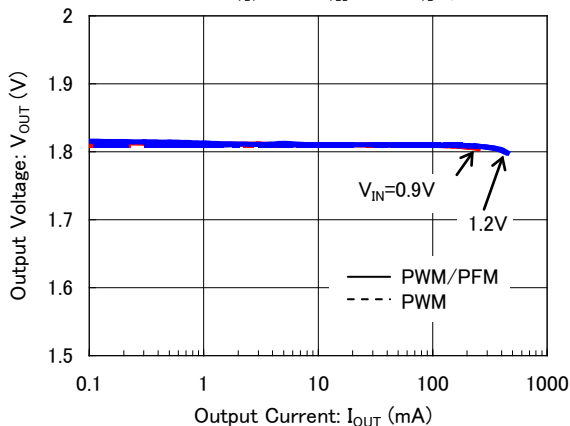

#### XC9131x05C (V<sub>OUT</sub>=5.0V)

L=4.7 μH (LTF5022-LC), C<sub>L</sub>=20 μF (LMK212BJ106KG\*2)  
C<sub>IN</sub>=10 μF (LMK212BJ106KG), C<sub>DD</sub>=0.47 μF (EMK107BJ474KA)  
R<sub>FB1</sub>=270k Ω, R<sub>FB2</sub>=30k Ω, C<sub>FB</sub>=10pF, FO=OPEN

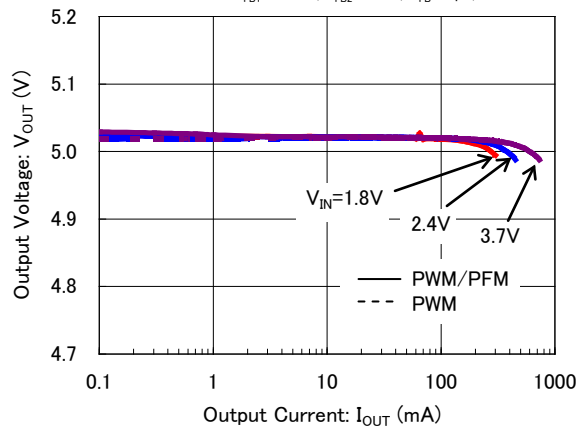

### (3) Ripple Voltage vs. Output Current

#### XC9131x05C (V<sub>OUT</sub>=3.3V)

L=2.2 μH (VLFCF4020), C<sub>L</sub>=20 μF (LMK212BJ106KG\*2)  
C<sub>IN</sub>=10 μF (LMK212BJ106KG), C<sub>DD</sub>=0.47 μF (EMK107BJ474KA)  
R<sub>FB1</sub>=560k Ω, R<sub>FB2</sub>=100k Ω, C<sub>FB</sub>=0pF, FO=OPEN

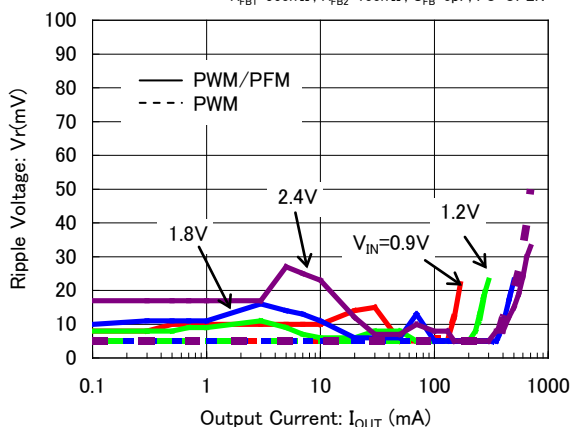

#### XC9131x05C (V<sub>OUT</sub>=3.3V)

L=4.7 μH (LTF5022-LC), C<sub>L</sub>=20 μF (LMK212BJ106KG\*2)  
C<sub>IN</sub>=10 μF (LMK212BJ106KG), C<sub>DD</sub>=0.47 μF (EMK107BJ474KA)  
R<sub>FB1</sub>=560k Ω, R<sub>FB2</sub>=100k Ω, C<sub>FB</sub>=10pF, FO=OPEN

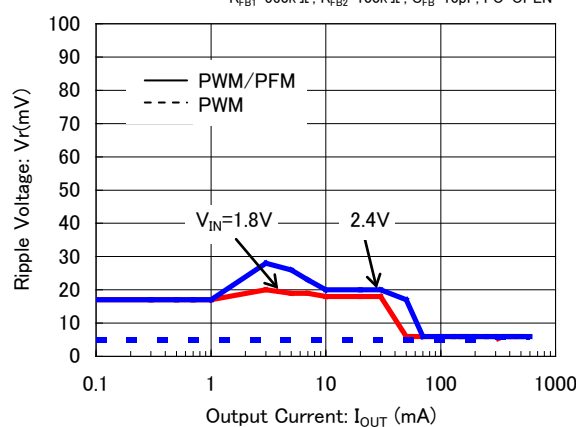

#### XC9131x05C (V<sub>OUT</sub>=1.8V)

L=2.2 μH (VLFCF4020), C<sub>L</sub>=20 μF (LMK212BJ106KG\*2)  
C<sub>IN</sub>=10 μF (LMK212BJ106KG), C<sub>DD</sub>=0.47 μF (EMK107BJ474KA)  
R<sub>FB1</sub>=390k Ω, R<sub>FB2</sub>=150k Ω, C<sub>FB</sub>=0pF, FO=OPEN

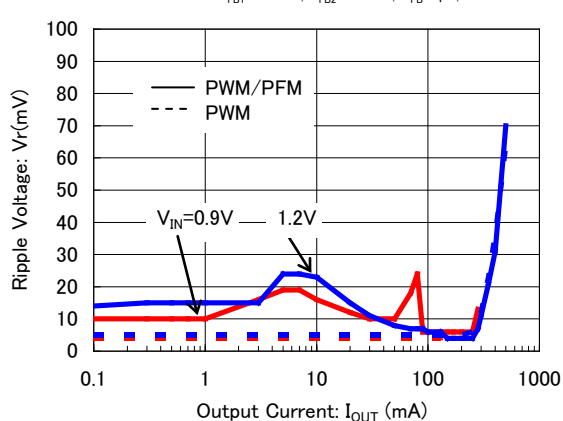

#### XC9131x05C (V<sub>OUT</sub>=5.0V)

L=4.7 μH (LTF5022-LC), C<sub>L</sub>=20 μF (LMK212BJ106KG\*2)  
C<sub>IN</sub>=10 μF (LMK212BJ106KG), C<sub>DD</sub>=0.47 μF (EMK107BJ474KA)  
R<sub>FB1</sub>=270k Ω, R<sub>FB2</sub>=30k Ω, C<sub>FB</sub>=10pF, FO=OPEN

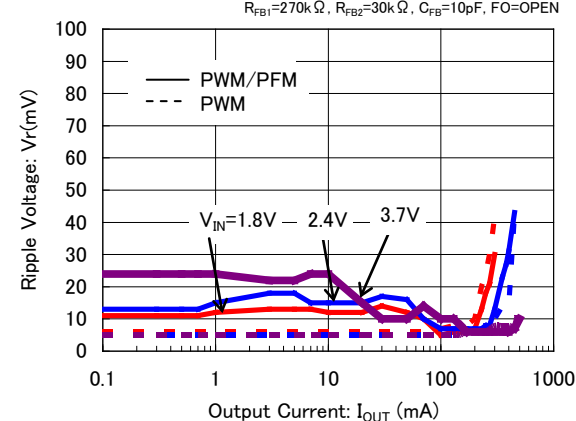

## TYPICAL PERFORMANCE CHARACTERISTICS (Continued)

(4) FB Voltage vs. Ambient Temperature

XC9131x05C

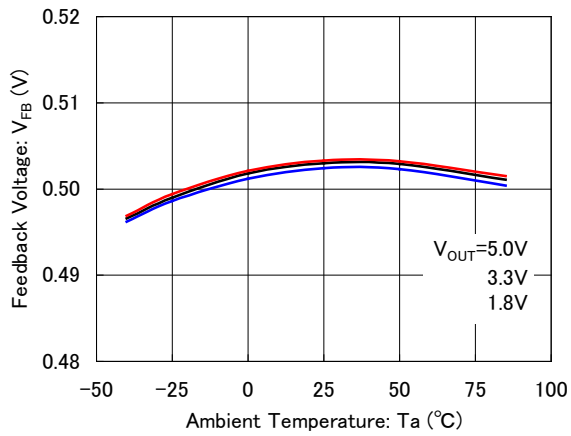

(5) Supply Current vs. Ambient Temperature

XC9131x05C

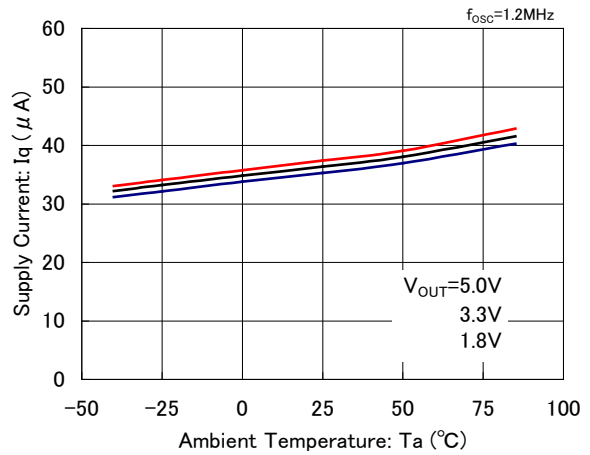

(6) Stand-by Current vs. Ambient Temperature

XC9131F05C

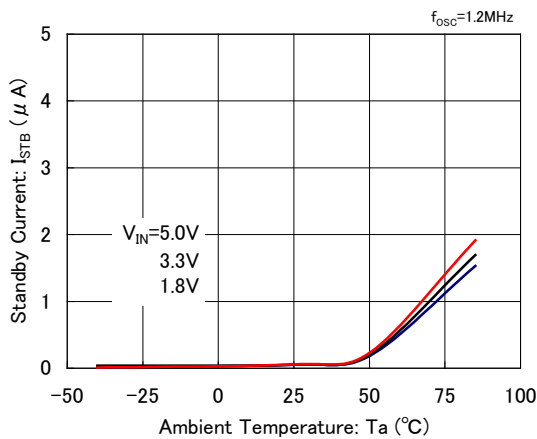

XC9131H05C

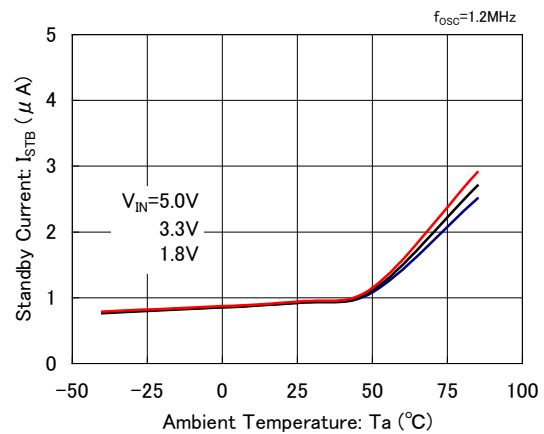

(7) Oscillation Frequency vs. Ambient Temperature

XC9131x05C

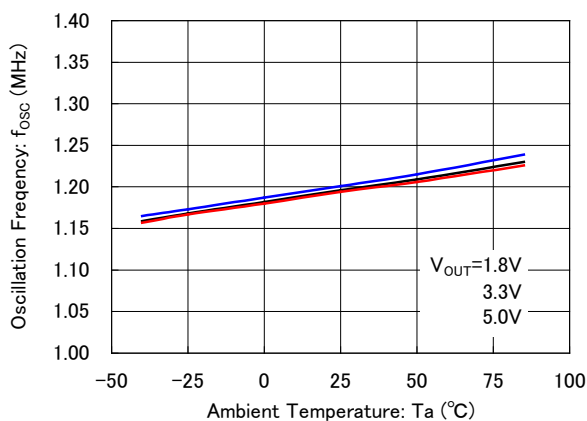

(8) Maximum Duty Cycle vs. Ambient Temperature

XC9131x05C

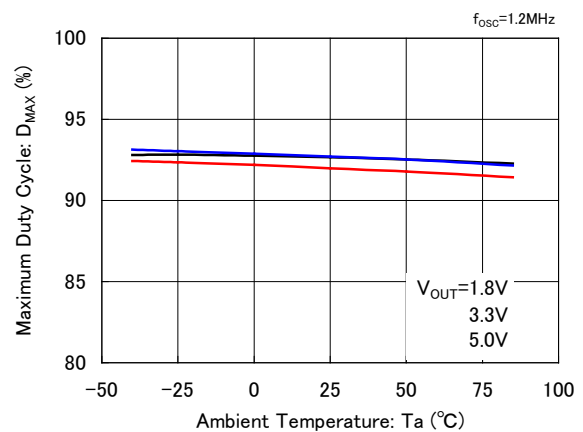

**TYPICAL PERFORMANCE CHARACTERISTICS (Continued)**

(9) Lx SW "N-ch" ON Resistance vs. Output Voltage

**XC9131x05C**

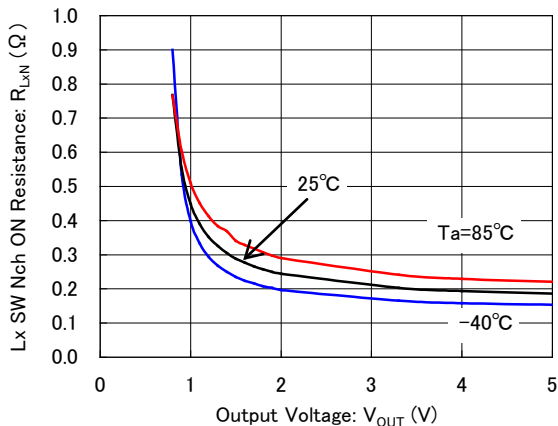

(10) Lx SW "P-ch" ON Resistance vs. Ambient Temperature

**XC9131x05C**

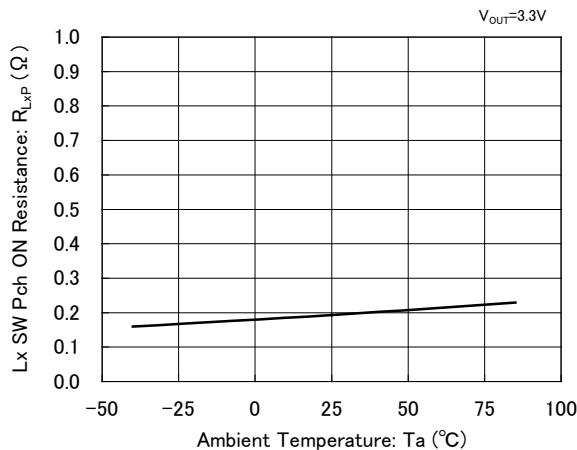

(11) Lx Leakage Current vs. Ambient Temperature

**XC9131x05C**

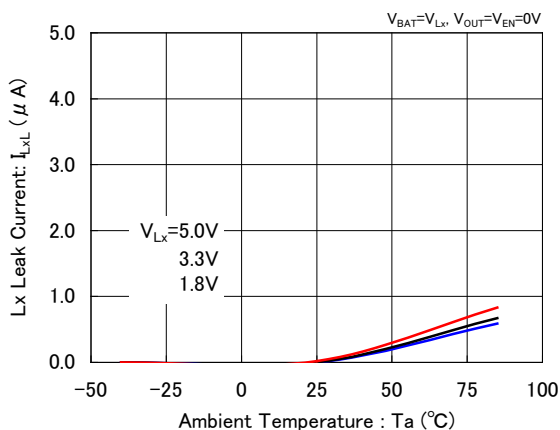

(12) Soft-Start Time vs. Ambient Temperature

**XC9131x05C**

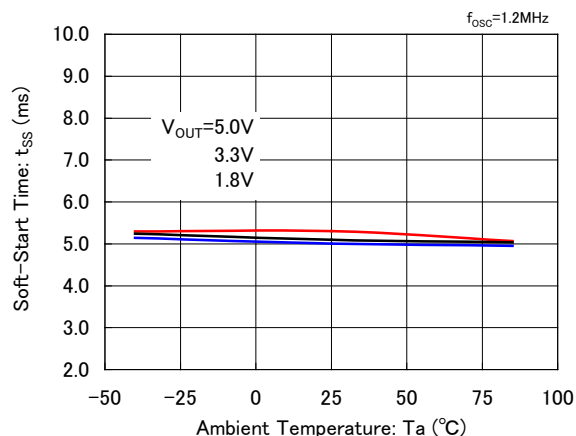

(13) PFM Switch Current vs. Input Voltage

**XC9131x05C**

$V_{OUT}=5V, f_{osc}=1.2MHz$   
 $L=4.7\mu H$  (LTF5022-LC),  $C_L=22\mu F$  (ceramic)  
 $C_{IN}=10\mu F$  (ceramic),  $C_{DD}=0.47\mu F$  (ceramic)

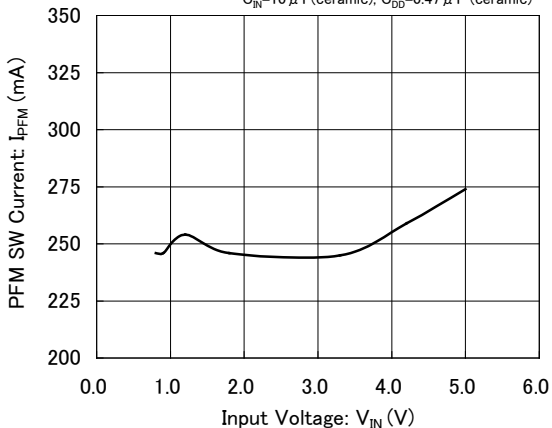

(14) MODE "H", "L" Voltage vs. Output Voltage

**XC9131x05C**

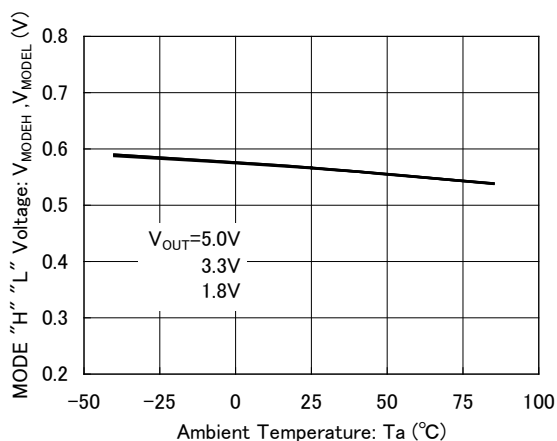

## TYPICAL PERFORMANCE CHARACTERISTICS (Continued)

(15) EN "H" Voltage vs. Output Voltage

XC9131x05C

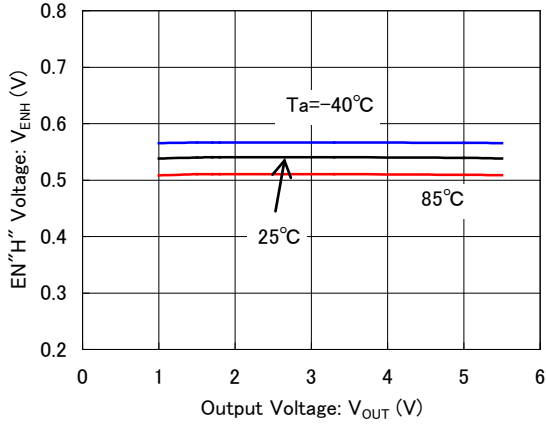

(16) EN "L" Voltage vs. Output Voltage

XC9131x05C

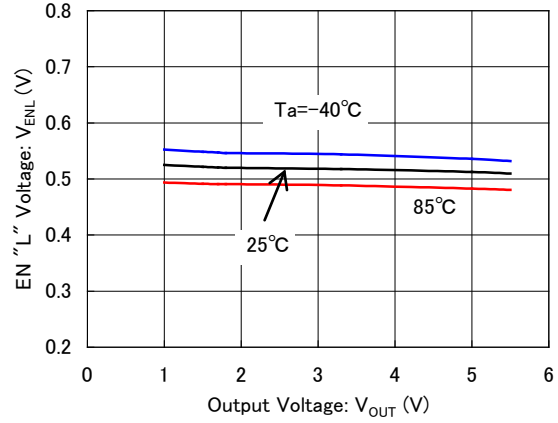

(17) Operation Start Voltage vs. Ambient Temperature

XC9131x05C

MODE:PWM/PFM,  $R_L=1k\Omega$ ,  $f_{osc}=1.2MHz$   
 $L=2.2\mu H$  (VLFCF4020),  $C_L=22\mu F$  (ceramic)  
 $C_{IN}=10\mu F$  (ceramic),  $C_{DD}=0.47\mu F$  (ceramic)

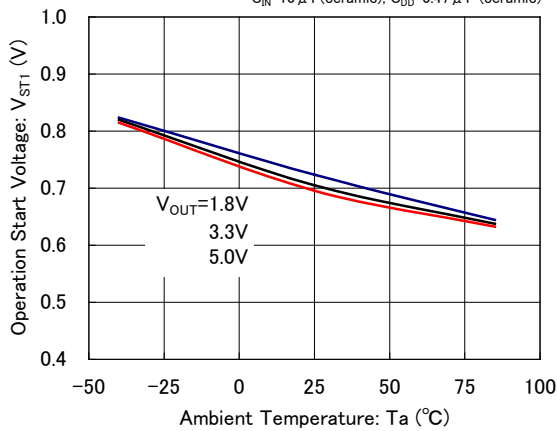

XC9131x05C

MODE:PWM/PFM,  $R_L=33\Omega$ ,  $f_{osc}=1.2MHz$   
 $L=2.2\mu H$  (VLFCF4020),  $C_L=22\mu F$  (ceramic)  
 $C_{IN}=10\mu F$  (ceramic),  $C_{DD}=0.47\mu F$  (ceramic)

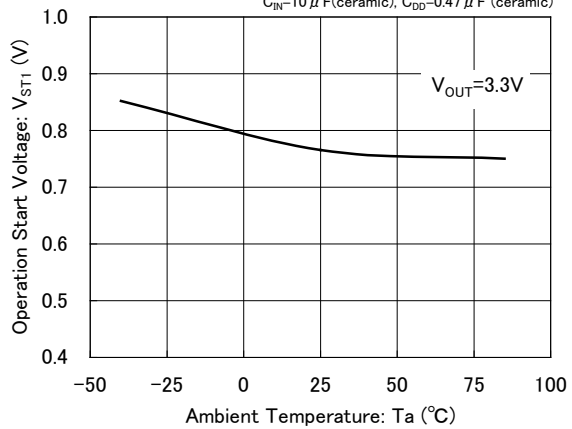

(18) Operation Hold Voltage vs. Ambient Temperature

XC9131x05C

MODE:PWM/PFM,  $R_L=1k\Omega$ ,  $f_{osc}=1.2MHz$   
 $L=2.2\mu H$  (VLFCF4020),  $C_L=22\mu F$  (ceramic)  
 $C_{IN}=10\mu F$  (ceramic),  $C_{DD}=0.47\mu F$  (ceramic)

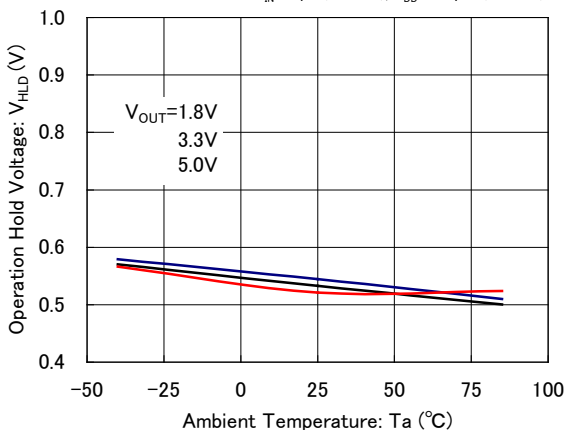

(19) No Load Input Current vs. Input Voltage

XC9131x05C

MODE:PWM/PFM,  $R_L=OPEN$ ,  $f_{osc}=1.2MHz$   
 $L=2.2\mu H$  (VLFCF4020),  $C_L=22\mu F$  (ceramic)  
 $C_{IN}=10\mu F$  (ceramic),  $C_{DD}=0.47\mu F$  (ceramic),  $T_a=25^\circ C$

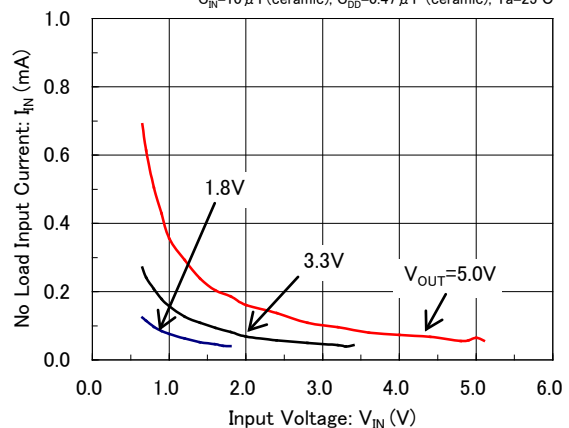

## ■ TYPICAL PERFORMANCE CHARACTERISTICS (Continued)

(20) FO ON Resistance vs. Ambient Temperature

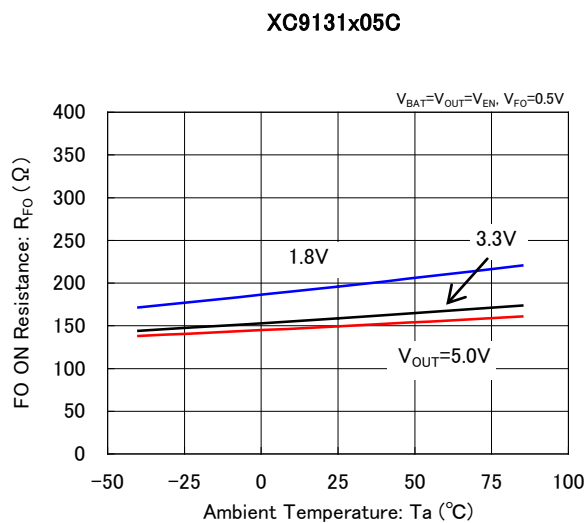

(21) CL Discharge Resistance vs. Ambient Temperature

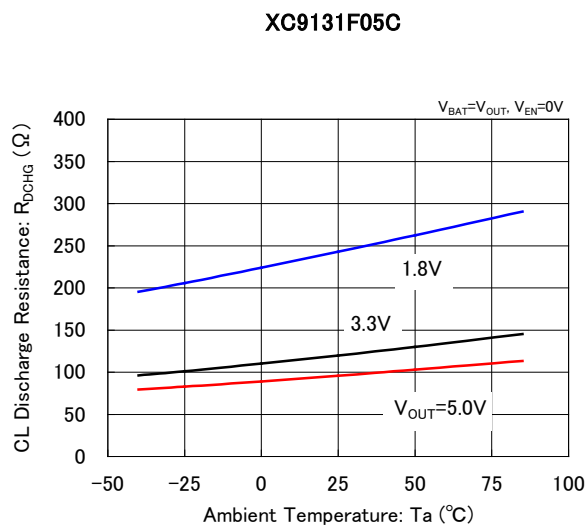

## TYPICAL PERFORMANCE CHARACTERISTICS (Continued)

(22) Soft-start

$V_{OUT}=3.3V$ ,  $V_{IN}=1.8V$ ,  $R_L=33\Omega$ , MODE:PWM/PFM

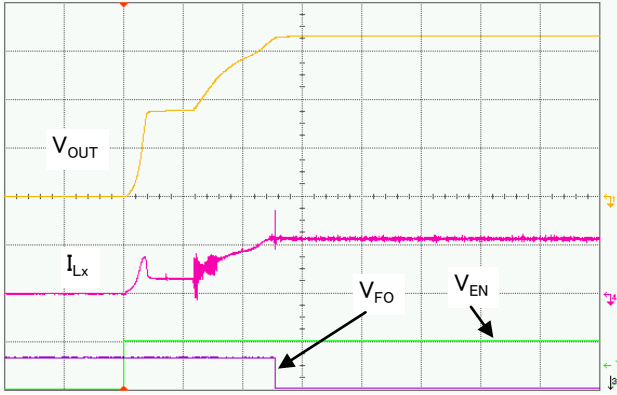

XC9131x05C (1.2MHz)  
 $V_{OUT}:1V/div$ ,  $I_{Lx}:200mA/div$ ,  $V_{EN}:5V/div$ ,  $V_{FO}:5V/div$  Time:2ms/div  
 $L=4.7\mu H$ (LTF5022-LC),  $C_L=20\mu F$ (LMK212BJ106KG\*2)  
 $C_{IN}=10\mu F$ (LMK212BJ106KG),  $C_{OD}=0.47\mu F$ (EMK107BJ474KA)  
 $R_{FB1}=560k\Omega$ ,  $R_{FB2}=100k\Omega$ ,  $C_{FB}=10pF$

$V_{OUT}=5.0V$ ,  $V_{IN}=5.5V$ ,  $R_L=50\Omega$

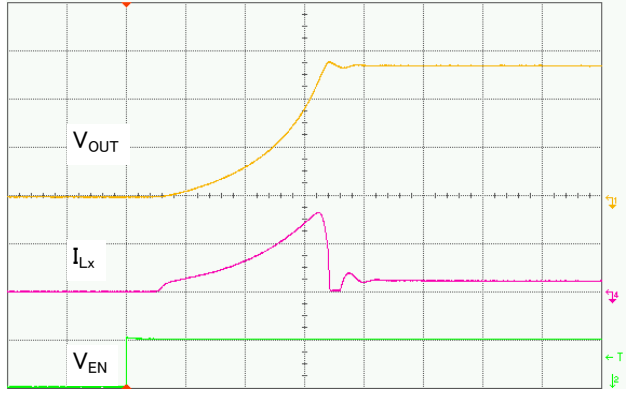

XC9131x05C (1.2MHz)  
 $V_{OUT}:2V/div$ ,  $I_{Lx}:500mA/div$ ,  $V_{EN}:5V/div$ , Time:100us/div  
 $L=4.7\mu H$ (LTF5022-LC),  $C_L=20\mu F$ (LMK212BJ106KG\*2)  
 $C_{IN}=10\mu F$ (LMK212BJ106KG),  $C_{OD}=0.47\mu F$ (EMK107BJ474KA)  
 $R_{FB1}=270k\Omega$ ,  $R_{FB2}=30k\Omega$ ,  $C_{FB}=10pF$

$V_{OUT}=2.0V$ ,  $V_{IN}=0.9V$ ,  $R_L=20\Omega$ , MODE:PWM/PFM

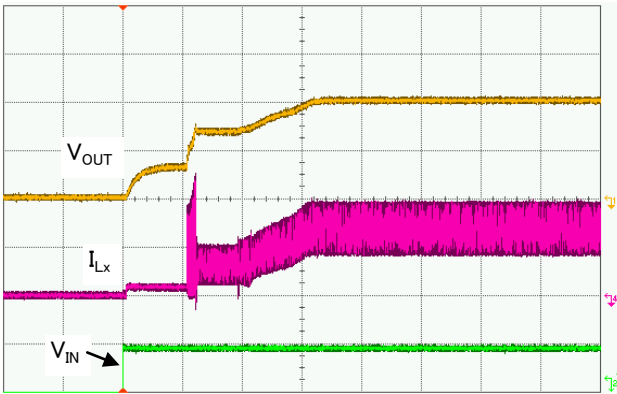

XC9131x05C(1.2MHz)  
 $V_{OUT}:1V/div$ ,  $I_{Lx}:200mA/div$ ,  $V_{IN}:1V/div$ , Time:2ms/div  
 $L=2.2\mu H$ (VLS252012),  $C_L=22\mu F$ (LMK212BJ226MG)  
 $C_{IN}=10\mu F$ (LMK212BJ106KG),  $C_{OD}=0.47\mu F$ (EMK107BJ474KA)  
 $R_{FB1}=300k\Omega$ ,  $R_{FB2}=100k\Omega$ ,  $C_{FB}=0pF$

## TYPICAL PERFORMANCE CHARACTERISTICS (Continued)

### (23) Load Transient Response

$V_{OUT}=1.8V, V_{IN}=0.9V, I_{OUT}=1mA \rightarrow 100mA$

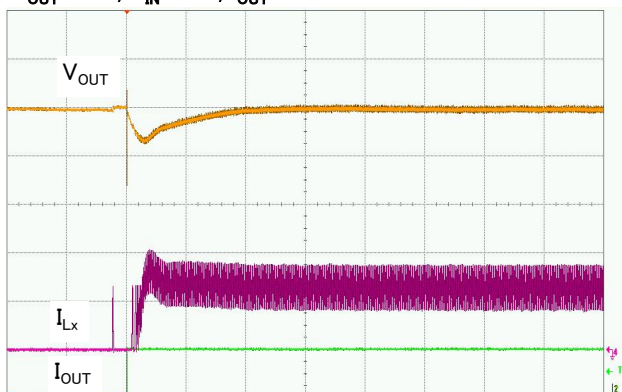

XC9131x05C (1.2MHz, PWM/PFM)

$V_{OUT}:100mV/div, I_{LX}:200mA/div, I_{OUT}:100mA/div, Time:50\mu s/div$

$L=2.2\mu H(LTF5022-LC), C_L=20\mu F(LMK212BJ106KG*2)$

$C_{IN}=10\mu F(LMK212BJ106KG), C_{DD}=0.47\mu F(EMK107BJ474KA)$

$R_{FB1}=390k\Omega, R_{FB2}=150k\Omega, C_{FB}=0pF$

$V_{OUT}=1.8V, V_{IN}=0.9V, I_{OUT}=100mA \rightarrow 1mA$

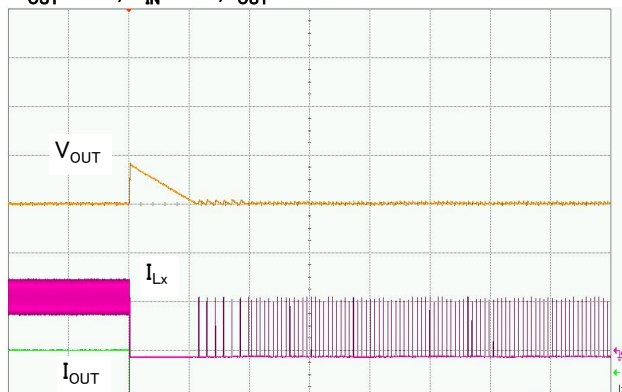

XC9131x05C (1.2MHz, PWM/PFM)

$V_{OUT}:100mV/div, I_{LX}:200mA/div, I_{OUT}:100mA/div, Time:1ms/div$

$L=2.2\mu H(LTF5022-LC), C_L=20\mu F(LMK212BJ106KG*2)$

$C_{IN}=10\mu F(LMK212BJ106KG), C_{DD}=0.47\mu F(EMK107BJ474KA)$

$R_{FB1}=390k\Omega, R_{FB2}=150k\Omega, C_{FB}=0pF$

$V_{OUT}=3.3V, V_{IN}=1.8V, I_{OUT}=1mA \rightarrow 200mA$

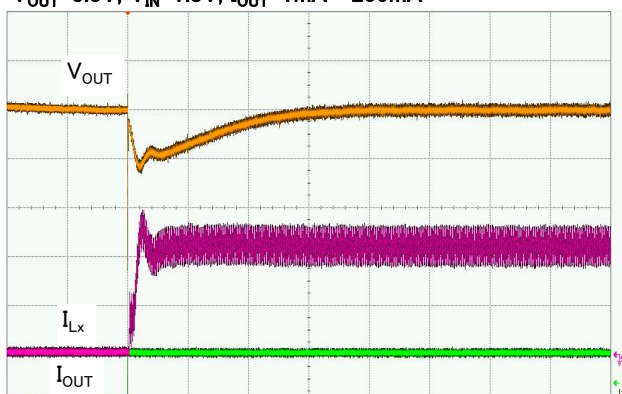

XC9131x05C (1.2MHz, PWM/PFM)

$V_{OUT}:100mV/div, I_{LX}:200mA/div, I_{OUT}:200mA/div, Time:50\mu s/div$

$L=4.7\mu H(LTF5022-LC), C_L=20\mu F(LMK212BJ106KG*2)$

$C_{IN}=10\mu F(LMK212BJ106KG), C_{DD}=0.47\mu F(EMK107BJ474KA)$

$R_{FB1}=560k\Omega, R_{FB2}=100k\Omega, C_{FB}=10pF$

$V_{OUT}=3.3V, V_{IN}=1.8V, I_{OUT}=200mA \rightarrow 1mA$

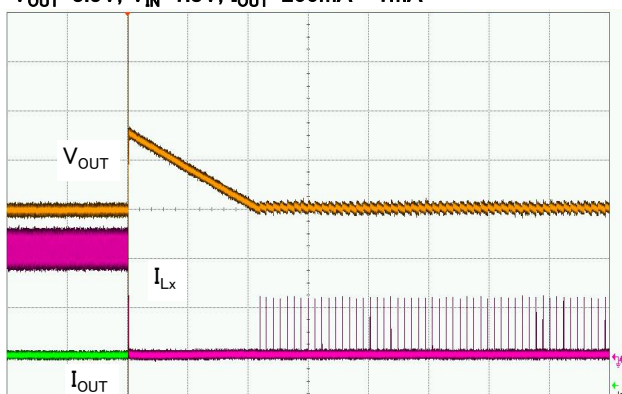

XC9131x05C (1.2MHz, PWM/PFM)

$V_{OUT}:100mV/div, I_{LX}:200mA/div, I_{OUT}:200mA/div, Time:1ms/div$

$L=4.7\mu H(LTF5022-LC), C_L=20\mu F(LMK212BJ106KG*2)$

$C_{IN}=10\mu F(LMK212BJ106KG), C_{DD}=0.47\mu F(EMK107BJ474KA)$

$R_{FB1}=560k\Omega, R_{FB2}=100k\Omega, C_{FB}=10pF$

$V_{OUT}=3.3V, V_{IN}=1.8V, I_{OUT}=1mA \rightarrow 200mA$

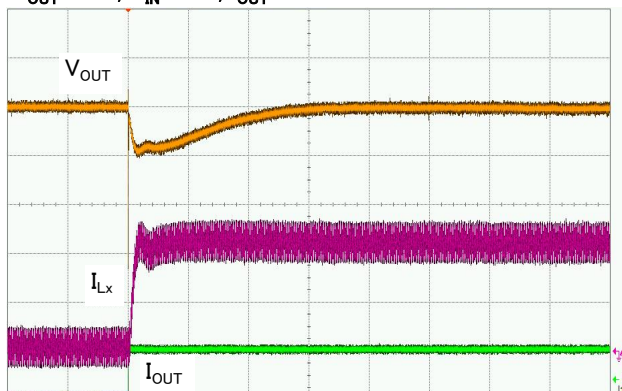

XC9131x05C (1.2MHz, PWM)

$V_{OUT}:100mV/div, I_{LX}:200mA/div, I_{OUT}:200mA/div, Time:50\mu s/div$

$L=4.7\mu H(LTF5022-LC), C_L=20\mu F(LMK212BJ106KG*2)$

$C_{IN}=10\mu F(LMK212BJ106KG), C_{DD}=0.47\mu F(EMK107BJ474KA)$

$R_{FB1}=560k\Omega, R_{FB2}=100k\Omega, C_{FB}=10pF$

$V_{OUT}=3.3V, V_{IN}=1.8V, I_{OUT}=200mA \rightarrow 1mA$

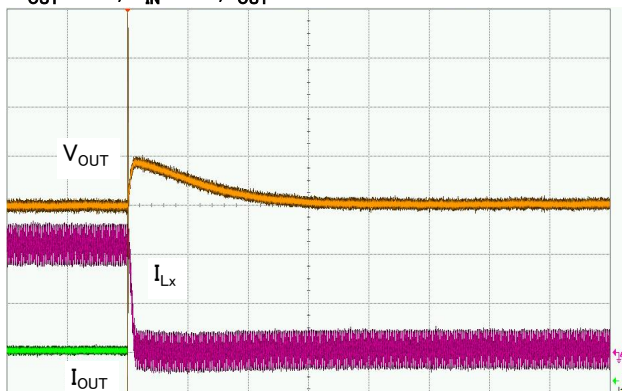

XC9131x05C (1.2MHz, PWM)

$V_{OUT}:100mV/div, I_{LX}:200mA/div, I_{OUT}:200mA/div, Time:50\mu s/div$

$L=4.7\mu H(LTF5022-LC), C_L=20\mu F(LMK212BJ106KG*2)$

$C_{IN}=10\mu F(LMK212BJ106KG), C_{DD}=0.47\mu F(EMK107BJ474KA)$

$R_{FB1}=560k\Omega, R_{FB2}=100k\Omega, C_{FB}=10pF$

## TYPICAL PERFORMANCE CHARACTERISTICS (Continued)

### (24) Load Transient Response (Continued)

$V_{OUT}=5.0V$ ,  $V_{IN}=3.7V$ ,  $I_{OUT}=1mA \rightarrow 300mA$

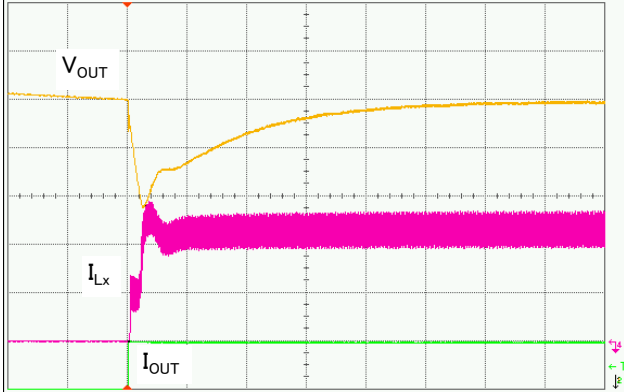

XC9131x05C(1.2MHz,PWM/PFM)

$V_{OUT}:100mV/div$ ,  $I_{Lx}:200mA/div$ ,  $I_{OUT}:300mA/div$ , Time:50  $\mu s/div$

$L=4.7 \mu H$ (LTF5022-LC),  $C_L=20 \mu F$ (LMK212BJ106KG\*2)

$C_{IN}=10 \mu F$ (LMK212BJ106KG),  $C_{OD}=0.47 \mu F$ (EMK107BJ474KA)

$R_{FB1}=270k \Omega$ ,  $R_{FB2}=30k \Omega$ ,  $C_{FB}=10pF$

$V_{OUT}=5.0V$ ,  $V_{IN}=3.7V$ ,  $I_{OUT}=300mA \rightarrow 1mA$

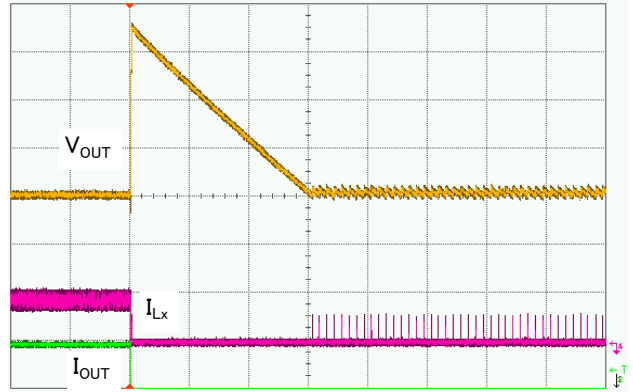

XC9131x05C(1.2MHz,PWM/PFM)

$V_{OUT}:100mV/div$ ,  $I_{Lx}:500mA/div$ ,  $I_{OUT}:300mA/div$ , Time:1ms/div

$L=4.7 \mu H$ (LTF5022-LC),  $C_L=20 \mu F$ (LMK212BJ106KG\*2)

$C_{IN}=10 \mu F$ (LMK212BJ106KG),  $C_{OD}=0.47 \mu F$ (EMK107BJ474KA)

$R_{FB1}=270k \Omega$ ,  $R_{FB2}=30k \Omega$ ,  $C_{FB}=10pF$

$V_{OUT}=5.0V$ ,  $V_{IN}=3.7V$ ,  $I_{OUT}=100mA \rightarrow 500mA$

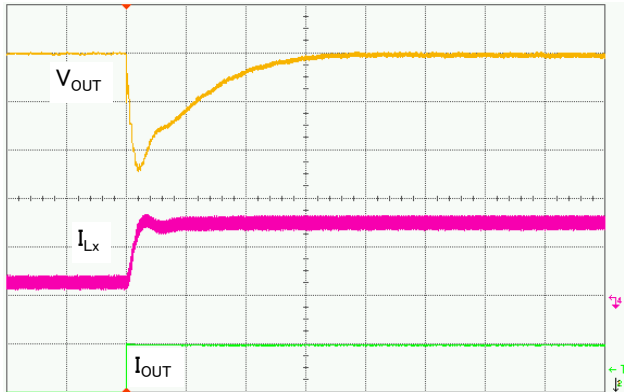

XC9131x05C(1.2MHz,PWM)

$V_{OUT}:100mV/div$ ,  $I_{Lx}:500mA/div$ ,  $I_{OUT}:400mA/div$ , Time:50  $\mu s/div$

$L=4.7 \mu H$ (LTF5022-LC),  $C_L=20 \mu F$ (LMK212BJ106KG\*2)

$C_{IN}=10 \mu F$ (LMK212BJ106KG),  $C_{OD}=0.47 \mu F$ (EMK107BJ474KA)

$R_{FB1}=270k \Omega$ ,  $R_{FB2}=30k \Omega$ ,  $C_{FB}=10pF$

$V_{OUT}=5.0V$ ,  $V_{IN}=3.7V$ ,  $I_{OUT}=500mA \rightarrow 100mA$

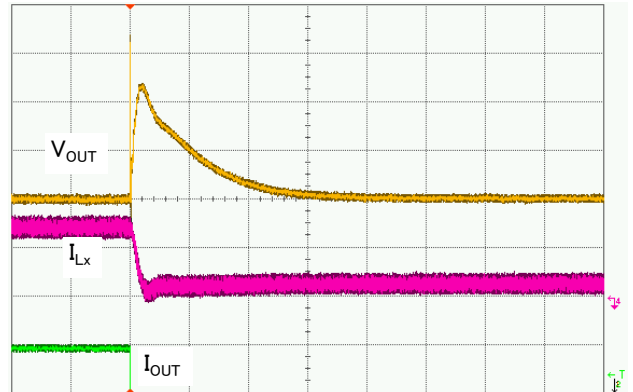

XC9131x05C(1.2MHz,PWM)

$V_{OUT}:100mV/div$ ,  $I_{Lx}:500mA/div$ ,  $I_{OUT}:400mA/div$ , Time:50  $\mu s/div$

$L=4.7 \mu H$ (LTF5022-LC),  $C_L=20 \mu F$ (LMK212BJ106KG\*2)

$C_{IN}=10 \mu F$ (LMK212BJ106KG),  $C_{OD}=0.47 \mu F$ (EMK107BJ474KA)

$R_{FB1}=270k \Omega$ ,  $R_{FB2}=30k \Omega$ ,  $C_{FB}=10pF$



**PACKAGING INFORMATION**

● USP-10B

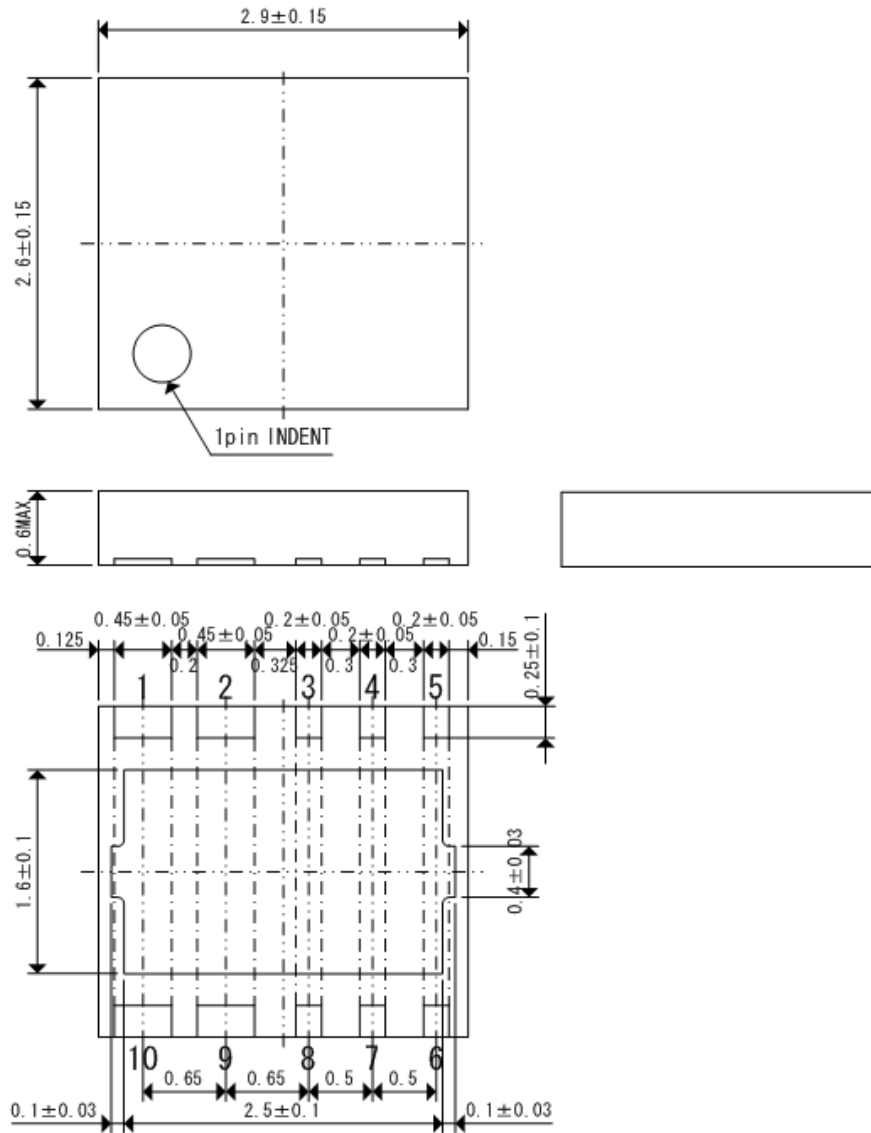

## PACKAGING INFORMATION (Continued)

● USP-10B Reference Pattern Layout

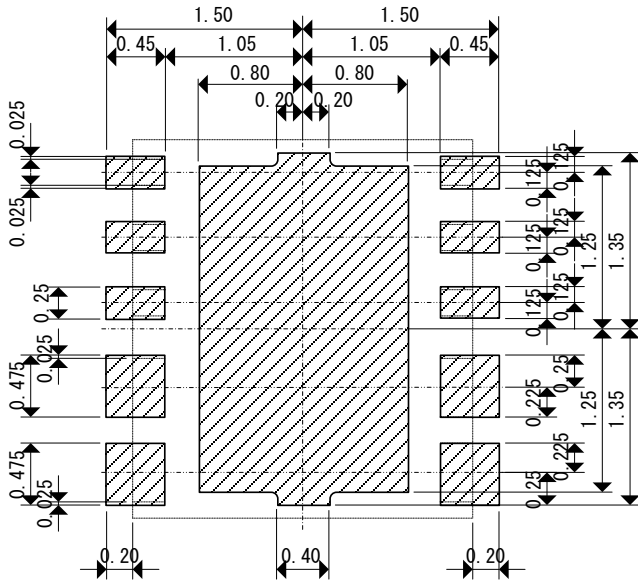

● USP-10B Reference Metal Mask Design

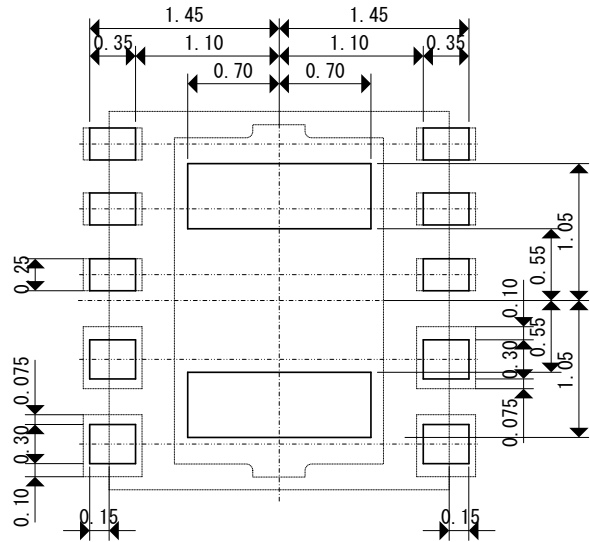

## MARKING RULE

### ● USP-10B

① represents product series

MARK	PRODUCT SERIES
3	XC9131*****-G

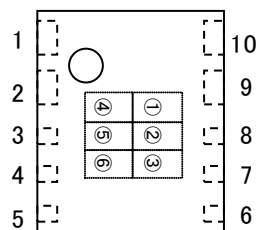

USP-10B  
(TOP VIEW)

② represents a type of DC/DC converters

MARK	ITEM	DESCRIPTION	PRODUCT SERIES
F	Output voltage externally set-up(FB)	With C <sub>L</sub> Auto Discharge	XC9131F*****-G
H	Output voltage externally set-up(FB)	Without C <sub>L</sub> Auto Discharge	XC9131H*****-G

③④ represents reference voltage and oscillation frequency

MARK		VOLTAGE(V)	OSCILLATION FREQUENCY(kHz)	PRODUCT SERIES
③	④			
5	C	0.5	1200	XC9131*05C**-G

⑤⑥ represents production lot number

01~09, 0A~0Z, 11~9Z, A1~A9, AA~Z9, ZA~ZZ in order.

(G, I, J, O, Q, W excluded)

\*No character inversion used.

1. The products and product specifications contained herein are subject to change without notice to improve performance characteristics. Consult us, or our representatives before use, to confirm that the information in this datasheet is up to date.
2. We assume no responsibility for any infringement of patents, patent rights, or other rights arising from the use of any information and circuitry in this datasheet.
3. Please ensure suitable shipping controls (including fail-safe designs and aging protection) are in force for equipment employing products listed in this datasheet.
4. The products in this datasheet are not developed, designed, or approved for use with such equipment whose failure of malfunction can be reasonably expected to directly endanger the life of, or cause significant injury to, the user.  
(e.g. Atomic energy; aerospace; transport; combustion and associated safety equipment thereof.)
5. Please use the products listed in this datasheet within the specified ranges.  
Should you wish to use the products under conditions exceeding the specifications, please consult us or our representatives.
6. We assume no responsibility for damage or loss due to abnormal use.
7. All rights reserved. No part of this datasheet may be copied or reproduced without the prior permission of TOREX SEMICONDUCTOR LTD.

**TOREX SEMICONDUCTOR LTD.**

# Mouser Electronics

Authorized Distributor

Click to View Pricing, Inventory, Delivery & Lifecycle Information:

[Torex Semiconductor:](#)

[XC9131F05CDR-G](#) [XC9131H05CDR-G](#)