

# 3 Watt Plastic Surface Mount Zener Voltage Regulators

## 1SMB59xxBT3G Series, SZ1SMB59xxT3G Series

This complete new line of 3 W Zener diodes offers the following advantages.

### Features

- Zener Voltage Range – 3.3 V to 200 V
- ESD Rating of Class 3 (> 16 kV) per Human Body Model
- Flat Handling Surface for Accurate Placement
- Package Design for Top Side or Bottom Circuit Board Mounting
- AEC-Q101 Qualified and PPAP Capable – SZ1SMB59xxT3G
- SZ Prefix for Automotive and Other Applications Requiring Unique Site and Control Change Requirements
- These are Pb-Free Devices\*

### Mechanical Characteristics:

**CASE:** Void-free, transfer-molded plastic

**FINISH:** All external surfaces are corrosion resistant and leads are readily solderable

**MAXIMUM LEAD TEMPERATURE FOR SOLDERING PURPOSES:** 260°C for 10 Seconds

**LEADS:** Modified L-Bend providing more contact area to bond pads

**POLARITY:** Cathode indicated by polarity band

**FLAMMABILITY RATING:** UL 94 V-0

### MAXIMUM RATINGS

Rating	Symbol	Value	Unit
Maximum Steady State Power Dissipation @ $T_L = 75^\circ\text{C}$ Measured at Zero Lead Length Derate Above $75^\circ\text{C}$	$P_D$	3.0	W
Thermal Resistance from Junction-to-Lead	$R_{\theta JL}$	40 25	$\text{mW}/^\circ\text{C}$ $^\circ\text{C}/\text{W}$
Maximum Steady State Power Dissipation @ $T_A = 25^\circ\text{C}$ (Note) Derate Above $25^\circ\text{C}$	$P_D$	550	mW
Thermal Resistance from Junction-to-Ambient	$R_{\theta JA}$	4.4 226	$\text{mW}/^\circ\text{C}$ $^\circ\text{C}/\text{W}$
Operating and Storage Temperature Range	$T_J, T_{stg}$	-65 to +150	$^\circ\text{C}$

Stresses exceeding those listed in the Maximum Ratings table may damage the device. If any of these limits are exceeded, device functionality should not be assumed, damage may occur and reliability may be affected.

1. FR-4 board, using recommended footprint.

\*For additional information on our Pb-Free strategy and soldering details, please download the onsemi Soldering and Mounting Techniques Reference Manual, SOLDERRM/D.

## PLASTIC SURFACE MOUNT ZENER VOLTAGE REGULATOR DIODES 3.3–200 V, 3 W DC POWER



SMB  
CASE 403A  
PLASTIC

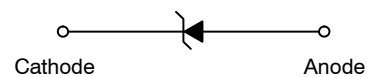

### MARKING DIAGRAM



- A = Assembly Location
- Y = Year
- WW = Work Week
- 9xxB = Device Code (Refer to page 3)
- = Pb-Free Package

(Note: Microdot may be in either location)

### ORDERING INFORMATION

Device	Package	Shipping <sup>†</sup>
1SMB59xxBT3G	SMB (Pb-Free)	2,500 / Tape & Reel
SZ1SMB59xxBT3G	SMB (Pb-Free)	2,500 / Tape & Reel

<sup>†</sup>For information on tape and reel specifications, including part orientation and tape sizes, please refer to our Tape and Reel Packaging Specifications Brochure, BRD8011/D.

### DEVICE MARKING INFORMATION

See specific marking information in the device marking column of the Electrical Characteristics table on page 3 of this data sheet.

# 1SMB59xxBT3G Series, SZ1SMB59xxT3G Series

## ELECTRICAL CHARACTERISTICS

( $T_L = 30^\circ\text{C}$  unless otherwise noted,

$V_F = 1.5\text{ V Max. @ } I_F = 200\text{ mA(dc)}$  for all types)

Symbol	Parameter
$V_Z$	Reverse Zener Voltage @ $I_{ZT}$
$I_{ZT}$	Reverse Current
$Z_{ZT}$	Maximum Zener Impedance @ $I_{ZT}$
$I_{ZK}$	Reverse Current
$Z_{ZK}$	Maximum Zener Impedance @ $I_{ZK}$
$I_R$	Reverse Leakage Current @ $V_R$
$V_R$	Reverse Voltage
$I_F$	Forward Current
$V_F$	Forward Voltage @ $I_F$
$I_{ZM}$	Maximum DC Zener Current



# 1SMB59xxBT3G Series, SZ1SMB59xxT3G Series

**ELECTRICAL CHARACTERISTICS** ( $T_L = 30^\circ\text{C}$  unless otherwise noted,  $V_F = 1.5\text{ V Max.}$  @  $I_F = 200\text{ mA(dc)}$  for all types)  
(Devices listed in **bold, italic** are onsemi Preferred devices.)

Device* (Note 2)	Device Marking	Zener Voltage (Note 3)				Zener Impedance (Note 4)			Leakage Current		$I_{ZM}$ mA(dc)
		$V_Z$ (Volts)			@ $I_{ZT}$	$Z_{ZT}$ @ $I_{ZT}$	$Z_{ZK}$ @ $I_{ZK}$		$I_R$ @ $V_R$		
		Min	Nom	Max	mA	$\Omega$	$\Omega$	mA	$\mu\text{A}$	Volts	
1SMB5913BT3G	913B	3.13	3.3	3.47	113.6	10	500	1	100	1	454
1SMB5914BT3G	914B	3.42	3.6	3.78	104.2	9	500	1	75	1	416
<b>1SMB5915BT3G</b>	<b>915B</b>	<b>3.70</b>	<b>3.9</b>	<b>4.10</b>	<b>96.1</b>	<b>7.5</b>	<b>500</b>	<b>1</b>	<b>25</b>	<b>1</b>	<b>384</b>
<b>1SMB5916BT3G</b>	<b>916B</b>	<b>4.08</b>	<b>4.3</b>	<b>4.52</b>	<b>87.2</b>	<b>6</b>	<b>500</b>	<b>1</b>	<b>5</b>	<b>1</b>	<b>348</b>
<b>1SMB5917BT3G</b>	<b>917B</b>	<b>4.46</b>	<b>4.7</b>	<b>4.94</b>	<b>79.8</b>	<b>5</b>	<b>500</b>	<b>1</b>	<b>5</b>	<b>1.5</b>	<b>319</b>
<b>1SMB5918BT3G</b>	<b>918B</b>	<b>4.84</b>	<b>5.1</b>	<b>5.36</b>	<b>73.5</b>	<b>4</b>	<b>350</b>	<b>1</b>	<b>5</b>	<b>2</b>	<b>294</b>
<b>1SMB5919BT3G</b>	<b>919B</b>	<b>5.32</b>	<b>5.6</b>	<b>5.88</b>	<b>66.9</b>	<b>2</b>	<b>250</b>	<b>1</b>	<b>5</b>	<b>3</b>	<b>267</b>
<b>1SMB5920BT3G</b>	<b>920B</b>	<b>5.89</b>	<b>6.2</b>	<b>6.51</b>	<b>60.5</b>	<b>2</b>	<b>200</b>	<b>1</b>	<b>5</b>	<b>4</b>	<b>241</b>
1SMB5921BT3G	921B	6.46	6.8	7.14	55.1	2.5	200	1	5	5.2	220
1SMB5922BT3G	922B	7.12	7.5	7.88	50	3	400	0.5	5	6	200
<b>1SMB5923BT3G</b>	<b>923B</b>	<b>7.79</b>	<b>8.2</b>	<b>8.61</b>	<b>45.7</b>	<b>3.5</b>	<b>400</b>	<b>0.5</b>	<b>5</b>	<b>6.5</b>	<b>182</b>
1SMB5924BT3G	924B	8.64	9.1	9.56	41.2	4	500	0.5	5	7	164
<b>1SMB5925BT3G</b>	<b>925B</b>	<b>9.5</b>	<b>10</b>	<b>10.5</b>	<b>37.5</b>	<b>4.5</b>	<b>500</b>	<b>0.25</b>	<b>5</b>	<b>8</b>	<b>150</b>
<b>1SMB5926BT3G</b>	<b>926B</b>	<b>10.45</b>	<b>11</b>	<b>11.55</b>	<b>34.1</b>	<b>5.5</b>	<b>550</b>	<b>0.25</b>	<b>1</b>	<b>8.4</b>	<b>136</b>
<b>1SMB5927BT3G</b>	<b>927B</b>	<b>11.4</b>	<b>12</b>	<b>12.6</b>	<b>31.2</b>	<b>6.5</b>	<b>550</b>	<b>0.25</b>	<b>1</b>	<b>9.1</b>	<b>125</b>
1SMB5928BT3G	928B	12.35	13	13.65	28.8	7	550	0.25	1	9.9	115
<b>1SMB5929BT3G</b>	<b>929B</b>	<b>14.25</b>	<b>15</b>	<b>15.75</b>	<b>25</b>	<b>9</b>	<b>600</b>	<b>0.25</b>	<b>1</b>	<b>11.4</b>	<b>100</b>
1SMB5930BT3G	930B	15.2	16	16.8	23.4	10	600	0.25	1	12.2	93
<b>1SMB5931BT3G</b>	<b>931B</b>	<b>17.1</b>	<b>18</b>	<b>18.9</b>	<b>20.8</b>	<b>12</b>	<b>650</b>	<b>0.25</b>	<b>1</b>	<b>13.7</b>	<b>83</b>
1SMB5932BT3G	932B	19	20	21	18.7	14	650	0.25	1	15.2	75
1SMB5933BT3G	933B	20.9	22	23.1	17	17.5	650	0.25	1	16.7	68
<b>1SMB5934BT3G</b>	<b>934B</b>	<b>22.8</b>	<b>24</b>	<b>25.2</b>	<b>15.6</b>	<b>19</b>	<b>700</b>	<b>0.25</b>	<b>1</b>	<b>18.2</b>	<b>62</b>
<b>1SMB5935BT3G</b>	<b>935B</b>	<b>25.65</b>	<b>27</b>	<b>28.35</b>	<b>13.9</b>	<b>23</b>	<b>700</b>	<b>0.25</b>	<b>1</b>	<b>20.6</b>	<b>55</b>
<b>1SMB5936BT3G</b>	<b>936B</b>	<b>28.5</b>	<b>30</b>	<b>31.5</b>	<b>12.5</b>	<b>28</b>	<b>750</b>	<b>0.25</b>	<b>1</b>	<b>22.8</b>	<b>50</b>
1SMB5937BT3G	937B	31.35	33	34.65	11.4	33	800	0.25	1	25.1	45
<b>1SMB5938BT3G</b>	<b>938B</b>	<b>34.2</b>	<b>36</b>	<b>37.8</b>	<b>10.4</b>	<b>38</b>	<b>850</b>	<b>0.25</b>	<b>1</b>	<b>27.4</b>	<b>41</b>
1SMB5939BT3G	939B	37.05	39	40.95	9.6	45	900	0.25	1	29.7	38
1SMB5940BT3G	940B	40.85	43	45.15	8.7	53	950	0.25	1	32.7	34
1SMB5941BT3G	941B	44.65	47	49.35	8	67	1000	0.25	1	35.8	31
1SMB5942BT3G	942B	48.45	51	53.55	7.3	70	1100	0.25	1	38.8	29
1SMB5943BT3G	943B	53.2	56	58.8	6.7	86	1300	0.25	1	42.6	26
1SMB5944BT3G	944B	58.9	62	65.1	6	100	1500	0.25	1	47.1	24
1SMB5945BT3G	945B	64.6	68	71.4	5.5	120	1700	0.25	1	51.7	22
1SMB5946BT3G	946B	71.25	75	78.75	5	140	2000	0.25	1	56	20
1SMB5947BT3G	947B	77.9	82	86.1	4.6	160	2500	0.25	1	62.2	18
1SMB5948BT3G	948B	86.45	91	95.55	4.1	200	3000	0.25	1	69.2	16
<b>1SMB5949BT3G</b>	<b>949B</b>	<b>95</b>	<b>100</b>	<b>105</b>	<b>3.7</b>	<b>250</b>	<b>3100</b>	<b>0.25</b>	<b>1</b>	<b>76</b>	<b>15</b>
1SMB5951BT3G	951B	114	120	126	3.1	380	4500	0.25	1	91.2	12
1SMB5952BT3G	952B	123.5	130	136.5	2.9	450	5000	0.25	1	98.8	11
1SMB5953BT3G	953B	142.5	150	157.5	2.5	600	6000	0.25	1	114	10
1SMB5954BT3G	954B	152	160	168	2.3	700	6500	0.25	1	121.6	9
1SMB5955BT3G	955B	171	180	189	2.1	900	7000	0.25	1	136.8	8
1SMB5956BT3G	956B	190	200	210	1.9	1200	8000	0.25	1	152	7

2. **TOLERANCE AND TYPE NUMBER DESIGNATION** The type numbers listed indicate a tolerance of  $\pm 5\%$ .

3. **ZENER VOLTAGE ( $V_Z$ ) MEASUREMENT**

Nominal Zener voltage is measured with the device junction in thermal equilibrium with ambient temperature at  $25^\circ\text{C}$ .

4. **ZENER IMPEDANCE ( $Z_Z$ ) DERIVATION**  $Z_{ZT}$  and  $Z_{ZK}$  are measured by dividing the ac voltage drop across the device by the ac current applied. The specified limits are for  $I_{Z(ac)} = 0.1 I_{Z(dc)}$  with the ac frequency = 60 Hz.

\*Include SZ-prefix devices where applicable.

# 1SMB59xxBT3G Series, SZ1SMB59xxT3G Series



Figure 1. Steady State Power Derating

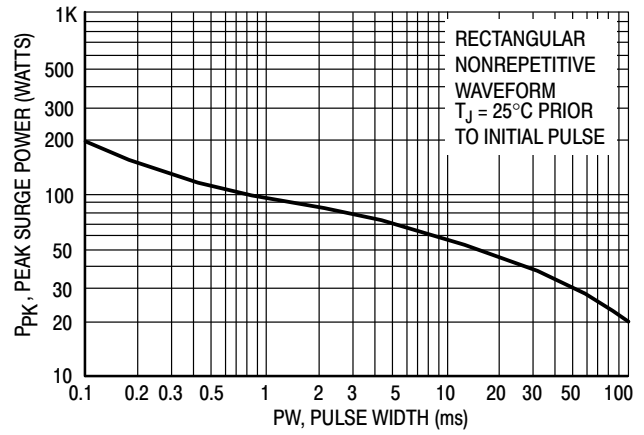

Figure 2. Maximum Surge Power



Figure 3. Zener Voltage - To 12 Volts

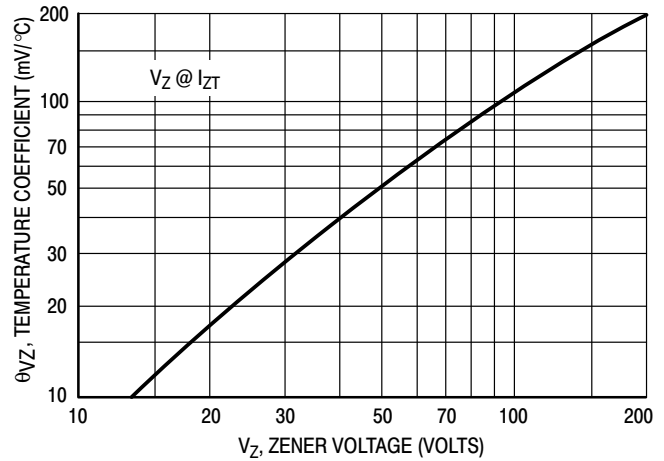

Figure 4. Zener Voltage - 14 To 200 Volts



Figure 5.  $V_Z = 3.3$  thru 10 Volts

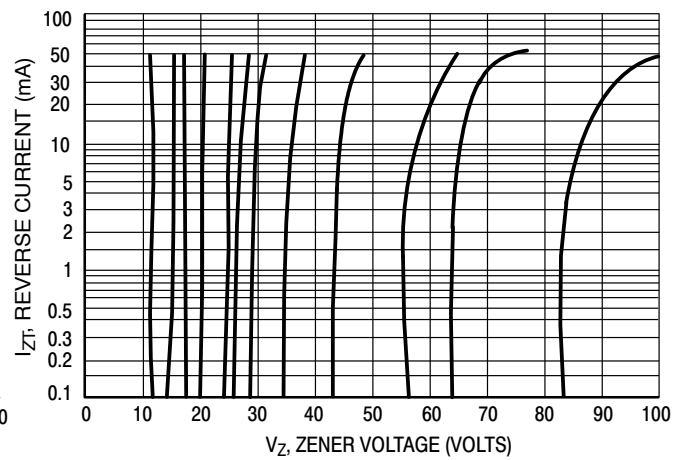

Figure 6.  $V_Z = 12$  thru 82 Volts

# 1SMB59xxBT3G Series, SZ1SMB59xxT3G Series

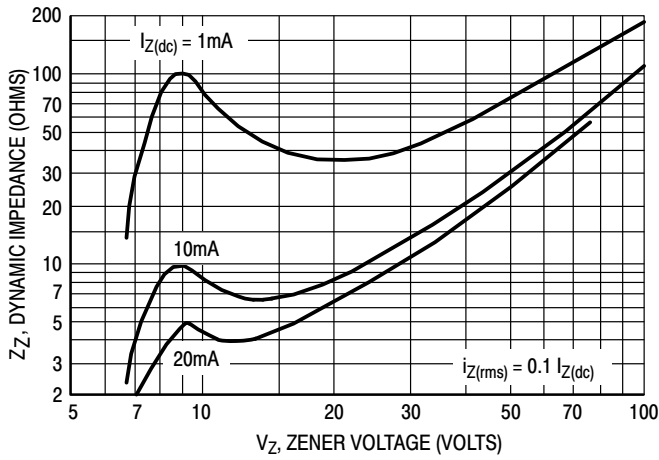

Figure 7. Effect of Zener Voltage

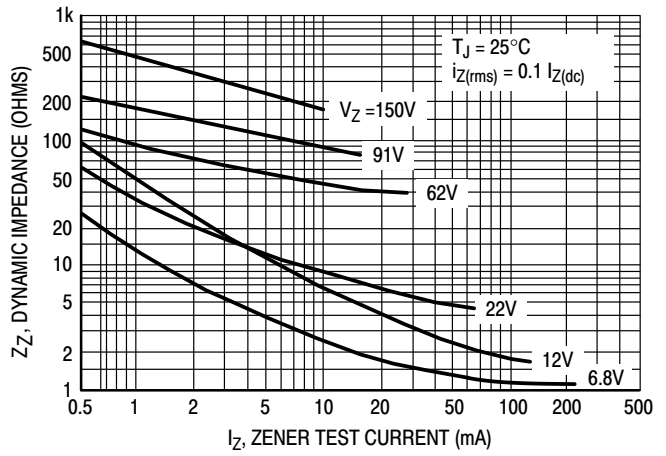

Figure 8. Effect of Zener Current

## Rating and Typical Characteristic Curves ( $T_A = 25^\circ\text{C}$ )

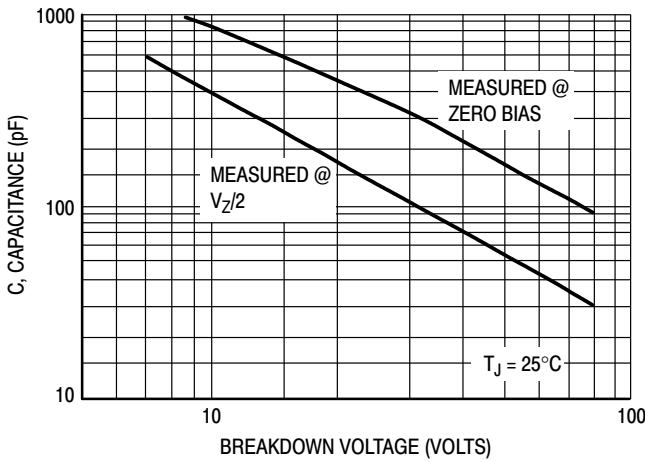

Figure 9. Capacitance Curve



Figure 10. Typical Pulse Rating Curve



Figure 11. Pulse Waveform

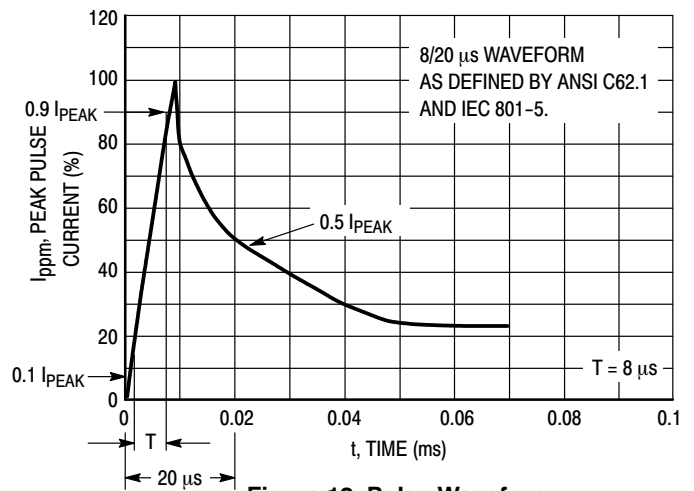

Figure 12. Pulse Waveform

# MECHANICAL CASE OUTLINE

## PACKAGE DIMENSIONS

ON Semiconductor®



SCALE 1:1

Polarity Band



SCALE 1:1

Non-Polarity Band

**SMB**  
CASE 403A-03  
ISSUE J

DATE 19 JUL 2012

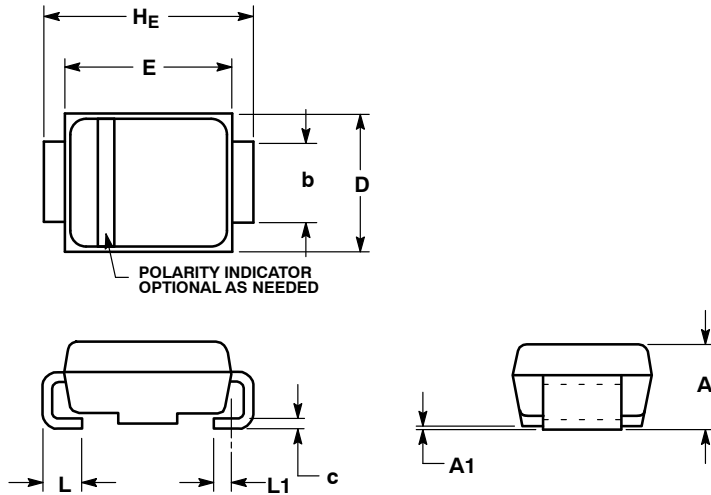

NOTES:

1. DIMENSIONING AND TOLERANCING PER ANSI Y14.5M, 1982.
2. CONTROLLING DIMENSION: INCH.
3. DIMENSION b SHALL BE MEASURED WITHIN DIMENSION L1.

DIM	MILLIMETERS			INCHES		
	MIN	NOM	MAX	MIN	NOM	MAX
A	1.95	2.30	2.47	0.077	0.091	0.097
A1	0.05	0.10	0.20	0.002	0.004	0.008
b	1.96	2.03	2.20	0.077	0.080	0.087
c	0.15	0.23	0.31	0.006	0.009	0.012
D	3.30	3.56	3.95	0.130	0.140	0.156
E	4.06	4.32	4.60	0.160	0.170	0.181
HE	5.21	5.44	5.60	0.205	0.214	0.220
L	0.76	1.02	1.60	0.030	0.040	0.063
L1	0.51 REF			0.020 REF		

**GENERIC MARKING DIAGRAM\***

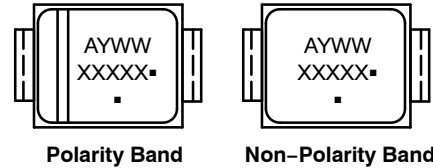

- XXXXX = Specific Device Code
  - A = Assembly Location
  - Y = Year
  - WW = Work Week
  - = Pb-Free Package
- (Note: Microdot may be in either location)

\*This information is generic. Please refer to device data sheet for actual part marking. Pb-Free indicator, "G" or microdot "▪", may or may not be present.

**SOLDERING FOOTPRINT\***

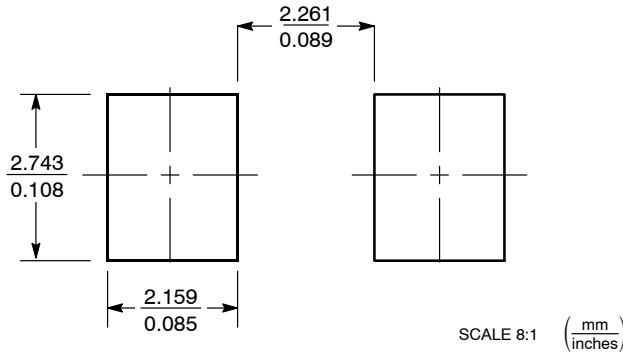

\*For additional information on our Pb-Free strategy and soldering details, please download the ON Semiconductor Soldering and Mounting Techniques Reference Manual, SOLDERRM/D.

<b>DOCUMENT NUMBER:</b>	<b>98ASB42669B</b>	Electronic versions are uncontrolled except when accessed directly from the Document Repository. Printed versions are uncontrolled except when stamped "CONTROLLED COPY" in red.
<b>DESCRIPTION:</b>	<b>SMB</b>	<b>PAGE 1 OF 1</b>

ON Semiconductor and ON are trademarks of Semiconductor Components Industries, LLC dba ON Semiconductor or its subsidiaries in the United States and/or other countries. ON Semiconductor reserves the right to make changes without further notice to any products herein. ON Semiconductor makes no warranty, representation or guarantee regarding the suitability of its products for any particular purpose, nor does ON Semiconductor assume any liability arising out of the application or use of any product or circuit, and specifically disclaims any and all liability, including without limitation special, consequential or incidental damages. ON Semiconductor does not convey any license under its patent rights nor the rights of others.

**onsemi**, **Onsemi**, and other names, marks, and brands are registered and/or common law trademarks of Semiconductor Components Industries, LLC dba "**onsemi**" or its affiliates and/or subsidiaries in the United States and/or other countries. **onsemi** owns the rights to a number of patents, trademarks, copyrights, trade secrets, and other intellectual property. A listing of **onsemi**'s product/patent coverage may be accessed at [www.onsemi.com/site/pdf/Patent-Marking.pdf](http://www.onsemi.com/site/pdf/Patent-Marking.pdf). **onsemi** reserves the right to make changes at any time to any products or information herein, without notice. The information herein is provided "as-is" and **onsemi** makes no warranty, representation or guarantee regarding the accuracy of the information, product features, availability, functionality, or suitability of its products for any particular purpose, nor does **onsemi** assume any liability arising out of the application or use of any product or circuit, and specifically disclaims any and all liability, including without limitation special, consequential or incidental damages. Buyer is responsible for its products and applications using **onsemi** products, including compliance with all laws, regulations and safety requirements or standards, regardless of any support or applications information provided by **onsemi**. "Typical" parameters which may be provided in **onsemi** data sheets and/or specifications can and do vary in different applications and actual performance may vary over time. All operating parameters, including "Typicals" must be validated for each customer application by customer's technical experts. **onsemi** does not convey any license under any of its intellectual property rights nor the rights of others. **onsemi** products are not designed, intended, or authorized for use as a critical component in life support systems or any FDA Class 3 medical devices or medical devices with a same or similar classification in a foreign jurisdiction or any devices intended for implantation in the human body. Should Buyer purchase or use **onsemi** products for any such unintended or unauthorized application, Buyer shall indemnify and hold **onsemi** and its officers, employees, subsidiaries, affiliates, and distributors harmless against all claims, costs, damages, and expenses, and reasonable attorney fees arising out of, directly or indirectly, any claim of personal injury or death associated with such unintended or unauthorized use, even if such claim alleges that **onsemi** was negligent regarding the design or manufacture of the part. **onsemi** is an Equal Opportunity/Affirmative Action Employer. This literature is subject to all applicable copyright laws and is not for resale in any manner.

## PUBLICATION ORDERING INFORMATION

### LITERATURE FULFILLMENT:

Email Requests to: [orderlit@onsemi.com](mailto:orderlit@onsemi.com)

**onsemi Website:** [www.onsemi.com](http://www.onsemi.com)

### TECHNICAL SUPPORT

**North American Technical Support:**

Voice Mail: 1 800-282-9855 Toll Free USA/Canada

Phone: 011 421 33 790 2910

**Europe, Middle East and Africa Technical Support:**

Phone: 00421 33 790 2910

For additional information, please contact your local Sales Representative