

**Power Block**
**Features**

- Dual asymmetric N-channel OptiMOS™5 MOSFET
- Logic level (4.5V rated)
- Optimized for high performance buck converters
- Qualified according to JEDEC<sup>1)</sup> for target applications
- Pb-free lead plating; RoHS compliant
- Halogen-free according to IEC61249-2-21

**Product Summary**

		Q1	Q2	
$V_{DS}$		25	25	V
$R_{DS(on),max}$	$V_{GS}=10\text{ V}$	3	0.8	mΩ
	$V_{GS}=4.5\text{ V}$	4	1.1	
$I_D$		50	50	A

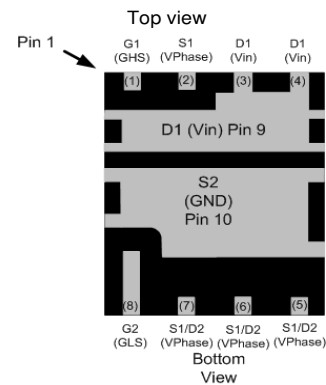
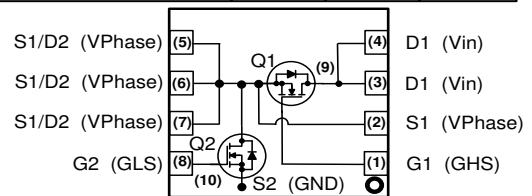

Type	Package	Marking
BSG0811ND	PG-TISON8-4	0811ND

**Maximum ratings, at  $T_j=25\text{ °C}$ , unless otherwise specified <sup>2)</sup>**

Parameter	Symbol	Conditions	Value		Unit
			Q1	Q2	
Continuous drain current	$I_D$	$T_C=70\text{ °C}, V_{GS}=10\text{ V}$	50	50	A
		$T_C=70\text{ °C}, V_{GS}=4.5\text{ V}$	50	50	
		$T_A=25\text{ °C}, V_{GS}=4.5\text{ V}^{3)}$	31	50	
		$T_A=25\text{ °C}, V_{GS}=4.5\text{ V}^{4)}$	19	41	
Pulsed drain current	$I_{D,pulse}$	$T_C=70\text{ °C}$	160	160	
Avalanche energy, single pulse	$E_{AS}$	Q1: $I_D=10\text{ A}$ , Q2: $I_D=20\text{ A}$ , $R_{GS}=25\text{ Ω}$	30	160	mJ
Gate source voltage	$V_{GS}$		±16		V
Power dissipation	$P_{tot}$	$T_A=25\text{ °C}^{3)}$	6.25	6.25	W
		$T_A=25\text{ °C}^{4)}$	2.5	2.5	
Operating and storage temperature	$T_j, T_{stg}$		-55 ... 150		°C
IEC climatic category; DIN IEC 68-1			55/150/56		

<sup>1)</sup> J-STD20 and JESD22

Parameter	Symbol	Conditions	Values			Unit
			min.	typ.	max.	

**Thermal characteristics**

Thermal resistance, junction - case	Q1	$R_{thJC}$		-	-	4.3	K/W
	Q2			-	-	1.8	
Thermal resistance, junction - ambient <sup>2)</sup>	Q1	$R_{thJA}$	application specific board <sup>3)</sup>	-	-	20	
	Q2						
	Q1	6 cm <sup>2</sup> cooling area <sup>4)</sup>	-	-	50		
	Q2						

**Electrical characteristics, at  $T_j=25\text{ °C}$ , unless otherwise specified**
**Static characteristics**

Drain-source breakdown voltage	Q1	$V_{(BR)DSS}$	$V_{GS}=0\text{ V}, I_D=1\text{ mA}$	25 <sup>6)</sup>	-	-	V
	Q2						
Gate threshold voltage	Q1	$V_{GS(th)}$	$V_{DS}=V_{GS}, I_D=250\text{ }\mu\text{A}$	1.2	1.6	2	
	Q2						
Zero gate voltage drain current	Q1	$I_{DSS}$	$V_{DS}=25\text{ V}, V_{GS}=0\text{ V}, T_j=25\text{ °C}$	-	-	1	$\mu\text{A}$
	Q2						
	Q1	$V_{DS}=25\text{ V}, V_{GS}=0\text{ V}, T_j=150\text{ °C}$	-	-	100		
	Q2						
Gate-source leakage current	Q1	$I_{GSS}$	$V_{GS}=20\text{ V}, V_{DS}=0\text{ V}$	-	-	100	nA
	Q2						
Drain-source on-state resistance	Q1	$R_{DS(on)}$	$V_{GS}=4.5\text{ V}, I_D=20\text{ A}$	-	3.2	4.0	m $\Omega$
	Q2						
	Q1	$V_{GS}=10\text{ V}, I_D=20\text{ A}$	-	2.4	3.0		
	Q2					-	
Gate resistance	Q1	$R_G$		-	0.7	1.2	$\Omega$
	Q2						
Transconductance	Q1	$g_{fs}$	$ V_{DS} >2 I_D R_{DS(on)max}, I_D=20\text{ A}$	46	93	-	S
	Q2						

<sup>2)</sup> Only one of both transistors active

<sup>3)</sup> 8 Layers copper 70 $\mu\text{m}$  thickness. PCB in still air.

<sup>4)</sup> Device on 40 mm x 40 mm x 1.5 mm epoxy PCB FR4 with 6 cm<sup>2</sup> (one layer, 70  $\mu\text{m}$  thick) copper area for drain connection. PCB is vertical in still air.

Parameter	Symbol	Conditions	Values			Unit
			min.	typ.	max.	

**Dynamic characteristics**

Input capacitance	Q1	$C_{iss}$	$V_{GS}=0\text{ V},$ $V_{DS}=12\text{ V}, f=1\text{ MHz}$	-	780	1100	pF
	Q2			-	2700	3700	
Output capacitance	Q1	$C_{oss}$		-	390	520	
	Q2			-	1400	1900	
Reverse transfer capacitance	Q1	$C_{rss}$		-	38	-	
	Q2			-	130	-	
Turn-on delay time	Q1	$t_{d(on)}$	$V_{IN}=12\text{ V},$ $V_{DRV}=5\text{ V},$ $F_{SW}=500\text{ KHz},$ $I_{OUT}=30\text{ A}^{5)}$	-	4.3	-	ns
	Q2			-	5.6	-	
Rise time	Q1	$t_r$		-	4.7	-	
	Q2			-	4.3	-	
Turn-off delay time	Q1	$t_{d(off)}$		-	4.3	-	
	Q2			-	8.8	-	
Fall time	Q1	$t_f$		-	1.4	-	
	Q2			-	2.6	-	

**Gate Charge Characteristics**

Gate to source charge	Q1	$Q_{gs}$	$V_{DD}=12\text{ V},$ $I_D=30\text{ A},$ $V_{GS}=0\text{ to }4.5\text{ V}$	-	2.0	-	nC	
Gate to drain charge		$Q_{gd}$		-	1.4	-		
Gate charge total		$Q_g$		-	5.6	8.4		
Gate plateau voltage		$V_{plateau}$		-	2.6	-		V
Gate to source charge	Q2	$Q_{gs}$		$V_{DD}=12\text{ V},$ $I_D=30\text{ A},$ $V_{GS}=0\text{ to }4.5\text{ V}$	-	6.4	-	nC
Gate to drain charge		$Q_{gd}$			-	4.7	-	
Gate charge total		$Q_g$			-	20	29	
Gate plateau voltage		$V_{plateau}$			-	2.3	-	
Output charge	Q1	$Q_{oss}$	$V_{DD}=12\text{ V}, V_{GS}=0\text{ V}$		-	8	-	nC
	Q2				-	27	-	

<sup>5)</sup> For more information see application note n° TBD

<sup>6)</sup> The device can withstand a pulse of not more than 30 V for a duration of up to 2 ns at a frequency of 600 kHz with maximum buck converter input voltage  $V_{IN}=16\text{ V}$ .

Parameter	Symbol	Conditions	Values			Unit
			min.	typ.	max.	

**Reverse Diode**

Diode continuous forward current	Q1	$I_S$	$T_C=25\text{ °C}$	-	-	29	A
	Q2			-	-	50	
Diode pulse current	Q1	$I_{S,pulse}$		-	-	160	
	Q2			-	-	160	
Diode forward voltage	Q1	$V_{SD}$	$V_{GS}=0\text{ V}, I_F=20\text{ A},$ $T_j=25\text{ °C}$	-	0.84	1	V
	Q2			-	0.77	1	
Reverse recovery charge	Q1	$Q_{rr}$	$V_R=12\text{ V}, I_F=I_S,$ $di_F/dt=100\text{ A}/\mu\text{s}$	-	10	-	nC
	Q2			-	20	-	

**1 Power dissipation (Q1)**

$$P_{\text{tot}}=f(T_A)^4$$

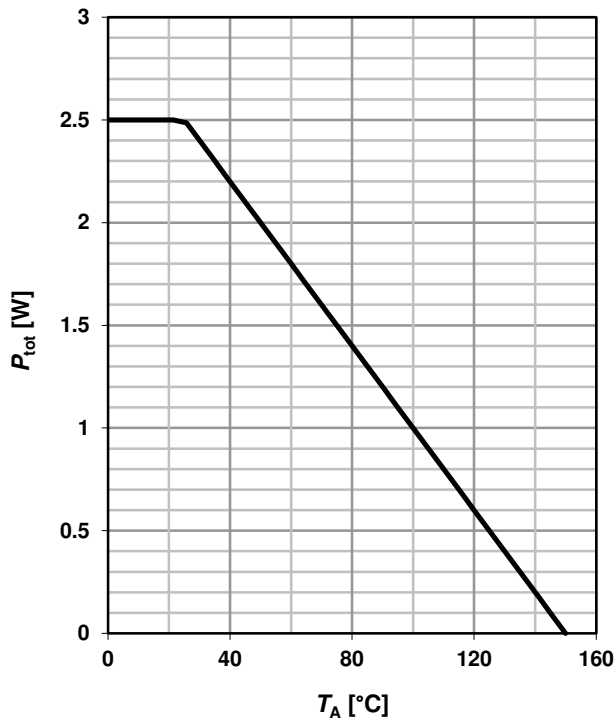

**2 Power dissipation (Q2)**

$$P_{\text{tot}}=f(T_A)^4$$

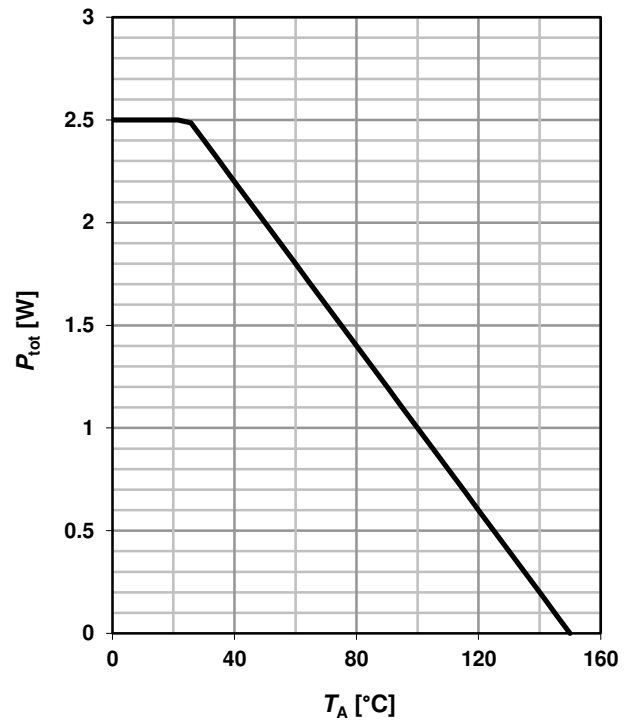

**3 Drain current (Q1)**

$$I_D=f(T_C)$$

parameter:  $V_{GS} \geq 10$  V

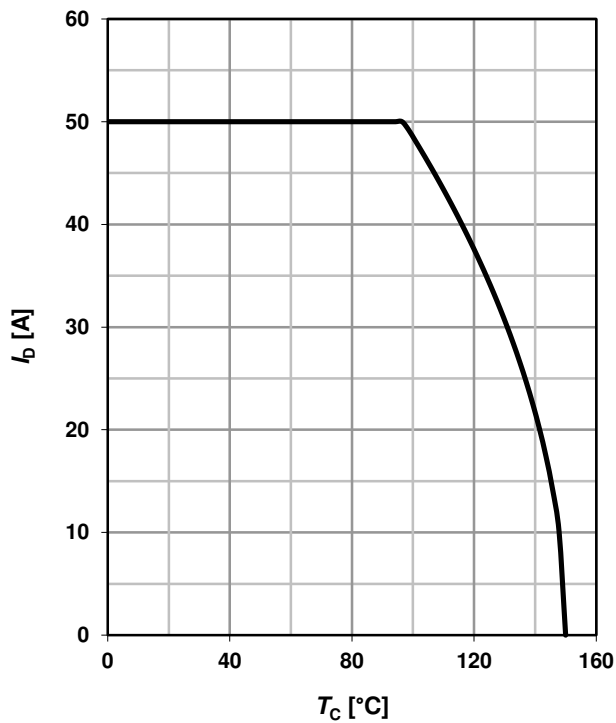

**4 Drain current (Q2)**

$$I_D=f(T_C)$$

parameter:  $V_{GS} \geq 10$  V

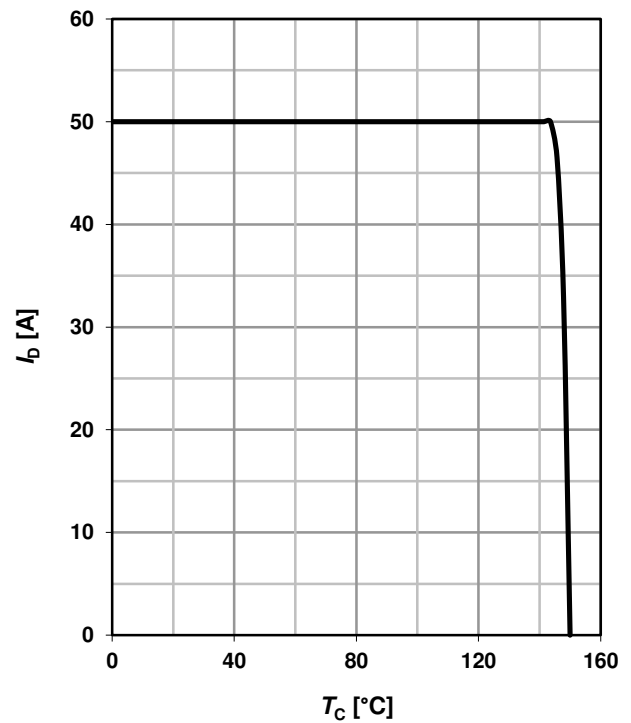

**5 Safe operating area (Q1)**

$I_D=f(V_{DS}); T_C=25\text{ }^\circ\text{C}; D=0$

parameter:  $t_p$

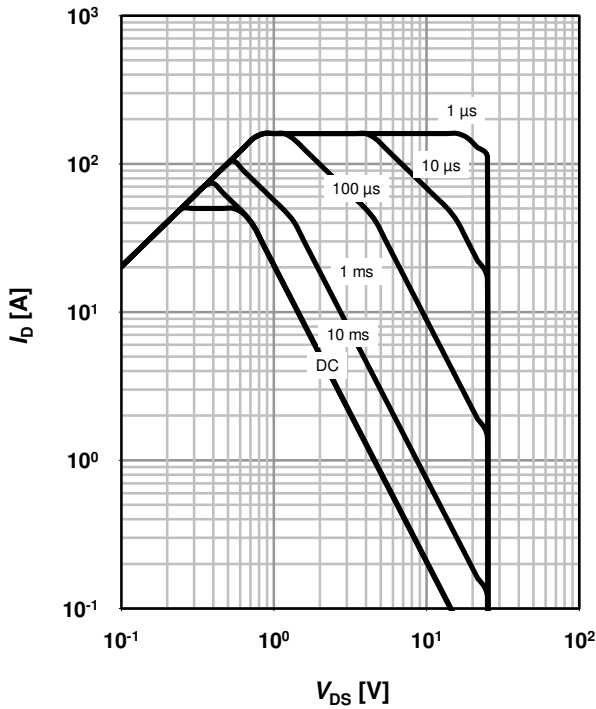

**6 Safe operating area (Q2)**

$I_D=f(V_{DS}); T_C=25\text{ }^\circ\text{C}; D=0$

parameter:  $t_p$

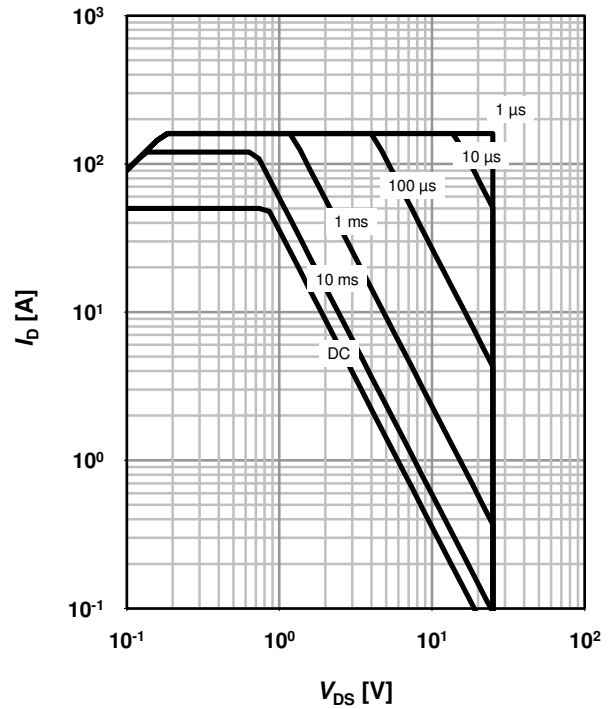

**7 Max. transient thermal impedance (Q1)**

$Z_{thJC}=f(t_p)$

parameter:  $D=t_p/T$

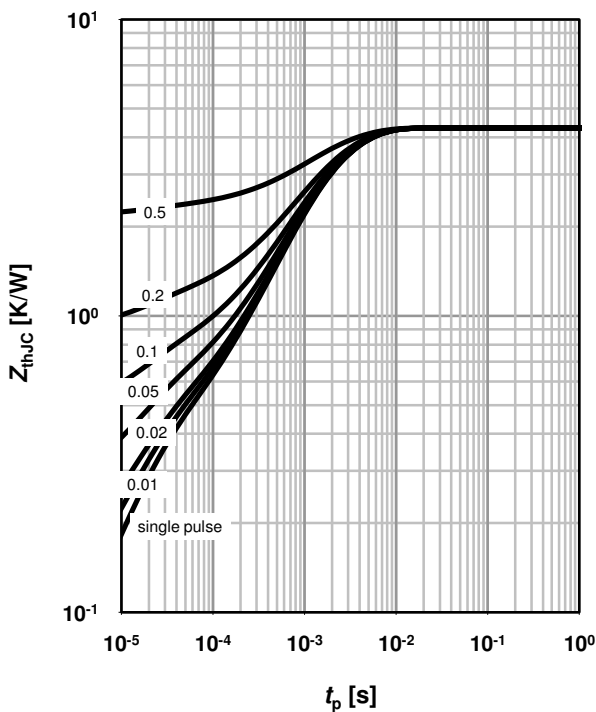

**8 Max. transient thermal impedance (Q2)**

$Z_{thJC}=f(t_p)$

parameter:  $D=t_p/T$

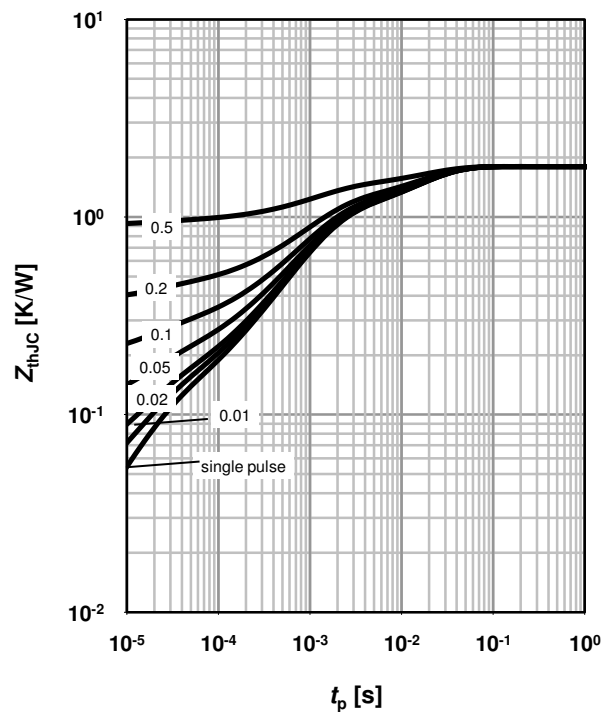

**9 Typ. output characteristics (Q1)**

$I_D=f(V_{DS}); T_j=25\text{ }^\circ\text{C}$

parameter:  $V_{GS}$

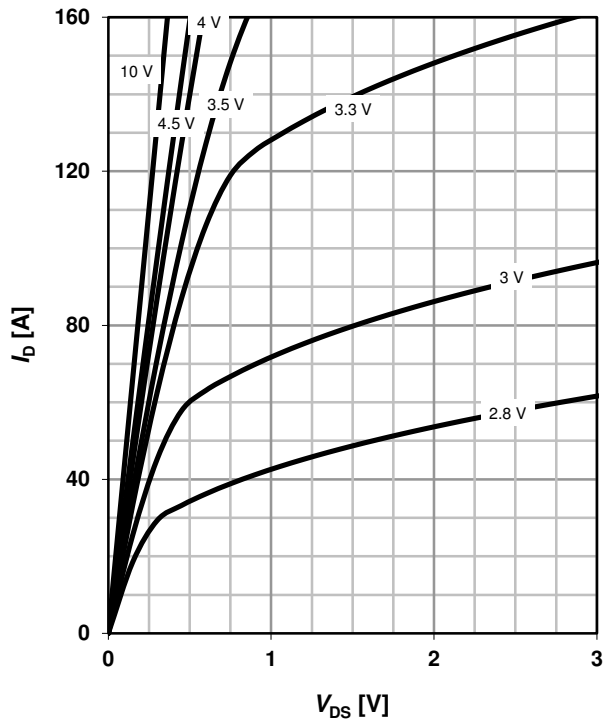

**10 Typ. output characteristics (Q2)**

$I_D=f(V_{DS}); T_j=25\text{ }^\circ\text{C}$

parameter:  $V_{GS}$

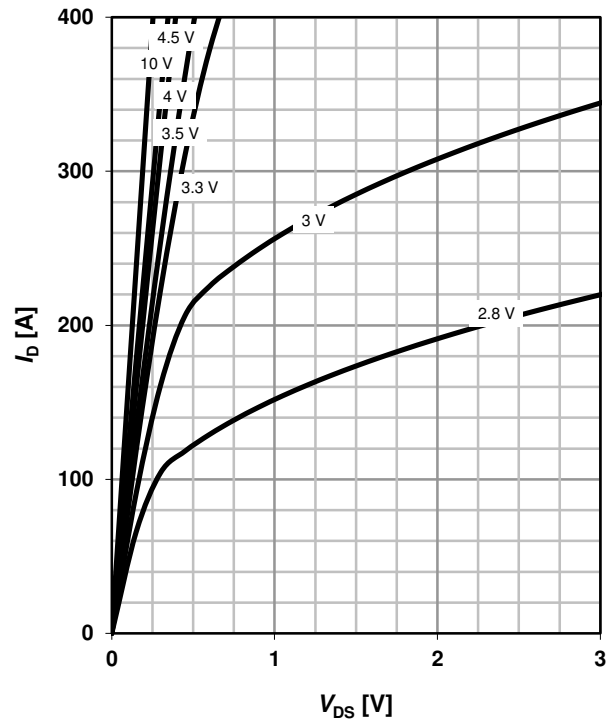

**11 Typ. drain-source on resistance (Q1)**

$R_{DS(on)}=f(I_D); T_j=25\text{ }^\circ\text{C}$

parameter:  $V_{GS}$

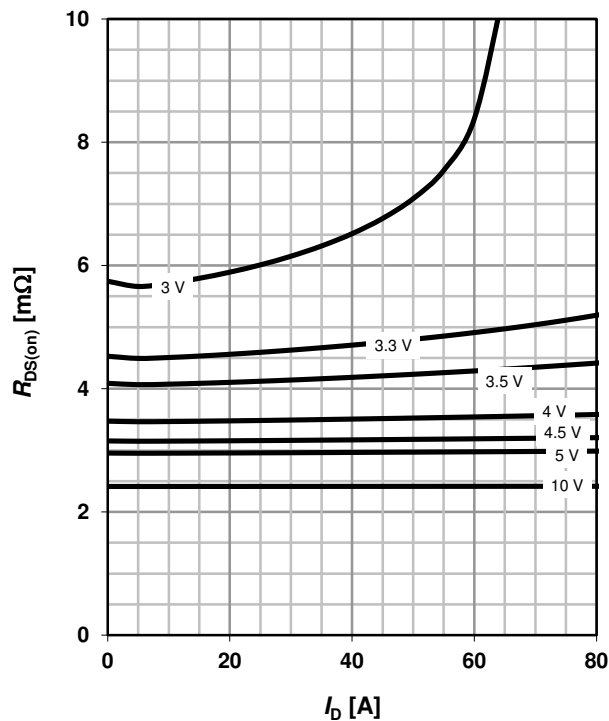

**12 Typ. drain-source on resistance (Q2)**

$R_{DS(on)}=f(I_D); T_j=25\text{ }^\circ\text{C}$

parameter:  $V_{GS}$

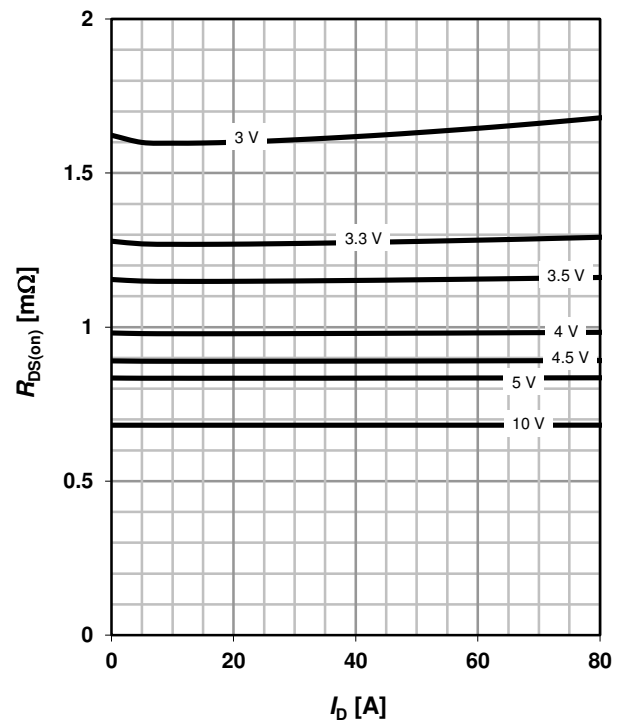

**13 Typ. transfer characteristics (Q1)**

$$I_D = f(V_{GS}); |V_{DS}| > 2 |I_D| R_{DS(on)max}$$

parameter:  $T_j$

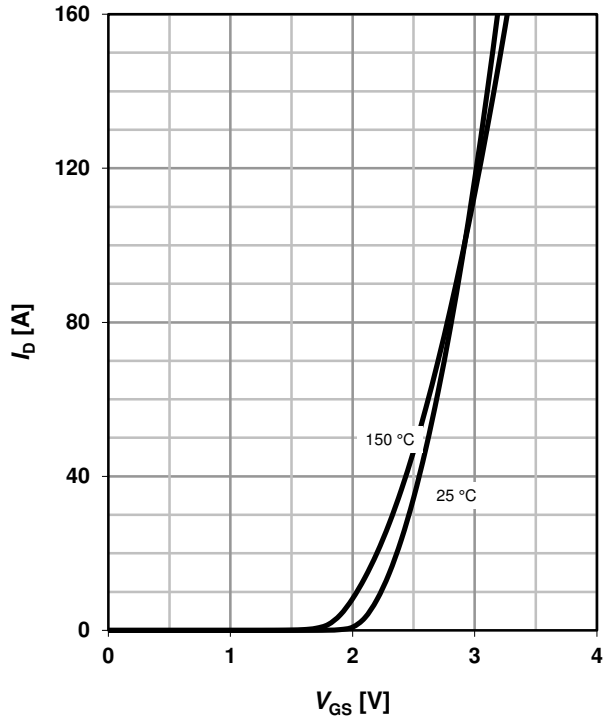

**14 Typ. transfer characteristics (Q2)**

$$I_D = f(V_{GS}); |V_{DS}| > 2 |I_D| R_{DS(on)max}$$

parameter:  $T_j$

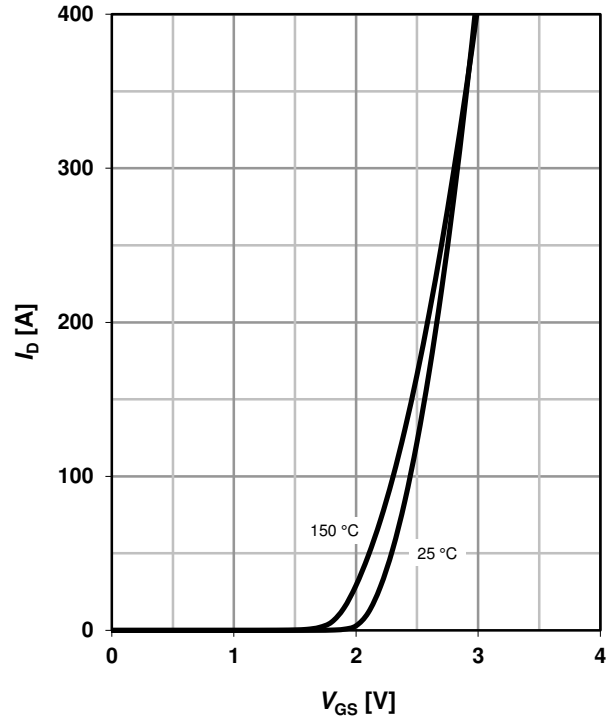

**15 Drain-source on-state resistance (Q1)**

$$R_{DS(on)} = f(T_j); I_D = 20 \text{ A}; V_{GS} = 10 \text{ V}$$

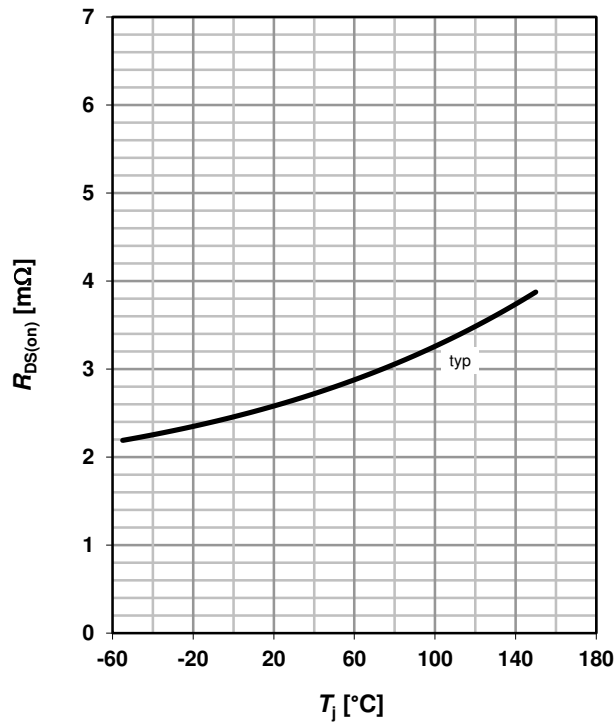

**16 Drain-source on-state resistance (Q2)**

$$R_{DS(on)} = f(T_j); I_D = 20 \text{ A}; V_{GS} = 10 \text{ V}$$

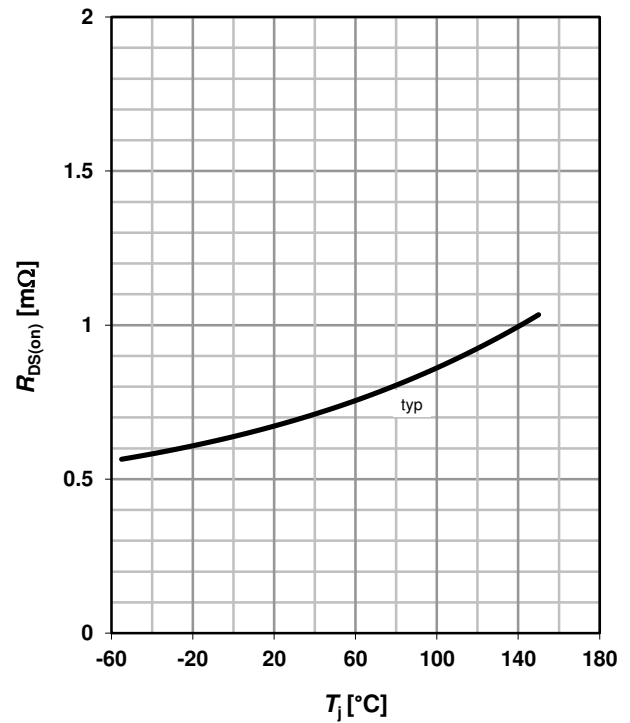



**17 Typ. gate threshold voltage (Q1)**

$V_{GS(th)}=f(T_j)$ ;  $V_{GS}=V_{DS}$ ;  $I_D=250 \mu A$

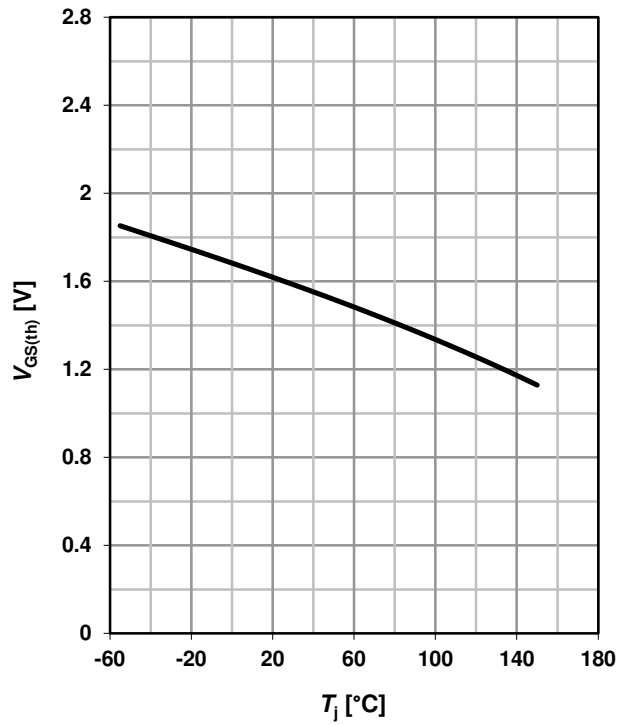

**18 Typ. gate threshold voltage (Q2)**

$V_{GS(th)}=f(T_j)$ ;  $V_{GS}=V_{DS}$ ;  $I_D=250 \mu A$

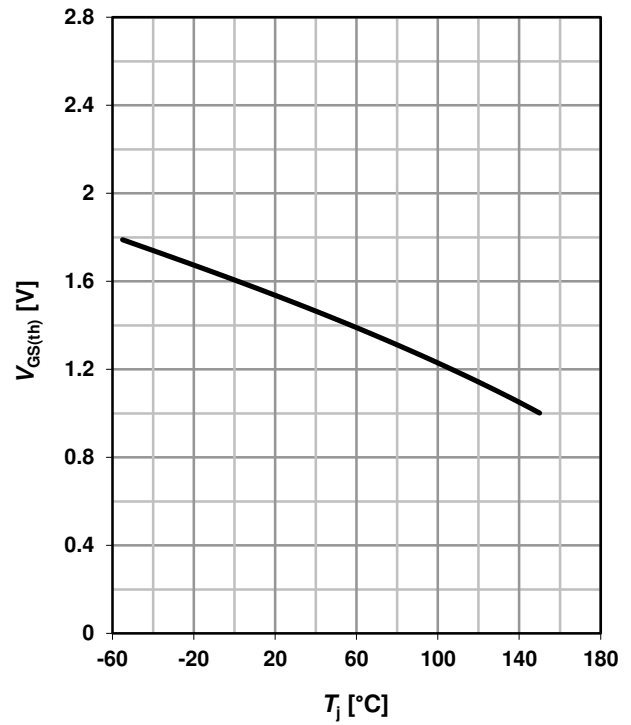

**19 Typ. capacitances (Q1)**

$C=f(V_{DS})$ ;  $V_{GS}=0 V$ ;  $f=1 MHz$

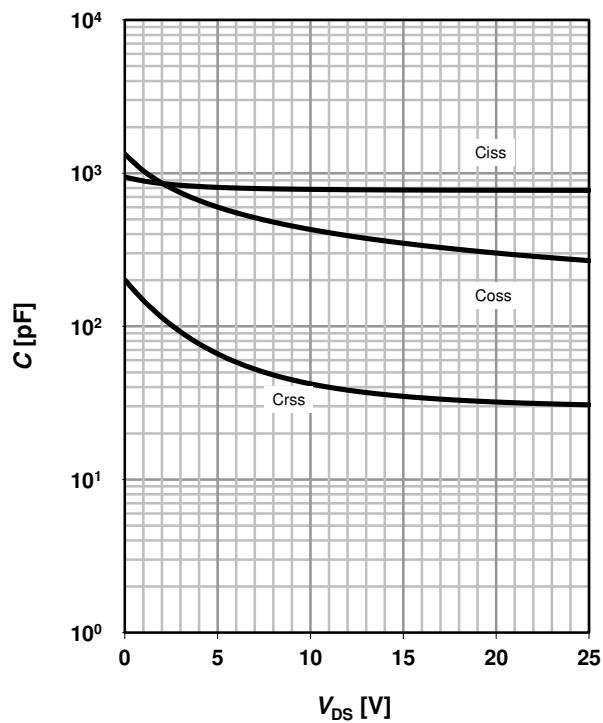

**20 Typ. capacitances (Q2)**

$C=f(V_{DS})$ ;  $V_{GS}=0 V$ ;  $f=1 MHz$

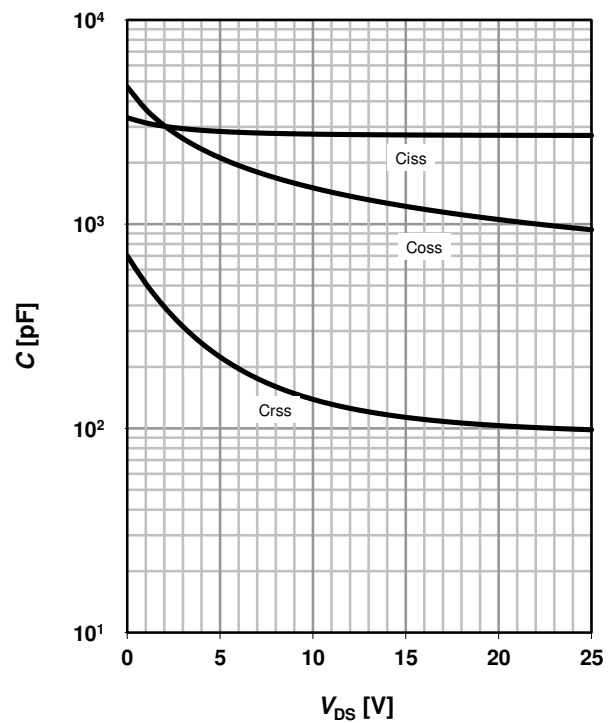

**21 Forward characteristics of reverse diode (Q1)**

$I_F=f(V_{SD})$

parameter:  $T_j$

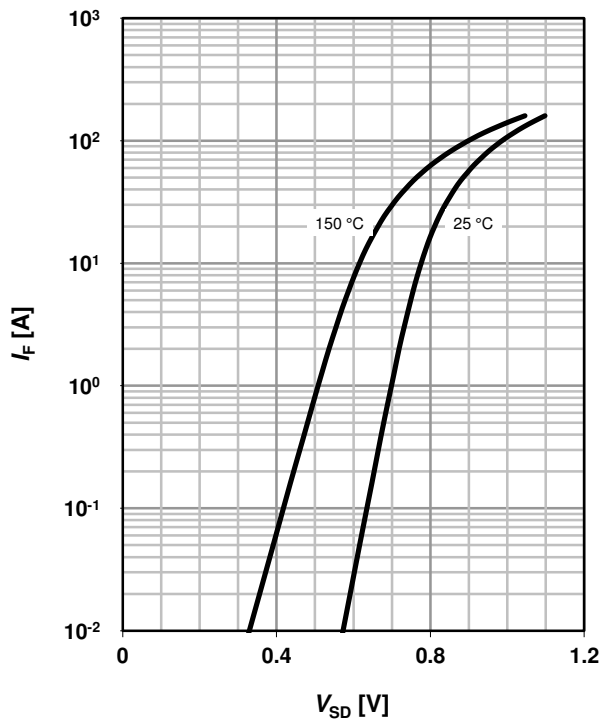

**22 Forward characteristics of reverse diode (Q2)**

$I_F=f(V_{SD})$

parameter:  $T_j$

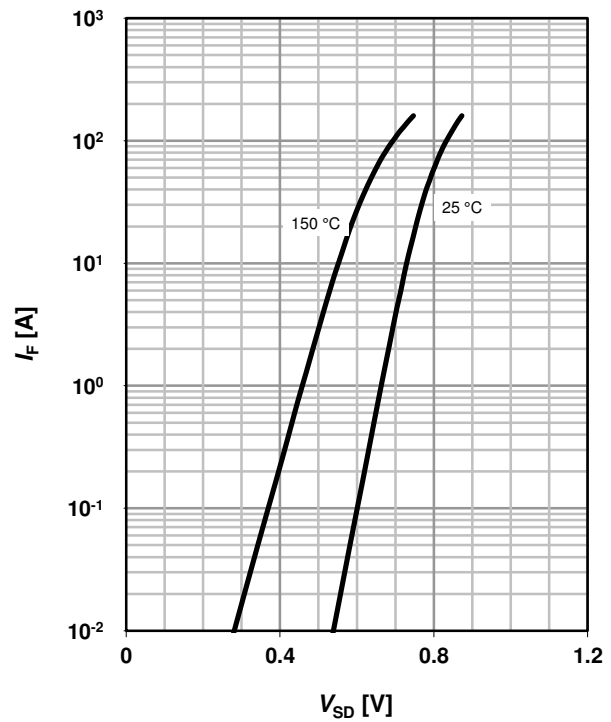

**23 Avalanche characteristics (Q1)**

$I_{AS}=f(t_{AV}); R_{GS}=25 \Omega$

parameter:  $T_{j(start)}$

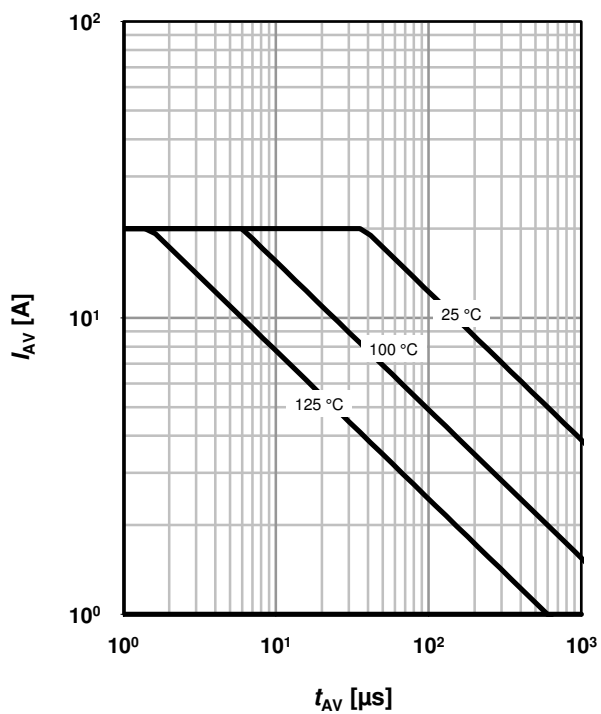

**24 Avalanche characteristics (Q2)**

$I_{AS}=f(t_{AV}); R_{GS}=25 \Omega$

parameter:  $T_{j(start)}$

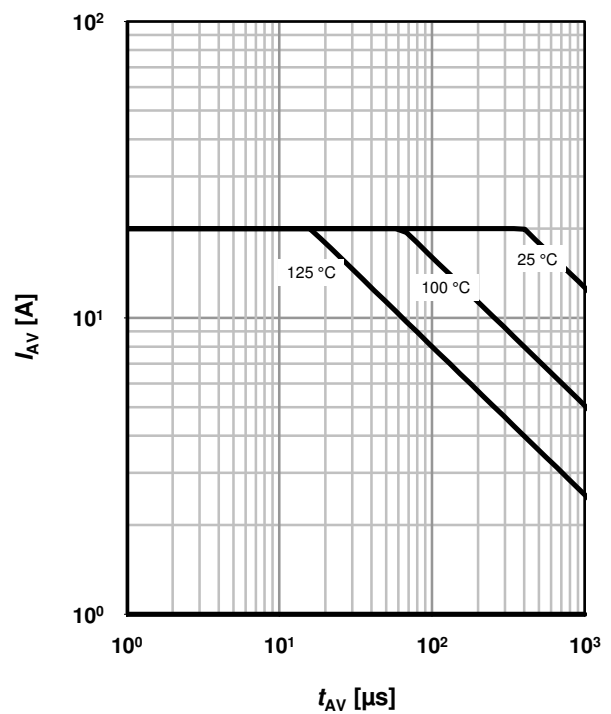

**25 Typ. gate charge (Q1)**

$V_{GS}=f(Q_{gate}); I_D=20\text{ A pulsed}$

parameter:  $V_{DD}$

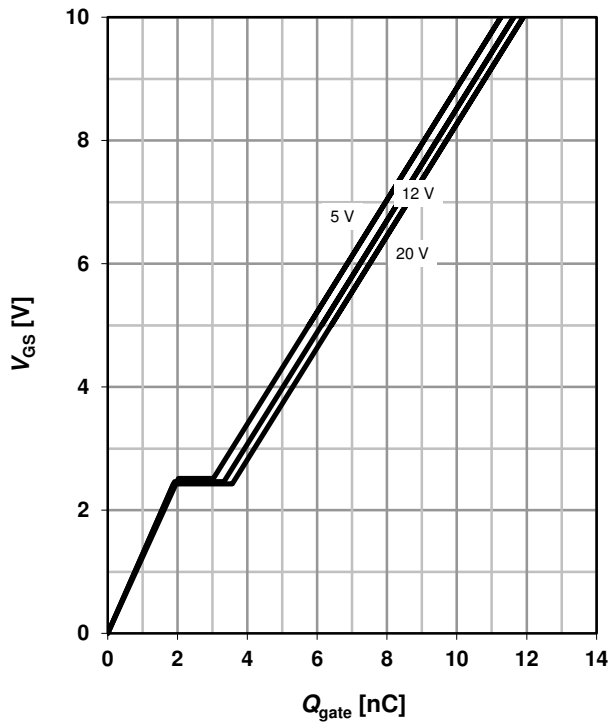

**26 Typ. gate charge (Q2)**

$V_{GS}=f(Q_{gate}); I_D=20\text{ A pulsed}$

parameter:  $V_{DD}$

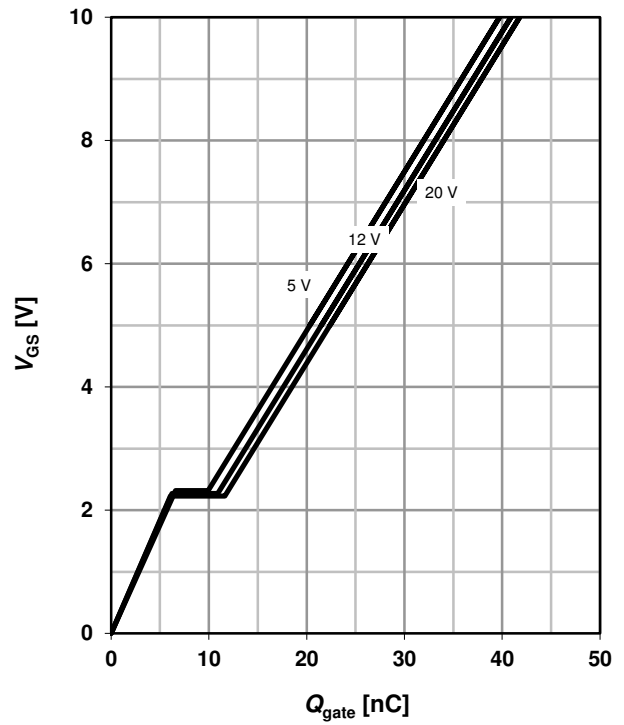

**27 Drain-source breakdown voltage (Q1)**

$V_{BR(DSS)}=f(T_j); I_D=1\text{ mA}$

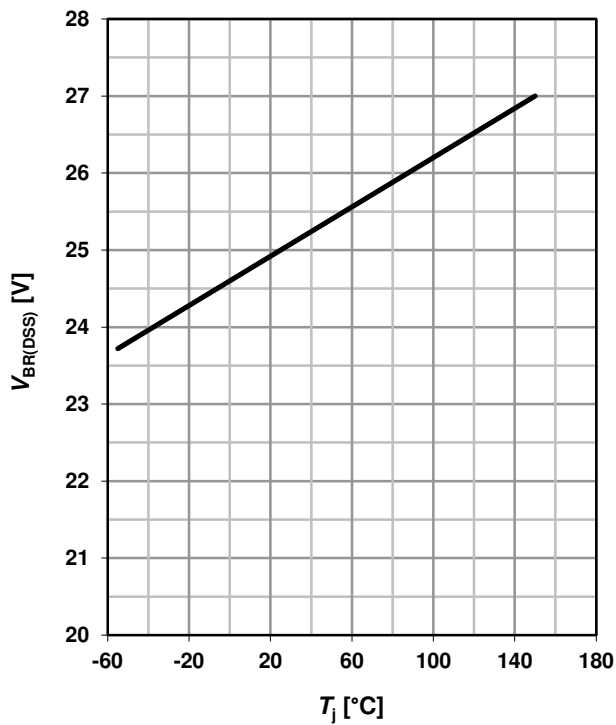

**28 Drain-source breakdown voltage (Q2)**

$V_{BR(DSS)}=f(T_j); I_D=1\text{ mA}$

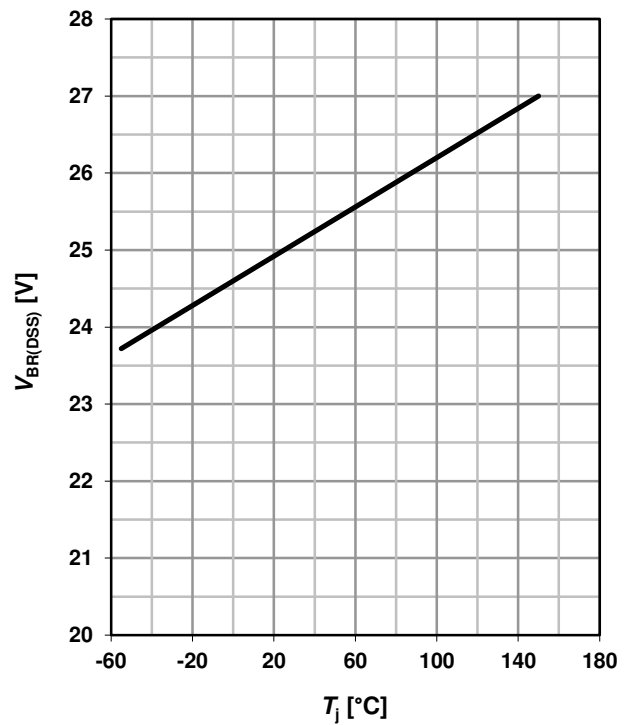

Package Outline

PG-TISON8-4

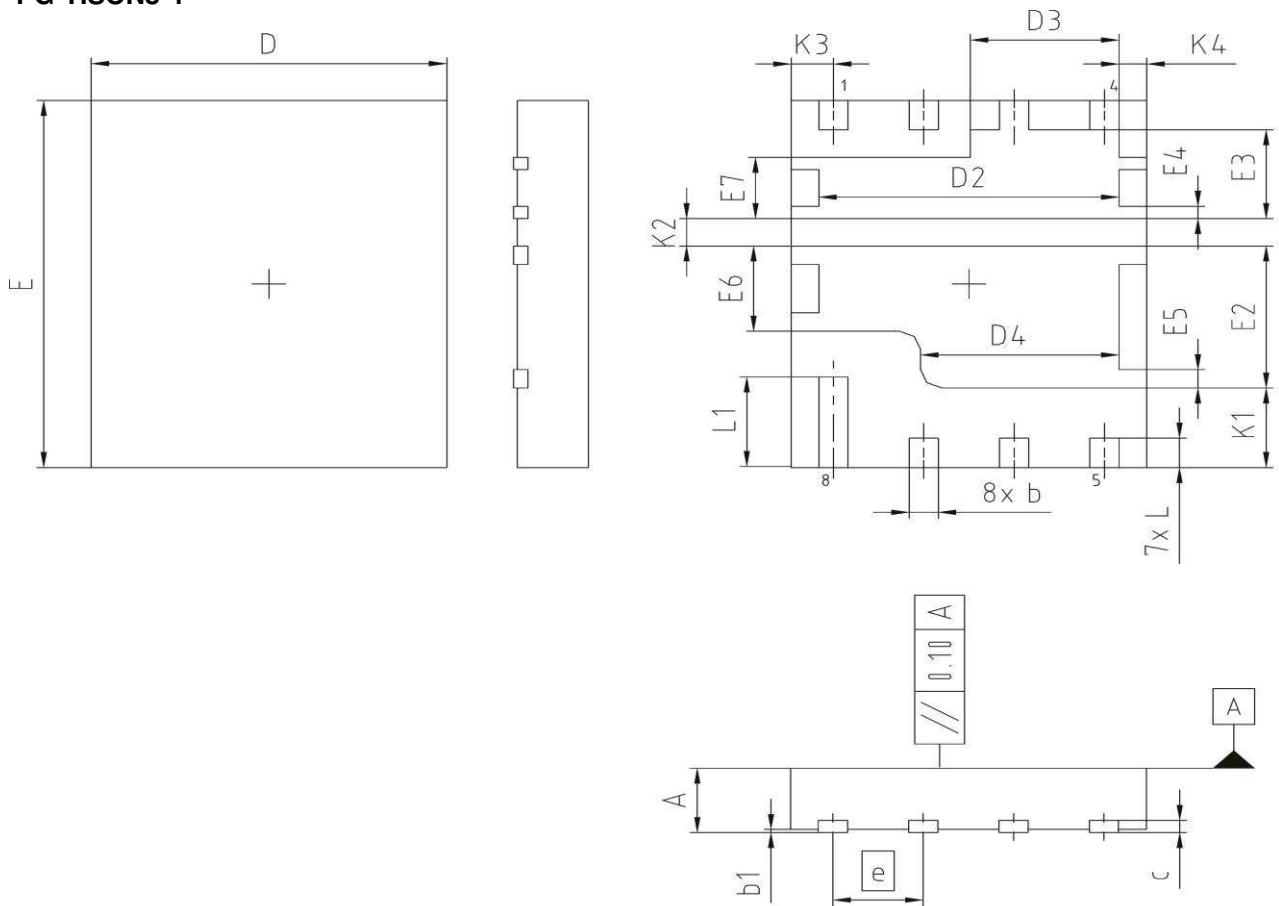

DIM	MILLIMETERS		INCHES	
	MIN	MAX	MIN	MAX
A	0.90	1.15	0.035	0.045
b	0.31	0.51	0.012	0.020
b1	0.00	0.05	0.000	0.002
c	0.10	0.30	0.004	0.012
D	4.90	5.10	0.193	0.201
D2	4.12	4.32	0.162	0.170
D3	1.99	2.19	0.078	0.086
D4	2.69	2.89	0.106	0.114
E	5.90	6.10	0.232	0.240
E2	2.22	2.42	0.087	0.095
E3	1.35	1.55	0.053	0.061
E4	0.10	0.30	0.004	0.012
E5	0.20	0.40	0.008	0.016
E6	1.29	1.49	0.051	0.059
E7	0.90	1.10	0.035	0.043
e	1.27 (BSC)		0.05 (BSC)	
N	8		8	
L	0.38	0.58	0.015	0.023
L1	1.38	1.58	0.054	0.062
K1	1.38	1.58	0.054	0.062
K2	0.35	0.55	0.014	0.022
K3	0.50	0.70	0.020	0.028
K4	0.29	0.49	0.011	0.019

DOCUMENT NO.  
Z8B00176527

SCALE

EUROPEAN PROJECTION

ISSUE DATE  
09-08-2017

REVISION  
02

Boardpads & Apertures

PG-TISON8-4

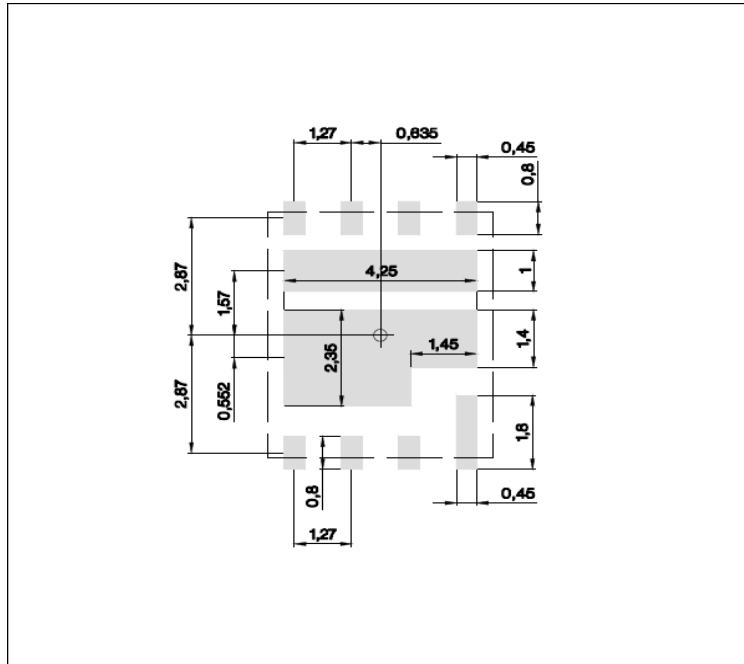

■ copper

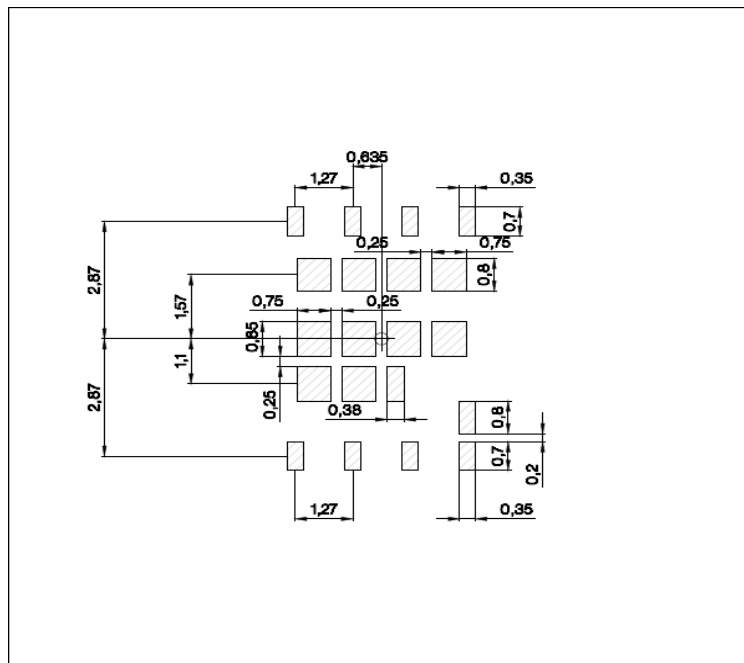

▨ stencil apertures

All the dimensions in mm

## Revision History

BSG0811ND

**Revision: 2017-08-25, Rev. 2.2**

Previous Revision

Revision	Date	Subjects (major changes since last revision)
2.0	2015-03-17	Release of final version
2.1	2016-03-24	Update package drawing
2.2	2017-08-25	Update package outline

### Trademarks of Infineon Technologies AG

AURIX™, C166™, CanPAK™, CIPOS™, CoolGaN™, CoolMOS™, CoolSET™, CoolSiC™, CORECONTROL™, CROSSAVE™, DAVE™, DI-POL™, DrBlade™, EasyPIM™, EconoBRIDGE™, EconoDUAL™, EconoPACK™, EconoPIM™, EiceDRIVER™, eupec™, FCOS™, HITFET™, HybridPACK™, Infineon™, ISOFACE™, IsoPACK™, i-Wafer™, MIPAQ™, ModSTACK™, my-d™, NovalithIC™, OmniTune™, OPTIGA™, OptiMOS™, ORIGA™, POWERCODE™, PRIMARION™, PrimePACK™, PrimeSTACK™, PROFET™, PRO-SIL™, RASIC™, REAL3™, ReverSave™, SatRIC™, SIEGET™, SiPMOS™, SmartLEWIS™, SOLID FLASH™, SPOC™, TEMPFET™, thinQ!™, TRENCHSTOP™, TriCore™.

Trademarks updated August 2015

### Other Trademarks

All referenced product or service names and trademarks are the property of their respective owners.

### We Listen to Your Comments

Any information within this document that you feel is wrong, unclear or missing at all? Your feedback will help us to continuously improve the quality of this document. Please send your proposal (including a reference to this document) to: [erratum@infineon.com](mailto:erratum@infineon.com)

**Published by**  
**Infineon Technologies AG**  
**81726 München, Germany**  
**© 2017 Infineon Technologies AG**  
**All Rights Reserved.**

### Legal Disclaimer

The information given in this document shall in no event be regarded as a guarantee of conditions or characteristics ("Beschaffensgarantie").

With respect to any examples, hints or any typical values stated herein and/or any information regarding the application of the product, Infineon Technologies hereby disclaims any and all warranties and liabilities of any kind, including without limitation warranties of non-infringement of intellectual property rights of any third party.

In addition, any information given in this document is subject to customer's compliance with its obligations stated in this document and any applicable legal requirements, norms and standards concerning customer's products and any use of the product of Infineon Technologies in customer's applications.

The data contained in this document is exclusively intended for technically trained staff. It is the responsibility of customer's technical departments to evaluate the suitability of the product for the intended application and the completeness of the product information given in this document with respect to such application.

### Information

For further information on technology, delivery terms and conditions and prices please contact your nearest Infineon Technologies Office ([www.infineon.com](http://www.infineon.com)).

### Warnings

Due to technical requirements, components may contain dangerous substances. For information on the types in question, please contact the nearest Infineon Technologies Office.

The Infineon Technologies component described in this Data Sheet may be used in life-support devices or systems and/or automotive, aviation and aerospace applications or systems only with the express written approval of Infineon Technologies, if a failure of such components can reasonably be expected to cause the failure of that life-support, automotive, aviation and aerospace device or system or to affect the safety or effectiveness of that device or system. Life support devices or systems are intended to be implanted in the human body or to support and/or maintain and sustain and/or protect human life. If they fail, it is reasonable to assume that the health of the user or other persons may be endangered.