

CGHV96130F

130 W, 8.4 - 9.6 GHz, 50-ohm, Input/Output Matched GaN HEMT

Description

WolfSpeed's CGHV96130F is a gallium nitride (GaN) High Electron Mobility Transistor (HEMT) on Silicon Carbide (SiC) substrates. This GaN Internally Matched (IM) FET offers excellent power added efficiency in comparison to other technologies. GaN has superior properties compared to silicon or gallium arsenide, including higher breakdown voltage, higher saturated electron drift velocity and higher thermal conductivity. GaN HEMTs also offer greater power density and wider bandwidths compared to GaAs transistors. This IM FET is available in a metal/ceramic flanged package for optimal electrical and thermal performance.

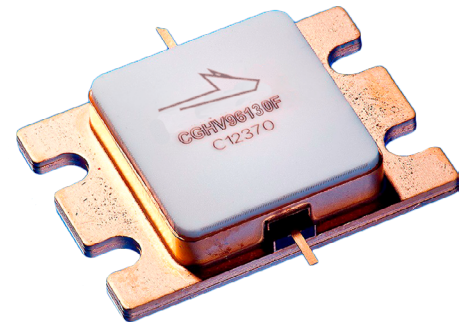

Package Type: 440217
PN: CGHV96130F

Typical Performance Over 8.4 - 9.6 GHz ($T_c = 25^\circ\text{C}$)

Parameter	8.4 GHz	8.6 GHz	8.8 GHz	9.0 GHz	9.2 GHz	9.4 GHz	9.6 GHz	Units
Linear Gain	13.6	13.1	13.3	13.5	13.8	13.0	11.8	dB
Output Power	184	173	173	168	163	165	153	W
Power Gain	8.7	8.4	8.4	8.3	8.0	8.2	7.8	dB
Power Added Efficiency	36	33	33	33	34	38	39	%

Note:

Measured in CGHV96130F-AMP (838179) under 100 μs pulse width, 10% duty, P_{IN} 44.0 dBm (25.1 W)

Features

- 8.4 - 9.6 GHz Operation
- 166 W P_{OUT} typical
- 7.5 dB Power Gain
- 42% Typical PAE
- 50 Ohm Internally Matched
- <0.3 dB Power Droop

Applications

- Marine Radar
- Weather Monitoring
- Air Traffic Control
- Maritime Vessel Traffic Control
- Port Security

 Large Signal Models Available for ADS and MWO





Absolute Maximum Ratings (not simultaneous)

Parameter	Symbol	Rating	Units	Conditions
Drain-source Voltage	V_{DSS}	120	V	25°C
Gate-Source Voltage	V_{GS}	-10, +2		
Power Dissipation	P_{DISS}	222.0	W	Pulse
Storage Temperature	T_{STG}	-65, +150	°C	
Operating Junction Temperature	T_J	225		
Maximum Drain Current ¹	I_{DMAX}	12	A	
Maximum Forward Gate Current	I_{GMAX}	28.8	mA	25°C
Soldering Temperature ²	T_S	245	°C	
Screw Torque	τ	40	in-oz	
Thermal Resistance, Junction to Case	$R_{\theta JC}$	0.73	°C/W	Pulse Width = 100 μ s, Duty Cycle = 10%, 85°C, $P_{DISS} = 173$ W
Case Operating Temperature ³	T_C	-40, +150	°C	

Notes:

¹ Current limit for long term, reliable operation

² Refer to the Application Note on soldering at wolfspeed.com/rf/document-library

³ See also, the Power Dissipation De-rating Curve on Page 9

Electrical Characteristics (Frequency = 9.4 GHz unless otherwise stated; $T_C = 25^\circ\text{C}$)

Characteristics	Symbol	Min.	Typ.	Max.	Units	Conditions
DC Characteristics¹						
Gate Threshold Voltage	$V_{GS(th)}$	-3.8	-3.0	-2.3	V	$V_{DS} = 10$ V, $I_D = 28.8$ mA
Gate Quiescent Voltage	$V_{GS(Q)}$	–	-2.7	–		$V_{DS} = 40$ V, $I_D = 1000$ mA
Saturated Drain Current ²	I_{DS}	21.0	26.0	–	A	$V_{DS} = 6.0$ V, $V_{GS} = 2.0$ V
Drain-Source Breakdown Voltage	V_{BD}	100	–	–	V_{DC}	$V_{GS} = -8$ V, $I_D = 28.8$ mA
RF Characteristics³						
Small Signal Gain	S21	10.5	12.2	–	dB	$V_{DD} = 40$ V, $I_{DQ} = 1000$ mA, $P_{IN} = -20$ dBm
Input Return Loss at 8.4 - 9.4 GHz	S11	–	-5.4	–		
Input Return Loss at 9.4 - 9.6 GHz		–	-5.6	–		
Output Return Loss	S22	–	-8.8	–		
Power Output ^{3,4}	P_{OUT}	130	166	–	W	$V_{DD} = 40$ V, $I_{DQ} = 1000$ mA, $P_{IN} = 44$ dBm
Power Added Efficiency ^{3,4}	PAE	30	42	–	%	
Power Gain ^{3,4}	P_G	7.0	7.5	–	dB	
Output Mismatch Stress	VSWR	–	–	5:1	Ψ	No damage at all phase angles, $V_{DD} = 40$ V, $I_{DQ} = 1000$ mA

Notes:

¹ Measured on wafer prior to packaging

² Scaled from PCM data

³ Measured in CGHV96100F2-TB (838179) under 100 μ s pulse width, 10% duty

⁴ Fixture loss de-embedded using the following offsets: Frequency = 9.4 GHz. Input = 0.5 dB and Output = 0.5 dB



CGHV96130F Typical Performance

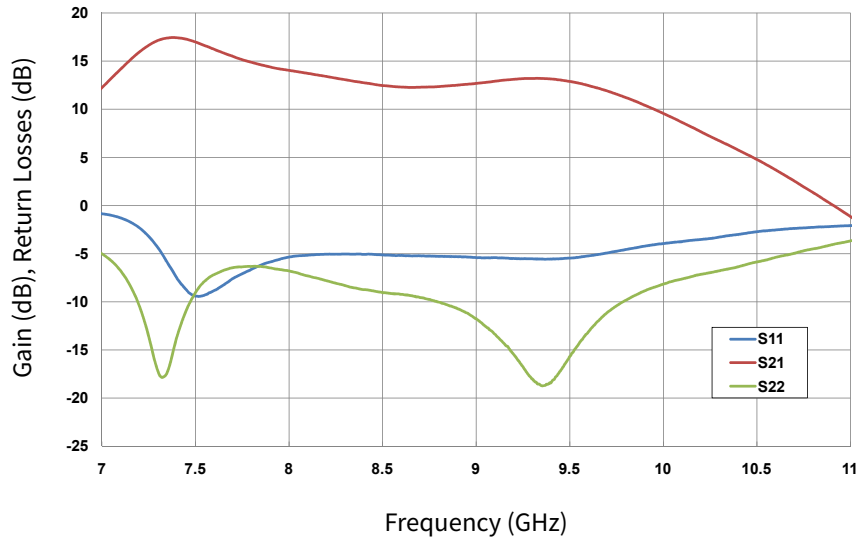

Figure 1. Small Signal Gain and Return Loss vs Frequency of CGHV96130F measured in CGHV96130F-AMP
 $V_{DS} = 40\text{ V}$, $I_{DQ} = 1000\text{ mA}$

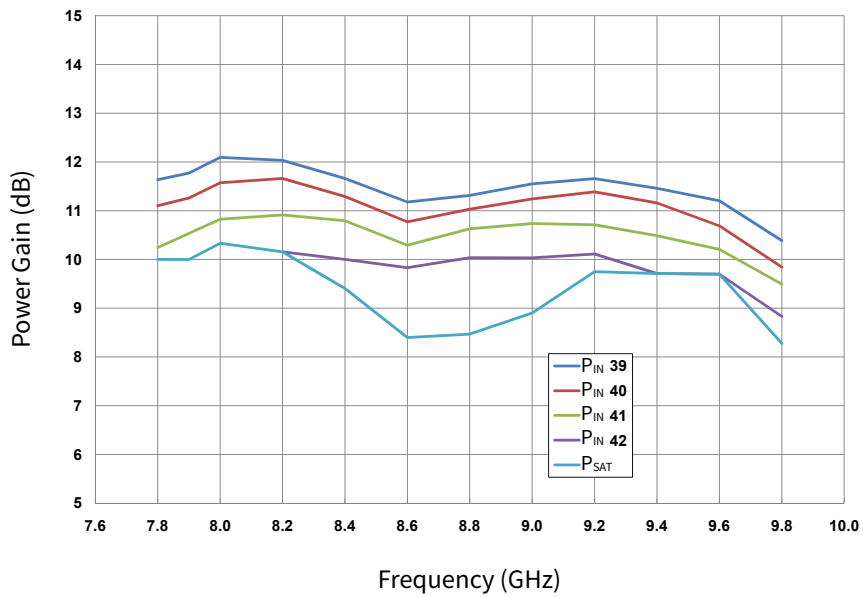

Figure 2. Power Gain vs. Frequency and Input Power
 $V_{DD} = 40\text{ V}$, Pulse Width = 100 μsec , Duty Cycle = 10%



CGHV96130F Typical Performance

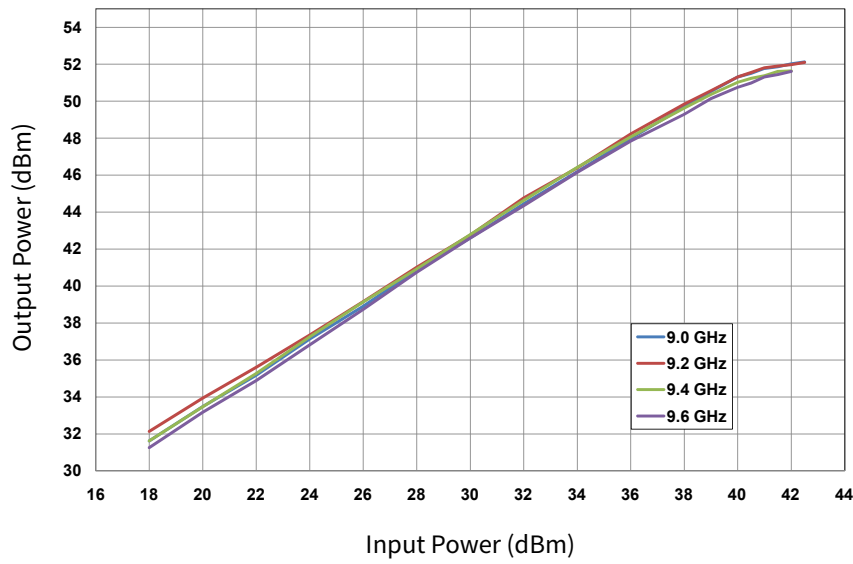

Figure 3. Output Power vs. Input Power
 $V_{DD} = 40\text{ V}$, Pulse Width = 100 μsec , Duty Cycle = 10%

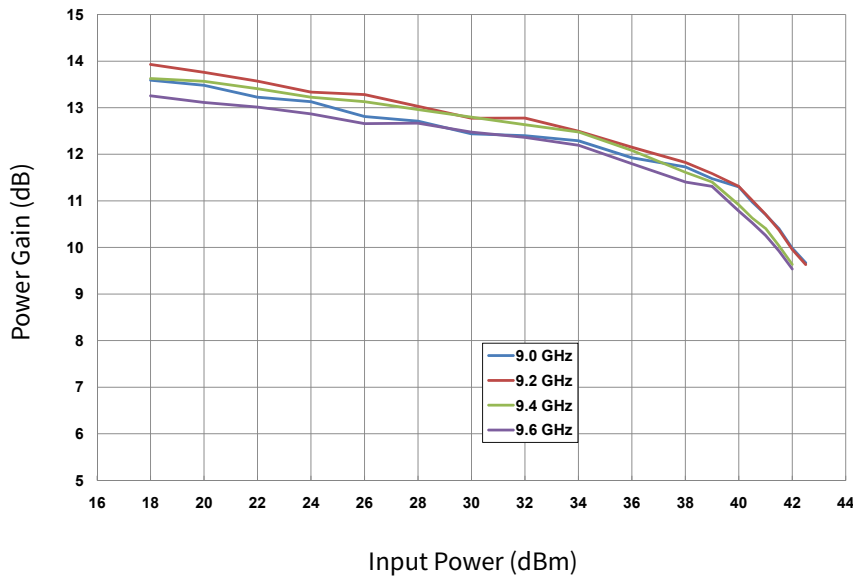

Figure 4. Power Gain vs. Frequency and Input Power
 $V_{DD} = 40\text{ V}$, Pulse Width = 100 μsec , Duty Cycle = 10%



CGHV96130F Typical Performance

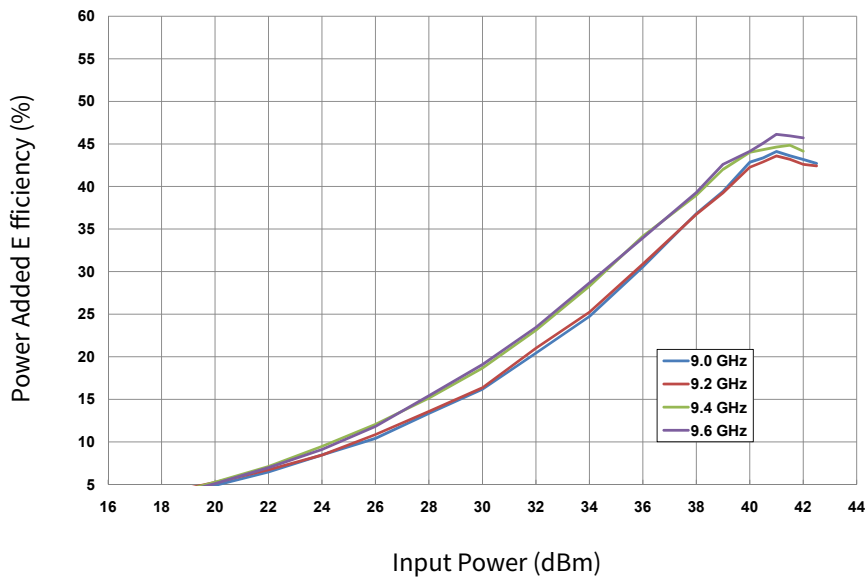

Figure 5. Power Added Efficiency vs. Input Power
 $V_{DD} = 40\text{ V}$, Pulse Width = 100 μsec , Duty Cycle = 10%

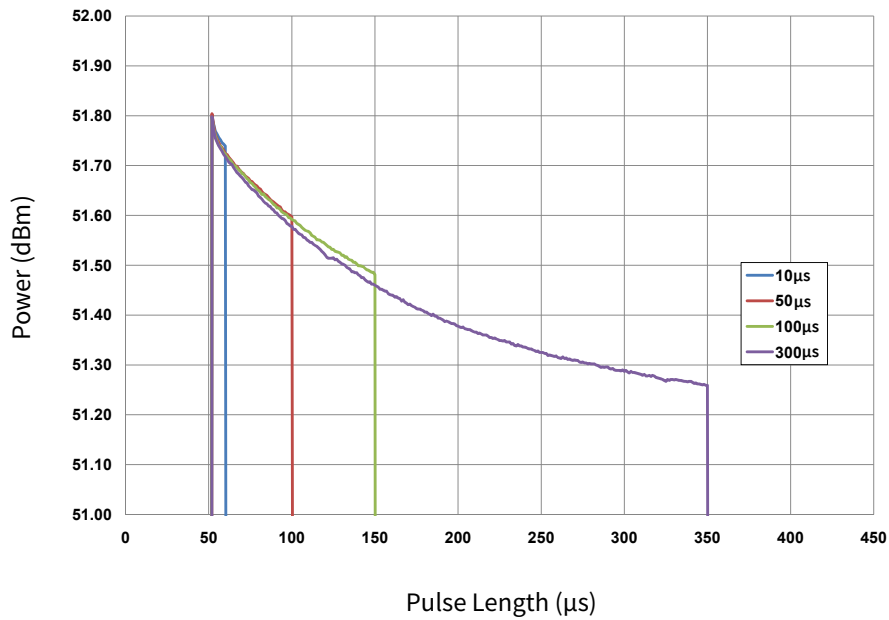

Figure 6. Output Power vs. Time
 $V_{DD} = 40\text{ V}$, $P_{IN} = 41\text{ dBm}$, Duty Cycle = 10%



CGHV96130F Typical Performance

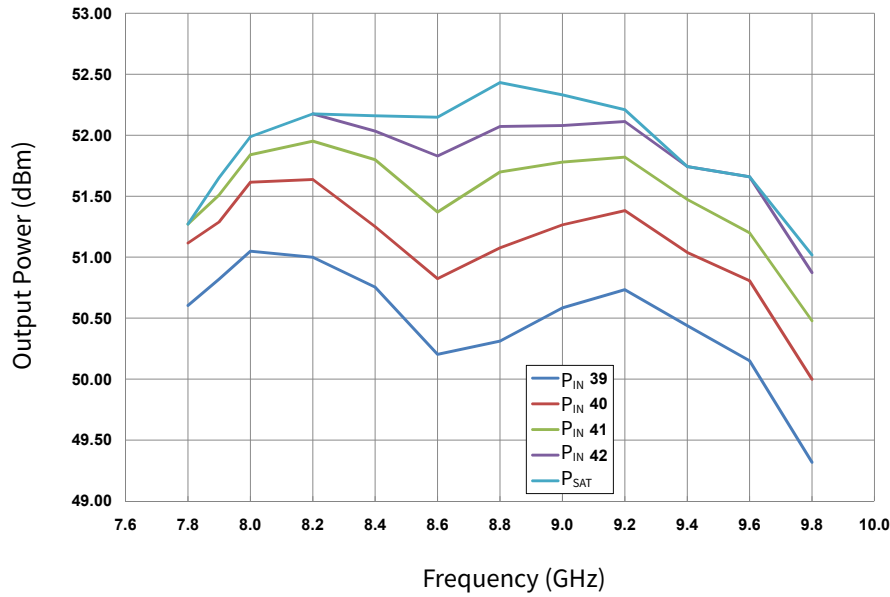

Figure 7. Output Power vs. Input Power & Frequency
 $V_{DD} = 40\text{ V}$, Pulse Width = 100 μsec , Duty Cycle = 10%

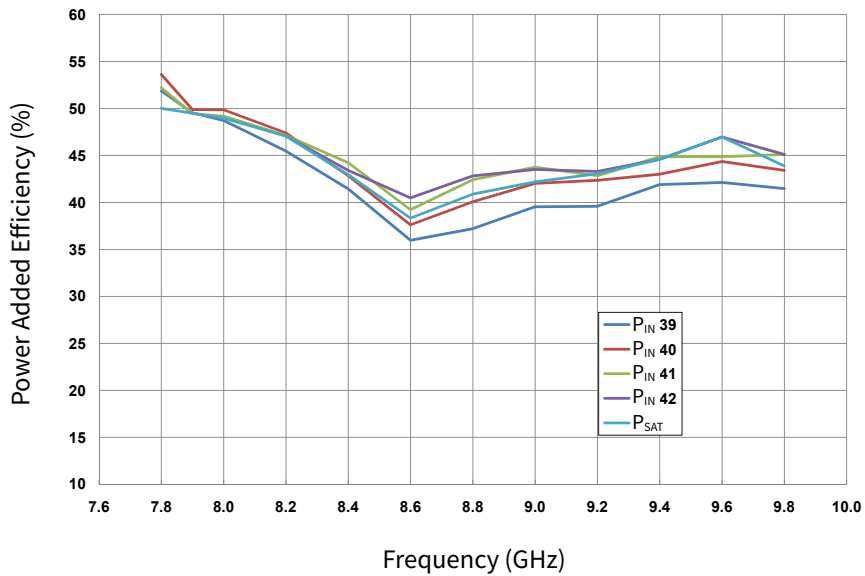

Figure 8. Power Added Efficiency vs. Input Power & Frequency
 $V_{DD} = 40\text{ V}$, Pulse Width = 100 μsec , Duty Cycle = 10%



CGHV96130F-AMP Demonstration Amplifier Circuit Bill of Materials

Designator	Description	Qty
R1	RES, 47 OHM +/-1%, 1/16 W, 0603, SMD	1
C1, C11	CAP, 1.6pF, +/- 0.1pF, 200V, 0402, ATC 600L	2
C2, C12	CAP, 1.0pF, +/- 0.1pF, 200V, 0402 ATC 600L	2
C3, C13	CAP, 10pF +/-5%, 0603, ATC	2
C4, C14	CAP, 470pF +/-5%, 100 V, 0603	2
C5, C15	CAP, 33,000pF, 0805, 100 V, X7R	2
C6	CAP, 10μF, 16 V, TANTALUM	1
C18	CAP, 470μF +/-20%, ELECTROLYTIC	1
J1,J2	CONNECTOR, SMA, PANEL MOUNT JACK, FLANGE, 4-HOLE, BLUNT POST, 20MIL	2
J3	CONNECTOR, HEADER, RT>PLZ .1CEN LK 9POS	1
J4	CONNECTOR, SMB, STRAIGHT JACK	1
	PCB, TEST FIXTURE, TACONICS RF35P, 20 MIL THK, 440210 PKG	1
	2-56 SOC HD SCREW 1/4 SS	4
	#2 SPLIT LOCKWASHER SS	4
Q1	CGHV96130F	1



CGHV96130F-AMP Demonstration Amplifier Circuit Schematic

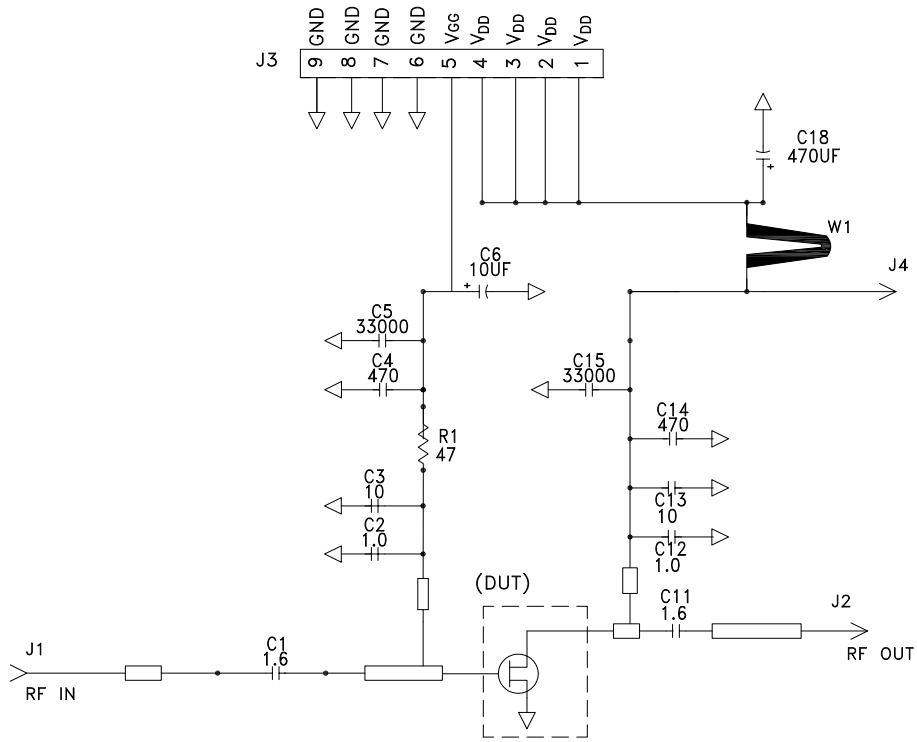

CGHV96130F-AMP Demonstration Amplifier Circuit Outline

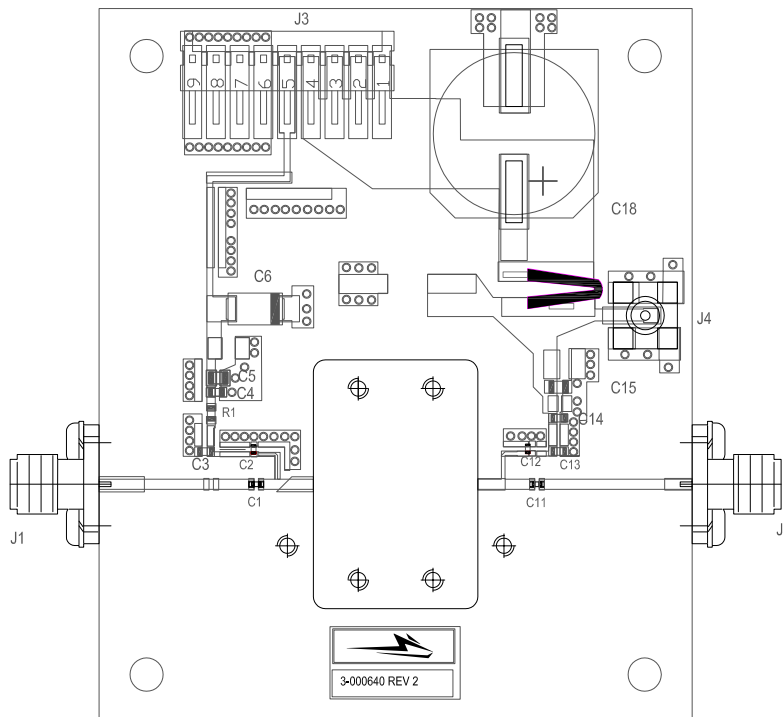



CGHV96130F Power Dissipation De-rating Curve

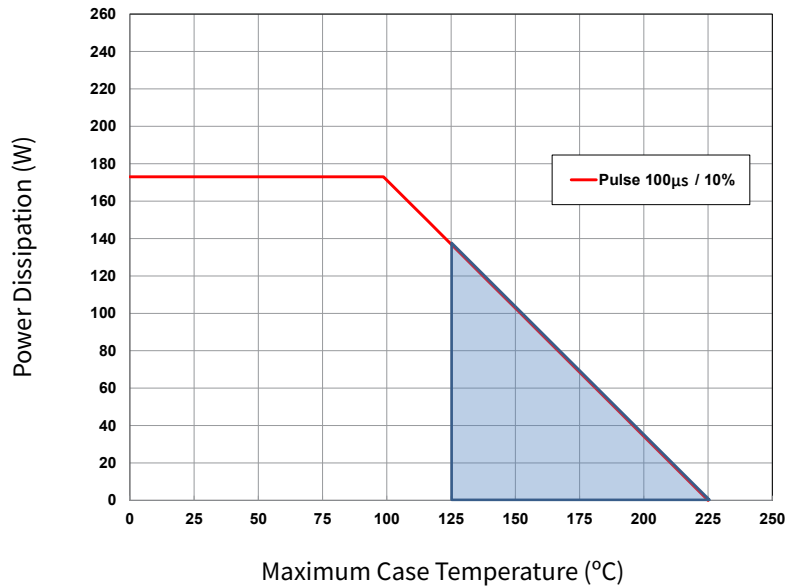

Note:
¹ Shaded area exceeds Maximum Case Operating Temperature (See Page 2)

CGHV96130F Transient Curve

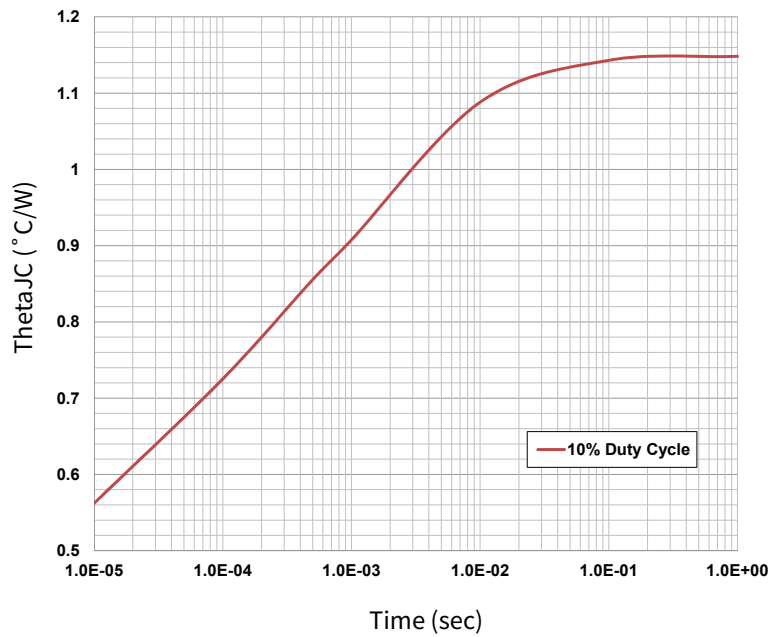

Electrostatic Discharge (ESD) Classifications

Parameter	Symbol	Class	Classification Level	Test Methodology
Human Body Model	HBM	TBD	ANSI/ESDA/JEDEC JS-001 Table 3	JEDEC JESD22 A114-D
Charge Device Model	CDM	TBD	ANSI/ESDA/JEDEC JS-002 Table 3	JEDEC JESD22 C101-C



Product Dimensions CGHV96130F (Package Type — 440217)

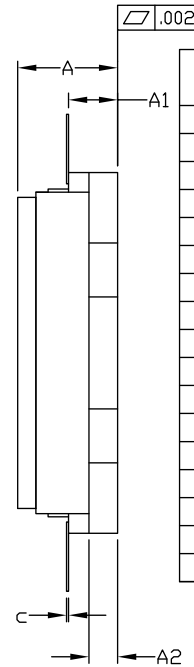
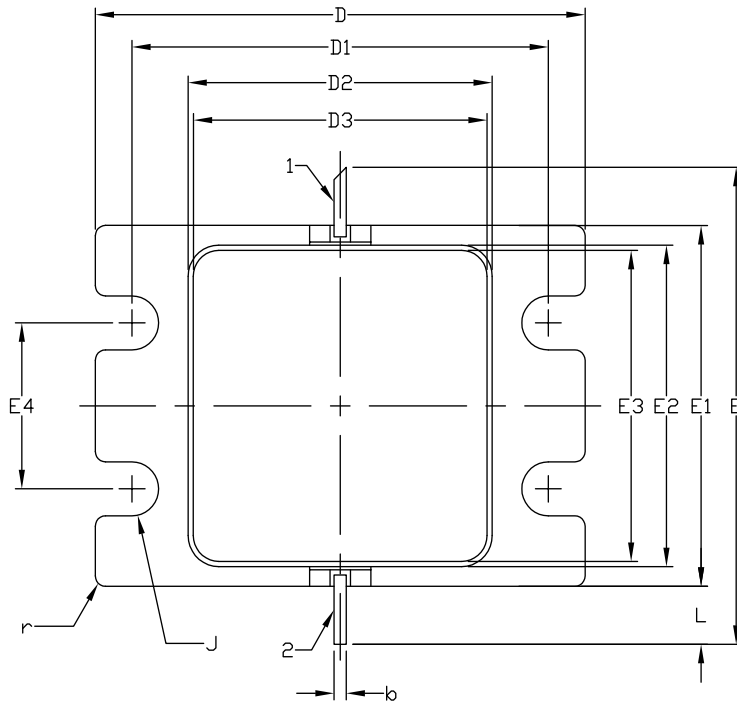

DIM	INCHES		MILLIMETERS		NOTES
	MIN	MAX	MIN	MAX	
A	0.188	0.198	4.78	5.03	
A1	0.088	0.100	2.24	2.54	2x
A2	0.049	0.061	1.24	1.55	
b	0.022	0.026	0.56	0.66	2x
c	0.002	0.006	0.05	0.15	
D	0.935	0.955	23.75	24.26	
D1	0.797	0.809	20.24	20.55	2x
D2	0.581	0.593	14.76	15.06	
D3	0.563	0.571	14.30	14.50	
E	0.906		23.01		REF
E1	0.679	0.691	17.25	17.55	
E2	0.604	0.616	15.34	15.65	
E3	0.586	0.594	14.88	15.09	
E4	0.309	0.321	7.85	8.15	2x
J	∅0.097	∅0.107	∅2.46	∅2.72	4x
L	0.090	0.130	2.29	3.30	2x
r	0.02 TYP		0.51 TYP		12x



Part Number System

CGHV96130F

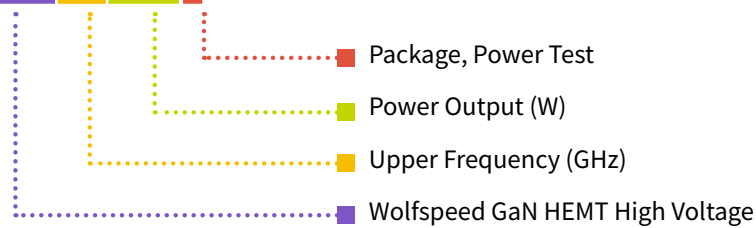

Table 1.

Parameter	Value	Units
Upper Frequency ¹	9.6	GHz
Power Output	130	W
Package	Flange	—

Note:

¹ Alpha characters used in frequency code indicate a value greater than 9.9 GHz. See Table 2 for value.

Table 2.

Character Code	Code Value
A	0
B	1
C	2
D	3
E	4
F	5
G	6
H	7
J	8
K	9
Examples	1A = 10.0 GHz 2H = 27.0 GHz

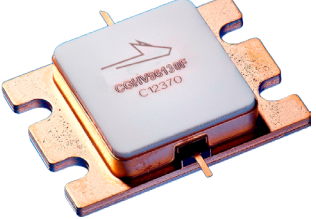
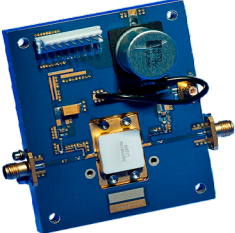

Product Ordering Information

Order Number	Description	Unit of Measure	Image
CGHV96130F	GaN HEMT	Each	 A square, silver-colored GaN HEMT device mounted on a copper-colored carrier. The device has a small logo and the text 'CGHV96130F C12370' printed on its top surface.
CGHV96130F-AMP	Test board with GaN HEMT	Each	 A blue printed circuit board (PCB) populated with various electronic components, including a central GaN HEMT device, a circular component, and several surface-mount components. It features SMA connectors and a multi-pin connector.

**For more information, please contact:**

4600 Silicon Drive
Durham, NC 27703 USA
Tel: +1.919.313.5300
www.wolfspeed.com/RF

Sales Contact
RFSales@wolfspeed.com

RF Product Marketing Contact
RFMarketing@wolfspeed.com

Notes & Disclaimer

Specifications are subject to change without notice. “Typical” parameters are the average values expected by Wolfspeed in large quantities and are provided for information purposes only. Wolfspeed products are not warranted or authorized for use as critical components in medical, life-saving, or life-sustaining applications, or other applications where a failure would reasonably be expected to cause severe personal injury or death. No responsibility is assumed by Wolfspeed for any infringement of patents or other rights of third parties which may result from use of the information contained herein. No license is granted by implication or otherwise under any patent or patent rights of Wolfspeed.

©2015-2022 Wolfspeed, Inc. All rights reserved. Wolfspeed® and the Wolfstreak logo are registered trademarks and the Wolfspeed logo is a trademark of Wolfspeed, Inc.
PATENT: <https://www.wolfspeed.com/legal/patents>

The information in this document is subject to change without notice.