

# SMT Power Inductors

Molded Power Inductor - PA4340.XXXNLT AND PM4340.XXXNLT Series



- Ⓟ **Height:** 3.0mm Max
- Ⓟ **Footprint:** 6.0mm x 5.4mm Max
- Ⓟ **Current Rating:** up to 23A
- Ⓟ **Inductance Range:** 0.10uH to 33uH
- Ⓟ Shielded construction and compact design
- Ⓟ High current, low DCR, and high efficiency
- Ⓟ Minimized acoustic noise and minimized leakage flux
- Ⓟ 200Vdc Isolation between terminal and core

Electrical Specifications @ 25°C - Operating Temperature -55°C to +125°C

Commercial <sup>6,7</sup>	Automotive <sup>6,7</sup>	Inductance <sup>5</sup> 100KHz, 1V uH±20%	Rated <sup>3</sup> Current A	DC Resistance		Saturation <sup>2</sup> Current A
				TYP. mΩ	MAX. mΩ	
PA4340.101NLT	PM4340.101NLT	0.10*	23	2.5	3.0	27
PA4340.151NLT	PM4340.151NLT	0.15*	18	2.3	2.7	30
PA4340.201NLT	PM4340.201NLT	0.20*	16	2.6	3.2	25
PA4340.221NLT	PM4340.221NLT	0.22*	15.5	3.7	4.4	21
PA4340.331NLT	PM4340.331NLT	0.33	14	4.3	5.0	18
PA4340.471NLT	PM4340.471NLT	0.47	12	6.4	7.4	16
PA4340.561NLT	PM4340.561NLT	0.56	10	8.0	10	15
PA4340.681NLT	PM4340.681NLT	0.68	8.5	10	12	14
PA4340.821NLT	PM4340.821NLT	0.82	8.0	11.5	13	12.5
PA4340.102NLT	PM4340.102NLT	1.0	7.0	13	14	11
PA4340.122NLT	PM4340.122NLT	1.2	6.5	14	16	11
PA4340.152NLT	PM4340.152NLT	1.5	6.0	16	25	10
PA4340.222NLT	PM4340.222NLT	2.2	5.5	25	35	9.0
PA4340.332NLT	PM4340.332NLT	3.3	5.0	32	38	8.0
PA4340.362NLT	PA4340.362NLT	3.6	4.9	46	54	7.0
PA4340.472NLT	PM4340.472NLT	4.7	4.6	50	53	6.0
PA4340.562NLT	PM4340.562NLT	5.6	4.25	55	63	4.5
PA4340.682NLT	PM4340.682NLT	6.8	4.0	68	76.2	4.3
PA4340.103NLT	PM4340.103NLT	10	2.75	110	128	3.5
PA4340.153NLT	PM4340.153NLT	15	2.1	165	190	2.6
PA4340.183NLT	PM4340.183NLT	18	2.0	195	230	2.3
PA4340.223NLT	PM4340.223NLT	22	1.9	220	250	1.7
PA4340.333NLT	PM4340.333NLT	33	1.6	380	440	1.6

# SMT Power Inductors

Molded Power Inductor - PA4340.XXXNLT AND PM4340.XXXNLT Series



## Notes:

1. Actual temperature of the component during system operation (ambient plus temperature rise) must be within the standard operating range.
2. The saturation current is the current at which the initial inductance drops approximately 30% at the stated ambient temperature. This current is determined by placing the component in the specified ambient environment and applying a short duration pulse current (to eliminate self-heating effect) to the component.
3. The rated current is the DC current required to raise the component temperature by approximately 40 °C. Take note that the components' performance varies depending on the system condition. It is suggested that the component be tested at the system level, to verify the temperature rise of the component during system operation.
4. The part temperature (ambient+temp rise) should not exceed 125 °C under worst case operating conditions. Circuit design, PCB trace size and thickness, airflow and other cooling provisions all affect the part temperature. Part temperature should be verified in the end application.
5. Please note that the inductance tolerance of all parts are +/-20% except those indicated with a \* which are +/-30%.
6. Parts shown in bold are standard catalog parts and are available through sample stock and distribution. Parts in lighter font are available but are not necessarily held in sample stock or distribution **and lead times may be longer**. Please contact Pulse for availability.
7. Both the PA and PM part numbers are AEC-Q200 qualified parts. The PM part numbers have full automotive IATF16949 certification. The PM part number dimensions are 100% tested in production but do not necessarily meet a product capability index (Cpk)> 1.33 and therefore may not strictly conform to PPAP.
8. Special characteristics

## Mechanical

### PA4340/ PM4340

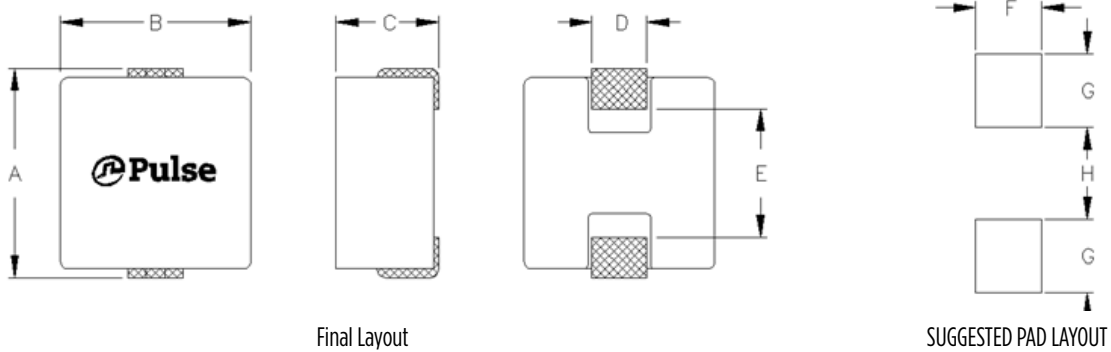

Series	A	B	C	D	E	F	G	H
PA4340/PM4340	6.0 MAX	5.4 MAX	3.0 MAX	(1.5)	3.5 MAX	(1.8)	(2.0)	(2.5)

All Dimensions in mm.

### TAPE & REEL INFO

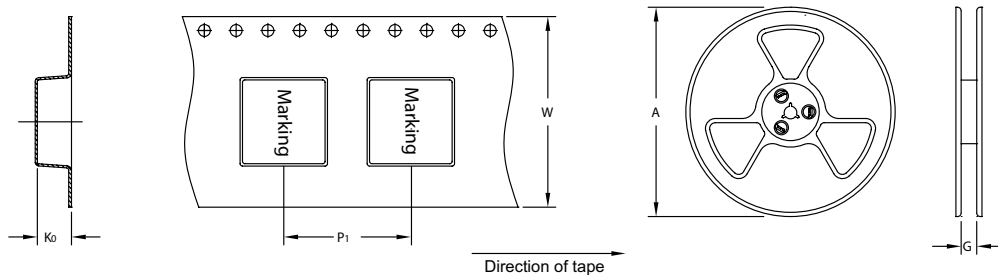

### SURFACE MOUNTING TYPE, REEL/TAPE LIST

	REEL SIZE (mm)		TAPE SIZE (mm)			QTY
	A	G	P <sub>1</sub>	W	K <sub>0</sub>	PCS/REEL
PA4340/PM4340	Ø330	12	8	12	3.3	2000

## Typical Performance Curves

### PA4340.XXXNLT

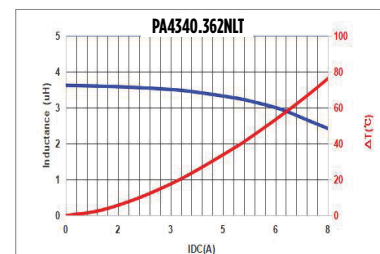
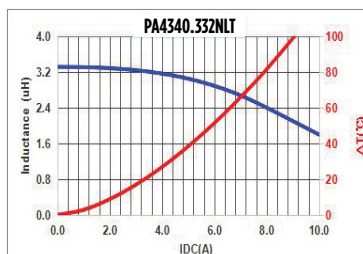
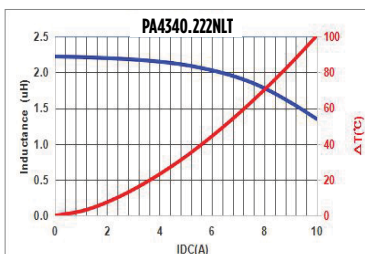
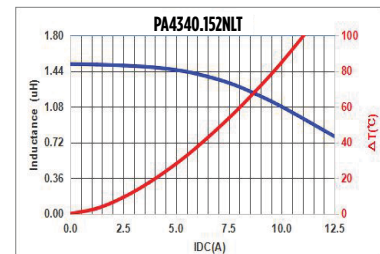
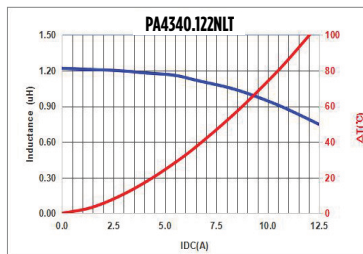
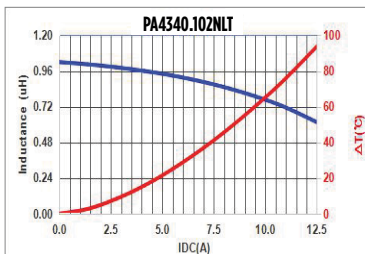
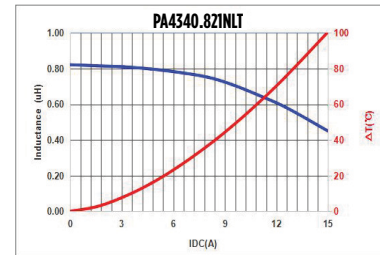
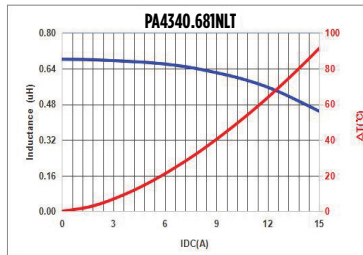
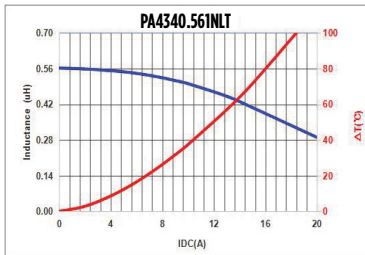
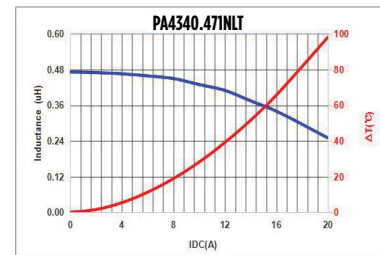
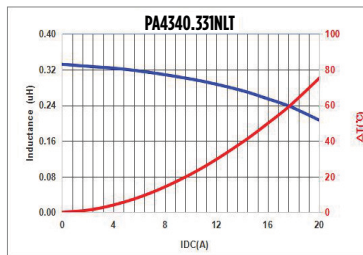
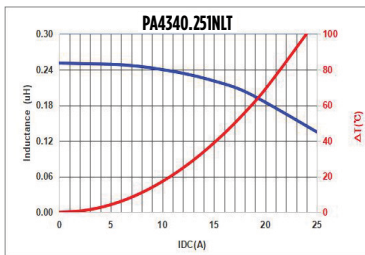
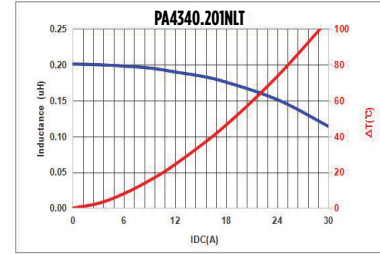
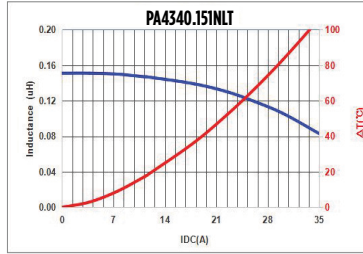
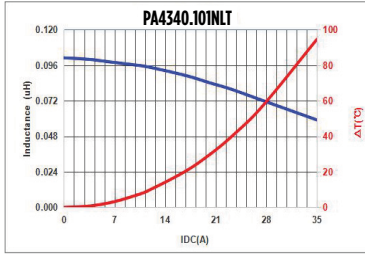

# SMT Power Inductors

Molded Power Inductor - PA4340.XXXNLT AND PM4340.XXXNLT Series

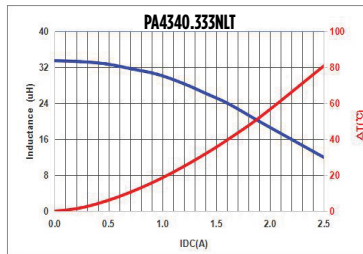
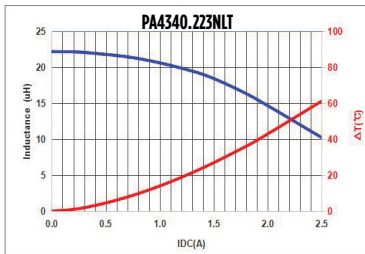
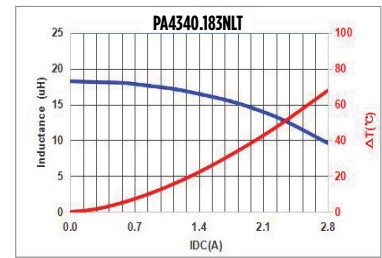
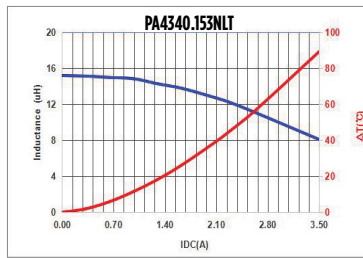
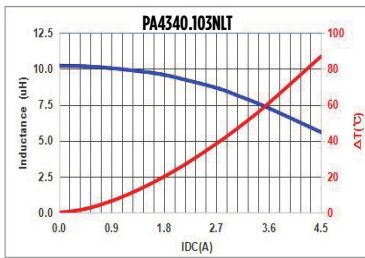
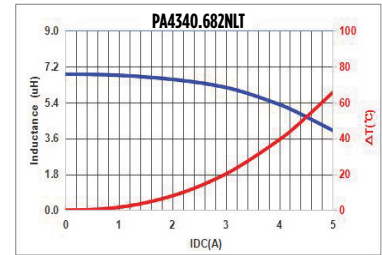
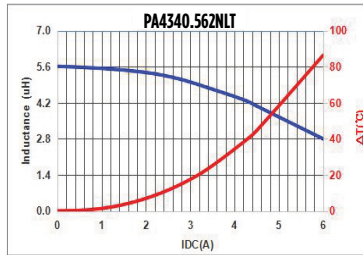
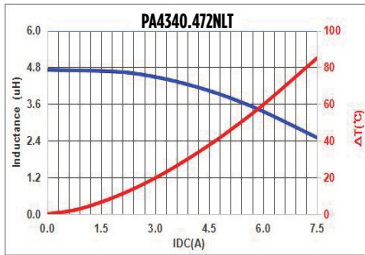

## For More Information:

Americas - [proinfo\\_power@pulseelectronics.com](mailto:proinfo_power@pulseelectronics.com) | Europe - [power-apps-europe@pulseelectronics.com](mailto:power-apps-europe@pulseelectronics.com) | Asia - [power-apps-asia@pulseelectronics.com](mailto:power-apps-asia@pulseelectronics.com)

Performance warranty of products offered on this data sheet is limited to the parameters specified. Data is subject to change without notice. Other brand and product names mentioned herein may be trademarks or registered trademarks of their respective owners. © Copyright, 2020. Pulse Electronics, Inc. All rights reserved.

# Mouser Electronics

Authorized Distributor

Click to View Pricing, Inventory, Delivery & Lifecycle Information:

## Pulse:

[PA4340.681NLT](#) [PA4340.153NLT](#) [PA4340.223NLT](#) [PA4340.101NLT](#) [PA4340.472NLT](#) [PA4340.332NLT](#)  
[PA4340.682NLT](#) [PA4340.222NLT](#) [PA4340.331NLT](#) [PA4340.471NLT](#) [PA4340.152NLT](#) [PA4340.221NLT](#)  
[PA4340.102NLT](#) [PA4340.333NLT](#) [PA4340.201NLT](#) [PA4340.183NLT](#) [PA4340.103NLT](#) [PA4340.122NLT](#)  
[PA4340.562NLT](#)