

SRDA05 Series 8pF 30A Diode Array

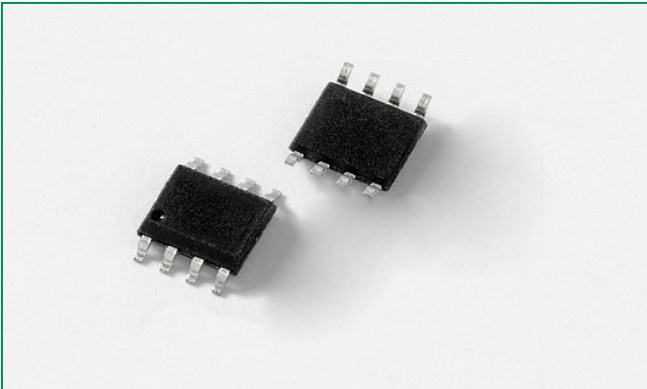

Description

The SRDA05 integrates low capacitance rail-to-rail diodes with an additional zener diode to protect I/O pins against ESD and lightning induced surge events. This robust device can safely absorb up to 30A per IEC61000-4-5 ($t_p=8/20\mu s$) without performance degradation and a minimum $\pm 30kV$ ESD per IEC61000-4-2 international standard. Its low loading capacitance makes it ideal for high-speed interface protection.

Pinout

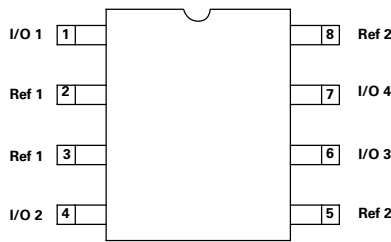

SOIC-8 (Top View)

Note: Pinout diagrams above shown as device footprint on circuit board.

Features

- Lightning protection, IEC61000-4-5, 30A (8/20 μs)
- EFT, IEC61000-4-4, 50A (5/50ns)
- ESD, IEC61000-4-2, $\pm 30kV$ contact, $\pm 30kV$ air
- Low clamping voltage
- Low leakage current
- SOIC-8 surface mount package (JEDEC MS-012)

Functional Block Diagram

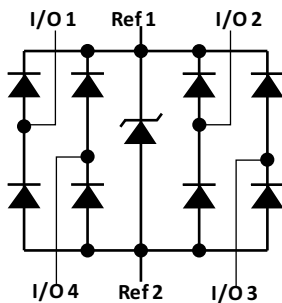

Applications

- Tertiary (IC Side) Protection:
 - T1/E1/T3/E3
 - HDSD/SDSL
 - Ethernet
- RS232, RS485
- Video Line Protection
- Security Cameras
- Storage DVRs
- Network Equipment
- Instrumentation, Medical Equipment

Additional Information



Datasheet



Resources



Samples

Life Support Note:

Not Intended for Use in Life Support or Life Saving Applications

The products shown herein are not designed for use in life sustaining or life saving applications unless otherwise expressly indicated.

Application Example

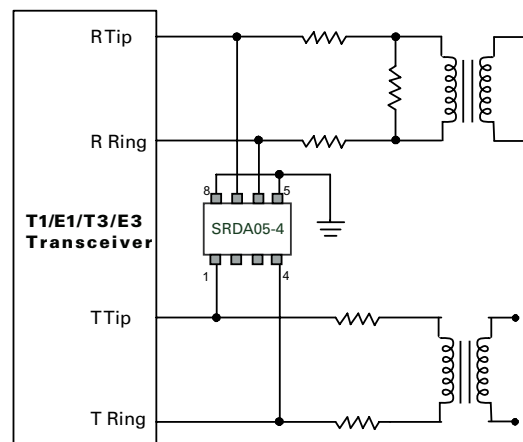

T1/E1/T3/E3 Interface Protection

Absolute Maximum Ratings

Symbol	Parameter	Value	Units
P_{pk}	Peak Pulse Power (8/20 μ s)	600	W
I_{pp}	Peak Pulse Current (8/20 μ s)	30	A
T_{op}	Operating Temperature	-40 to 125	°C
T_{stor}	Storage Temperature	-55 to 150	°C

CAUTION: Stresses above those listed in "Absolute Maximum Ratings" may cause permanent damage to the device. This is a stress only rating and operation of the device at these or any other conditions above those indicated in the operational sections of this specification is not implied.

Thermal Information

Parameter	Rating	Units
SOIC Package	170	°C/W
Operating Temperature Range	-40 to 125	°C
Storage Temperature Range	-55 to 150	°C
Maximum Junction Temperature	150	°C
Maximum Lead Temperature (Soldering 20-40s) (SOIC - Lead Tips Only)	260	°C

Electrical Characteristics ($T_{op} = 25^{\circ}\text{C}$)

Parameter	Symbol	Test Conditions	Min	Typ	Max	Units
Reverse Stand-Off Voltage	V_{RWM}	$I_T \leq 1\mu\text{A}$	-	-	5.0	V
Reverse Leakage Current	I_R	$V_R = 5\text{V}$	-	-	10	μA
Reverse Breakdown Voltage	V_{BR}	$I_T = 1\text{mA}$	6	-	-	V
Clamping Voltage, Line-Ground ¹	V_C	$I_{pp} = 1\text{A}, t_p = 8/20\mu\text{s}$	-	9.2	-	V
Clamping Voltage, Line-Ground ¹	V_C	$I_{pp} = 2\text{A}, t_p = 8/20\mu\text{s}$	-	10.0	-	V
Clamping Voltage, Line-Ground ¹	V_C	$I_{pp} = 10\text{A}, t_p = 8/20\mu\text{s}$	-	14.5	-	V
Clamping Voltage, Line-Ground ¹	V_C	$I_{pp} = 25\text{A}, t_p = 8/20\mu\text{s}$	-	21.0	-	V
Dynamic Resistance, Line-Ground ¹	R_{DYN}	$(V_{C2} - V_{C1}) / (I_{PP2} - I_{PP1})$	-	0.8	-	Ω
ESD Withstand Voltage ¹	V_{ESD}	IEC61000-4-2 (Contact Discharge)	± 30	-	-	kV
		IEC61000-4-2 (Air Discharge)	± 30	-	-	kV
Diode Capacitance ¹	$C_{I/O-I/O}$	Reverse Bias=0V	-	4.0	-	pF
	$C_{I/O-GND}$	Reverse Bias=0V	-	8.0	-	pF

¹ Parameter is guaranteed by design and/or device characterization.

Normalized Capacitance vs. Bias Voltage

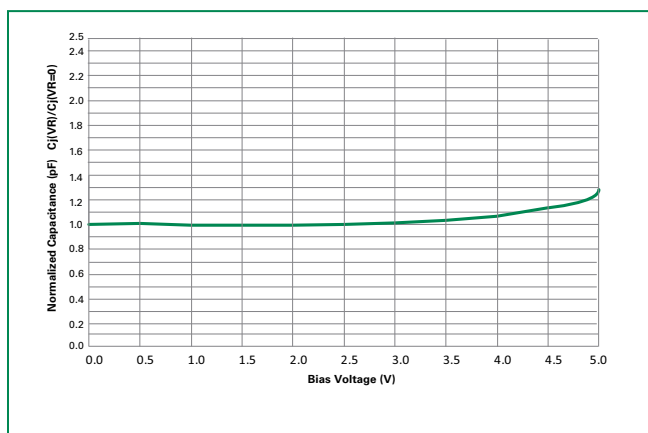

Non-Repetitive Peak Pulse Power vs. Pulse Time

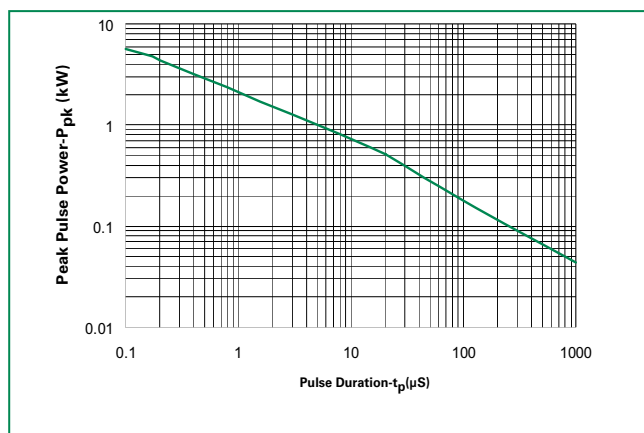

Clamping Voltage vs. I_{pp}

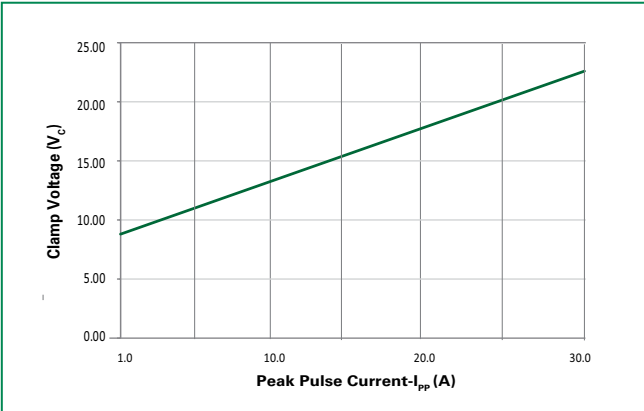

Power Derating Curve

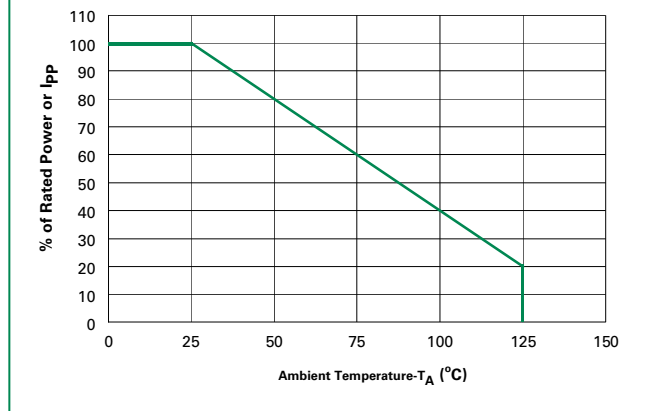

Pulse Waveform

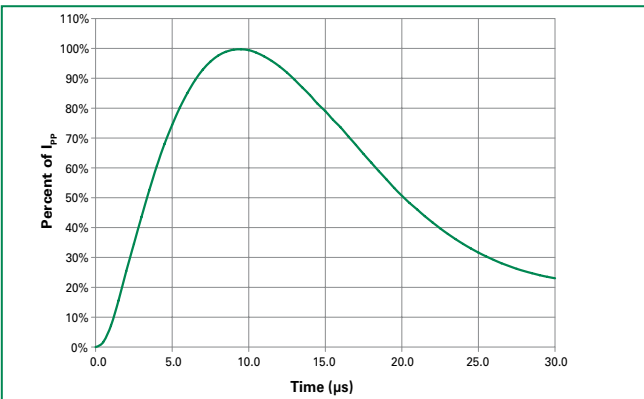

Product Characteristics

Lead Plating	Matte Tin
Lead Material	Copper Alloy
Lead Coplanarity	0.0004 inches (0.102mm)
Substitute Material	Silicon
Body Material	Molded Epoxy
Flammability	UL 94 V-0

Notes :

1. All dimensions are in millimeters
2. Dimensions include solder plating.
3. Dimensions are exclusive of mold flash & metal burr.
4. Blo is facing up for mold and facing down for trim/form, i.e. reverse trim/form.
5. Package surface matte finish VDI 11-13.

Soldering Parameters

Reflow Condition		Pb – Free assembly
Pre Heat	- Temperature Min ($T_{s(min)}$)	150°C
	- Temperature Max ($T_{s(max)}$)	200°C
	- Time (min to max) (t_s)	60 – 180 secs
Average ramp up rate (Liquidus) Temp (T_L) to peak		3°C/second max
$T_{s(max)}$ to T_L - Ramp-up Rate		3°C/second max
Reflow	- Temperature (T_L) (Liquidus)	217°C
	- Temperature (t_l)	60 – 150 seconds
Peak Temperature (T_p)		260 ^{+0/-5} °C
Time within 5°C of actual peak Temperature (t_p)		20 – 40 seconds
Ramp-down Rate		6°C/second max
Time 25°C to peak Temperature (T_p)		8 minutes Max.
Do not exceed		260°C

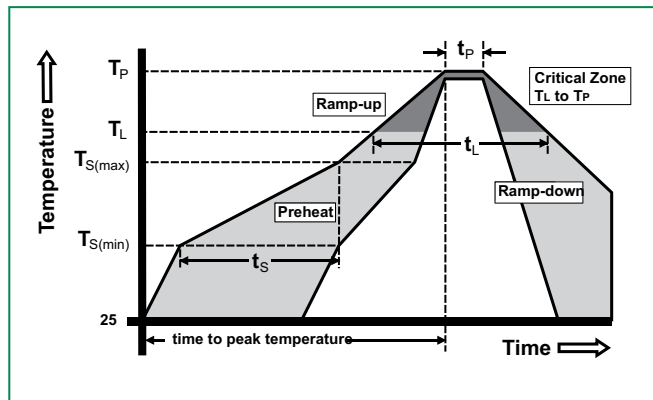

Ordering Information

Part Number	Package	Marking	Min. Order Qty.
SRDA05-4BTG	SOIC-8	LF SRDA05 SYYWW	2500

Part Numbering System

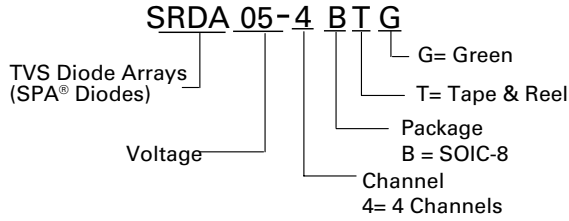

Part Marking System

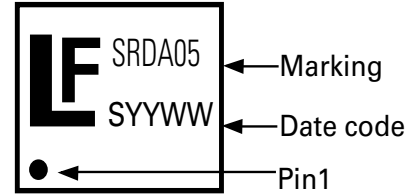

Package Dimensions – Mechanical Drawings and Recommended Solder Pad Outline

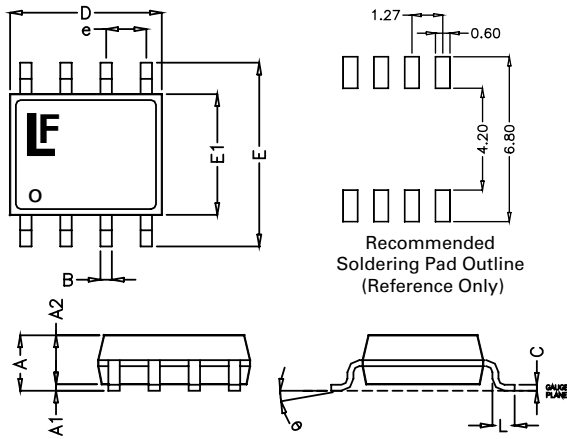

Package	SOIC			
Pins	8			
JEDEC	MS-012			
	Millimetres		Inches	
	Min	Max	Min	Max
A	1.35	1.75	0.053	0.069
A1	0.10	0.25	0.004	0.010
A2	1.25	1.65	0.050	0.065
B	0.31	0.51	0.012	0.020
c	0.17	0.25	0.007	0.010
D	4.70	5.10	0.185	0.201
E	5.80	6.20	0.228	0.244
E1	3.80	4.00	0.150	0.157
e	1.27 BSC		0.050 BSC	
L	0.40	1.27	0.016	0.050

Embossed Carrier Tape & Reel Specification – SOIC Package

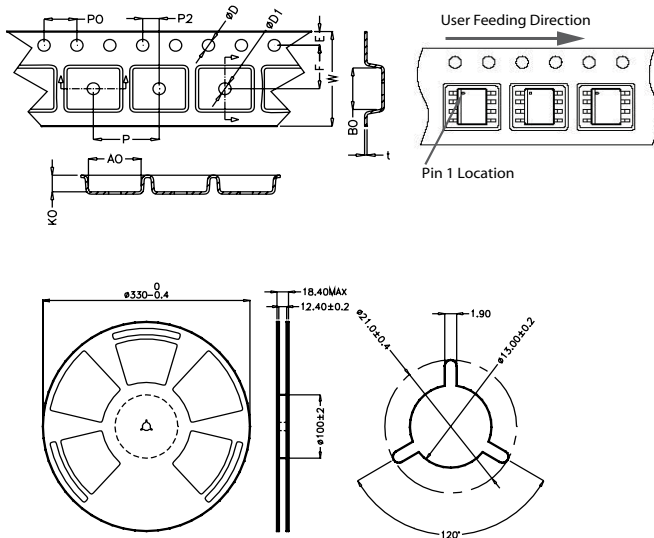

	Millimetres		Inches	
	Min	Max	Min	Max
E	1.65	1.85	0.065	0.073
F	5.4	5.6	0.213	0.22
P2	1.95	2.05	0.077	0.081
D	1.5	1.6	0.059	0.063
D1	1.50 Min		0.059 Min	
P0	3.9	4.1	0.154	0.161
10P0	40.0 ± 0.20		1.574 ± 0.008	
W	11.9	12.1	0.468	0.476
P	7.9	8.1	0.311	0.319
A0	6.3	6.5	0.248	0.256
B0	5.1	5.3	0.2	0.209
K0	2	2.2	0.079	0.087
t	0.30 ± 0.05		0.012 ± 0.002	

Disclaimer Notice - Information furnished is believed to be accurate and reliable. However, users should independently evaluate the suitability of and test each product selected for their own applications. Littelfuse products are not designed for, and may not be used in, all applications. Read complete Disclaimer Notice at www.littelfuse.com/disclaimer-electronics.