

TSOP (Type II, Open Top)

IC235 Series

Characteristics

Insulation Resistance: 1,000M Ω minimum at 500 VDC
 Withstanding Voltage: 700 VAC for 1 Minute
 Contact Resistance: 30m Ω max. at 10mA/20mV (Initial)
 Operating Temperature: -40°C ~ +150°C

Material

Insulator: PEI (Glass Filled)
 Contact: Beryllium Copper
 Plating: Gold over Nickel

IC235- 032 2- 001 N

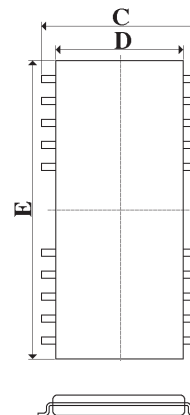
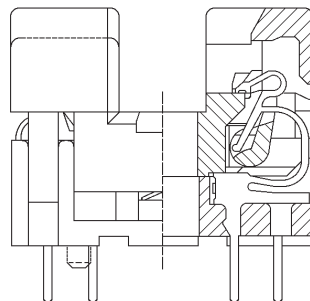
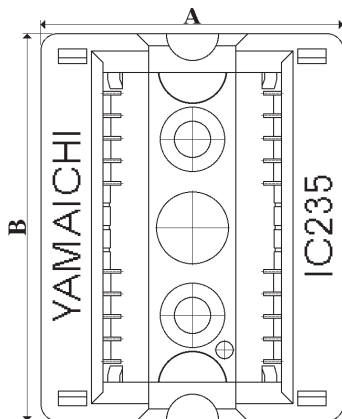
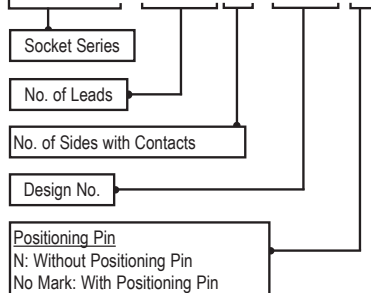

Small Outline Packages

Part Number	No. of Leads	Pitch	Dimensions				
			A	B	C	D	E
IC235-0202-201-*	20 (26)	1.27	17.3	22.0	9.22	7.56	17.44
IC235-0242-202-*	24 (26)	1.27	17.3	22.0	9.22	7.56	17.44
IC235-0242-203-*	24 (28)	1.27	19.9	23.3	11.76	10.16	18.71
IC235-0262-206-*	26	1.27	17.3	22.0	9.22	7.56	17.44
IC235-0282-204-*	28	1.27	19.9	23.3	11.76	10.16	18.71
IC235-0322-253*	32	1.27	20.2	26.4	11.76	10.16	21.35
IC235-0402-205-*	40 (44)	0.80	19.9	24.0	11.76	10.16	18.71
IC235-0442-207-*	44	0.80	19.9	24.0	11.76	10.16	18.71
IC235-0442-215-*	-50	0.80	20.2	26.4	11.76	10.16	21.35
IC235-0502-209-*	50	0.80	20.2	26.4	11.76	10.16	21.35
IC235-0542-218-*	54	0.80	23.0	28.0	14.30	12.70	22.47
IC235-0542-239	54	0.80	20.2	28.0	11.76	10.16	22.92

Note: Please call Yamaichi Electronics for other available pin counts.

TSOP (Type II, Open Top)

PC BOARD LAYOUTS

IC235 Series

TSOP IC235-0202-201 (20 Pins)

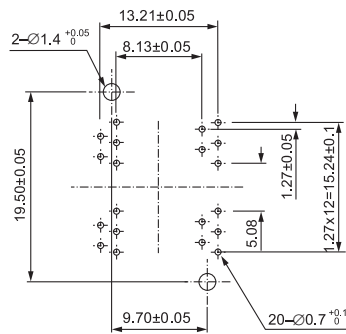

TSOP IC235-0262-206 (26 Pins)

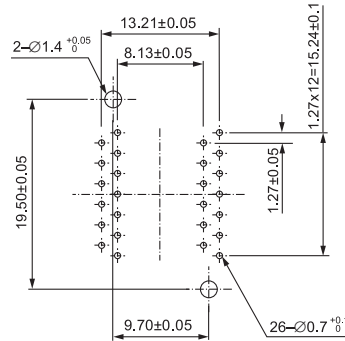

TSOP IC235-0242-202 (24 Pins)

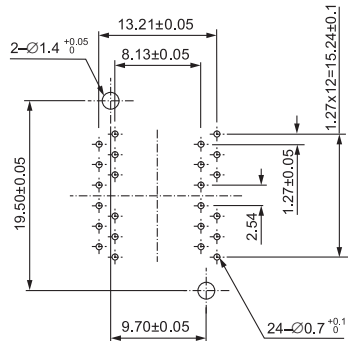

TSOP IC235-0282-204 (28 Pins)

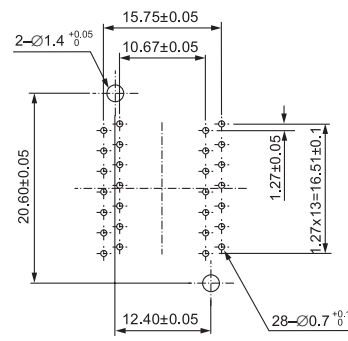

TSOP IC235-0242-203 (24 Pins)

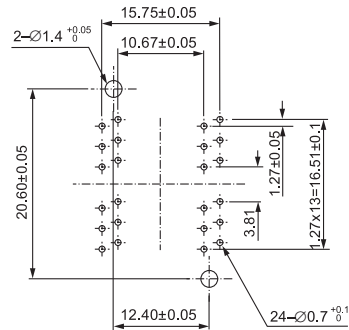

TSOP IC235-0402-205 (40 Pins)

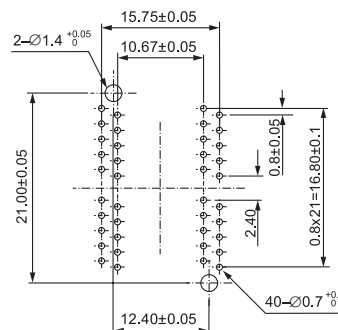

PC BOARD LAYOUTS

TSOP (Type II, Open Top)

IC235 Series

TSOP IC235-0442-207 (44 Pins)

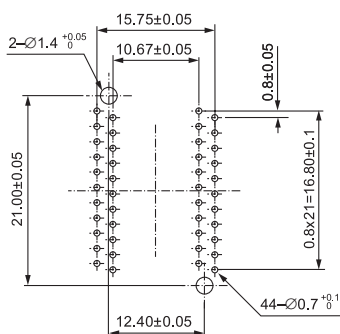

TSOP IC235-0502-209 (50 Pins)

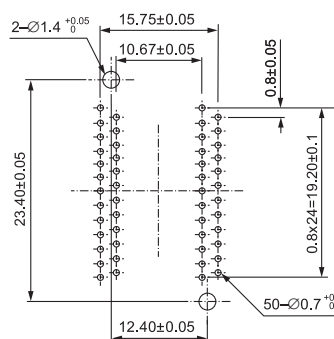

TSOP IC235-0442-215 (44 Pins)

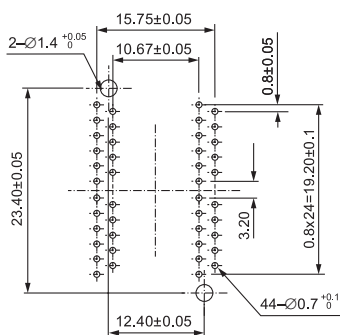

TSOP IC235-0542-218 (54 Pins)
TSOP IC235-0542-218-2 (54 Pins)

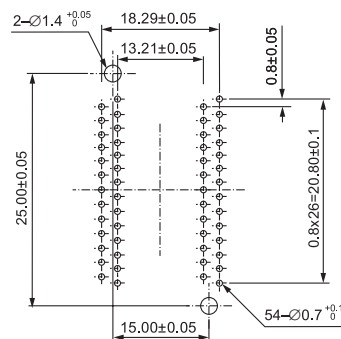

Small Outline Packages

Mouser Electronics

Authorized Distributor

Click to View Pricing, Inventory, Delivery & Lifecycle Information:

[Yamaichi Electronics:](#)

[IC235-0442-207-N](#)