

## Type 3503 Series

### Key Features

High thermal conductivity Aluminum-Nitride substrate.

High Power / Size ratio – 2W in 1206 size.

Thin film power resistors with TCR  $\pm 50\text{ppm}/^{\circ}\text{C}$  and tolerance  $\pm 1\%$ .



TE are pleased to introduce the new 3503 series. This is a high stability Thin Film Chip Power resistor range offering very high power / size ratio – 2W in 1206 size. The 3503 series offers TCR at  $\pm 50\text{ppm}/^{\circ}\text{C}$  and resistance tolerance at  $\pm 1\%$  as standard. Resistance values are within the IEC 63 E96 and E24 value grids. The 3503 resistors have accurate and uniform physical dimensions to facilitate automatic placement methods.

### Applications

#### Power Supplies

#### Power Switching

#### Braking Systems

#### Automation Controls

### Characteristics – Electrical

Power Rating @ 70°C	2.0W
Resistance Range	50Ω ~ 30.1KΩ
Temperature Coefficient of resistance	$\pm 50\text{PPM}/^{\circ}\text{C}$
Max. Operating Voltage	100V
Max Overload Voltage	200V
Operating Temperature Range	-55°C ~ 155°C

Notes:

Power rating dependant upon mounting by user

Operating Voltage=  $\sqrt{P \cdot R}$  or Max. Operating voltage listed above, whichever is lower

### Derating Curve

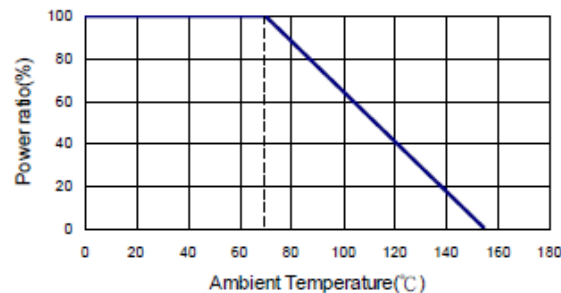

## Environmental Characteristics

Item	Requirement	Test Method
Temperature Coefficient of Resistance (TCR)	As per TCRs specified in Electrical Characteristics tables	MIL-STD-202 Method 304 +25/-55/+25/+125/+25°C
Short Time Overload	$\Delta R \pm 0.5\%$	Actual power handling capability is limited by the end user mounting process. As with any high power chip resistor the ability to remove the heat is critical to the overall performance of the device.
Insulation Resistance	>9999 M $\Omega$	MIL-STD-202 Method 302 Apply 100VDC for 1 minute
Endurance	$\Delta R \pm 1\%$	MIL-STD-202 Method 108 70 $\pm$ 2°C, RCWV for 1000 hrs with 1.5 hrs "ON" and 0.5 hrs "OFF"
Damp Heat with Load	$\Delta R \pm 0.4\%$	MIL-STD-202 Method 103 40 $\pm$ 2°C, 90~95% R.H. RCWV for 1000 hrs with 1.5 hrs "ON" and 0.5 hrs "OFF"
Solderability	95% min. coverage	MIL-STD-202 Method 208 245 $\pm$ 5°C for 3 seconds
Resistance to Soldering Heat	$\Delta R \pm 0.2\%$	MIL-STD-202 Method 210 260 $\pm$ 5°C for 10 seconds
Low Temperature Operation	$\Delta R \pm 0.2\%$	JIS-C-5201-1 4.36 1 hour, -65°C, followed by 45 minutes of RCWV
High Temperature Exposure	$\Delta R \pm 0.2\%$	MIL-STD-202 Method 108 At +155°C for 1000 hours
Thermal Shock	$\Delta R \pm 0.2\%$	MIL-STD-202F Method 107 -55°C ~ 150°C, 100 cycles

RCWV (Rated continuous working voltage) =  $\sqrt{P \cdot R}$  or Max. Operating voltage whichever is lower

Reference Standards: MIL-STD-202, JIS-C 5201

Storage Temperature: 25 $\pm$ 3°C; Humidity < 80%RH

Shelf Life: 2 years from date of production

## Construction and Dimensions

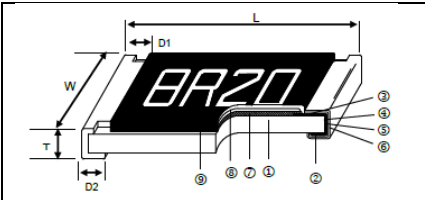
	①	Alumina Nitride Substrate	④	Edge Electrode	⑦	Resistor Layer
	②	Bottom Electrode	⑤	Barrier Layer	⑧	Overcoat
	③	Top Electrode	⑥	External Electrode	⑨	Marking

Size	L (mm)	W (mm)	T (mm)	D1 (mm)	D2 (mm)	Weight (g) 1000 Pcs
1206	3.05 $\pm$ 0.20	1.55 $\pm$ 0.20	0.43 $\pm$ 0.15	0.50 $\pm$ 0.15	1.20 $\pm$ 0.20	10.98

### Recommended PCB Plan

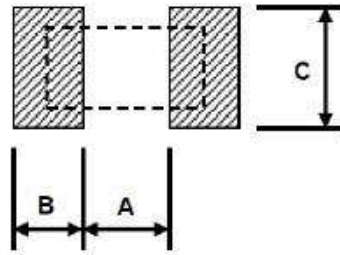

Size	A (mm)	B (mm)	C (mm)
1206	0.60	1.90	1.80±0.1

NB. Use a PCB with a copper thickness of two ounces

### Solder Profile (IPC/JEDEC J-STD-020)

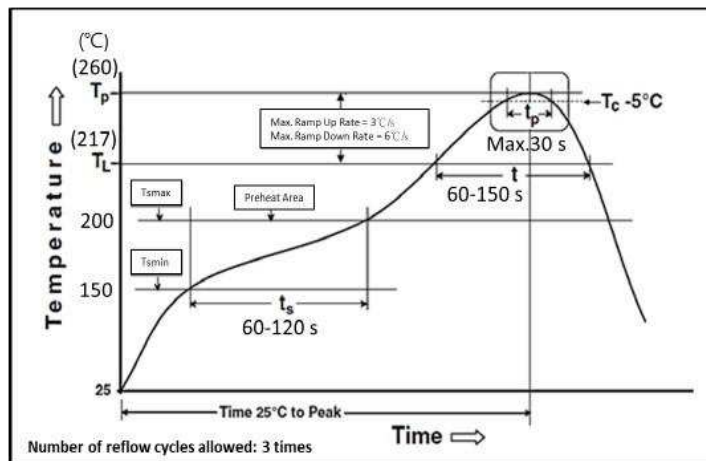

### Marking

4 digit marking – 3 significant figures plus multiplier

Resistance	500Ω	2.2KΩ	10KΩ	12.5KΩ
Marking	5000	2201	1002	1252

### Packaging

#### Reel Specification

∅A	∅B	∅C	W	T	Qty
178.0	60.0	13.5	9.5	11.5	1000
±1.0	±1.0	±0.7	±1.0	±1.0	5000

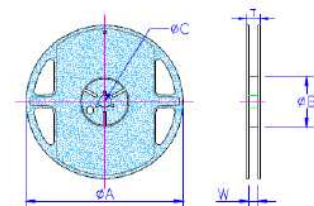

**Paper Tape Specification**

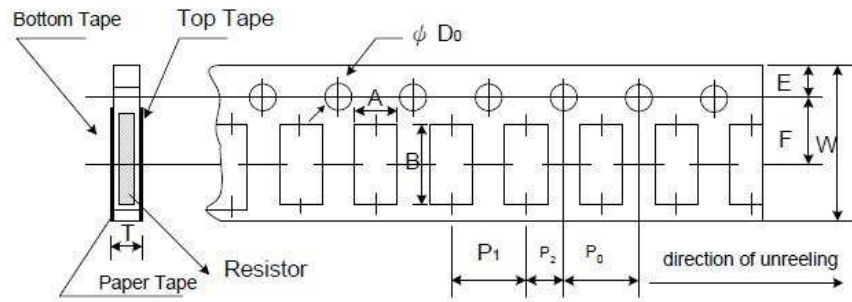

A±0.05	B±0.05	W±0.10	E±0.05	F±0.05	P <sub>0</sub> ±0.1	P <sub>1</sub> ±0.1	P <sub>2</sub> ±0.05	∅D <sub>0</sub> ±0.05	T±0.05
2.00	3.55	8.00	1.75	3.50	4.00	4.00	2.00	1.55	0.75

- Peel force of top cover tape
- The peel speed shall be about 300mm/min±5%
- The peel force of top cover tape shall be between 8gf to 60gf

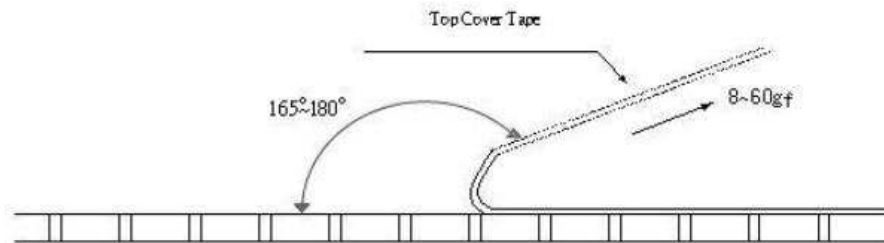

**How to Order**

3503	G	2B	10K	F	TDF
Common Part	TCR	Size	Resistance value	Tolerance	Packaging
3503 – High Power Thin Film Chip Resistor	G – 50ppm	2B - 1206	100R - 100Ω 1K0 - 1000Ω 10K – 10,000Ω	F – 1%	TDF – 1K RL TD – 5K RL

# Mouser Electronics

Authorized Distributor

Click to View Pricing, Inventory, Delivery & Lifecycle Information:

[TE Connectivity:](#)

[3503G2B61R9FTD](#)