

LDO Regulator - Ultra-Low Noise, High PSRR, RF and Analog Circuits

250 mA

NCP163

The NCP163 is a next generation of high PSRR, ultra-low noise LDO capable of supplying 250 mA output current. Designed to meet the requirements of RF and sensitive analog circuits, the NCP163 device provides ultra-low noise, high PSRR and low quiescent current. The device also offer excellent load/line transients. The NCP163 is designed to work with a 1 μ F input and a 1 μ F output ceramic capacitor. It is available in two thickness ultra-small 0.35P, WLCSP Packages, XDFN4 0.65P and industry standard SOT23-5L.

Features

- Operating Input Voltage Range: 2.2 V to 5.5 V
- Available in Fixed Voltage Option: 1.2 V to 5.3 V
- $\pm 2\%$ Accuracy Over Load/Temperature
- Ultra Low Quiescent Current Typ. 12 μ A
- Standby Current: Typ. 0.1 μ A
- Very Low Dropout: 80 mV at 250 mA
- Ultra High PSRR: Typ. 92 dB at 20 mA, f = 1 kHz
- Ultra Low Noise: 6.5 μ V_{RMS}
- Stable with a 1 μ F Small Case Size Ceramic Capacitors
- Available in – WLCSP4: 0.64 mm x 0.64 mm x 0.33 mm
– WLCSP4: 0.64 mm x 0.64 mm x 0.4 mm
– XDFN4: 1 mm x 1 mm x 0.4 mm
– SOT23-5: 2.9 mm x 2.8 mm x 1.2 mm
- These Devices are Pb-Free, Halogen Free/BFR Free and are RoHS Compliant

Typical Applications

- Battery-powered Equipment
- Wireless LAN Devices
- Smartphones, Tablets
- Cameras, DVRs, STB and Camcorders

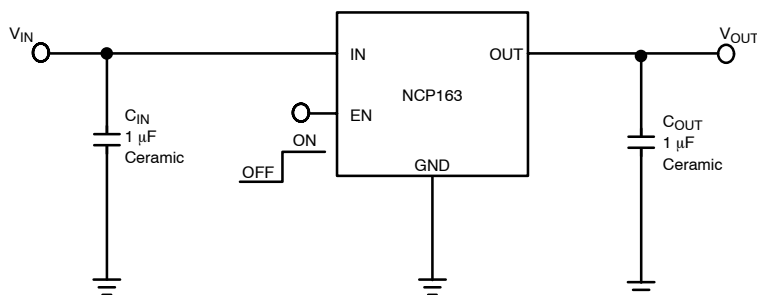
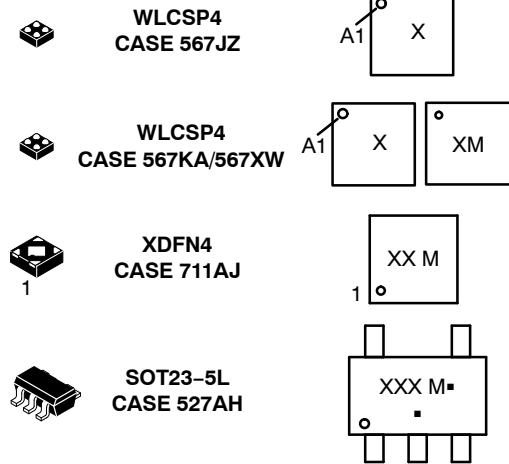

Figure 1. Typical Application Schematics

MARKING DIAGRAMS



X, XXX = Specific Device Code
M = Date Code
▪ = Pb-Free Package

(Note: Microdot may be in either location)

PIN CONNECTIONS

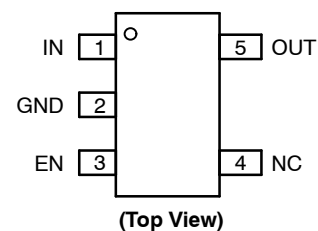
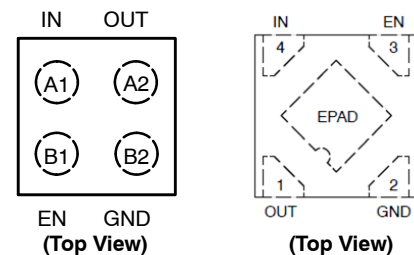

ORDERING INFORMATION

See detailed ordering, marking and shipping information on page 18 of this data sheet.

NCP163

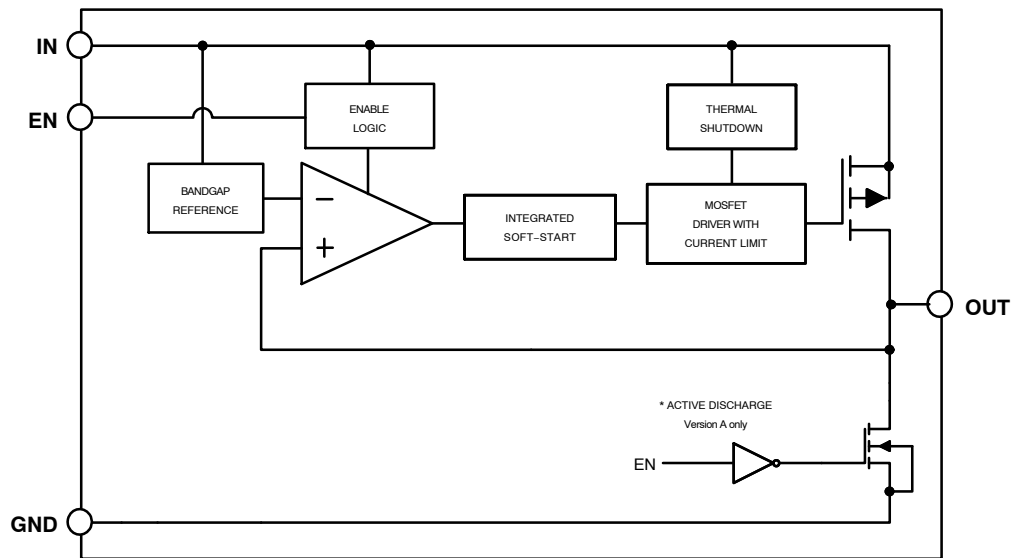

Figure 2. Simplified Schematic Block Diagram

PIN FUNCTION DESCRIPTION

Pin No. WLCSP4	Pin No. SOT23-5L	Pin No. XDFN4	Pin Name	Description
A1	1	4	IN	Input voltage supply pin
A2	5	1	OUT	Regulated output voltage. The output should be bypassed with small 1 μ F ceramic capacitor.
B1	3	3	EN	Chip enable: Applying $V_{EN} < 0.4$ V disables the regulator, Pulling $V_{EN} > 1.2$ V enables the LDO.
B2	2	2	GND	Common ground connection
-	4	-	NC	Not connected. Can be tied to ground plane.
-	-	EPAD	EPAD	Exposed pad. Can be tied to ground plane for better power dissipation.

ABSOLUTE MAXIMUM RATINGS

Rating	Symbol	Value	Unit
Input Voltage (Note 1)	V_{IN}	-0.3 V to 6	V
Output Voltage	V_{OUT}	-0.3 to $V_{IN} + 0.3$, max. 6 V	V
Chip Enable Input	V_{CE}	-0.3 to 6 V	V
Output Short Circuit Duration	t_{SC}	unlimited	s
Maximum Junction Temperature	T_J	150	$^{\circ}$ C
Storage Temperature	T_{STG}	-55 to 150	$^{\circ}$ C
ESD Capability, Human Body Model (Note 2)	ESD_{HBM}	2000	V
ESD Capability, Machine Model (Note 2)	ESD_{MM}	200	V
ESD Capability, Charged Device Model (Note 2)	ESD_{CDM}	1000	V

Stresses exceeding those listed in the Maximum Ratings table may damage the device. If any of these limits are exceeded, device functionality should not be assumed, damage may occur and reliability may be affected.

1. Refer to ELECTRICAL CHARACTERISTICS and APPLICATION INFORMATION for Safe Operating Area.

2. This device series incorporates ESD protection and is tested by the following methods:

ESD Human Body Model tested per EIA/JESD22-A114

ESD Machine Model tested per EIA/JESD22-A115

ESD Charged Device Model tested per EIA/JESD22-C101, Field Induced Charge Model

Latchup Current Maximum Rating tested per JEDEC standard: JESD78.

NCP163

THERMAL CHARACTERISTICS

Rating	Symbol	Value	Unit
Thermal Characteristics, WLCSP4 (Note 3), Thermal Resistance, Junction-to-Air	R _{θJA}	108	°C/W
Thermal Characteristics, XDFN4 (Note 3), Thermal Resistance, Junction-to-Air		198.1	
Thermal Characteristics, SOT23-5 (Note 3), Thermal Resistance, Junction-to-Air		218	

3. Measured according to JEDEC board specification. Detailed description of the board can be found in JESD51-7

ELECTRICAL CHARACTERISTICS $-40^{\circ}\text{C} \leq T_J \leq 125^{\circ}\text{C}$; $V_{IN} = V_{OUT(NOM)} + 1\text{ V}$; $I_{OUT} = 1\text{ mA}$, $C_{IN} = C_{OUT} = 1\text{ }\mu\text{F}$, unless otherwise noted. $V_{EN} = 1.2\text{ V}$. Typical values are at $T_J = +25^{\circ}\text{C}$ (Note 4).

Parameter	Test Conditions	Symbol	Min	Typ	Max	Unit
Operating Input Voltage		V_{IN}	2.2		5.5	V
Output Voltage Accuracy	$V_{IN} = (V_{OUT(NOM)} + 1\text{ V})$ to 5.5 V $0\text{ mA} \leq I_{OUT} \leq 250\text{ mA}$	V_{OUT}	-2		+2	%
	$V_{IN} = (V_{OUT(NOM)} + 1\text{ V})$ to 5.5 V $0\text{ mA} \leq I_{OUT} \leq 250\text{ mA}$ (for $V_{OUT} < 1.8\text{ V}$, XDFN4 package)		-3		+3	
	$V_{IN} = (V_{OUT(NOM)} + 1\text{ V})$ to 5.5 V SOT23-5L Package Only		-2		+2	
Line Regulation	$V_{OUT(NOM)} + 1\text{ V} \leq V_{IN} \leq 5.5\text{ V}$	LineReg		0.02		%/V
Load Regulation	$I_{OUT} = 1\text{ mA}$ to 250mA	WLCSP, XDFN4		0.001		%/mA
		SOT23-5L		0.008	0.015	
Dropout Voltage (Note 5)	$I_{OUT} = 250\text{ mA}$ (WLCSP, XDFN4 Packages)	$V_{OUT(NOM)} = 1.8\text{ V}$		180	250	mV
		$V_{OUT(NOM)} = 2.5\text{ V}$		110	175	
		$V_{OUT(NOM)} = 2.8\text{ V}$		95	160	
		$V_{OUT(NOM)} = 3.0\text{ V}$		90	155	
		$V_{OUT(NOM)} = 3.2\text{ V}$		85	149	
		$V_{OUT(NOM)} = 3.3\text{ V}$		80	145	
		$V_{OUT(NOM)} = 3.5\text{ V}$		75	140	
		$V_{OUT(NOM)} = 4.5\text{ V}$		65	120	
Dropout Voltage (Note 5)	$I_{OUT} = 250\text{ mA}$ (SOT23-5L Package)	$V_{OUT(NOM)} = 1.8\text{ V}$		205	280	mV
		$V_{OUT(NOM)} = 2.8\text{ V}$		120	190	
		$V_{OUT(NOM)} = 3.0\text{ V}$		115	185	
		$V_{OUT(NOM)} = 3.3\text{ V}$		105	175	
Output Current Limit	$V_{OUT} = 90\% V_{OUT(NOM)}$	I_{CL}	250	700		mA
Short Circuit Current	$V_{OUT} = 0\text{ V}$	I_{SC}		690		
Quiescent Current	$I_{OUT} = 0\text{ mA}$	I_Q		12	20	μA
Shutdown Current	$V_{EN} \leq 0.4\text{ V}$, $V_{IN} = 4.8\text{ V}$	I_{DIS}		0.01	1	μA
EN Pin Threshold Voltage	EN Input Voltage "H"	V_{ENH}	1.2			V
	EN Input Voltage "L"	V_{ENL}			0.4	
EN Pull Down Current	$V_{EN} = 4.8\text{ V}$	I_{EN}		0.2	0.5	μA
Turn-On Time	$C_{OUT} = 1\text{ }\mu\text{F}$, From assertion of V_{EN} to $V_{OUT} = 95\% V_{OUT(NOM)}$	"A" Option		120		μs
		"C" Option		135		
Power Supply Rejection Ratio	$I_{OUT} = 20\text{ mA}$	PSRR	$f = 100\text{ Hz}$	91		dB
	$f = 1\text{ kHz}$		92			
	$f = 10\text{ kHz}$		85			
	$f = 100\text{ kHz}$		60			

NCP163

ELECTRICAL CHARACTERISTICS $-40^{\circ}\text{C} \leq T_J \leq 125^{\circ}\text{C}$; $V_{IN} = V_{OUT(NOM)} + 1\text{ V}$; $I_{OUT} = 1\text{ mA}$, $C_{IN} = C_{OUT} = 1\text{ }\mu\text{F}$, unless otherwise noted. $V_{EN} = 1.2\text{ V}$. Typical values are at $T_J = +25^{\circ}\text{C}$ (Note 4).

Parameter	Test Conditions	Symbol	Min	Typ	Max	Unit
Output Voltage Noise	$f = 10\text{ Hz to }100\text{ kHz}$ $I_{OUT} = 1\text{ mA}$ $I_{OUT} = 250\text{ mA}$	V_N		8.0 6.5		μV_{RMS}
Thermal Shutdown Threshold	Temperature rising	T_{SDH}		160		$^{\circ}\text{C}$
	Temperature falling	T_{SDL}		140		$^{\circ}\text{C}$
Active Output Discharge Resistance	$V_{EN} < 0.4\text{ V}$, Version A only	R_{DIS}		280		Ω
Line Transient (Note 6)	$V_{IN} = (V_{OUT(NOM)} + 1\text{ V})$ to $(V_{OUT(NOM)} + 1.6\text{ V})$ in $30\text{ }\mu\text{s}$, $I_{OUT} = 1\text{ mA}$	Tran_{LINE}	-1			mV
	$V_{IN} = (V_{OUT(NOM)} + 1.6\text{ V})$ to $(V_{OUT(NOM)} + 1\text{ V})$ in $30\text{ }\mu\text{s}$, $I_{OUT} = 1\text{ mA}$				+1	
Load Transient (Note 6)	$I_{OUT} = 1\text{ mA to }200\text{ mA}$ in $10\text{ }\mu\text{s}$	Tran_{LOAD}	-40			mV
	$I_{OUT} = 200\text{ mA to }1\text{ mA}$ in $10\text{ }\mu\text{s}$				+40	

Product parametric performance is indicated in the Electrical Characteristics for the listed test conditions, unless otherwise noted. Product performance may not be indicated by the Electrical Characteristics if operated under different conditions.

4. Performance guaranteed over the indicated operating temperature range by design and/or characterization. Production tested at $T_A = 25^{\circ}\text{C}$. Low duty cycle pulse techniques are used during the testing to maintain the junction temperature as close to ambient as possible.
5. Dropout voltage is characterized when V_{OUT} falls 100 mV below $V_{OUT(NOM)}$.
6. Guaranteed by design.

TYPICAL CHARACTERISTICS

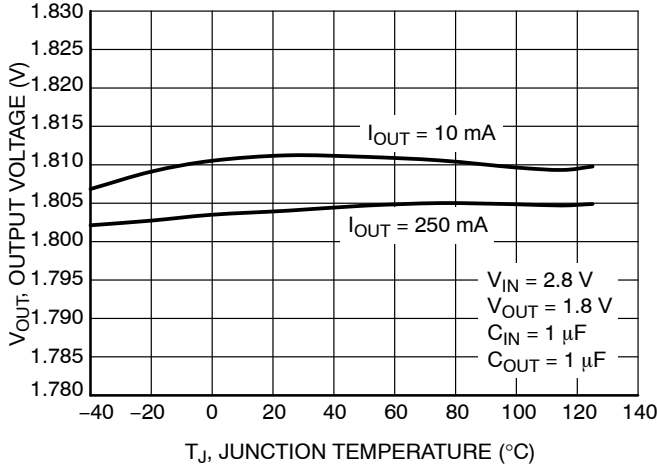

Figure 3. Output Voltage vs. Temperature – $V_{OUT} = 1.8\text{ V}$ – XDFN Package

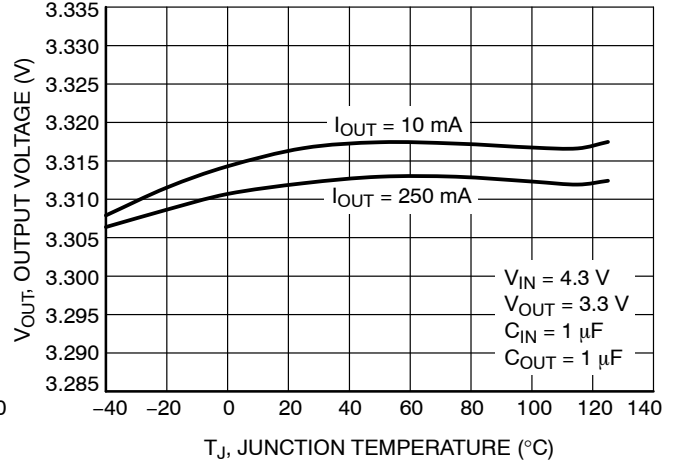

Figure 4. Output Voltage vs. Temperature – $V_{OUT} = 3.3\text{ V}$ – XDFN Package

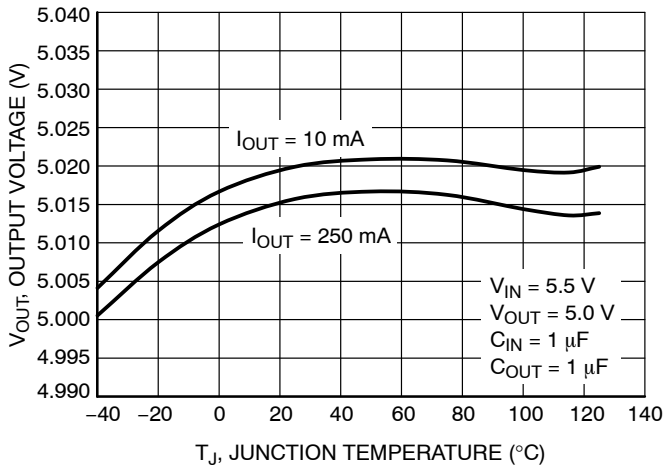

Figure 5. Output Voltage vs. Temperature – $V_{OUT} = 5.0\text{ V}$ – XDFN Package

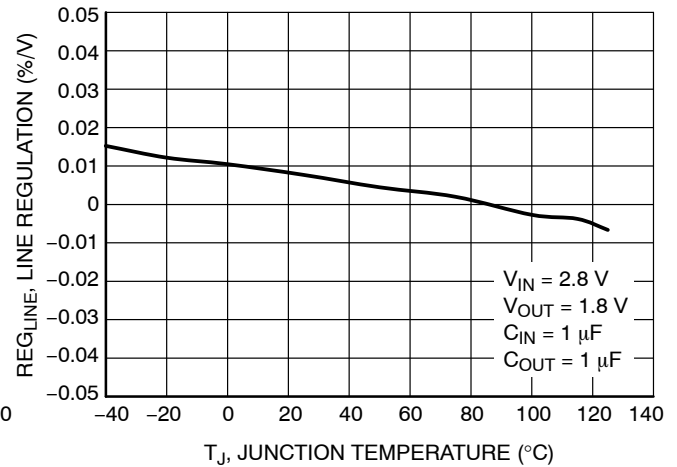

Figure 6. Line Regulation vs. Temperature – $V_{OUT} = 1.8\text{ V}$

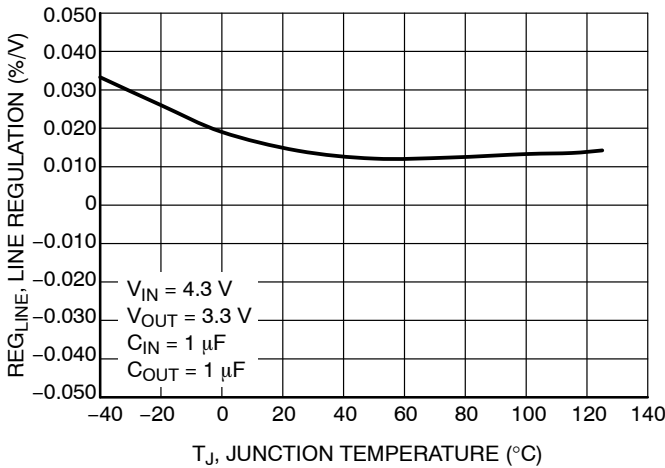

Figure 7. Line Regulation vs. Temperature – $V_{OUT} = 3.3\text{ V}$

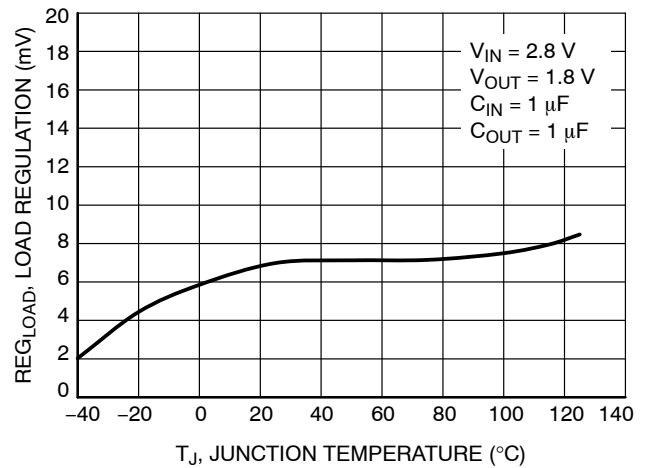

Figure 8. Load Regulation vs. Temperature – $V_{OUT} = 1.8\text{ V}$

TYPICAL CHARACTERISTICS

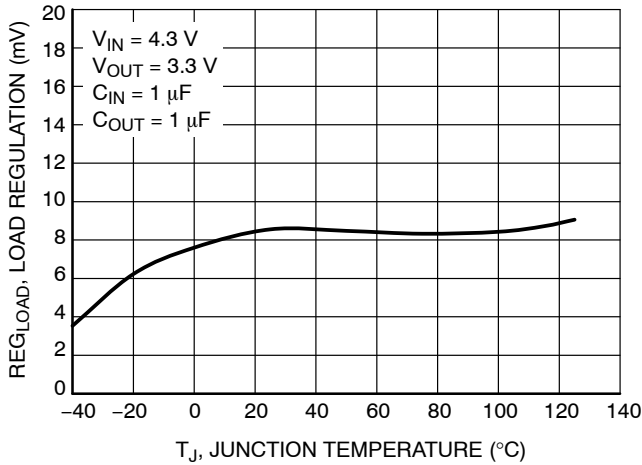

Figure 9. Load Regulation vs. Temperature - $V_{OUT} = 3.3\text{ V}$

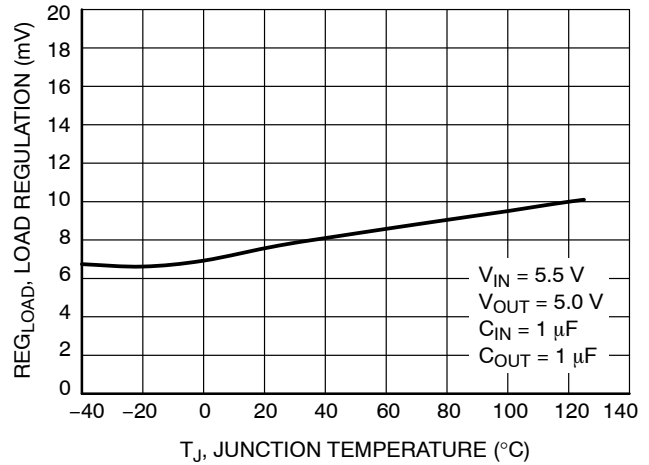

Figure 10. Load Regulation vs. Temperature - $V_{OUT} = 5.0\text{ V}$

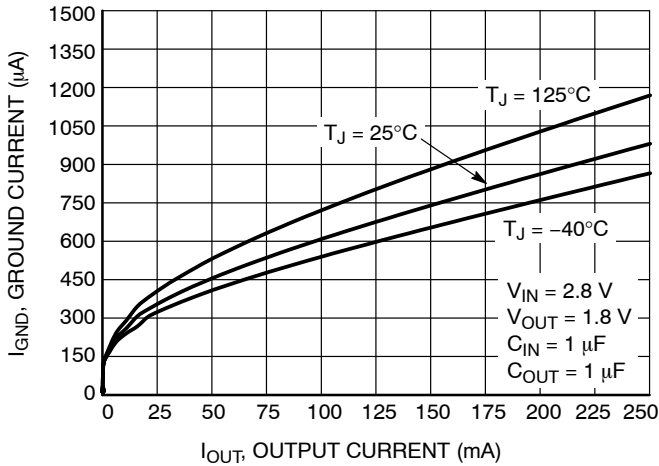

Figure 11. Ground Current vs. Load Current - $V_{OUT} = 1.8\text{ V}$

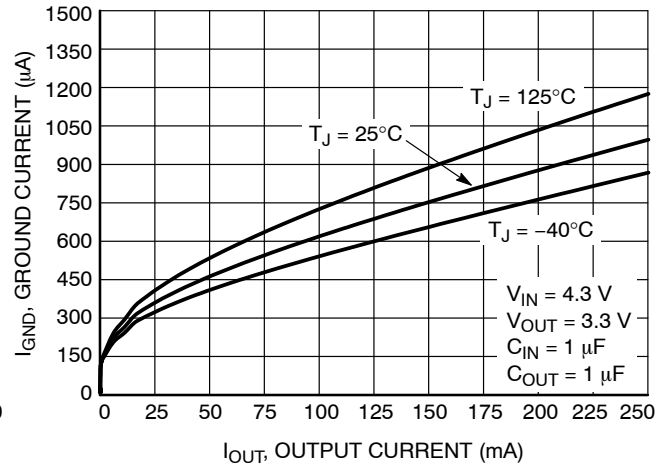

Figure 12. Ground Current vs. Load Current - $V_{OUT} = 3.3\text{ V}$

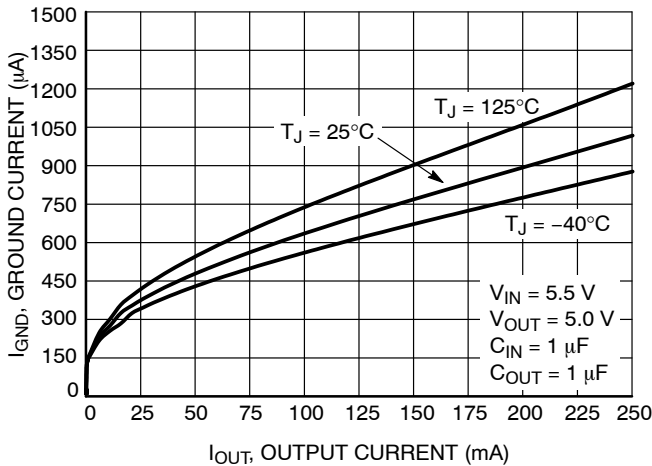

Figure 13. Ground Current vs. Load Current - $V_{OUT} = 5.0\text{ V}$

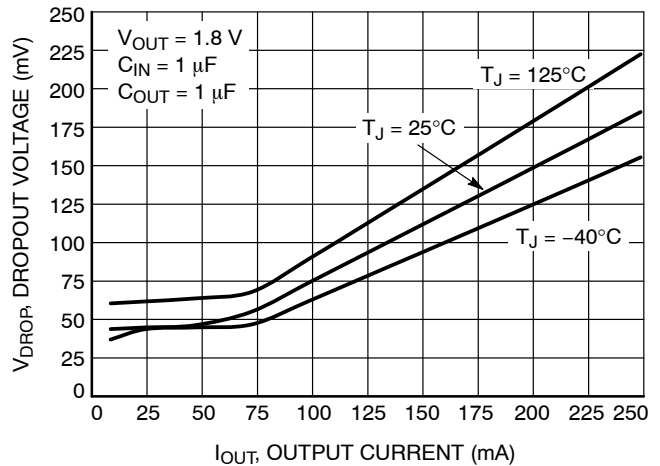

Figure 14. Dropout Voltage vs. Load Current - $V_{OUT} = 1.8\text{ V}$

TYPICAL CHARACTERISTICS

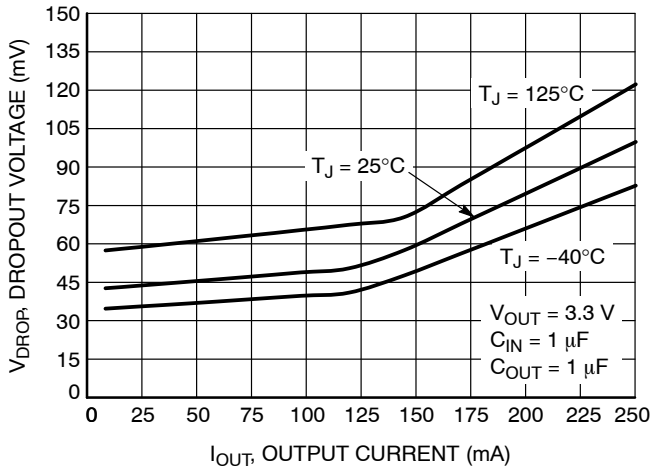

Figure 15. Dropout Voltage vs. Load Current – $V_{OUT} = 3.3\text{ V}$

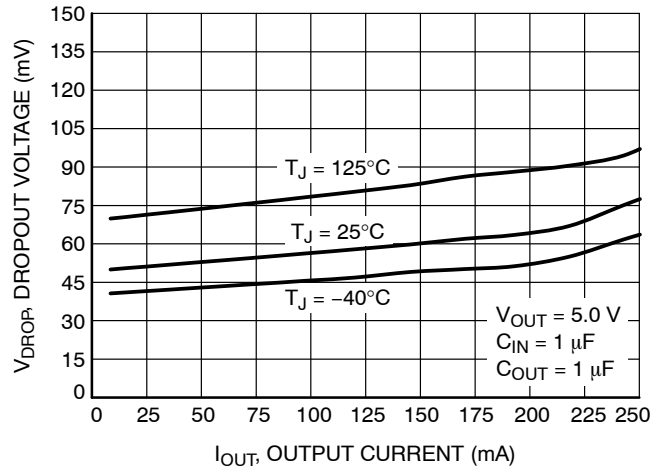

Figure 16. Dropout Voltage vs. Load Current – $V_{OUT} = 5.0\text{ V}$

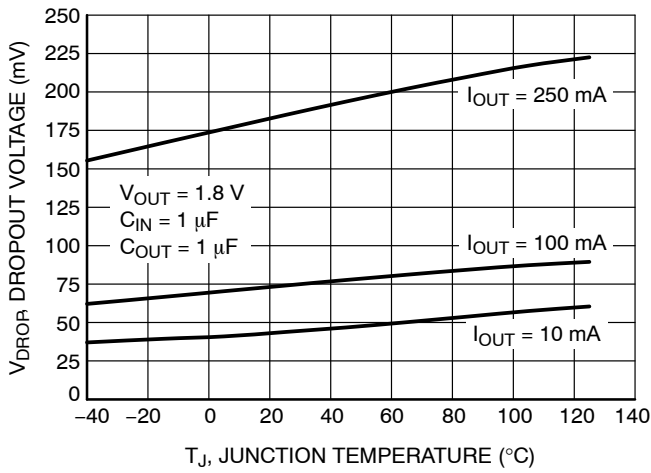

Figure 17. Dropout Voltage vs. Temperature – $V_{OUT} = 1.8\text{ V}$

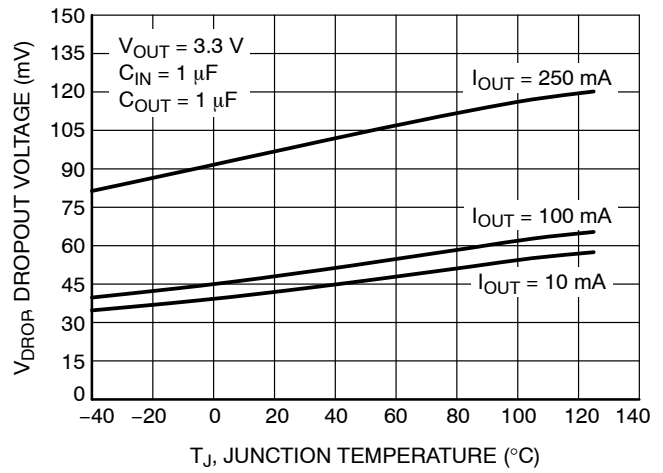

Figure 18. Dropout Voltage vs. Temperature – $V_{OUT} = 3.3\text{ V}$

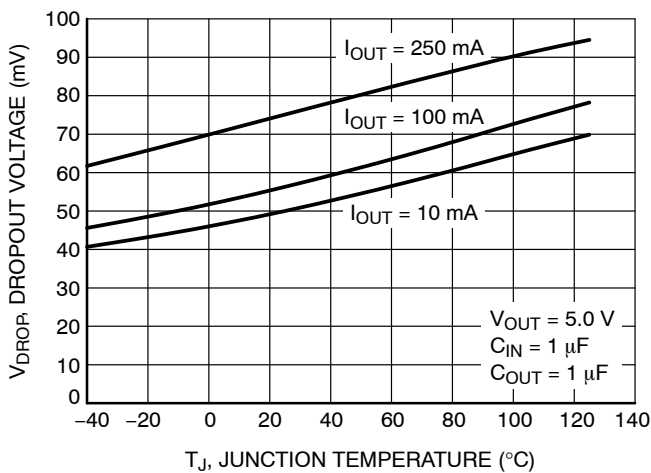

Figure 19. Dropout Voltage vs. Temperature – $V_{OUT} = 5.0\text{ V}$

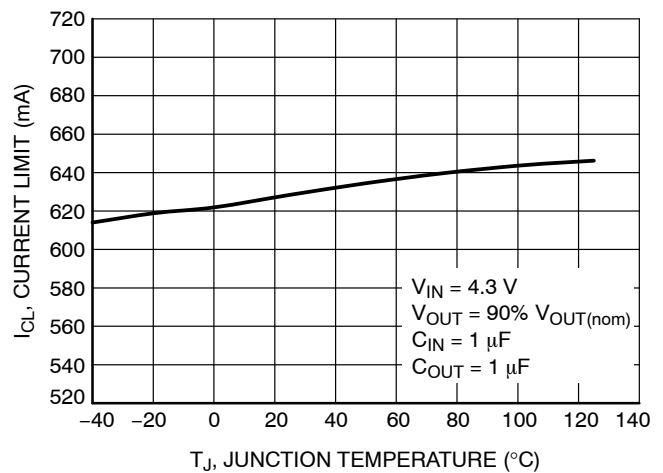

Figure 20. Current Limit vs. Temperature

TYPICAL CHARACTERISTICS

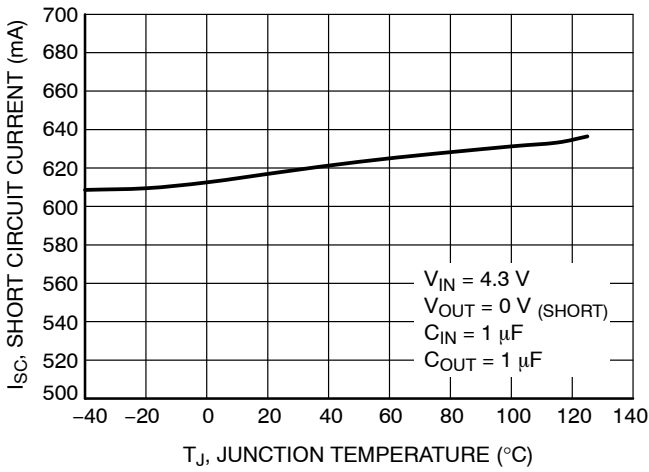

Figure 21. Short Circuit Current vs. Temperature

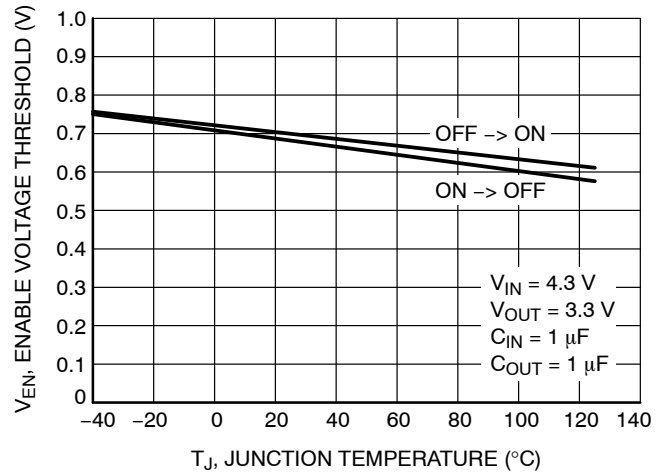

Figure 22. Enable Thresholds Voltage

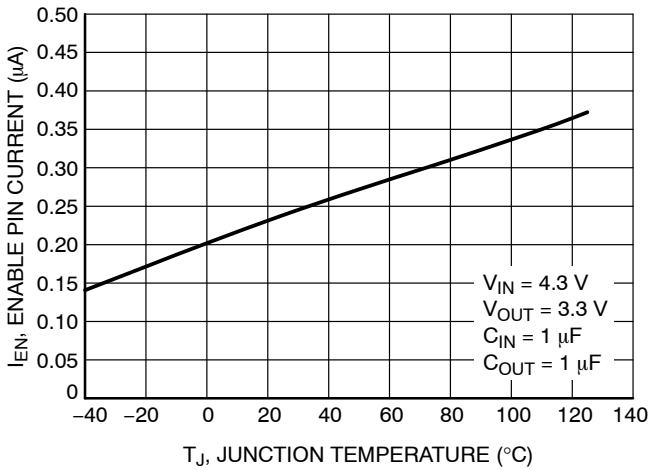

Figure 23. Current to Enable Pin vs. Temperature

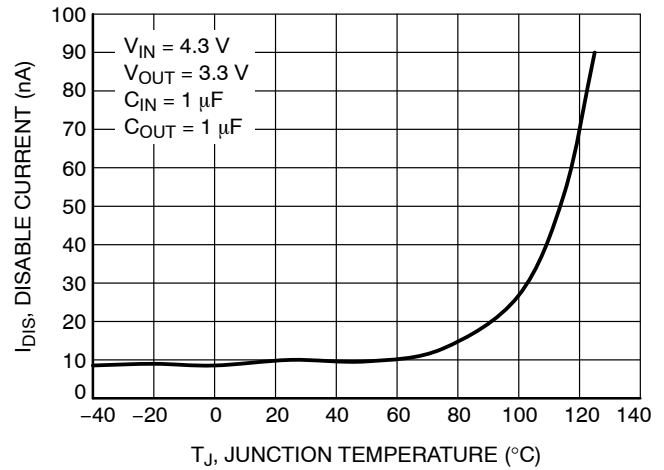

Figure 24. Disable Current vs. Temperature

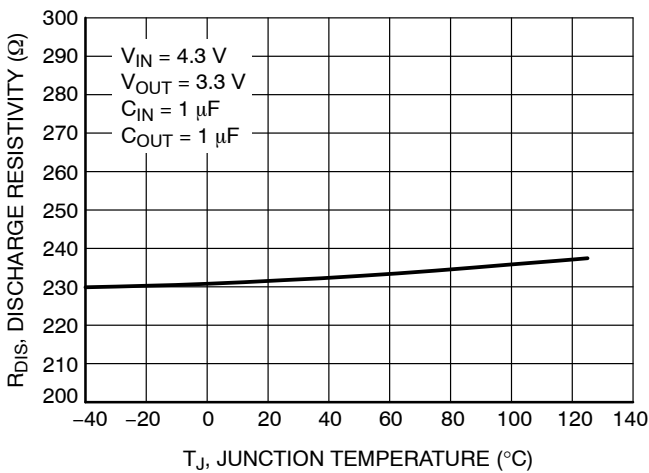

Figure 25. Discharge Resistance vs. Temperature

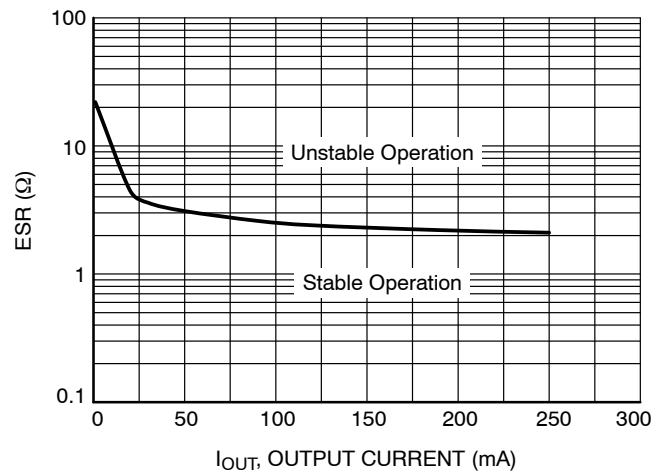
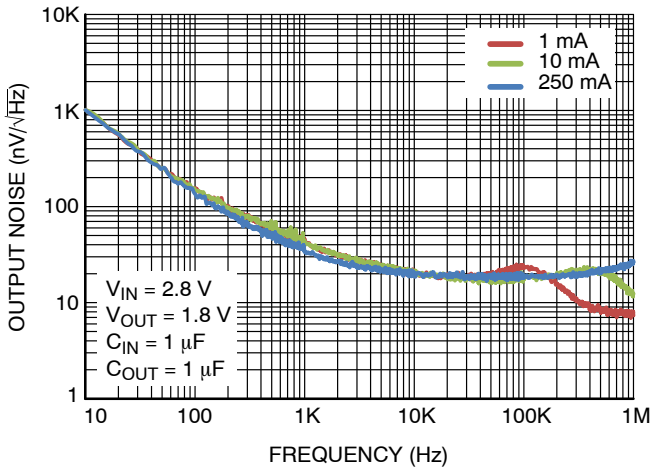

Figure 26. Maximum C_{OUT} ESR Value vs. Load Current

TYPICAL CHARACTERISTICS



I_{OUT}	RMS Output Noise (μV)	
	10 Hz - 100 kHz	100 Hz - 100 kHz
1 mA	7.73	6.99
10 mA	7.12	6.26
250 mA	7.11	6.33

Figure 27. Output Voltage Noise Spectral Density – $V_{OUT} = 1.8\text{ V}$

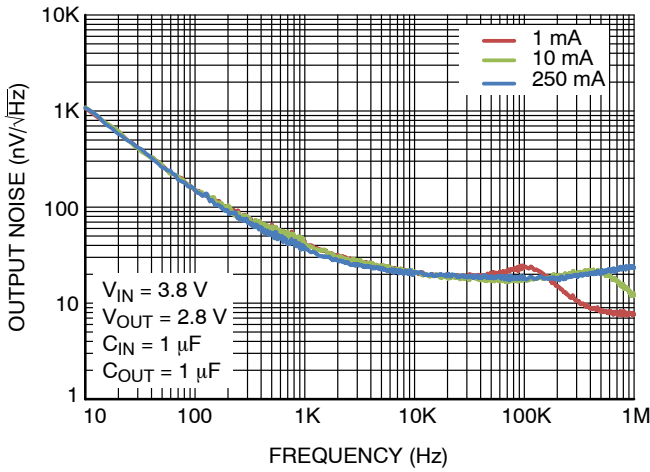

I_{OUT}	RMS Output Noise (μV)	
	10 Hz - 100 kHz	100 Hz - 100 kHz
1 mA	7.9	7.07
10 mA	7.19	6.25
250 mA	7.29	6.38

Figure 28. Output Voltage Noise Spectral Density – $V_{OUT} = 2.8\text{ V}$

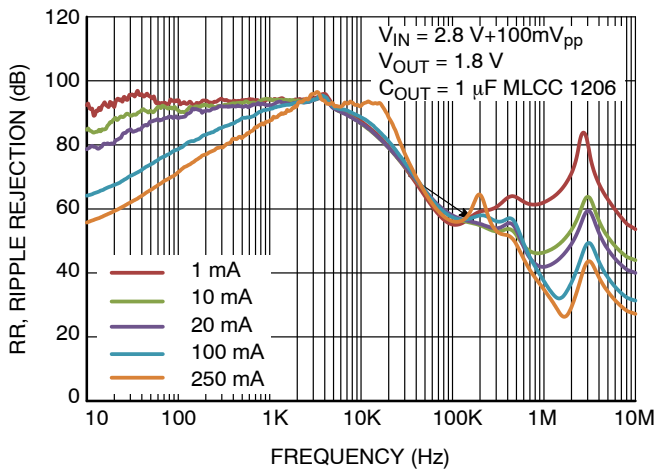

Figure 29. Power Supply Rejection Ratio – $V_{OUT} = 1.8\text{ V}$

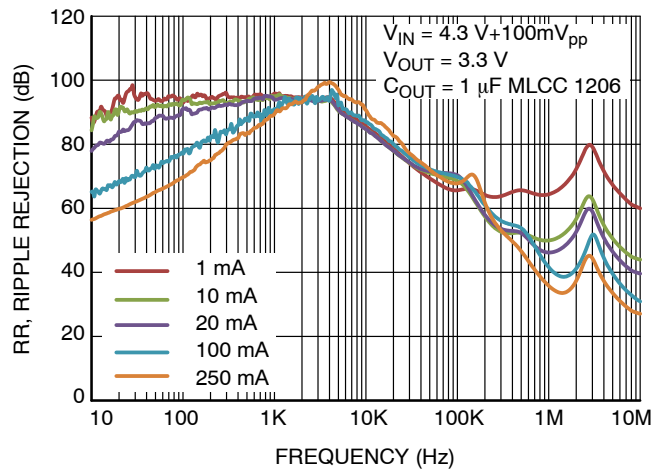

Figure 30. Power Supply Rejection Ratio – $V_{OUT} = 3.3\text{ V}$

TYPICAL CHARACTERISTICS

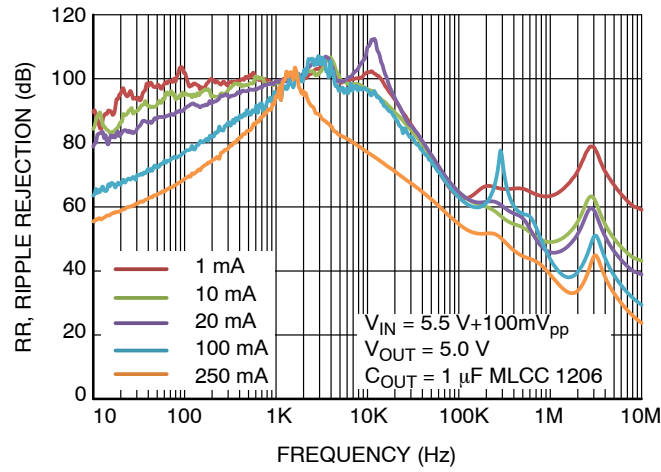

Figure 31. Power Supply Rejection Ratio – $V_{OUT} = 5.0\text{ V}$

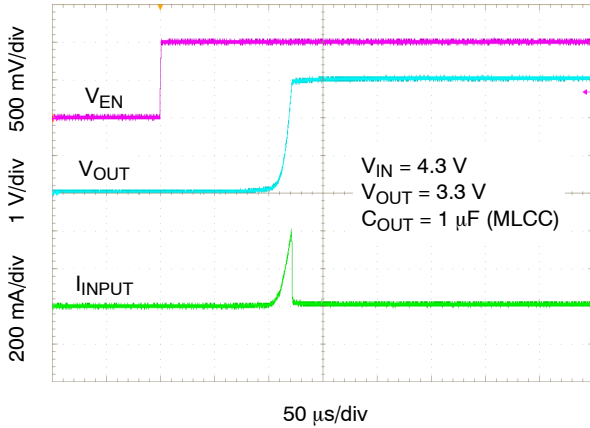

Figure 32. Enable Turn-on Response – $C_{OUT} = 1\ \mu\text{F}$, $I_{OUT} = 10\ \text{mA}$ – “A” Option

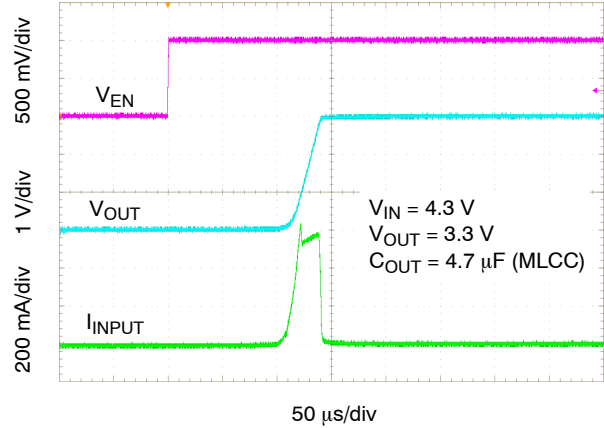

Figure 33. Enable Turn-on Response – $C_{OUT} = 4.7\ \mu\text{F}$, $I_{OUT} = 10\ \text{mA}$ – “A” Option

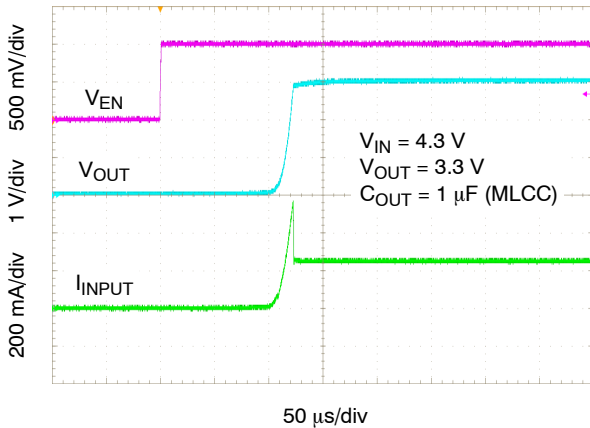

Figure 34. Enable Turn-on Response – $C_{OUT} = 1\ \mu\text{F}$, $I_{OUT} = 250\ \text{mA}$ – “A” Option

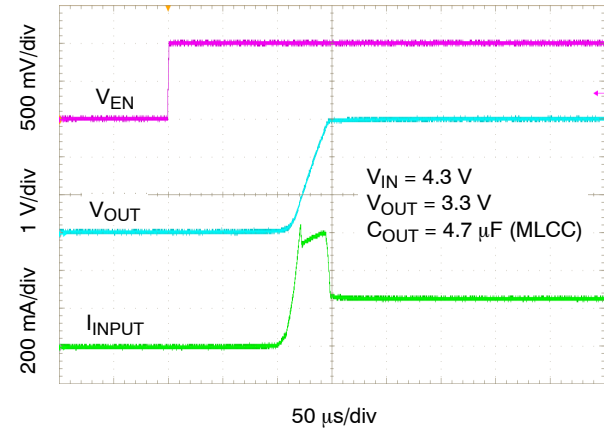
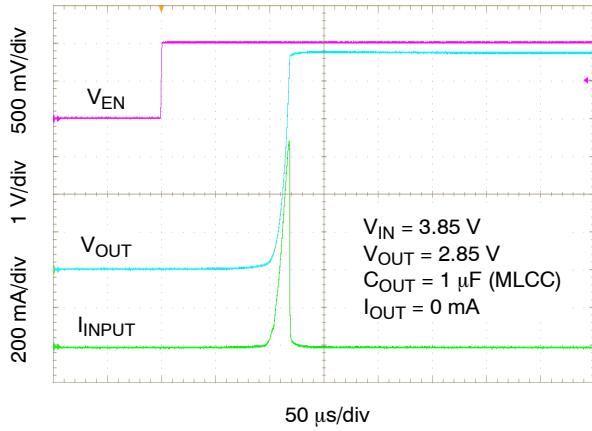

Figure 35. Enable Turn-on Response – $C_{OUT} = 4.7\ \mu\text{F}$, $I_{OUT} = 250\ \text{mA}$ – “A” Option

NCP163

TYPICAL CHARACTERISTICS



**Figure 36. Enable Turn-on Response –
 $C_{OUT} = 1\ \mu\text{F}$ – “A” Option – Normal**

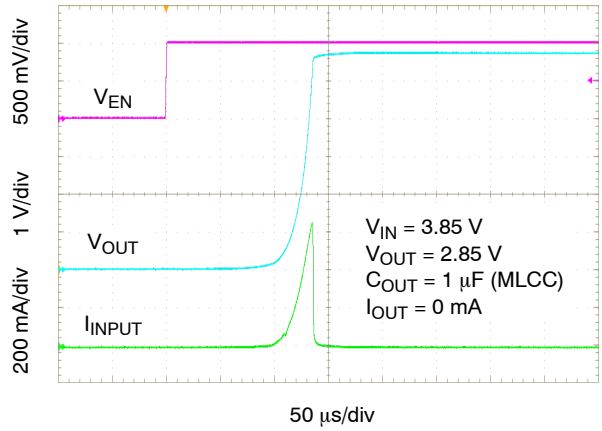

**Figure 37. Enable Turn-on Response –
 $C_{OUT} = 1\ \mu\text{F}$ – “C” Option – Slow**

TYPICAL CHARACTERISTICS

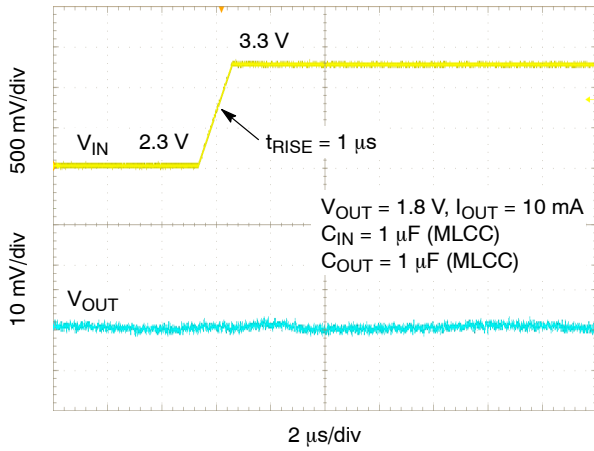

Figure 38. Line Transient Response – $I_{OUT} = 10 \text{ mA}$

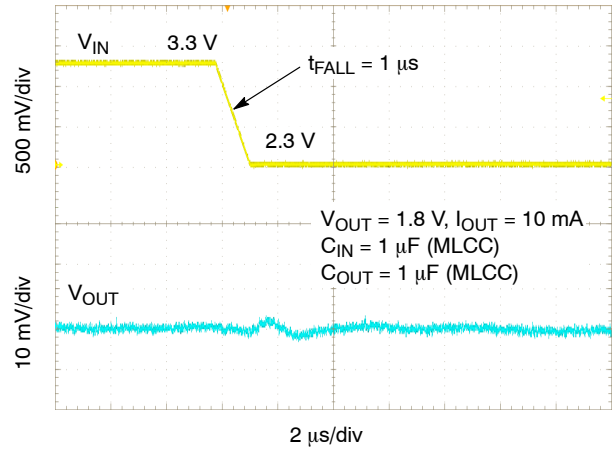

Figure 39. Line Transient Response – $I_{OUT} = 10 \text{ mA}$

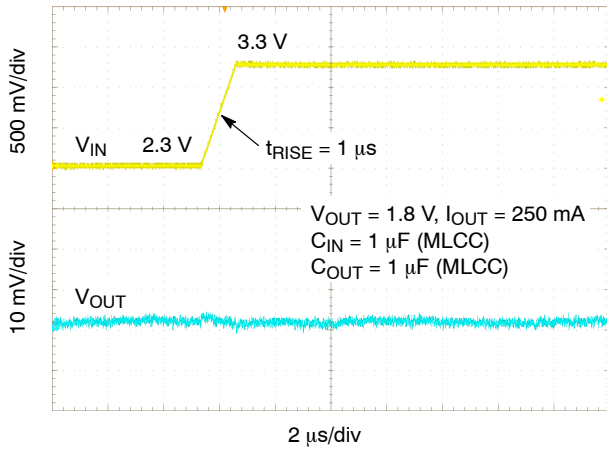

Figure 40. Line Transient Response – $I_{OUT} = 250 \text{ mA}$

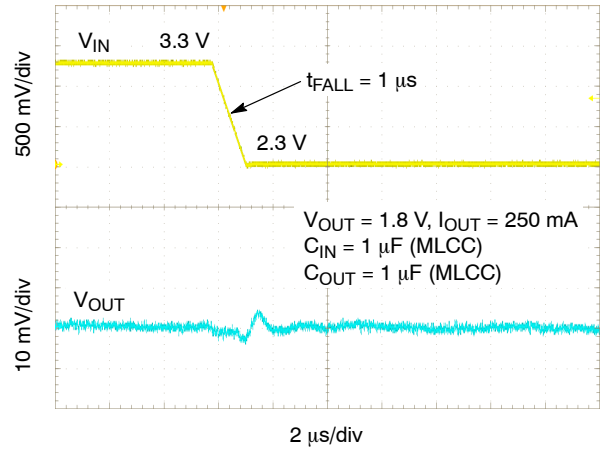

Figure 41. Line Transient Response – $I_{OUT} = 250 \text{ mA}$

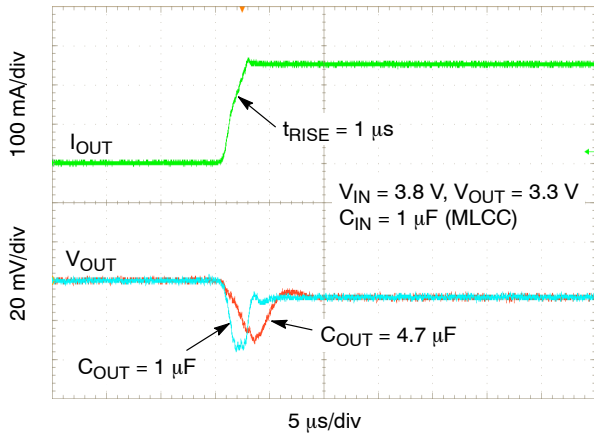

Figure 42. Load Transient Response – $1 \text{ mA to } 250 \text{ mA}$

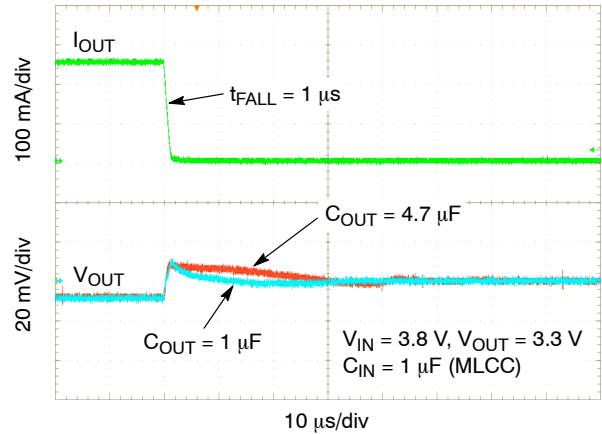

Figure 43. Load Transient Response – $250 \text{ mA to } 1 \text{ mA}$

TYPICAL CHARACTERISTICS

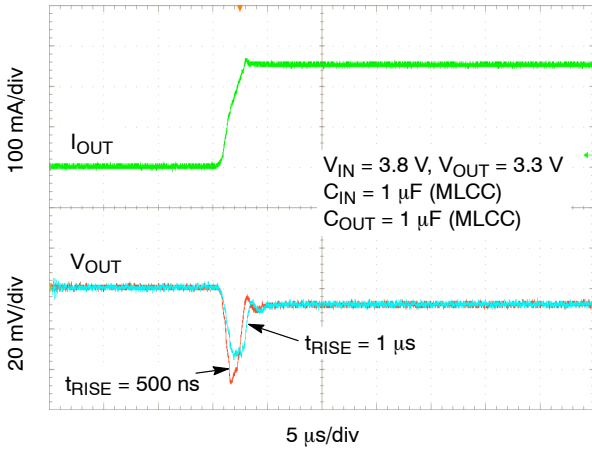

Figure 44. Load Transient Response – 1 mA to 250 mA

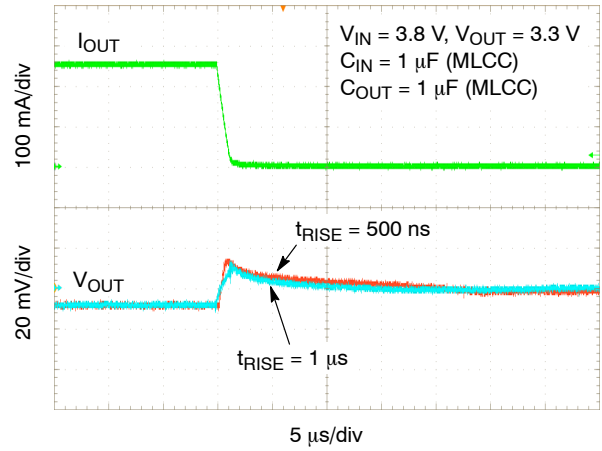

Figure 45. Load Transient Response – 250 mA to 1 mA

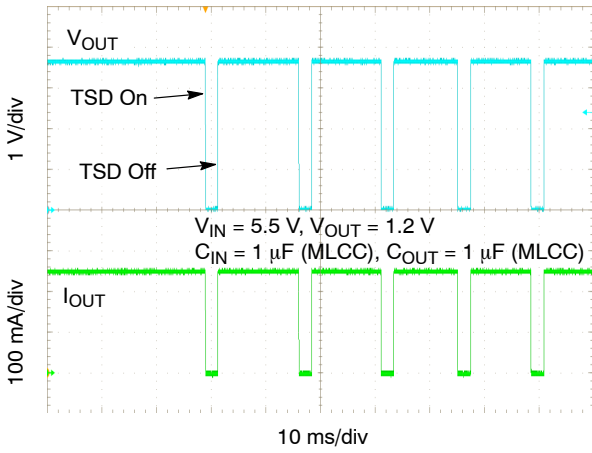

Figure 46. Overheating Protection – TSD

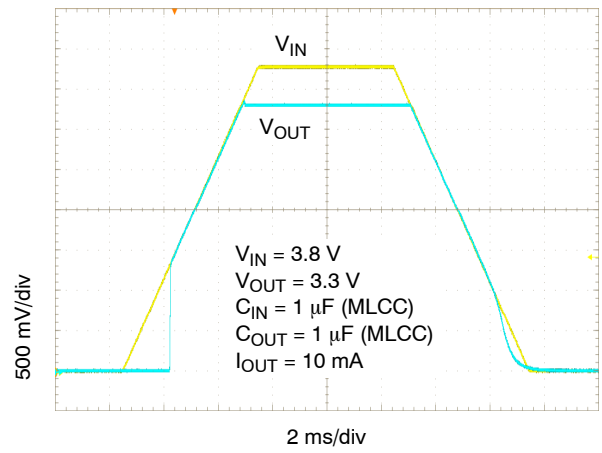

Figure 47. Turn-on/off – Slow Rising V_{IN}

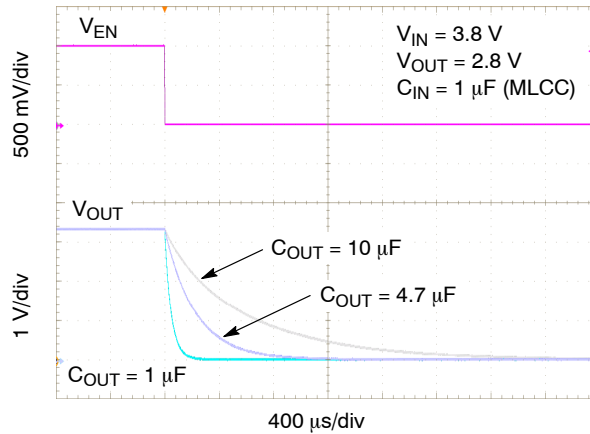

Figure 48. Enable Turn-off – Various Output Capacitors

APPLICATIONS INFORMATION

General

The NCP163 is an ultra-low noise 250 mA low dropout regulator designed to meet the requirements of RF applications and high performance analog circuits. The NCP163 device provides very high PSRR and excellent dynamic response. In connection with low quiescent current this device is well suitable for battery powered application such as cell phones, tablets and other. The NCP163 is fully protected in case of current overload, output short circuit and overheating.

Input Capacitor Selection (C_{IN})

Input capacitor connected as close as possible is necessary for ensure device stability. The X7R or X5R capacitor should be used for reliable performance over temperature range. The value of the input capacitor should be 1 μF or greater to ensure the best dynamic performance. This capacitor will provide a low impedance path for unwanted AC signals or noise modulated onto constant input voltage. There is no requirement for the ESR of the input capacitor but it is recommended to use ceramic capacitors for their low ESR and ESL. A good input capacitor will limit the influence of input trace inductance and source resistance during sudden load current changes.

Output Decoupling (C_{OUT})

The NCP163 requires an output capacitor connected as close as possible to the output pin of the regulator. The recommended capacitor value is 1 μF and X7R or X5R dielectric due to its low capacitance variations over the specified temperature range. The NCP163 is designed to remain stable with minimum effective capacitance of 0.7 μF to account for changes with temperature, DC bias and package size. Especially for small package size capacitors such as 0201 the effective capacitance drops rapidly with the applied DC bias. Please refer Figure 49.

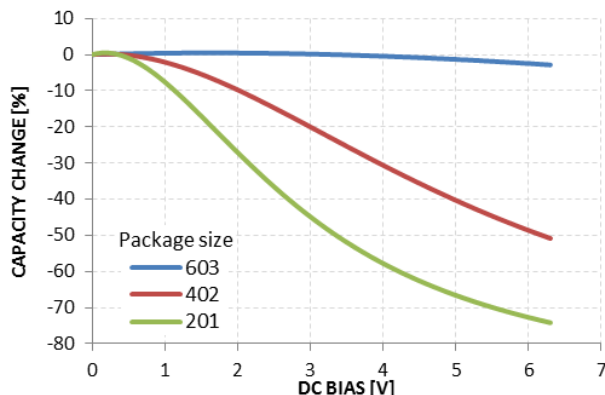

Figure 49. Capacity vs DC Bias Voltage

There is no requirement for the minimum value of Equivalent Series Resistance (ESR) for the C_{OUT} but the maximum value of ESR should be less than 2 Ω. Larger output capacitors and lower ESR could improve the load

transient response or high frequency PSRR. It is not recommended to use tantalum capacitors on the output due to their large ESR. The equivalent series resistance of tantalum capacitors is also strongly dependent on the temperature, increasing at low temperature.

Enable Operation

The NCP163 uses the EN pin to enable/disable its device and to deactivate/activate the active discharge function.

If the EN pin voltage is <0.4 V the device is guaranteed to be disabled. The pass transistor is turned-off so that there is virtually no current flow between the IN and OUT. The active discharge transistor is active so that the output voltage V_{OUT} is pulled to GND through a 280 Ω resistor. In the disable state the device consumes as low as typ. 10 nA from the V_{IN}.

If the EN pin voltage >1.2 V the device is guaranteed to be enabled. The NCP163 regulates the output voltage and the active discharge transistor is turned-off.

The EN pin has internal pull-down current source with typ. value of 200 nA which assures that the device is turned-off when the EN pin is not connected. In the case where the EN function isn't required the EN should be tied directly to IN.

The NCP163 provides soft-start feature ensures smooth monotonous output voltage rising. It prevents excessive input current after EN pin turn-on when big output capacitance is connected.

There are two slew-rate options of start-up ramp. The normal "A" option and slower "C" option. For more information please refer ordering information table.

Output Current Limit

Output Current is internally limited within the IC to a typical 700 mA. The NCP163 will source this amount of current measured with a voltage drops on the 90% of the nominal V_{OUT}. If the Output Voltage is directly shorted to ground (V_{OUT} = 0 V), the short circuit protection will limit the output current to 690 mA (typ). The current limit and short circuit protection will work properly over whole temperature range and also input voltage range. There is no limitation for the short circuit duration.

Thermal Shutdown

When the die temperature exceeds the Thermal Shutdown threshold (T_{SD} – 160°C typical), Thermal Shutdown event is detected and the device is disabled. The IC will remain in this state until the die temperature decreases below the Thermal Shutdown Reset threshold (T_{SDU} – 140°C typical). Once the IC temperature falls below the 140°C the LDO is enabled again. The thermal shutdown feature provides the protection from a catastrophic device failure due to accidental overheating. This protection is not intended to be used as a substitute for proper heat sinking.

NCP163

Power Dissipation

As power dissipated in the NCP163 increases, it might become necessary to provide some thermal relief. The maximum power dissipation supported by the device is dependent upon board design and layout. Mounting pad configuration on the PCB, the board material, and the ambient temperature affect the rate of junction temperature rise for the part.

The maximum power dissipation the NCP163 can handle is given by:

$$P_{D(MAX)} = \frac{[125^{\circ}\text{C} - T_A]}{\theta_{JA}} \quad (\text{eq. 1})$$

The power dissipated by the NCP163 for given application conditions can be calculated from the following equations:

$$P_D \approx V_{IN} \cdot I_{GND} + I_{OUT}(V_{IN} - V_{OUT}) \quad (\text{eq. 2})$$

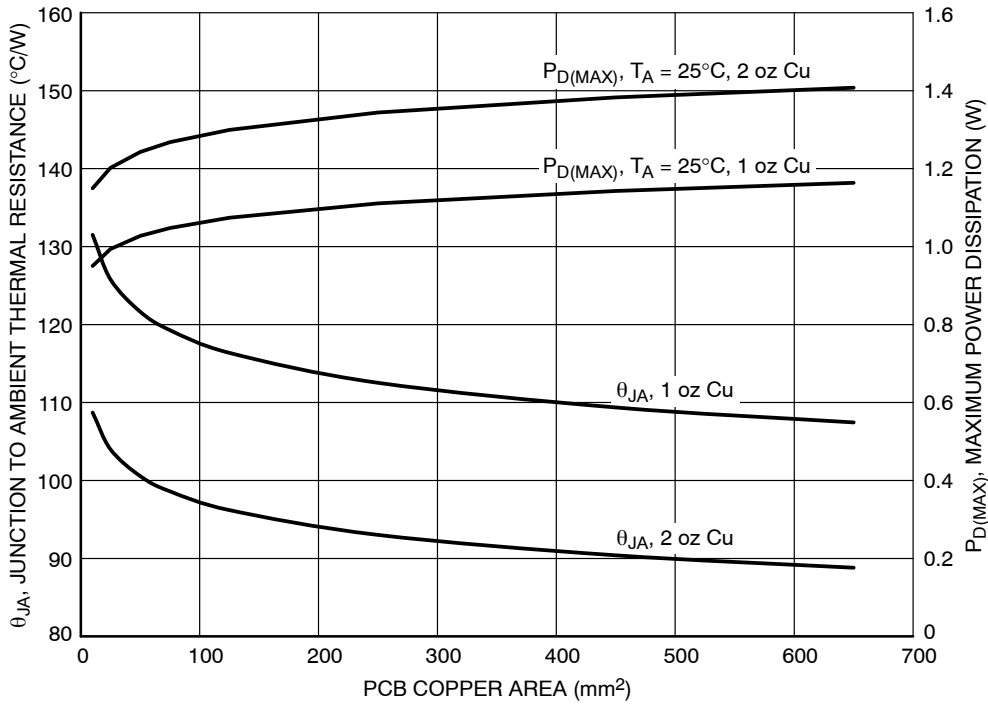

Figure 50. θ_{JA} and $P_{D(MAX)}$ vs. Copper Area (CSP4)

NCP163

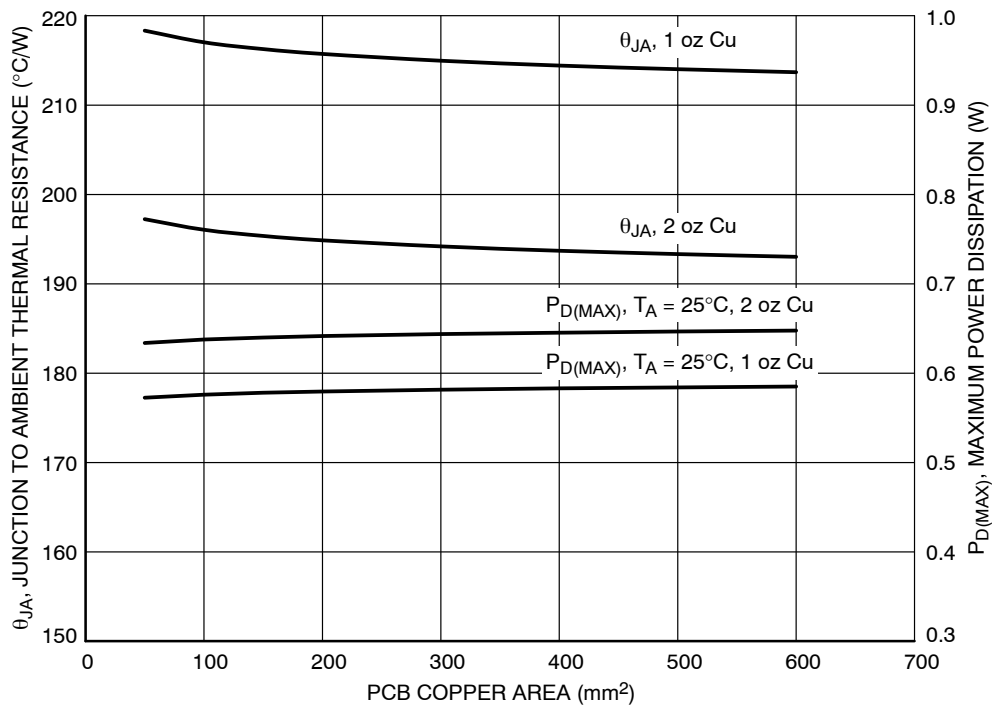

Figure 51. θ_{JA} and $P_{D(MAX)}$ vs. Copper Area (XDFN4)

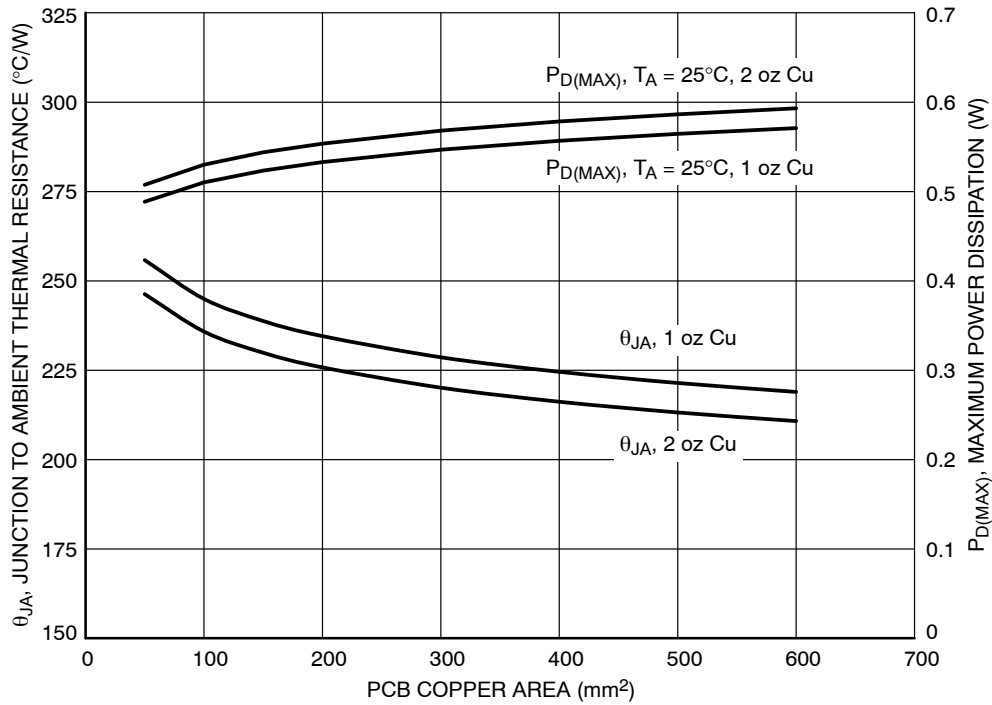

Figure 52. θ_{JA} and $P_{D(MAX)}$ vs. Copper Area (SOT23-5L)

NCP163

Reverse Current

The PMOS pass transistor has an inherent body diode which will be forward biased in the case that $V_{OUT} > V_{IN}$. Due to this fact in cases, where the extended reverse current condition can be anticipated the device may require additional external protection.

Power Supply Rejection Ratio

The NCP163 features very high Power Supply Rejection ratio. If desired the PSRR at higher frequencies in the range 100 kHz – 10 MHz can be tuned by the selection of C_{OUT} capacitor and proper PCB layout.

Turn-On Time

The turn-on time is defined as the time period from EN assertion to the point in which V_{OUT} will reach 98% of its nominal value. This time is dependent on various application conditions such as $V_{OUT(NOM)}$, C_{OUT} , T_A .

PCB Layout Recommendations

To obtain good transient performance and good regulation characteristics place C_{IN} and C_{OUT} capacitors close to the device pins and make the PCB traces wide. In order to minimize the solution size, use 0402 or 0201 capacitors with appropriate capacity. Larger copper area connected to the pins will also improve the device thermal resistance. The actual power dissipation can be calculated from the equation above (Equation 2). Expose pad can be tied to the GND pin for improvement power dissipation and lower device temperature.

NCP163

ORDERING INFORMATION (WLCSP4)

Device	Voltage Option	Marking	Rotation	Description	Package	Shipping [†]
NCP163AFCS120T2G	1.2 V	2	0	250 mA, Active Discharge	WLCSP4 CASE 567KA (Pb-Free)	5000 / Tape & Reel
NCP163AFCS180T2G	1.8 V	Y	180			
NCP163AFCS250T2G	2.5 V	T	270			
NCP163AFCS260T2G	2.6 V	4	180			
NCP163AFCS270T2G	2.7 V	V	270			
NCP163AFCS280T2G	2.8 V	3	180			
NCP163AFCS285T2G	2.85 V	5	180			
NCP163AFCS290T2G	2.9 V	6	180			
NCP163AFCS2925T2G	2.925 V	2	180			
NCP163BFCS180T2G	1.8 V	Y	270	250 mA, Non-Active Discharge		
NCP163BFCS2925T2G	2.925 V	2	270			
NCP163CFCS285T2G	2.85 V	P	180	250 mA, Active Discharge Slow Turn-On Slew	WLCSP4 CASE 567XW (Pb-Free)	10000 / Tape & Reel
NCP163AFCT120T2G	1.2 V	Ā	0	250 mA, Active Discharge	WLCSP4 CASE 567JZ (Pb-Free)	5000 or 10000 / Tape & Reel (Note 7)
NCP163AFCT180T2G	1.8 V	Y	180			
NCP163AFCT250T2G	2.5 V	Y	90			
NCP163AFCT260T2G	2.6 V	6	270			
NCP163AFCT270T2G	2.7 V	5	180			
NCP163AFCT280T2G	2.8 V	3	180			
NCP163AFCT285T2G	2.85 V	5	270			
NCP163AFCT290T2G	2.9 V	4	270			
NCP163AFCT2925T2G	2.925 V	2	180			
NCP163AFCT300T2G	3.0 V	3	270			
NCP163AFCT330T2G	3.3 V	6	90			
NCP163BFCT180T2G	1.8 V	Y	270	250 mA, Non-Active Discharge		
NCP163BFCT2925T2G	2.925 V	2	270			

[†]For information on tape and reel specifications, including part orientation and tape sizes, please refer to our Tape and Reel Packaging Specifications Brochure, [BRD8011/D](#).

7. Product processed after April 1, 2023 are shipped with quantity 10000 units / tape & reel.

NCP163

ORDERING INFORMATION (XDFN4)

Device	Voltage Option	Marking	Description	Package	Shipping [†]
NCP163AMX120TBG* (Note 8)	1.2 V	ME	250 mA, Active Discharge	XDFN4 CASE 711AJ (Pb-Free)	3000 or 5000 / Tape & Reel (Note 8)
NCP163AMX130TBG* (Note 8)	1.3 V	MG			
NCP163AMX150TBG	1.5 V	MV			
NCP163AMX180TBG (Note 8)	1.8 V	MA			
NCP163AMX1825TBG (Note 8)	1.825 V	MC			
NCP163AMX185TBG (In Development)	1.85 V	MZ			
NCP163AMX190TBG	1.9 V	MH			
NCP163AMX250TBG	2.5 V	MU			
NCP163AMX260TBG	2.6 V	MN			
NCP163AMX270TBG (Note 8)	2.7 V	MX			
NCP163AMX275TBG	2.75 V	MD			
NCP163AMX280TBG (Note 8)	2.8 V	MM			
NCP163AMX285TBG	2.85 V	MQ			
NCP163AMX290TBG (Note 8)	2.9 V	MR			
NCP163AMX300TBG (Note 8)	3.0 V	MJ			
NCP163AMX330TBG (Note 8)	3.3 V	MK			
NCP163AMX500TBG (Note 8)	5.0 V	ML			
NCP163BMX180TBG (Note 8)	1.8 V	PA	250 mA, Non-Active Discharge		
NCP163BMX1825TBG (Note 8)	1.825 V	PC			
NCP163BMX275TBG	2.75 V	PD			

†For information on tape and reel specifications, including part orientation and tape sizes, please refer to our Tape and Reel Packaging Specifications Brochure, [BRD8011/D](#).

*Contact sales office for availability information.

8. Product processed after October 1, 2022 are shipped with quantity 5000 units / tape & reel.

ORDERING INFORMATION (SOT23-5L)

Device	Voltage Option	Marking	Description	Package	Shipping [†]
NCP163ASN150T1G	1.5 V	KAK	250 mA, Active Discharge	SOT23-5L CASE 527AH (Pb-Free)	3000 / Tape & Reel
NCP163ASN180T1G	1.8 V	KAA			
NCP163ASN250T1G	2.5 V	KAD			
NCP163ASN270T1G	2.7 V	KAL			
NCP163ASN280T1G	2.8 V	KAE			
NCP163ASN300T1G	3.0 V	KAF			
NCP163ASN330T1G	3.3 V	KAG			
NCP163ASN350T1G	3.5 V	KAH			
NCP163ASN500T1G	5.0 V	KAJ			

†For information on tape and reel specifications, including part orientation and tape sizes, please refer to our Tape and Reel Packaging Specifications Brochure, [BRD8011/D](#).

MECHANICAL CASE OUTLINE PACKAGE DIMENSIONS

ON Semiconductor®



SOT-23, 5 Lead CASE 527AH ISSUE A

DATE 09 JUN 2021

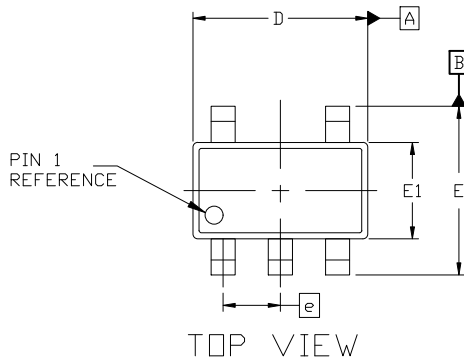

NOTES:

1. DIMENSIONING AND TOLERANCING PER ASME Y14.5M, 1989A
2. CONTROLLING DIMENSION: MILLIMETERS
3. MAXIMUM LEAD THICKNESS INCLUDES LEAD FINISH THICKNESS. MINIMUM LEAD THICKNESS IS THE MINIMUM THICKNESS OF THE BASE MATERIAL.
4. DIMENSIONS D AND E1 DO NOT INCLUDE MOLD FLASH, PROTRUSIONS, OR GATE BURRS. MOLD FLASH, PROTRUSIONS, OR GATE BURRS SHALL NOT EXCEED 0.25 PER SIDE. D AND E1 DIMENSIONS ARE DETERMINED AT DATUM D.
5. DIMENSION 'b' DOES NOT INCLUDE DAMBAR PROTRUSION. ALLOWABLE DAMBAR PROTRUSION SHALL BE 0.08mm TOTAL IN EXCESS OF THE 'b' DIMENSION AT MAXIMUM MATERIAL CONDITION. MINIMUM SPACE BETWEEN PROTRUSION AND AN ADJACENT LEAD SHALL NOT BE LESS THAN 0.07mm.

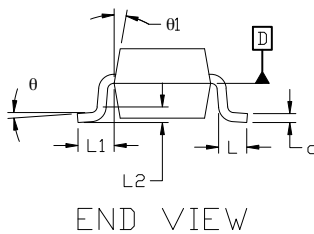

DIM	MILLIMETERS		
	MIN.	NOM.	MAX.
A	0.90	—	1.45
A1	0.00	—	0.15
A2	0.90	1.15	1.30
b	0.30	—	0.50
c	0.08	—	0.22
D	2.90 BSC		
E	2.80 BSC		
E1	1.60 BSC		
e	0.95 BSC		
L	0.30	0.45	0.60
L1	0.60 REF		
L2	0.25 REF		
theta	0°	4°	8°
theta1	0°	10°	15°
theta2	0°	10°	15°

GENERIC MARKING DIAGRAM*

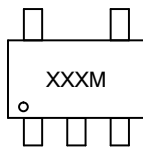

XXX = Specific Device Code
M = Date Code

*This information is generic. Please refer to device data sheet for actual part marking. Pb-Free indicator, "G" or microdot "•", may or may not be present. Some products may not follow the Generic Marking.

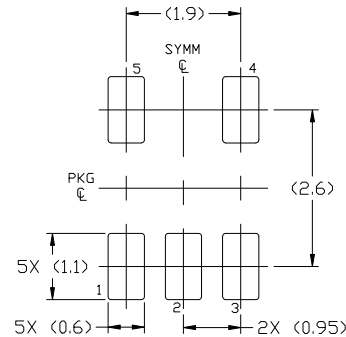

For additional information on our Pb-Free strategy and soldering details, please download the ON Semiconductor Soldering and Mounting Techniques Reference Manual, SOLDERRM/D.

DOCUMENT NUMBER:	98AON34320E	Electronic versions are uncontrolled except when accessed directly from the Document Repository. Printed versions are uncontrolled except when stamped "CONTROLLED COPY" in red.
DESCRIPTION:	SOT-23, 5 LEAD	PAGE 1 OF 1

ON Semiconductor and ON are trademarks of Semiconductor Components Industries, LLC dba ON Semiconductor or its subsidiaries in the United States and/or other countries. ON Semiconductor reserves the right to make changes without further notice to any products herein. ON Semiconductor makes no warranty, representation or guarantee regarding the suitability of its products for any particular purpose, nor does ON Semiconductor assume any liability arising out of the application or use of any product or circuit, and specifically disclaims any and all liability, including without limitation special, consequential or incidental damages. ON Semiconductor does not convey any license under its patent rights nor the rights of others.

MECHANICAL CASE OUTLINE

PACKAGE DIMENSIONS

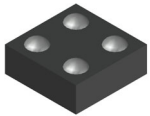

WLCSP4, 0.64x0.64x0.33
CASE 567JZ
ISSUE B

DATE 16 MAY 2022

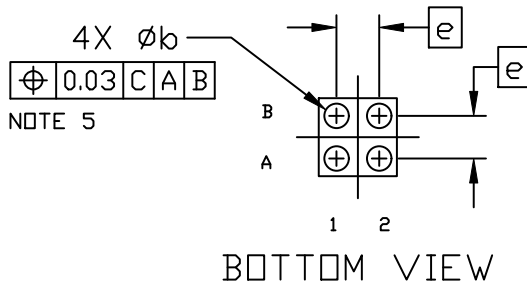
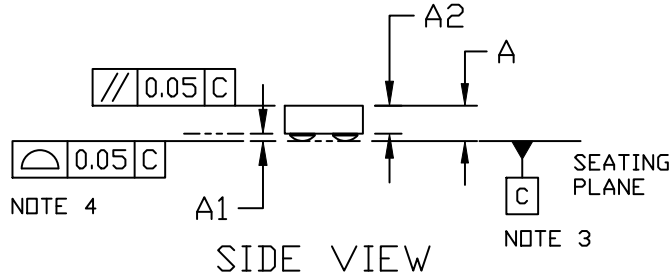
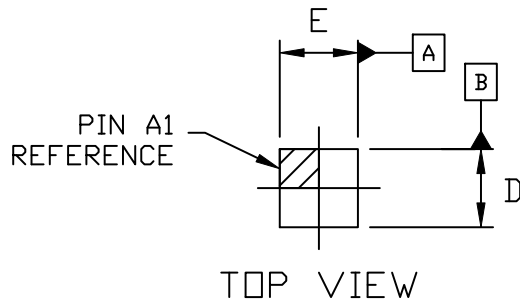

GENERIC MARKING DIAGRAM*



X = Specific Device Code
M = Date Code

*This information is generic. Please refer to device data sheet for actual part marking. Pb-Free indicator, "G" or microdot "▪", may or may not be present. Some products may not follow the Generic Marking.

NOTES:

1. DIMENSIONING AND TOLERANCING PER ASME Y14.5M, 2009.
2. CONTROLLING DIMENSION: MILLIMETERS
3. DATUM C, THE SEATING PLANE, IS DEFINED BY THE SPHERICAL CROWNS OF THE SOLDER BUMPS.
4. COPLANARITY APPLIES TO THE SPHERICAL CROWNS OF THE SOLDER BUMPS.
5. DIMENSION *b* IS MEASURED AT THE MAXIMUM SOLDER BALL DIAMETER PARALLEL TO DATUM C.

DIM	MILLIMETERS		
	MIN.	NOM.	MAX.
A	---	---	0.33
A1	0.04	0.06	0.08
A2	0.23 REF		
<i>b</i>	0.180	0.200	0.220
D	0.610	0.640	0.670
E	0.610	0.640	0.670
<i>e</i>	0.35 BSC		

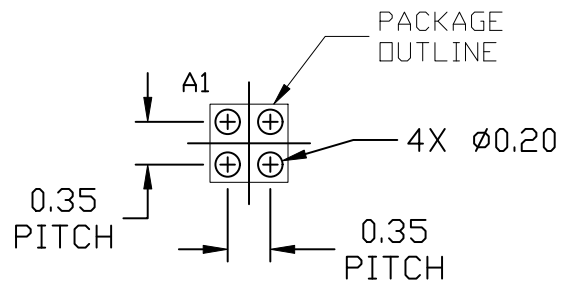

RECOMMENDED MOUNTING FOOTPRINT * (NSMD PAD TYPE)

* For additional information on our Pb-Free strategy and soldering details, please download the ON Semiconductor Soldering and Mounting Techniques Reference Manual, SOLDERRM/D.

DOCUMENT NUMBER:	98AON85781F	Electronic versions are uncontrolled except when accessed directly from the Document Repository. Printed versions are uncontrolled except when stamped "CONTROLLED COPY" in red.
DESCRIPTION:	WLCSP4, 0.64X0.64x0.33	PAGE 1 OF 1

onsemi and ONSEMI are trademarks of Semiconductor Components Industries, LLC dba onsemi or its subsidiaries in the United States and/or other countries. onsemi reserves the right to make changes without further notice to any products herein. onsemi makes no warranty, representation or guarantee regarding the suitability of its products for any particular purpose, nor does onsemi assume any liability arising out of the application or use of any product or circuit, and specifically disclaims any and all liability, including without limitation special, consequential or incidental damages. onsemi does not convey any license under its patent rights nor the rights of others.



SCALE 4:1

WLCSP4, 0.64x0.64
CASE 567KA
ISSUE B

DATE 24 MAR 2020

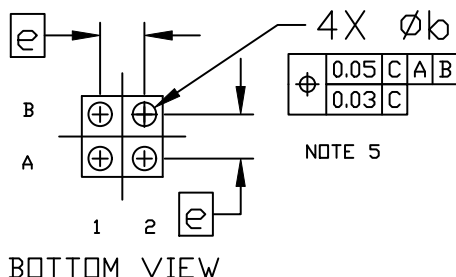
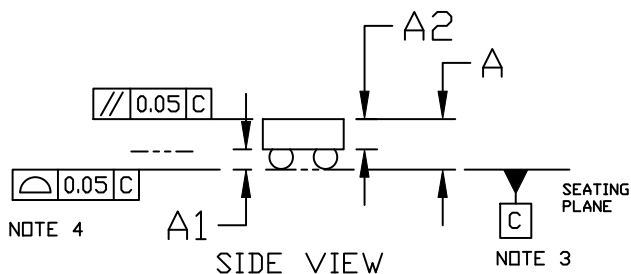
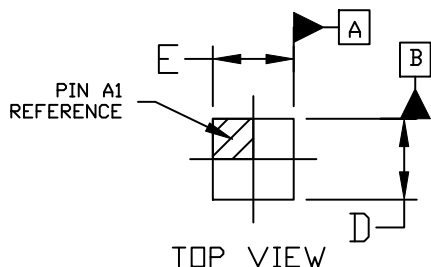

GENERIC MARKING DIAGRAM*



X = Specific Device Code
M = Date Code

This information is generic. Please refer to device data sheet for actual part marking. Pb-Free indicator, "G" or microdot "", may or may not be present. Some products may not follow the Generic Marking.

NOTES:

1. DIMENSIONING AND TOLERANCING PER ASME Y14.5M, 2009.
2. CONTROLLING DIMENSION: MILLIMETERS
3. DATUM C, THE SEATING PLANE, IS DEFINED BY THE SPHERICAL CROWNS OF THE CONTACT BALLS.
4. COPLANARITY APPLIES TO THE SPHERICAL CROWNS OF THE CONTACT BALLS.
5. DIMENSION b IS MEASURED AT THE MAXIMUM CONTACT BALL DIAMETER PARALLEL TO DATUM C.

DIM	MILLIMETERS		
	MIN.	NOM.	MAX.
A	0.355	0.405	0.455
A1	0.13	0.15	0.17
A2	0.255 REF		
b	0.167	0.187	0.207
D	0.610	0.640	0.670
E	0.610	0.640	0.670
e	0.35 BSC		

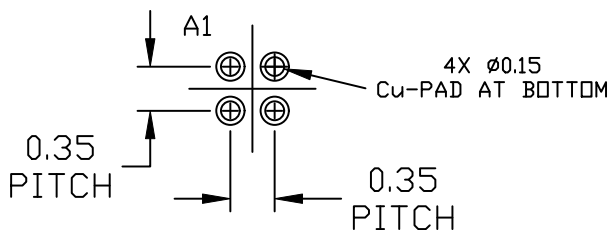

RECOMMENDED MOUNTING FOOTPRINT* (NSMD PAD TYPE)

* For additional information on our Pb-Free strategy and soldering details, please download the ON Semiconductor Soldering and Mounting Techniques Reference Manual, SOLDERRM/D.

DOCUMENT NUMBER:	98AON85783F	Electronic versions are uncontrolled except when accessed directly from the Document Repository. Printed versions are uncontrolled except when stamped "CONTROLLED COPY" in red.
DESCRIPTION:	WLCSP4, 0.64X0.64	PAGE 1 OF 1

ON Semiconductor and are trademarks of Semiconductor Components Industries, LLC dba ON Semiconductor or its subsidiaries in the United States and/or other countries. ON Semiconductor reserves the right to make changes without further notice to any products herein. ON Semiconductor makes no warranty, representation or guarantee regarding the suitability of its products for any particular purpose, nor does ON Semiconductor assume any liability arising out of the application or use of any product or circuit, and specifically disclaims any and all liability, including without limitation special, consequential or incidental damages. ON Semiconductor does not convey any license under its patent rights nor the rights of others.

WLCSP4, 0.64x0.64x0.40
CASE 567XW
ISSUE A

DATE 13 NOV 2019

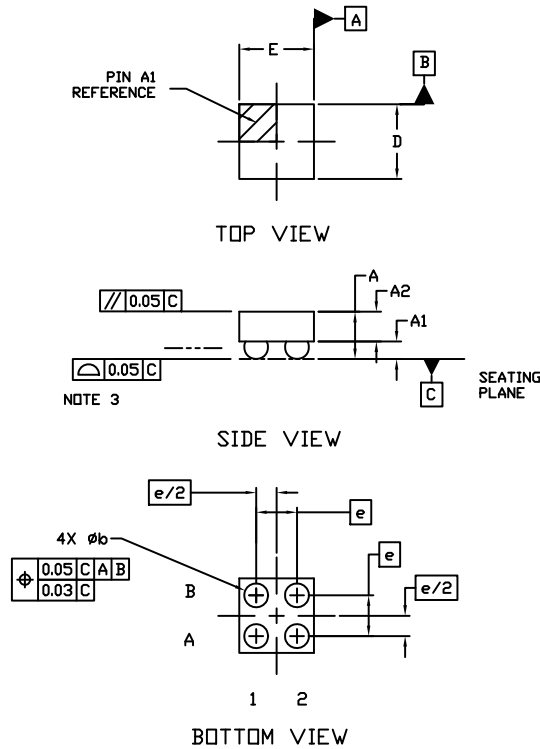

GENERIC MARKING DIAGRAM*



X = Specific Device Code
M = Month

*This information is generic. Please refer to device data sheet for actual part marking. Pb-Free indicator, "G" or microdot "▪", may or may not be present. Some products may not follow the Generic Marking.

NOTES:

1. DIMENSIONING AND TOLERANCING PER ASME Y14.5M, 1994.
2. CONTROLLING DIMENSION: MILLIMETERS
3. COPLANARITY APPLIES TO THE SPHERICAL CROWNS OF THE SOLDER BALLS.
4. DATUM C, THE SEATING PLANE, IS DEFINED BY THE SPHERICAL CROWNS OF THE SOLDER BALLS.
5. DIMENSION b IS MEASURED AT THE MAXIMUM SOLDER BALL DIAMETER PARALLEL TO DATUM C.

DIM	MILLIMETERS		
	MIN.	NOM.	MAX.
A	0.360	0.405	0.450
A1	0.130	0.150	0.170
A2	0.255 REF		
b	0.180	0.210	0.240
D	0.610	0.640	0.670
E	0.610	0.640	0.670
e	0.350 BSC		

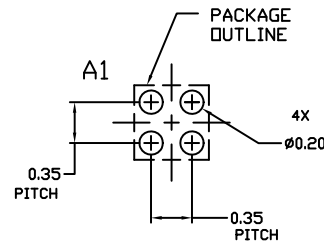

RECOMMENDED MOUNTING FOOTPRINT

- * For additional information on our Pb-Free strategy and soldering details, please download the ON Semiconductor Soldering and Mounting Techniques Reference Manual, SLDERRM/D.

DOCUMENT NUMBER:	98AON08375H	Electronic versions are uncontrolled except when accessed directly from the Document Repository. Printed versions are uncontrolled except when stamped "CONTROLLED COPY" in red.
DESCRIPTION:	WLCSP4, 0.64x0.64x0.40	PAGE 1 OF 1

ON Semiconductor and  are trademarks of Semiconductor Components Industries, LLC dba ON Semiconductor or its subsidiaries in the United States and/or other countries. ON Semiconductor reserves the right to make changes without further notice to any products herein. ON Semiconductor makes no warranty, representation or guarantee regarding the suitability of its products for any particular purpose, nor does ON Semiconductor assume any liability arising out of the application or use of any product or circuit, and specifically disclaims any and all liability, including without limitation special, consequential or incidental damages. ON Semiconductor does not convey any license under its patent rights nor the rights of others.

MECHANICAL CASE OUTLINE PACKAGE DIMENSIONS



XDFN4 1.0x1.0, 0.65P
CASE 711AJ
ISSUE C

DATE 08 MAR 2022



NOTES:

1. DIMENSIONING AND TOLERANCING PER ASME Y14.5M, 1994.
2. CONTROLLING DIMENSION: MILLIMETERS
3. DIMENSION *b* APPLIES TO THE PLATED TERMINALS AND IS MEASURED BETWEEN 0.15 AND 0.20 FROM THE TERMINAL TIPS.
4. COPLANARITY APPLIES TO THE EXPOSED PAD AS WELL AS THE TERMINALS.

DIM	MILLIMETERS		
	MIN	NOM	MAX
A	0.33	0.38	0.43
A1	0.00	---	0.05
A3	0.10 REF		
<i>b</i>	0.15	0.20	0.25
<i>b</i> 2	0.02	0.07	0.12
D	0.90	1.00	1.10
D2	0.43	0.48	0.53
E	0.90	1.00	1.10
<i>e</i>	0.65 BSC		
L	0.20		0.30
L2	0.07		0.17

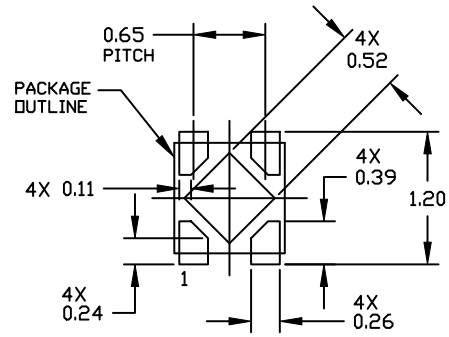
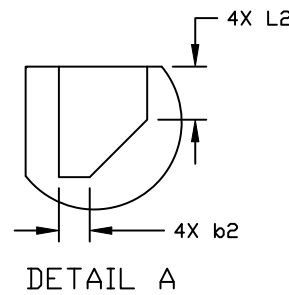
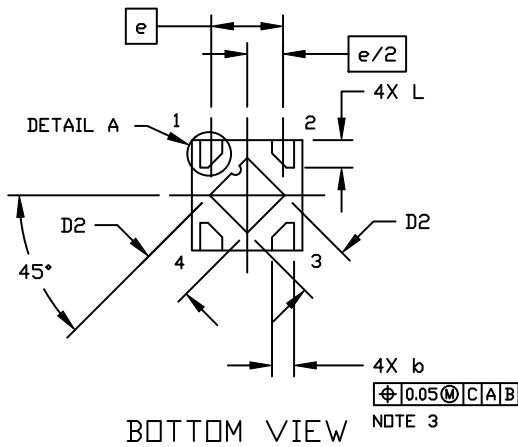

**RECOMMENDED
MOUNTING FOOTPRINT**

* FOR ADDITIONAL INFORMATION ON OUR Pb-FREE STRATEGY AND SOLDERING DETAILS, PLEASE DOWNLOAD THE ONSEMI SOLDERING AND MOUNT TECHNIQUES REFERENCE MANUAL, SOLDERRM/D

GENERIC MARKING DIAGRAM*

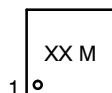

XX = Specific Device Code
M = Date Code

*This information is generic. Please refer to device data sheet for actual part marking. Pb-Free indicator, "G" or microdot "•", may or may not be present. Some products may not follow the Generic Marking.

DOCUMENT NUMBER:	98AON67179E	Electronic versions are uncontrolled except when accessed directly from the Document Repository. Printed versions are uncontrolled except when stamped "CONTROLLED COPY" in red.
DESCRIPTION:	XDFN4, 1.0X1.0, 0.65P	PAGE 1 OF 1

onsemi and ONSEMI are trademarks of Semiconductor Components Industries, LLC dba onsemi or its subsidiaries in the United States and/or other countries. onsemi reserves the right to make changes without further notice to any products herein. onsemi makes no warranty, representation or guarantee regarding the suitability of its products for any particular purpose, nor does onsemi assume any liability arising out of the application or use of any product or circuit, and specifically disclaims any and all liability, including without limitation special, consequential or incidental damages. onsemi does not convey any license under its patent rights nor the rights of others.

onsemi, **Onsemi**, and other names, marks, and brands are registered and/or common law trademarks of Semiconductor Components Industries, LLC dba "**onsemi**" or its affiliates and/or subsidiaries in the United States and/or other countries. **onsemi** owns the rights to a number of patents, trademarks, copyrights, trade secrets, and other intellectual property. A listing of **onsemi**'s product/patent coverage may be accessed at www.onsemi.com/site/pdf/Patent-Marking.pdf. **onsemi** reserves the right to make changes at any time to any products or information herein, without notice. The information herein is provided "as-is" and **onsemi** makes no warranty, representation or guarantee regarding the accuracy of the information, product features, availability, functionality, or suitability of its products for any particular purpose, nor does **onsemi** assume any liability arising out of the application or use of any product or circuit, and specifically disclaims any and all liability, including without limitation special, consequential or incidental damages. Buyer is responsible for its products and applications using **onsemi** products, including compliance with all laws, regulations and safety requirements or standards, regardless of any support or applications information provided by **onsemi**. "Typical" parameters which may be provided in **onsemi** data sheets and/or specifications can and do vary in different applications and actual performance may vary over time. All operating parameters, including "Typicals" must be validated for each customer application by customer's technical experts. **onsemi** does not convey any license under any of its intellectual property rights nor the rights of others. **onsemi** products are not designed, intended, or authorized for use as a critical component in life support systems or any FDA Class 3 medical devices or medical devices with a same or similar classification in a foreign jurisdiction or any devices intended for implantation in the human body. Should Buyer purchase or use **onsemi** products for any such unintended or unauthorized application, Buyer shall indemnify and hold **onsemi** and its officers, employees, subsidiaries, affiliates, and distributors harmless against all claims, costs, damages, and expenses, and reasonable attorney fees arising out of, directly or indirectly, any claim of personal injury or death associated with such unintended or unauthorized use, even if such claim alleges that **onsemi** was negligent regarding the design or manufacture of the part. **onsemi** is an Equal Opportunity/Affirmative Action Employer. This literature is subject to all applicable copyright laws and is not for resale in any manner.

ADDITIONAL INFORMATION

TECHNICAL PUBLICATIONS:

Technical Library: www.onsemi.com/design/resources/technical-documentation
onsemi Website: www.onsemi.com

ONLINE SUPPORT: www.onsemi.com/support

For additional information, please contact your local Sales Representative at www.onsemi.com/support/sales

