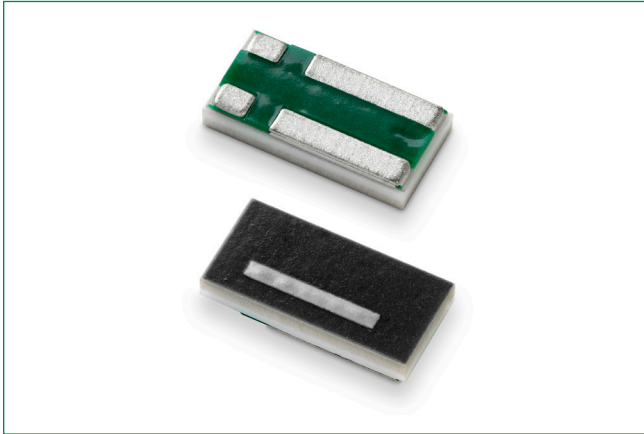

Four-Terminal Surface Mount Resistor

L4CA/C Series

HF **RoHS** **Pb**

Description

Littelfuse L4CA/C Series Kelvin sensing, low resistance, high power chip resistors exhibit excellent performance in resistance, noise performance, surface heat distribution, and have a lower surface temperature.

Features

- Resistance range down to 0.5 mΩ
- Separate voltage sensing terminals
- Ceramic substrate

Benefits

- Small size
- High voltage

Application

- Power management
- Low ESL

Additional Information

Resources

Accessories

Samples

Four-Terminal Surface Mount Resistor

L4CA/C Series

Electrical Specifications

LF Seires	Part Number	Size		Resistance		Power (W)	TCR (ppm/°C)	Standard Package Qty
		Inch	mm	Ro (mΩ)	Rt (%)			
L4CC	L4CC0306RLR001FNR	0306	816	1	±1.0%	0.33	±100	5000
L4CC	L4CC0306RLR002FNR	0306	816	2	±1.0%	0.33	±100	5000
L4CC	L4CC0306QLR005FNR	0306	816	5	±1.0%	0.33	±50	5000
L4CC	L4CC0306QLR006FNR	0306	816	6	±1.0%	0.33	±50	5000
L4CC	L4CC0306QLR007FNR	0306	816	7	±1.0%	0.33	±50	5000
L4CC	L4CC0306QLR008FNR	0306	816	8	±1.0%	0.33	±50	5000
L4CC	L4CC0306QLR009FNR	0306	816	9	±1.0%	0.33	±50	5000
L4CC	L4CC0306QLR010FNR	0306	816	10	±1.0%	0.33	±50	5000
L4CC	L4CC0306QLR011FNR	0306	816	11	±1.0%	0.33	±50	5000
L4CC	L4CC0306QLR012FNR	0306	816	12	±1.0%	0.33	±50	5000
L4CC	L4CC0306QLR013FNR	0306	816	13	±1.0%	0.33	±50	5000
L4CC	L4CC0306QLR014FNR	0306	816	14	±1.0%	0.33	±50	5000
L4CC	L4CC0306QLR015FNR	0306	816	15	±1.0%	0.33	±50	5000
L4CC	L4CC0306QLR016FNR	0306	816	16	±1.0%	0.33	±50	5000
L4CC	L4CC0306QLR018FNR	0306	816	18	±1.0%	0.33	±50	5000
L4CC	L4CC0306QLR020FNR	0306	816	20	±1.0%	0.33	±50	5000
L4CC	L4CC0306QLR021FNR	0306	816	21	±1.0%	0.33	±50	5000
L4CC	L4CC0306QLR022FNR	0306	816	22	±1.0%	0.33	±50	5000
L4CC	L4CC0306QLR024FNR	0306	816	24	±1.0%	0.33	±50	5000
L4CC	L4CC0306QLR035FNR	0306	816	35	±1.0%	0.33	±50	5000
L4CC	L4CC0306QLR050FNR	0306	816	50	±1.0%	0.33	±50	5000
L4CA	L4CA0612L0M50FNR	0612	1632	0.5	±1.0%	1	±150	5000
L4CA	L4CA0612LR003FNR	0612	1632	3	±1.0%	1	±100	5000
L4CA	L4CA0612LR004FNR	0612	1632	4	±1.0%	1	±100	5000
L4CA	L4CA0612LR005FNR	0612	1632	5	±1.0%	1	±50	5000
L4CA	L4CA0612LR006FNR	0612	1632	6	±1.0%	1	±50	5000
L4CA	L4CA0612LR007FNR	0612	1632	7	±1.0%	1	±50	5000
L4CA	L4CA0612LR008FNR	0612	1632	8	±1.0%	1	±50	5000
L4CA	L4CA0612LR009FNR	0612	1632	9	±1.0%	1	±50	5000
L4CA	L4CA0612LR010FNR	0612	1632	10	±1.0%	1	±50	5000
L4CA	L4CA0612LR011FNR	0612	1632	11	±1.0%	1	±50	5000
L4CA	L4CA0612LR012FNR	0612	1632	12	±1.0%	1	±50	5000
L4CA	L4CA0612LR013FNR	0612	1632	13	±1.0%	1	±50	5000
L4CA	L4CA0612LR014FNR	0612	1632	14	±1.0%	1	±50	5000
L4CA	L4CA0612LR015FNR	0612	1632	15	±1.0%	1	±50	5000
L4CA	L4CA0612LR016FNR	0612	1632	16	±1.0%	1	±50	5000
L4CA	L4CA0612LR018FNR	0612	1632	18	±1.0%	1	±50	5000
L4CA	L4CA0612LR020FNR	0612	1632	20	±1.0%	1	±50	5000
L4CA	L4CA0612LR021FNR	0612	1632	21	±1.0%	1	±50	5000
L4CA	L4CA0612LR022FNR	0612	1632	22	±1.0%	1	±50	5000
L4CA	L4CA0612LR024FNR	0612	1632	24	±1.0%	1	±50	5000
L4CA	L4CA0612LR025FNR	0612	1632	25	±1.0%	1	±50	5000

Note: Resistors are available in steps of 1 mΩ/m. Ratings not indicated in the above table may be available on request.

Four-Terminal Surface Mount Resistor

L4CA/C Series

Temperature De-rating Curve

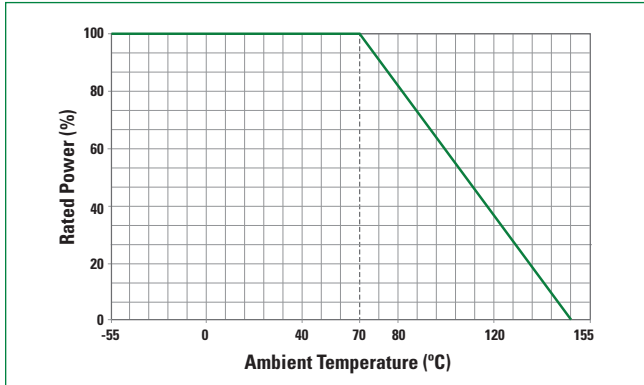

Storage / Environment Conditions

Products should be stored under the following environmental conditions.

Temperature:	+5 to +35 °C
Humidity:	45 to 85% relative humidity
Moisture Sensitivity	Level: 1, J-STD-020

Do not keep products in environments where they may be subject to particulate contamination or harmful gases such as sulfuric acid or hydrogen chloride as it may cause oxidization on electrodes, resulting poor solderability.

Products should be stored in a space that does not expose to high temperatures, vibration, or direct sunlight.

Products should be stored in the original airtight packaging until use.

Soldering Parameters—Wave Soldering

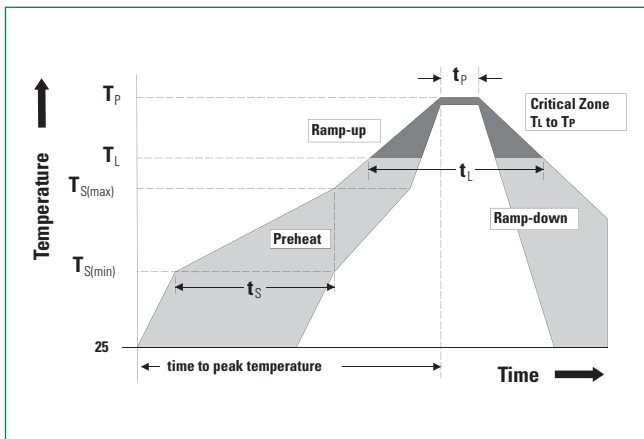

Profile Feature	Pb-Free Assembly
Average Ramp-Up Rate ($T_{S(max)}$ to T_p)	3 °C / second max
Preheat	
Temperature Minimum ($T_{S(min)}$)	150 °C
Temperature Maximum ($T_{S(max)}$)	200 °C
Time ($T_{S(min)}$ to $T_{S(max)}$)	60–180 seconds
Time maintained above	
Temperature Minimum (T_L)	217 °C
Time (t_L)	60–150 seconds
Peak Temperature (T_p)	260 +0 °C
Time within 5 °C of Actual Peak Temperature (t_p)	20–40 seconds
Ramp-Down Rate	6 °C / second Maximum
Time 25 °C to Peak Temperature	8 minutes Maximum

Four-Terminal Surface Mount Resistor

L4CA/C Series

Reliability Specifications

Test	Procedure	Specifications
Resistance Data	Resistance data at 25 °C	Must meet datasheet requirements
TCR Data	Tested at 25 °C and 125 °C , $TCR = (R_b - R_a) / R_a \times 1 / (T_b - T_a) \times 10^6$	Must meet datasheet requirements
Dimensional Data	Measure all dimensions specified in datasheet	Must meet datasheet requirements
Short Time Overload JIS-C-5201, 4.13	Applied voltage: 2.5X rated power. Test duration: 5 seconds	±1.0%
Load Life (1) JIS-C-5201-1, 4.25	Test Temperature: 70 °C ± 3 °C, Applied voltage: rated voltage Test period: 1,000 hours with power cycling as follows: 90 min. power ON / 30 min. power OFF	±1.0%
Moisture Resistance (1) JIS-C-5201-1, 4.24	Test Condition: 40 °C ± 3 °C / 90–95% RH Test period: 1,000 hours	±1.0%
Temperature Cycle (1) (Thermal Shock) JESD22-A-104	Repeat 1,000 cycles as follows: -55 ± 3 °C (30 min.) / +155 ± 3 °C (30 min.) Transition time of 1 minute maximum	±1.0%
Resistance To Solder Heat #1 J-STD-020	One reflow cycle according to JEDEC J-STD-020, cool down then parts are immersed into a molten solder bath with a temperature of 260 °C for a period of 10 ± 1 seconds.	Part must meet initial specifications following testing
Resistance To Solder Heat #2 J-STD-020	Per component MSL classification per J-STD-020, 3 reflow cycles	±1.0%
High Temperature Exposure (1) MIL-STD-202, Method 108, Condition D	Test Temperature: Maximum rated operational temperature Test period: 1,000 hours , No electrical load	±1.0%
HAST (1) (Highly Accelerated, Stress Test - Autoclave)	Test Temperature: 121 °C ± 2 °C Test Pressure: 30 PSIA, Test period: 48 hours , No electrical load	±1.0%
Terminal Strength AEC-Q200-006	Test Force: 17.7N Duration: 60 ± 1 seconds, Parts must be soldered onto a PCB to perform test	±0.5%
Vibration (1) MIL-STD-202, Method 204, Condition B	Frequency: 10 - 2,000 Hz Acceleration: 15 ± 1.5 gs Test Duration: 20 mins / 12 Cycles	±1.0%
Mechanical Shock (1) MIL-STD-202, Method 213, Condition A	Force: 50 ± 5 gs Test Duration: 11 ± 1 milliseconds	±1.0%
Solderability MIL-STD-202, Method 208H, Category 3	Dipped into molten solder for 3 ± 1 seconds at 245 ± 5 °C Flux activity type R0	New solder coverage of 90% minimum
Pre-Conditioning	Per component MSL classification per J-STD-020, 3 reflow cycles	N / A

Four-Terminal Surface Mount Resistor

L4CA/C Series

Dimensions

All dimensions in mm

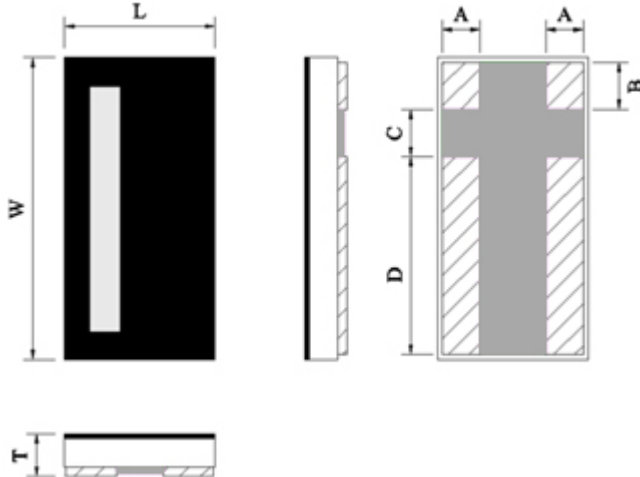

Part Number	W	L	T	D	C	B	A
L4CA0612	3.20±0.20	1.55±0.20)	0.50±0.20	2.16±0.20	0.50±0.20	0.46±0.20	0.41±0.20
L4CC0306	1.60±0.20	0.80±0.15	0.55±0.10	0.93±0.20	0.40±0.10	0.23±0.10	0.18±0.10

Recommended Land Pattern

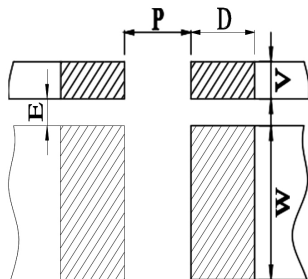

Part Number	P	W	D	V	E	Loading
L4CA0612	0.762 mm	2.29 mm	1.014 mm	0.762 mm	0.381 mm	1.0 W
L4CC0306	0.35 mm	1.30 mm	0.40 mm	0.40 mm	0.20 mm	0.33 W

Packaging

Part Number	Halogen Free	Packaging Option	Quantity	Quantity & Packaging Codes
L4CA0612	Yes	Tape and Reel	5000	NR
L4CC0306	Yes	Tape and Reel	5000	NR

Four-Terminal Surface Mount Resistor

L4CA/C Series

Part Numbering System

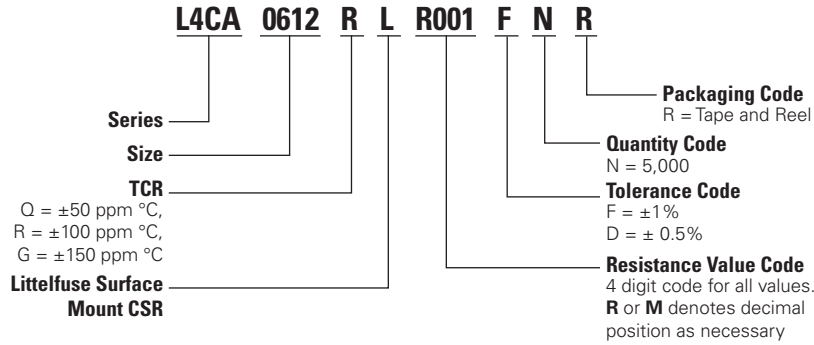

Tape and Reel Specifications

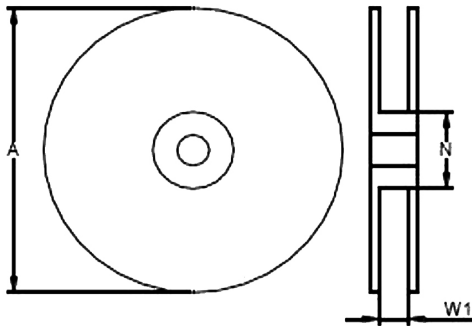

Part Number	A±5 (mm)	N±2 (mm)	W1±1 (mm)
L4CA0612	178	60	9.0

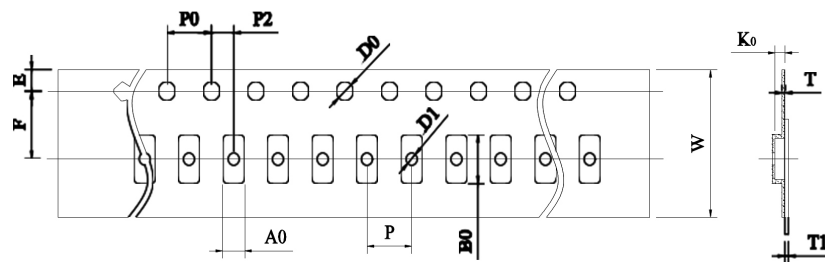

Part Number	W	P0	P	P2	A0	B0	D0	F	E	T	T1	K0
L4CA0612	8.00±0.30	4.00±0.10	4.00±0.10	2.00±0.10	1.90±0.20	3.50±0.20	1.50±0.10	3.50±0.10	1.75±0.10	0.20±0.10	Max. 0.1	0.85±0.20
L4CC0306	8.00±0.30	4.00±0.10	4.00±0.10	2.00±0.10	0.98 ± 0.20	1.85 ± 0.20	1.50±0.10	3.50±0.10	1.75±0.10	0.75 ± 0.20		

Disclaimer Notice - Information furnished is believed to be accurate and reliable. However, users should independently evaluate the suitability of and test each product selected for their own applications. Littelfuse products are not designed for, and may not be used in, all applications. Read complete Disclaimer Notice at <http://www.littelfuse.com/disclaimer-electronics>.