

3950X SERIES
3.50mm HEADERS

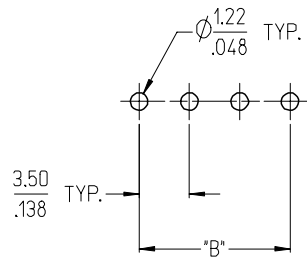

3952X & 3954X SERIES
5.00mm HEADERS
5.00mm 10 AMP FIXED

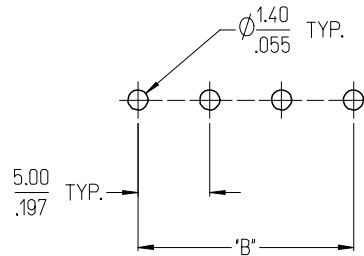

3953X SERIES
5.08mm HEADERS

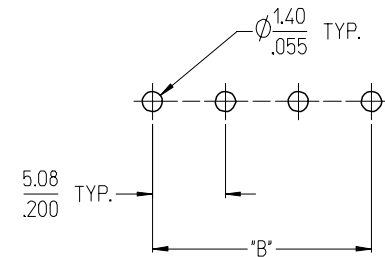

3951X SERIES
3.81mm HEADERS

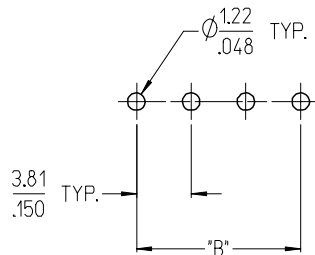

3954X SERIES
5.00mm 15 AMP FIXED

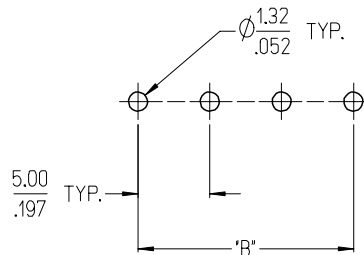

3954X SERIES
5.08mm 15 AMP FIXED

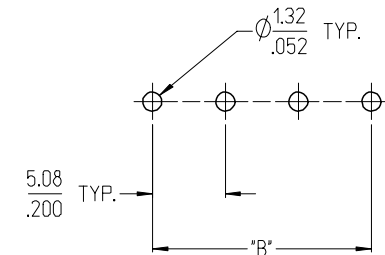

NOTES:

- REFER TO INDIVIDUAL PRODUCT SALES DRAWINGS FOR "B" DIMENSION.
- DOES NOT APPLY TO DUAL LEVEL HEADERS, SERIES 39528 AND 39538.
- TYP. = TYPICAL.

INITIAL RELEASE	EC NO: ETC2007-0096
DRWN: CLYORK	2006/10/02
CHKD: JMACNEIL	2006/10/04
APPR: JMACNEIL	2006/10/04
REV	DESCRIPTION
A	

QUALITY SYMBOLS
▽=0
▽=0

GENERAL TOLERANCES (UNLESS SPECIFIED)	
	mm
4 PLACES	± .005
3 PLACES	± .005
2 PLACES	± 0.13
1 PLACE	± 0.3
ANGULAR ± 2 °	
DRAFT WHERE APPLICABLE MUST REMAIN WITHIN DIMENSIONS	

DIMENSION STYLE	
MM/IN	
DRAWN BY	DATE
C. YORK	2006/08/25
CHECKED BY	DATE
J. MACNEIL	2006/08/25
APPROVED BY	DATE
J. MACNEIL	2006/08/25
MATERIAL NO.	
--	

SCALE	DESIGN UNITS	THIRD ANGLE PROJECTION
3:1	INCH	
TITLE		
RECOMMENDED PCB LAYOUT FOR ESE TERMINAL BLOCKS		
MOLEX INCORPORATED		
DOCUMENT NO.	SHEET NO.	
SD-39501-002	1 OF 1	
THIS DRAWING CONTAINS INFORMATION THAT IS PROPRIETARY TO MOLEX INCORPORATED AND SHOULD NOT BE USED WITHOUT WRITTEN PERMISSION		

10 9 8 7 6 5 4 3 2 1

F
E
D
C
B
A

F
E
D
C
B
A

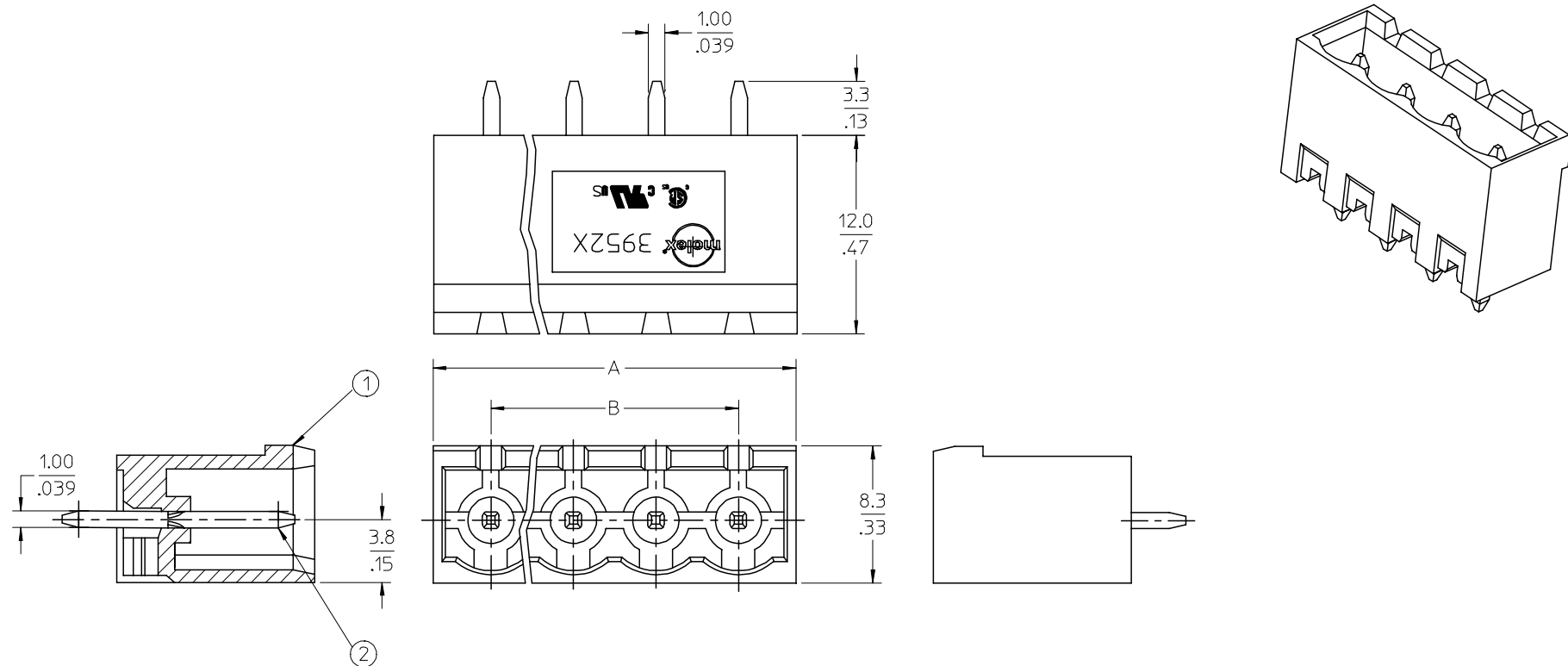

SPECIFICATIONS:

1. Material:
 - (1). Body: PA66
 - (2). Pin: Brass
2. Wire range: N/A
3. Electrical rating: 300V, 15A.
4. Wire strip length: N/A
5. Operating temperature: -40C to +105C.
6. Max torque: N/A
7. Insulation resistance: DC 500V, 500M.
8. Dielectric withstand: AC 2500V for 1 minute.
9. Breakdown voltage: 4000V.
10. A = (N x P) + 2.0mm
11. B = (N - 1) x P
12. P (PITCH) = 5.0mm (.197").
13. N = Number of positions available 2 through 24.

ENTER DESCRIPTION EC NO: NEO2006-0310 DRWNL: LROTHAUS 2006/01/09 CHKD: CYORK 2006/01/09 APPR: JPAMLIK 2006/01/10	DESCRIPTION REV	QUALITY SYMBOLS ▽=0 ▽=0	GENERAL TOLERANCES (UNLESS SPECIFIED)		DIMENSION STYLE	SCALE	DESIGN UNITS	THIRD ANGLE PROJECTION	
					MM/IN	4:1	INCH		
			4 PLACES ± --- ±.0015	DRAWN BY	DATE	TITLE 5.0MM, EURO HEADER, VERTICAL			
			3 PLACES ±0.038 ±.005	LROTHAUS	12/6/05				
			2 PLACES ±0.13 ±.01	CHECKED BY	DATE	MOLEX INCORPORATED			
			1 PLACE ±0.3 ±---	C. YORK	01/06/06				
			ANGULAR ± 2 °	APPROVED BY	DATE	DOCUMENT NO. SD-39521-002			
			DRAFT WHERE APPLICABLE MUST REMAIN WITHIN DIMENSIONS	MATERIAL NO.	DATE	SHEET NO. 1 OF 1			
				SEE CHART					
				SIZE		THIS DRAWING CONTAINS INFORMATION THAT IS PROPRIETARY TO MOLEX INCORPORATED AND SHOULD NOT BE USED WITHOUT WRITTEN PERMISSION			
				B					

9 8 7 6 5 4 3 2 1

10 9 8 7 6 5 4 3 2 1

Description	Circuit size	Material Numbers											Dimensional Information				
		Black						Green									
		100% Tin			30 u" Gold			100% Tin			30 u" Gold		Dim A		Dim B		
		Printing Options			Printing Options			Printing Options			Printing Options						
None	10AV	11AV	None	10AV	11AV	None	10AV	11AV	None	10AV	11AV	mm	inch	mm	inch		
5.0mm, Euro Header, Vertical	2	395211002	395211302	395211402	395211502	395211802	395211902	395216002	395216302	395216402	395216502	395216802	395216902	12.00	0.472	5.00	0.197
5.0mm, Euro Header, Vertical	3	395211003	395211303	395211403	395211503	395211803	395211903	395216003	395216303	395216403	395216503	395216803	395216903	17.00	0.669	10.00	0.394
5.0mm, Euro Header, Vertical	4	395211004	395211304	395211404	395211504	395211804	395211904	395216004	395216304	395216404	395216504	395216804	395216904	22.00	0.866	15.00	0.591
5.0mm, Euro Header, Vertical	5	395211005	395211305	395211405	395211505	395211805	395211905	395216005	395216305	395216405	395216505	395216805	395216905	27.00	1.063	20.00	0.787
5.0mm, Euro Header, Vertical	6	395211006	395211306	395211406	395211506	395211806	395211906	395216006	395216306	395216406	395216506	395216806	395216906	32.00	1.260	25.00	0.984
5.0mm, Euro Header, Vertical	7	395211007	395211307	395211407	395211507	395211807	395211907	395216007	395216307	395216407	395216507	395216807	395216907	37.00	1.457	30.00	1.181
5.0mm, Euro Header, Vertical	8	395211008	395211308	395211408	395211508	395211808	395211908	395216008	395216308	395216408	395216508	395216808	395216908	42.00	1.654	35.00	1.378
5.0mm, Euro Header, Vertical	9	395211009	395211309	395211409	395211509	395211809	395211909	395216009	395216309	395216409	395216509	395216809	395216909	47.00	1.850	40.00	1.575
5.0mm, Euro Header, Vertical	10	395211010	395211310	395211410	395211510	395211810	395211910	395216010	395216310	395216410	395216510	395216810	395216910	52.00	2.047	45.00	1.772
5.0mm, Euro Header, Vertical	11	395211011	395211311	395211411	395211511	395211811	395211911	395216011	395216311	395216411	395216511	395216811	395216911	57.00	2.244	50.00	1.969
5.0mm, Euro Header, Vertical	12	395211012	395211312	395211412	395211512	395211812	395211912	395216012	395216312	395216412	395216512	395216812	395216912	62.00	2.441	55.00	2.165
5.0mm, Euro Header, Vertical	13	395211013	395211313	395211413	395211513	395211813	395211913	395216013	395216313	395216413	395216513	395216813	395216913	67.00	2.638	60.00	2.362
5.0mm, Euro Header, Vertical	14	395211014	395211314	395211414	395211514	395211814	395211914	395216014	395216314	395216414	395216514	395216814	395216914	72.00	2.835	65.00	2.559
5.0mm, Euro Header, Vertical	15	395211015	395211315	395211415	395211515	395211815	395211915	395216015	395216315	395216415	395216515	395216815	395216915	77.00	3.031	70.00	2.756
5.0mm, Euro Header, Vertical	16	395211016	395211316	395211416	395211516	395211816	395211916	395216016	395216316	395216416	395216516	395216816	395216916	82.00	3.228	75.00	2.953
5.0mm, Euro Header, Vertical	17	395211017	395211317	395211417	395211517	395211817	395211917	395216017	395216317	395216417	395216517	395216817	395216917	87.00	3.425	80.00	3.150
5.0mm, Euro Header, Vertical	18	395211018	395211318	395211418	395211518	395211818	395211918	395216018	395216318	395216418	395216518	395216818	395216918	92.00	3.622	85.00	3.346
5.0mm, Euro Header, Vertical	19	395211019	395211319	395211419	395211519	395211819	395211919	395216019	395216319	395216419	395216519	395216819	395216919	97.00	3.819	90.00	3.543
5.0mm, Euro Header, Vertical	20	395211020	395211320	395211420	395211520	395211820	395211920	395216020	395216320	395216420	395216520	395216820	395216920	102.00	4.016	95.00	3.740
5.0mm, Euro Header, Vertical	21	395211021	395211321	395211421	395211521	395211821	395211921	395216021	395216321	395216421	395216521	395216821	395216921	107.00	4.213	100.00	3.937
5.0mm, Euro Header, Vertical	22	395211022	395211322	395211422	395211522	395211822	395211922	395216022	395216322	395216422	395216522	395216822	395216922	112.00	4.409	105.00	4.134
5.0mm, Euro Header, Vertical	23	395211023	395211323	395211423	395211523	395211823	395211923	395216023	395216323	395216423	395216523	395216823	395216923	117.00	4.606	110.00	4.331
5.0mm, Euro Header, Vertical	24	395211024	395211324	395211424	395211524	395211824	395211924	395216024	395216324	395216424	395216524	395216824	395216924	122.00	4.803	115.00	4.528

SEE SHEET 1 EC NO: NEC02006-0310 DRWNL: LROTHAUS 2006/01/09 CHKDC: CYORK 2006/01/09 APPR: J.P.A.M.L.I.C.K 2006/01/10 A	QUALITY SYMBOLS 	GENERAL TOLERANCES (UNLESS SPECIFIED)		DIMENSION STYLE		SCALE	DESIGN UNITS	THIRD ANGLE PROJECTION
				MM/IN		4:1	INCH	
				DRAWN BY DATE		TITLE		
				CHECKED BY DATE		MOLEX INCORPORATED		
		APPROVED BY DATE		MATERIAL NO.		DOCUMENT NO.		SHEET NO.
		ANGULAR ± 2 °		SEE CHART		SD-39521-002		2 OF 2
		DRAFT WHERE APPLICABLE MUST REMAIN WITHIN DIMENSIONS						
THIS DRAWING CONTAINS INFORMATION THAT IS PROPRIETARY TO MOLEX INCORPORATED AND SHOULD NOT BE USED WITHOUT WRITTEN PERMISSION								

9 8 7 6 5 4 3 2 1