

# 7000 Series Miniature Rocker & Lever Handle Switches

## Features/Benefits

- Multi-pole and multi-position
- Wide variety of actuator and termination options
- Epoxy terminal-seal compatible with bottom wash cleaning
- RoHS compliant



Models Available

## Typical Applications

- Telecommunications
- Instrumentation
- Medical equipment



## Specifications

**CONTACT RATING:** B contact material: 0.4 VA max. @ 20 V AC or DC max. Q contact material: 5 AMPS @ 120 V AC or 28 V DC; 2 AMPS @ 250 V AC. See page H-21 for additional ratings.

**ELECTRICAL LIFE:** 7X01 and UX1 models: 100,000 make-and-break cycles at full load. All other models: 40,000 cycles.

**CONTACT RESISTANCE:** Below 10 m Ω typ. initial @ 2-4 V DC, 100 mA, for both silver and gold plated contacts.

**INSULATION RESISTANCE:** 10<sup>9</sup> Ω min.

**DIELECTRIC STRENGTH:** 1000 Vrms min. @ sea level.

**OPERATING TEMPERATURE:** -30°C to 85°C.

**SOLDERABILITY:** Per MIL-STD-202F method 208D, or EIA RS-186E method 9 (1 hour steam aging).

**NOTE:** Any models supplied with S, P, R, Q, B or G contact material are RoHS compliant.

**NOTE:** Specifications and materials listed above are for switches with standard options. For information on specific and custom switches, consult Customer Service Center.

## Materials

**CASE:** Glass filled nylon 6/6, flame retardant, heat stabilized, or diallyl phthalate (DAP) (UL 94V-0).

**ACTUATOR:** Nylon, black.

**FRAME (FRONT MOUNT):** Nylon, black.

**FRAME (REAR MOUNT):** Spring steel, black.

**BUSHING:** Brass or zinc, nickel plated.

**HOUSING:** Stainless steel.

**SWITCH SUPPORT:** Brass or steel, matte-tin plated.

**END CONTACTS:** B contact material: Copper alloy, with gold plate over nickel plate. Q contact material: Coin silver, silver plated. See page G-21 for additional contact materials.

**CENTER CONTACTS & ALL TERMINALS:** B contact material: Copper alloy, with gold plate over nickel plate. Q contact material: Copper alloy, silver plated. See page G-21 for additional contact materials.

**TERMINAL SEAL:** Epoxy. Refer to Soldering and Cleaning in Technical Data Section

**HARDWARE:** Mounting nuts & screws: Brass. Lockwasher: Stainless steel. Standoff: Nylon standard.

## Build-A-Switch

To order, simply select desired option from each category and place in the appropriate box. Available options are shown and described on pages G-5 through G-25. For additional options not shown in catalog, consult Customer Service Center. All models have epoxy terminal seal and are compatible with all "bottom-wash" PCB cleaning methods.



### Switch Function

- 7101 SP On-None-On
- 7103 SP On-Off-On
- 7105 SP Mom.-Off-Mom.
- 7107 SP On-Off-Mom.
- 7108 SP On-None-Mom.
- 7109 SP None-On-Mom.
- 7201 DP On-None-On
- 7203 DP On-Off-On
- 7205 DP Mom.-Off-Mom.
- 7207 DP On-Off-Mom.
- 7208 DP On-None-Mom.
- 7211 DP On-On-On
- 7213 DP On-On-Mom.
- 7215 DP Mom.-On-Mom.
- 7301 3P On-None-On
- 7303 3P On-Off-On
- 7401 4P On-None-On
- 7405 4P Mom.-Off-Mom.
- 7411 4P On-On-On

**Note:** UL/CSA models available, see pages H-5 and H-6.

### Actuator

- J1 .531" long rocker
- J2 Lever
- J3 .906" long rocker
- J8 .699" long rocker
- J10 1.318" long rocker
- J11 Rocker with frame
- J15 Rocker, snap-in
- J16 Rocker with frame, snap-in
- J19 Rocker with frame
- J21 Lever with frame
- J25 Lever, snap-in
- J26 Lever with frame, snap-in
- J37 Rocker with frame
- J50 Rocker
- J51 Rocker with frame
- J52 Rocker with frame for LED, snap-in
- J60 Lever
- J61 Lever with frame, snap-in
- J62 Lever with frame for LED, snap-in
- J90 Lever
- J91 Lever with frame, snap-in

### Terminations

- A Right angle, PC thru-hole
- AV2 Vertical right angle, PC thru-hole
- C PC Thru-hole
- Z Solder lug
- A3 Right angle, snap-in, PC thru-hole
- AV3 Vertical right angle, snap-in, PC thru-hole
- AW3 Right angle, extended, PC thru-hole
- V2 .555" high, V-bracket
- V3 .460" high, V-bracket
- V4 .630" high, V-bracket
- V5 Vertical right angle, PC thru-hole
- V6 .460" high, V-bracket
- V7 .630" high, V-bracket
- V8 .953" high, V-bracket
- V9 1.150" high, V-bracket
- V31 .460" high, V-bracket, snap-in
- V51 Vertical right angle, snap-in
- V61 .460" high, V-bracket, snap-in
- W .750" long, wire wrap
- W3 .425" long, wire wrap
- W5 1.305" long, wire wrap
- Z3 Quick connect

### Contact Material

- B Gold
- P Gold, matte tin
- Q Silver
- S Silver, matte-tin
- G Gold over silver
- R Gold over silver, matte-tin

### Seal

- E Epoxy
- I Epoxy potted base

### Actuator Color

- 2 Black
- 1 White
- 3 Red

### Frame Color

- 2 Black
- NONE No frame color required
- 1 White

### Metal Frame Color

- (J11, J19, J21 & J37 Actuators)
- 2 Black
- 1 White

Rocker



G



Dimensions are shown: Inches (mm)  
Specifications and dimensions subject to change

# 7000 Series Miniature Rocker & Lever Handle Switches

## SWITCH FUNCTION

NO. POLES	MODEL NO.	UL/CSA** MODEL NO.	SWITCH FUNCTION			CONNECTED TERMINALS			SCHEMATIC
			POS. 1	POS. 2	POS. 3	POS. 1	POS. 2	POS. 3	
			C&K marking on opposite side			C&K marking on opposite side			
SP	7101	U11	ON	NONE	ON	2-3	N/A	2-1	
	7103	U13	ON	OFF	ON				
	7105	U15	MOM.	OFF	MOM.				
	7107	U17	ON	OFF	MOM.				
	7108	U18	ON	NONE	MOM.				
	7109	U19	NONE	ON	MOM.				
			N/A	2-3	2-1	SPDT			

### SPDT

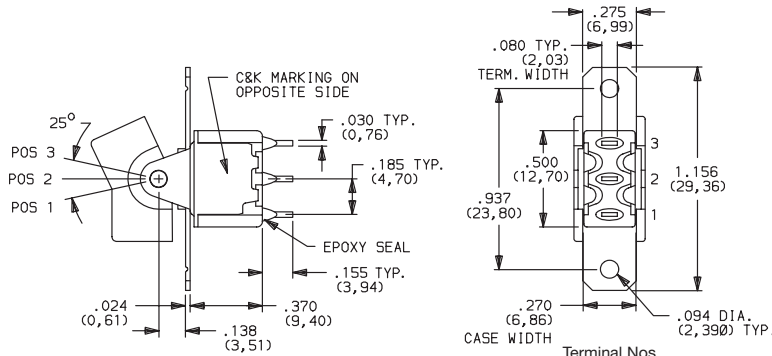

Part number shown: 7101J1ZQE2

Terminal Nos. For Reference Only

DP	7201	U21	ON	NONE	ON	2-3,5-6	N/A	2-1,5-4	
	7203	U23	ON	OFF	ON				
	7205	U25	MOM.	OFF	MOM.				
	7207	U27	ON	OFF	MOM.				
	7208	U28	ON	NONE	MOM.				
	7211*	U211*	ON	ON	ON				
	7213*	U213*	ON	ON	MOM.				
	7215*	U215*	MOM.	ON	MOM.				
						2-3,5-4	DPDT		

### DPDT

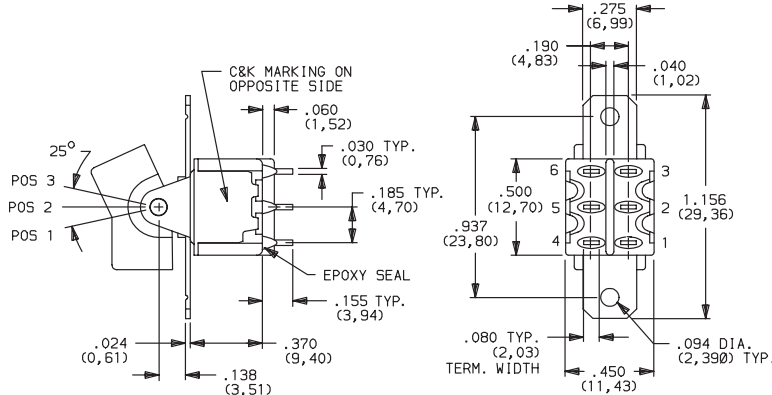

Part number shown: 7201J1ZQE2

Terminal Nos. For Reference Only

MOM. = Momentary

\*\* U11 through U413 model nos. with all options when ordered with G, Q, R or S contact material.

\* Wiring for 3-way switch, see Section N.



Dimensions are shown: Inches (mm)  
Specifications and dimensions subject to change



# 7000 Series Miniature Rocker & Lever Handle Switches

## SWITCH FUNCTION

NO. POLES	MODEL NO.	UL/CSA** MODEL NO.	SWITCH FUNCTION			CONNECTED TERMINALS			SCHEMATIC
			POS. 1	POS. 2	POS. 3	POS. 1	POS. 2	POS. 3	
3P	<b>7301</b>	<b>U31</b>	ON	NONE	ON	2-3,5-6,8-9	N/A	2-1,5-4,8-7	 3PDT
	<b>7303</b>	<b>U33</b>	ON	OFF	ON		OPEN		

### 3PDT



Part number shown: 7301J1ZQE2

NO. POLES	MODEL NO.	UL/CSA** MODEL NO.	SWITCH FUNCTION			CONNECTED TERMINALS			SCHEMATIC
			POS. 1	POS. 2	POS. 3	POS. 1	POS. 2	POS. 3	
4P	<b>7401</b>	<b>U41</b>	ON	NONE	ON	2-3,5-6,8-9,11-12	N/A	2-1,5-4,8-7,11-10	 4PDT
	<b>7405</b>	<b>U45</b>	MOM.	OFF	MOM.		OPEN		
	<b>7411*</b>	<b>U411*</b>	ON	ON	ON				

### 4PDT



Part number shown: 7401J1ZQE2

Rocker

MOM. = Momentary

\*\* U11 through U411 model nos. with all options when ordered with G, Q, R or S contact material.

\* Wiring for 3-way switch: See Technical Data section of this catalog for RoHS compliant and compatible definitions and specifications.



Dimensions are shown: Inches (mm)

Specifications and dimensions subject to change



# 7000 Series Miniature Rocker & Lever Handle Switches

## ACTUATOR-PANEL REAR MOUNT



### J1 ROCKER



OPTION CODE	ACTUATOR COLOR
2	BLACK
1	WHITE
3	RED

Finish: Matte. Other colors, custom actuator markings and legends available, consult Customer Service Center.

**NOTE:** Hardware: two each—mounting screws, nuts, lockwashers and standoffs for 1/8 inch thick panel are supplied standard on all switches with panel mounting brackets. Actuators available separately, see page G-22. Hardware is available see Technical Data section of this catalog.

J1, J2, J3, J8 & J10 Actuators available with C, W-W5, Z or Z3 terminations.

### J2 LEVER



### PANEL MOUNTING

#### J1 & J2 Actuators



### J3 ROCKER



#### J3 Actuator



### J8 ROCKER



#### J8 Actuator



### J10 ROCKER



#### J10 Actuator

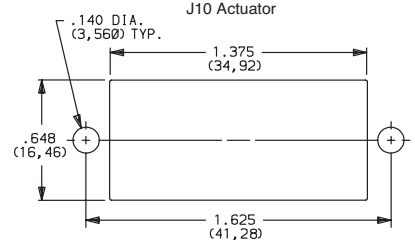

Third Angle Projection

Dimensions are shown: Inches (mm)

Specifications and dimensions subject to change



# 7000 Series Miniature Rocker & Lever Handle Switches

## ACTUATOR-SNAP-IN FRONT MOUNT



OPTION CODE	ACTUATOR COLOR
2	BLACK
1	WHITE
3	RED

OPTION CODE	FRAME COLOR
2	BLACK
NONE	No Frame Color (J15 or J25 options)
1	WHITE

Finish: Matte. Other colors, custom actuator markings and legends available, consult Customer Service Center.

**NOTE:** Actuators & frames available separately, see pages G-22 and G-25. J15, J16, J25, J26, J50 & J51 Actuators available with 71XX, 72XX, U1XX & U2XX models and C, W-W5, Z and Z3 terminations.

### PANEL MOUNTING

J15, J16, J25 & J26 Actuators



J50 Actuator



\* For J50: Increase this dimension to .620/.625 (15,75/15,88) for .091/.125 (2,31/3,18) thk. panels.

### J15 ROCKER, SNAP-IN



No frame color choice required



### J16 ROCKER WITH FRAME, SNAP-IN



### J25 LEVER, SNAP-IN



No frame color choice required



### J26 LEVER WITH FRAME, SNAP-IN

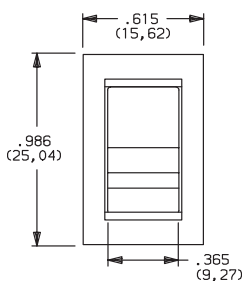

### J50 ROCKER, SNAP-IN

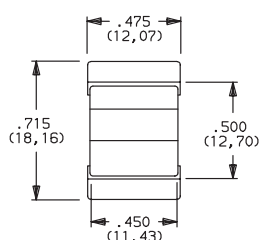

No frame color choice required



Third Angle Projection

Dimensions are shown: Inches (mm)

Specifications and dimensions subject to change

Rocker



G

**C&K**

# 7000 Series Miniature Rocker & Lever Handle Switches

## ACTUATOR-SNAP-IN FRONT MOUNT

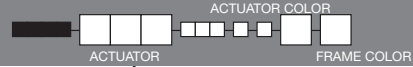

### J51 ROCKER WITH FRAME, SNAP-IN



OPTION CODE	ACTUATOR COLOR
2	BLACK
1	WHITE
3	RED

### J52 ROCKER WITH FRAME FOR LED, SNAP-IN

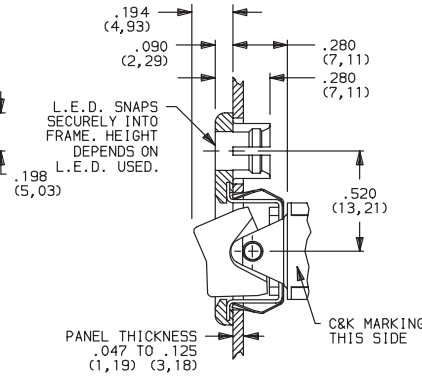

OPTION CODE	FRAME COLOR
2	BLACK
NONE	No Frame Color (J15 or J25 options)
1	WHITE

Finish: Matte. Other colors, custom actuator markings and legends available, consult Customer Service Center.

**NOTE:** Actuators & frames available separately, see pages G-22 and G-25. J51, J52, J60 & J61 Actuators available with 71XX, 72XX, U1XX & U2XX models and C, W-W5, Z and Z3 terminations.

LED not included.  
For LED information, see page H-24.

### J60 LEVER, SNAP-IN

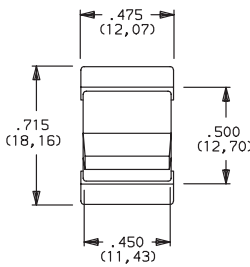

#### PANEL MOUNTING

J51, J60 & J61 Actuators

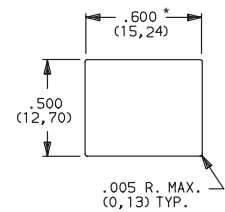

J52 Actuator



For J51, J52: Increase this dimension to .620/.625 (15,75/15,88) for .060/.125(1,52/3,18) thk. panels.

No frame color choice required

### J61 LEVER WITH FRAME, SNAP-IN



Third Angle Projection  
Dimensions are shown: Inches (mm)  
Specifications and dimensions subject to change



# 7000 Series Miniature Rocker & Lever Handle Switches

## ACTUATOR-SNAP-IN FRONT MOUNT



OPTION CODE	ACTUATOR COLOR
2	BLACK
1	WHITE
3	RED

OPTION CODE	FRAME COLOR
2	BLACK
NONE	No Frame Color (J90 options)
1	WHITE

Finish: Matte. Other colors, custom actuator markings and legends available, consult Customer Service Center.

**NOTE:** Actuators & frames available separately, see pages G-22 and G-25. J62, J90 & J91 Actuators available with 71XX, 72XX, U1XX & U2XX models and C, W-W5, Z & Z3 terminations.

### PANEL MOUNTING

J62 Actuator



J90, J91 & J93 Actuators

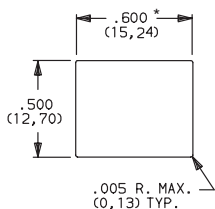

\* For J90: Increase this dimension to .620/.625 (15,75/15,88) for .091/.125 (2,31/3,18) thk. panels.  
For J91: Increase this dimension to .620/.625 (15,75/15,88) for .060/.125 (1,52/3,18) thk. panels.

### J62 LEVER WITH FRAME FOR LED, SNAP-IN



**LED not included.**  
For LED information, see page H-25.



### J90 LEVER, SNAP-IN



No frame color choice required.



### J91 LEVER WITH FRAME, SNAP-IN



Rocker



G

**C&K**



Third Angle Projection

Dimensions are shown: Inches (mm)  
Specifications and dimensions subject to change

# 7000 Series Miniature Rocker & Lever Handle Switches

## ACTUATOR-REAR MOUNT



**J11** ROCKER WITH FRAME



OPTION CODE	ACTUATOR COLOR
2	BLACK
1	WHITE
3	RED

OPTION CODE	FRAME COLOR
2	BLACK
1	WHITE

Actuator finish: Matte. Frame finish: Gloss. Other colors, custom actuator markings and legends available, consult Customer Service Center.

**NOTE:** Actuators & frames available separately, see pages G-22 and G-25. J11, J19, J21 & J37 Actuators available with C, W-W5, Z & Z3 terminations.

**J19** ROCKER WITH FRAME



### PANEL MOUNTING

J11 & J21 Actuators



J19 Actuator



J37 Actuator



**J21** LEVER WITH FRAME



**J37** ROCKER WITH FRAME



Dimensions are shown: Inches (mm)  
 Specifications and dimensions subject to change





# 7000 Series Miniature Rocker & Lever Handle Switches

## ACTUATOR-PC MOUNT



OPTION CODE	ACTUATOR COLOR
2	BLACK
1	WHITE
3	RED

Finish: Matte. Other colors, custom actuator markings and legends available, consult Customer Service Center.

**NOTE:** Some permissible actuator/termination combinations may lack clearance between actuator and PC board, and care must be exercised to accommodate this condition.

Actuators available separately, see page G-22. J1, J2 & J8 actuators available with A, A3, AV2, AV3, AW3 & V2 terminations. J3 actuators available with AV2, AV3 & V2-V61 terminations. J50 actuators available with A (DP, 3P models only), A3 (DP, 3P models only), AV2, AV3, AW3 (DP, 3P models only) & V2-V61 terminations.

### J1 ROCKER

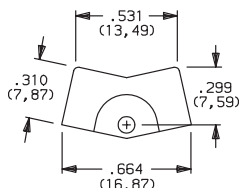

### J2 LEVER

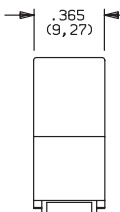
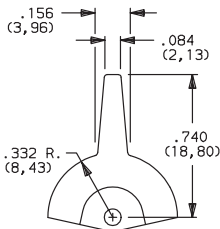

### J3 ROCKER

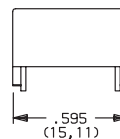
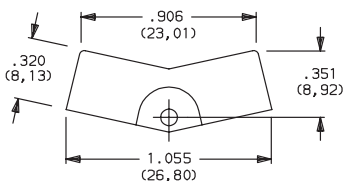

### J8 ROCKER

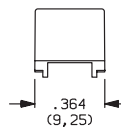
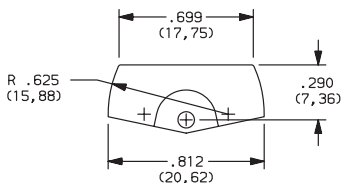

### J50 ROCKER

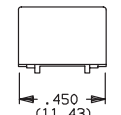
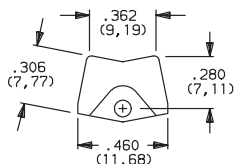

Rocker



G

**C&K**



Third Angle Projection

Dimensions are shown: Inches (mm)  
Specifications and dimensions subject to change

# 7000 Series Miniature Rocker & Lever Handle Switches

## ACTUATOR-PC MOUNT



### J60 LEVER



OPTION CODE	ACTUATOR COLOR
2	BLACK
1	WHITE
3	RED

Finish: Matte. Other colors, custom actuator markings and legends available, consult Customer Service Center.

**NOTE:** Some permissible actuator/termination combinations may lack clearance between actuator and PC board, and care must be exercised to accommodate this condition.

### J90 LEVER



Actuators available separately, see page G-22. J60 & J90 actuators available with A (DP, 3P models only), A3 (DP, 3P models only), AV2, AV3, AW3 (DP, 3P models only) & V2-V61 terminations.

## TERMINATIONS



### Z SOLDER LUG



### SPDT thru 4PDT

Not available with P, R or S contact materials. Available actuators, see pages G-7 through G-13.

### C PC THRU-HOLE



### SPDT thru 4PDT

**NOTE:** Available actuators, see pages G-7 through G-13.

### PC MOUNTING



### Z3 QUICK CONNECT

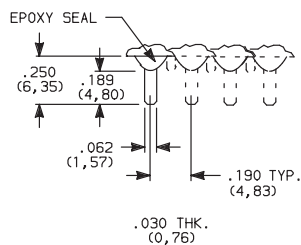

### SPDT thru 4PDT

Not available with P, R or S contact materials. Available actuators, see pages G-7 through G-13. Mating quick connector available; order part number 530100000, page G-23.

### W, W3, W5 WIRE WRAP



### SPDT thru 4PDT

**NOTE:** Available actuators, see pages G-7 through G-13.

OPTION CODE	DIM 'A'
W	.750 (19,05)
W3	.425 (10,80)
W5	1.305 (33,15)



Third Angle Projection

Dimensions are shown: Inches (mm)  
Specifications and dimensions subject to change



# 7000 Series Miniature Rocker & Lever Handle Switches

## TERMINATIONS

### A RIGHT ANGLE, PC THRU-HOLE



### A3 RIGHT ANGLE, SNAP-IN, PC THRU-HOLE

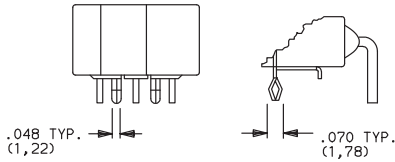

### AW3 RIGHT ANGLE, EXTENDED, PC THRU-HOLE

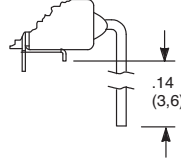

### PC MOUNTING

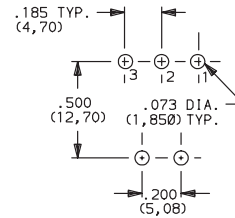

Not available with I seal option. Available actuators, see pages G-7 and G-13.  
Terminal bend radii and lead-in manufacturing option.

NOTE: PC pattern must clear switch support leg.

### A RIGHT ANGLE, PC THRU-HOLE

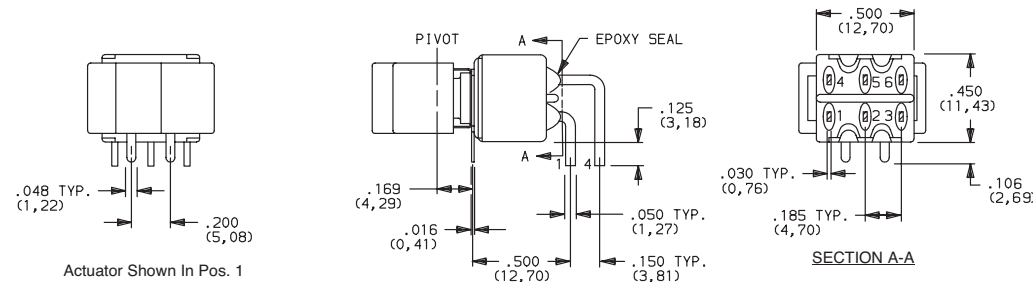

### A3 RIGHT ANGLE, SNAP-IN, PC THRU-HOLE

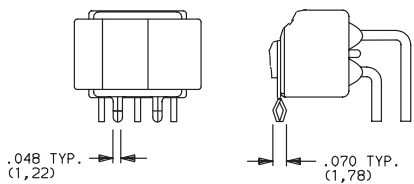

### PC MOUNTING

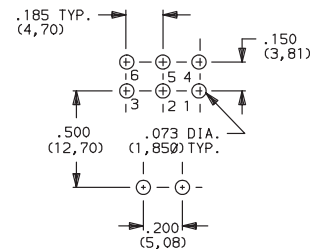

Rocker

Not available with I seal option. Available actuators, see pages G-7 and G-13.  
Terminal bend radii and lead-in manufacturing option.

Third Angle Projection

Dimensions are shown: Inches (mm)

Specifications and dimensions subject to change



# 7000 Series Miniature Rocker & Lever Handle Switches

## TERMINATIONS

### A RIGHT ANGLE, PC THRU-HOLE



**7301J1ABE2**  
Horizontal Actuation  
**3PDT**

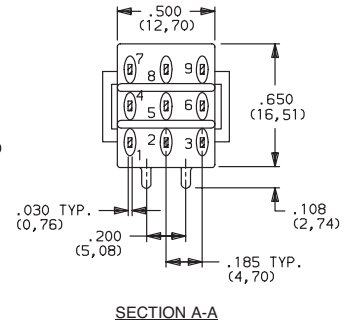
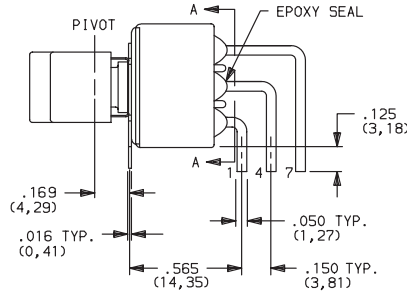

### PC MOUNTING



Not available with I seal option. Available actuators, see pages G-7 and G-13.  
Terminal bend radii and lead-in manufacturing option.

### AV2 VERTICAL RIGHT ANGLE, PC THRU-HOLE, .150" PITCH

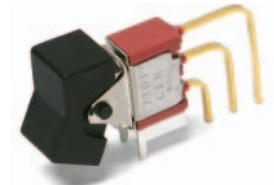

**7101J1AV2BE2**  
Vertical Actuation  
**SPDT**

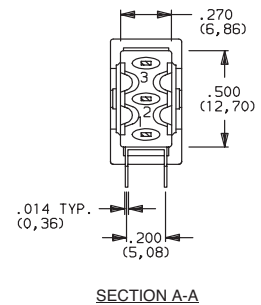
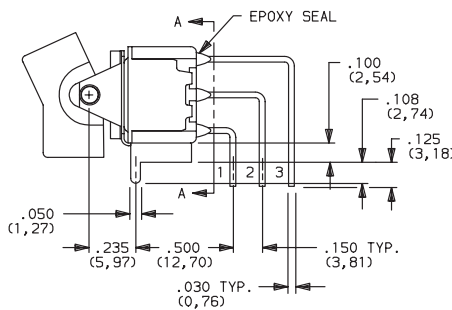
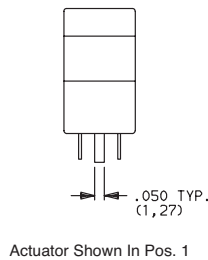

### AV3 VERTICAL RIGHT ANGLE, SNAP-IN, PC THRU-HOLE, .150" PITCH

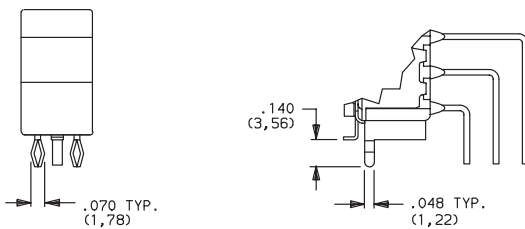

### PC MOUNTING



Not available with I seal option. Available actuators, see pages G-7 and G-13.  
Terminal bend radii and lead-in manufacturing option.



# 7000 Series Miniature Rocker & Lever Handle Switches

## TERMINATIONS

**AV2** VERTICAL RIGHT ANGLE, PC THRU-HOLE,  
.150" PITCH

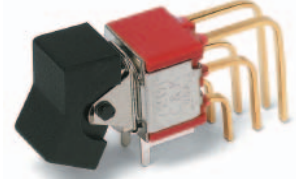

**7201J1AV2BE2**  
Vertical Actuation  
**DPDT**

**AV3** VERTICAL RIGHT ANGLE, SNAP-IN, PC THRU-HOLE,  
.150" PITCH



### PC MOUNTING



Not available with I seal option. Available actuators, see pages G-7 and G-13.  
Terminal bend radii and lead-in manufacturing option.

**AV2** VERTICAL RIGHT ANGLE, PC THRU-HOLE,  
.150" PITCH



**7301J1AV2BE2**  
Vertical Actuation  
**3PDT**

**AV3** VERTICAL RIGHT ANGLE, SNAP-IN, PC THRU-HOLE,  
.150" PITCH



### PC MOUNTING



Not available with I seal option. Available actuators, see pages G-7 and G-13.  
Terminal bend radii and lead-in manufacturing option.



Third Angle Projection

Dimensions are shown: Inches (mm)  
Specifications and dimensions subject to change

Rocker



G

**C&K**

# 7000 Series Miniature Rocker & Lever Handle Switches

## TERMINATIONS

**AV2** VERTICAL RIGHT ANGLE, PC THRU-HOLE,  
.150" PITCH



**7401J1AV2BE2**  
Vertical Actuation  
4PDT

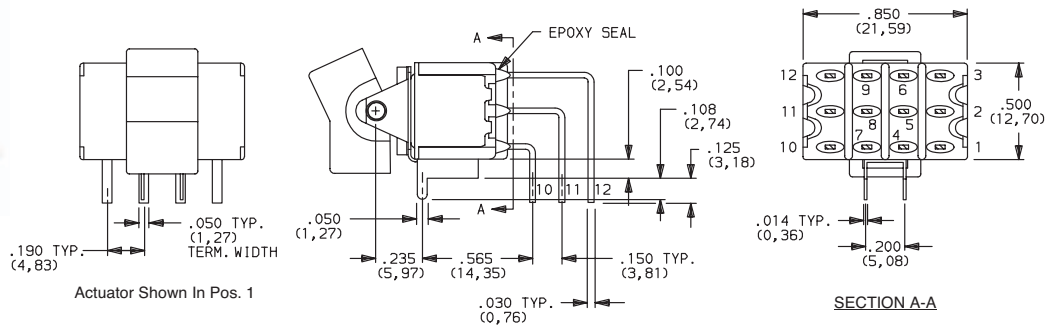

**AV3** VERTICAL RIGHT ANGLE, SNAP-IN, PC THRU-HOLE,  
.150" PITCH

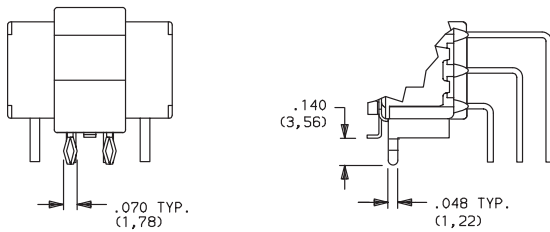

### PC MOUNTING

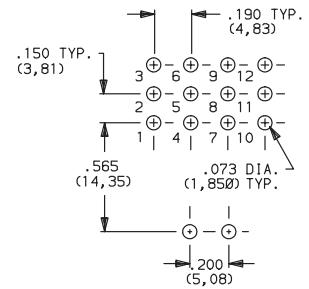

Not available with I seal option. Available actuators, see pages G-7 and G-13.  
Terminal bend radii and lead-in manufacturing option.

**V5** VERTICAL RIGHT ANGLE, PC THRU-HOLE,  
.150" PITCH



**7101J1V5BE2**  
Vertical Actuation  
SPDT

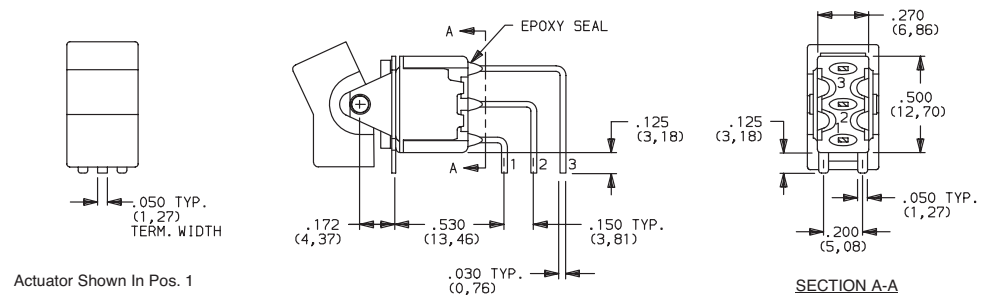

**V51** VERTICAL RIGHT ANGLE, SNAP-IN,  
PC THRU-HOLE, .150" PITCH



### PC MOUNTING



Not available with I seal option. Available actuators, see pages G-7 and G-13.  
Terminal bend radii and lead-in manufacturing option.



Dimensions are shown: Inches (mm)  
Specifications and dimensions subject to change



# 7000 Series Miniature Rocker & Lever Handle Switches

## TERMINATIONS

**V5** VERTICAL RIGHT ANGLE, PC THRU-HOLE,  
.150" PITCH



**V51** VERTICAL RIGHT ANGLE, SNAP-IN,  
PC THRU-HOLE, .150" PITCH



Not available with I seal option. Available actuators, see pages G-7 and G-13.  
Terminal bend radii and lead-in manufacturing option.

**V2, V6, V7, V8** VERTICAL MOUNT, V-BRACKET

**V61** VERTICAL MOUNT, V-BRACKET, SNAP-IN



OPTION CODE	DIM 'A'
V2, V21	.555 (14,10)
V6, V61	.460 (11,68)
V7	.630 (16,00)
V8	.953 (24,21)

Not available with I seal option.  
Available actuators, see pages G-7 and G-13.

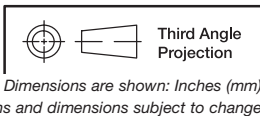

Rocker



G

**C&K**

# 7000 Series Miniature Rocker & Lever Handle Switches

## TERMINATIONS

**V2, V6, V7, V8** VERTICAL MOUNT, V-BRACKET

**V21, V61** VERTICAL MOUNT, V-BRACKET, SNAP-IN



7201J1\_BE2  
DPDT



OPTION CODE	DIM 'A'
V2, V21	.555 (14,10)
V6, V61	.460 (11,68)
V7	.630 (16,00)
V8	.953 (24,21)

Not available with I seal option.  
Available actuators, see pages G-7 and G-13.

**V2, V7, V8** VERTICAL MOUNT, V-BRACKET

**V21** VERTICAL MOUNT, V-BRACKET, SNAP-IN



7301J1\_BE2  
3PDT

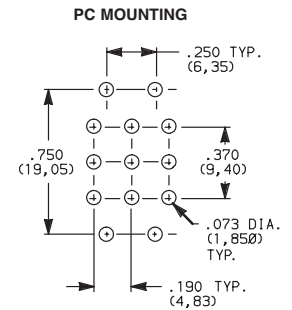

OPTION CODE	DIM 'A'
V2, V21	.555 (14,10)
V7	.630 (16,00)
V8	.953 (24,21)

Not available with I seal option.  
Available actuators, see pages G-7 and G-13.

**V2, V7, V8** VERTICAL MOUNT, V-BRACKET

**V21** VERTICAL MOUNT, V-BRACKET, SNAP-IN



7401J1\_BE2  
4PDT

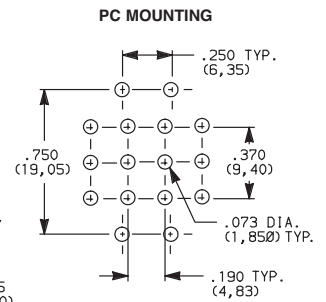
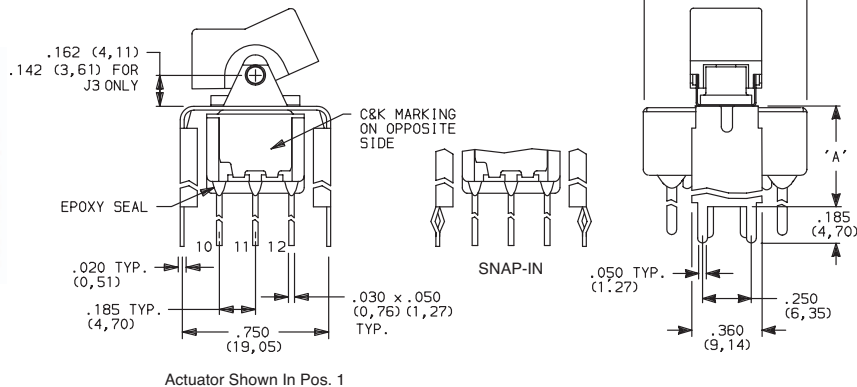

OPTION CODE	DIM 'A'
V2, V21	.555 (14,10)
V7	.630 (16,00)
V8	.953 (24,21)

Not available with I seal option.  
Available actuators, see pages G-7 and G-13.



Dimensions are shown: Inches (mm)  
Specifications and dimensions subject to change





# 7000 Series Miniature Rocker & Lever Handle Switches

## TERMINATIONS

**V3, V4, V9** VERTICAL MOUNT, V-BRACKET

**V31** VERTICAL MOUNT, V-BRACKET, SNAP-IN

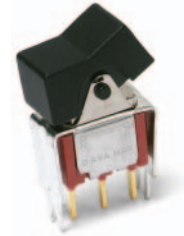
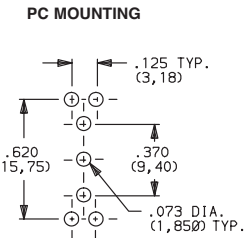

7101J1\_BE2  
SPDT

OPTION CODE	DIM 'A'
V3, V31	.460 (11,68)
V4	.630 (16,00)
V9	1.150 (29,21)

Not available with I seal option.  
Available actuators, see pages G-7 and G-13.

**V3, V4, V9** VERTICAL MOUNT, V-BRACKET

**V31** VERTICAL MOUNT, V-BRACKET, SNAP-IN

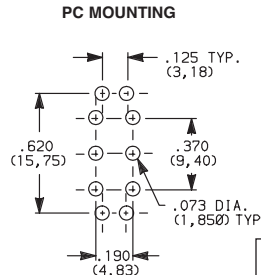
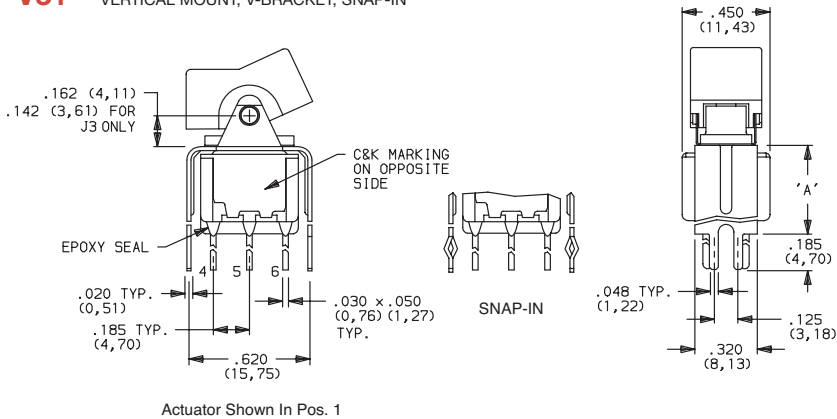

7201J1\_BE2  
DPDT

OPTION CODE	DIM 'A'
V3, V31	.460 (11,68)
V4	.630 (16,00)
V9	1.150 (29,21)

Not available with I seal option.  
Available actuators, see pages G-7 and G-13.

**V4, V9** VERTICAL MOUNT, V-BRACKET

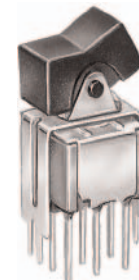
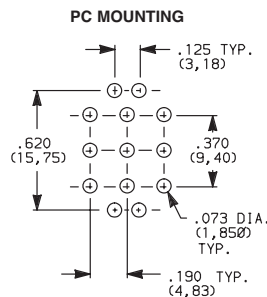
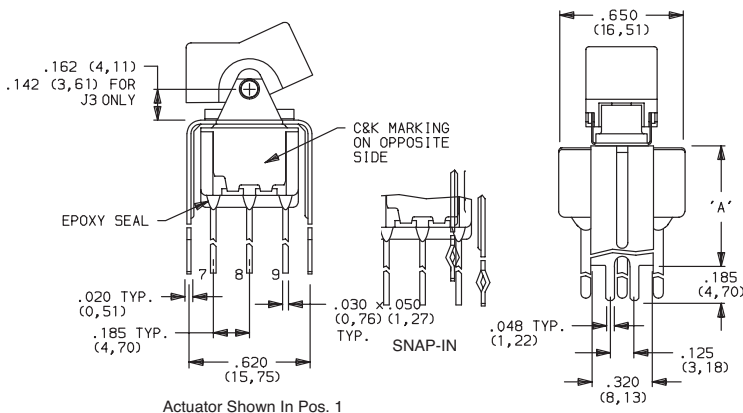

7301J1\_BE2  
3PDT

OPTION CODE	DIM 'A'
V4	.630 (16,00)
V9	1.150 (29,21)

Not available with I seal option.  
Available actuators, see pages G-7 and G-13.

Rocker



G



Third Angle Projection

Dimensions are shown: Inches (mm)  
Specifications and dimensions subject to change

# 7000 Series Miniature Rocker & Lever Handle Switches

## TERMINATIONS

**V4, V9** VERTICAL MOUNT, V-BRACKET



7401J1\_BE2  
4PDT



Actuator Shown In Pos. 1



PC MOUNTING



OPTION CODE	DIM 'A'
<b>V4</b>	.630 (16,00)
<b>V9</b>	1.150 (29,21)

Not available with I seal option.  
Available actuators, see pages G-7 and G-13.

## CONTACT MATERIAL

OPTION CODE	CONTACT MATERIAL	TERMINAL PLATING	RATINGS	
<b>B</b>	GOLD <sup>1</sup>	GOLD <sup>1</sup>	LOW LEVEL/ DRY CIRCUIT	0.4 VA MAX. @ 20 V AC OR DC MAX.
<b>P</b>		MATTE-TIN <sup>6</sup>		
<b>Q</b>	SILVER <sup>4,5</sup>	SILVER <sup>5</sup>	POWER	5 AMPS @ 120 V AC OR 28 V DC; 2 AMPS @ 250 V AC.
<b>S</b>		MATTE-TIN <sup>6</sup>		
<b>G</b>	GOLD OVER SILVER <sup>2,3</sup>	GOLD <sup>3</sup>	LOW LEVEL/DRY CIRCUIT OR POWER	0.4 VA MAX @ 20 V AC OR DC MAX OR 5 AMPS @ 120 V AC OR 28 V DC; 2 AMPS @ 250 V AC.
<b>R</b>		MATTE-TIN <sup>6</sup>		

\* Note: See Technical Data section of this catalog for RoHS compliant and compatible definitions and specifications.

- CONTACTS & TERMINALS: Copper alloy, with gold plate over nickel plate.
- END CONTACTS: Coin silver, with gold plate over nickel plate.
- CENTER CONTACTS & ALL TERMINALS: Copper alloy, with gold plate over nickel plate.
- END CONTACTS: Coin silver, silver plated.
- CENTER CONTACT & ALL TERMINALS: Copper alloy, silver plated.
- TERMINALS: Copper alloy, with matte-tin over nickel plate.

U11-U415 model numbers with all options when ordered with G, Q, S & R contact material.

B contact material standard with all terminations except C, Z & Z3.  
Q contact material standard with C, Z & Z3 terminations.

P, S & R, contact materials not available with Z & Z3 terminations.

**NOTE:** Any models supplied with Q, B, G, S, P & R contact material are RoHS compliant.

## SEAL

**E** EPOXY SEAL

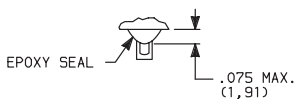

**I** EPOXY POTTED BASE

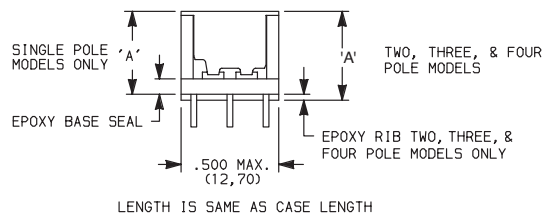

Available with C, W through W5, Z & Z3 terminations.

NO. POLES	DIM 'A'
SP	.410 (10,41)
DP	.440 (11,18)
3P	.505 (12,83)
4P	.505 (12,83)



Dimensions are shown: Inches (mm)  
Specifications and dimensions subject to change



# 7000 Series Miniature Rocker & Lever Handle Switches

## AVAILABLE HARDWARE

Panel mounting hardware for rocker and lever handle switches is available separately. Mounting hardware consists of two screws, two nuts, two standoffs and two lockwashers per switch, and is available for panel thicknesses of 1/16, 3/32 and 1/8 inch. See part numbers below.

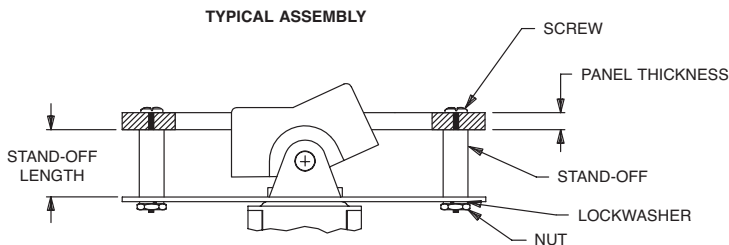

### J1 & J2 actuators

PART NO.	PANEL THK.	STANDOFF LENGTH
761103000	1/8 IN. (3,18)	.233 (5,92)

### J3 actuators

PART NO.	PANEL THK.	STANDOFF LENGTH
770603000	1/8 IN. (3,18)	.233 (5,92)

### J10 actuators

PART NO.	PANEL THK.	STANDOFF LENGTH
770703000	1/8 IN. (3,18)	.233 (5,92)

### MATERIAL

Screws, nuts, lockwashers: Stainless steel. Standoffs: Nylon, standard.

### J1, J11, J15 & J16 Actuators



PART NO.  
776A01000 WHITE  
776A02263 BLACK  
776A03000 RED

Material: Nylon  
Finish: Matte

### J2, J21, J25 & J26 Actuators



PART NO.  
426D01000 WHITE  
426D02263 BLACK  
426D03000 RED

Material: Nylon  
Finish: Matte

### J3 & J37 Actuators



PART NO.  
431D01000 WHITE  
431D02263 BLACK  
431D03000 RED

Material: Nylon  
Finish: Matte

### J50, J51 & J52 Actuators



PART NO.  
775A01000 WHITE  
775A02263 BLACK  
775A03000 RED

Material: Nylon  
Finish: Matte

### J60, J61 & J62 Actuators



PART NO.  
598101000 WHITE  
613802263 BLACK  
598103000 RED

Material: Nylon  
Finish: Matte

### J8 Actuator



PART NO.  
488701000 WHITE  
488702263 BLACK  
488703000 RED

Material: Nylon  
Finish: Matte

Rocker



G

**C&K**

Dimensions are shown: Inches (mm)  
Specifications and dimensions subject to change

# 7000 Series Miniature Rocker & Lever Handle Switches

## AVAILABLE HARDWARE

J90 & J91 Actuators



PART NO.

598001000 WHITE  
598002263 BLACK  
598003000 RED

Material: Nylon  
Finish: Matte

J10 & J19 Actuators



PART NO.

769501000 WHITE  
769502263 BLACK  
769503000 RED

Material: Nylon  
Finish: Matte

Fits Z3 Termination  
female connector



PART NO.

530100000

Available in loose pieces.

Frame for J11 & J21 Actuators



PART NO.

764500746 BLACK ENAMEL  
764500747 WHITE ENAMEL  
764601106 RETAINING SPRING

Material: Spring Steel

Frame for J16 & J26 Actuators



PART NO.

459101000 WHITE  
459102000 BLACK  
459103000 RED

Material: Nylon  
Finish: Matte

Frame for J51, J61 & J91 Actuators



PART NO.

615601000 WHITE  
615602263 BLACK  
615603000 RED

Material: Nylon  
Finish: Matte

Frame for J19 Actuator



PART NO.

781000746 BLACK ENAMEL  
781000747 WHITE ENAMEL

Material: Spring Steel

Frame for J37 Actuator



PART NO.

445400746 BLACK ENAMEL  
445400747 WHITE ENAMEL

Material: Spring Steel

Frame for J52 & J62 Actuators



PART NO.

613301000 WHITE  
613302263 BLACK  
613303000 RED

Material: Nylon  
Finish: Matte



Third Angle  
Projection

Dimensions are shown: Inches (mm)  
Specifications and dimensions subject to change

# 7000 Series Miniature Rocker & Lever Handle Switches

## AVAILABLE HARDWARE

Frames snap into panel opening and are independent from switch mounting. Accurate positioning of the PC mounted switch relative to the panel opening is necessary to provide proper clearance between actuator and frame. Available in two basic styles and four panel thicknesses .047-.125 in. Material: Nylon. Finish: Matte.

### TYPICAL APPLICATION



#### J1 & J2 Actuators

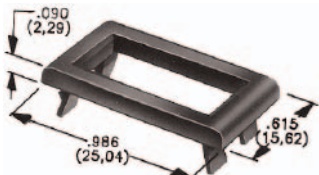

.047" (1,19) PANEL THK.	.062" (1,57) PANEL THK.	.090" (2,29) PANEL THK.	.125" (3,18) PANEL THK.
<b>PART NO.</b> 452902263	<b>PART NO.</b> 452702263	<b>PART NO.</b> 452802263	<b>PART NO.</b> 452602263 BLACK

#### J50, J60 & J90 Actuators

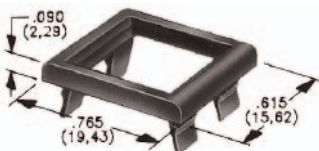

.047" (1,19) PANEL THK.	.062" (1,57) PANEL THK.	.090" (2,29) PANEL THK.	.125" (3,18) PANEL THK.
<b>PART NO.</b> 432502263	<b>PART NO.</b> 432602263	<b>PART NO.</b> 432702263	<b>PART NO.</b> 432802263 BLACK

### PANEL MOUNTING

For part numbers  
4529xxxxx, 4527xxxxx,  
4528xxxxx, 4526xxxxx



For part numbers  
4325xxxxx, 4326xxxxx



For part numbers  
4327xxxxx, 4328xxxxx



Rocker



G

**C&K**



Third Angle Projection

Dimensions are shown: Inches (mm)  
Specifications and dimensions subject to change

# 7000 Series Miniature Rocker & Lever Handle Switches

## AVAILABLE HARDWARE

### Panel Inserts

Will fit Separate Snap-in frames for J50, J60 & J90 actuators

Above frames (part nos. 432XXXXXX) are also available with insert which accepts LED for indicator light assembly. Order insert separately from frame. Blank insert panel (without hole for LED) also available. **LED not included.**



PANEL INSERT  
WITH HOLE FOR LED

PART NO.  
**894902000**

BLANK PANEL INSERT  
WITHOUT HOLE FOR LED

PART NO.  
**476602000** BLACK

**NOTE:** Special colors, custom markings available, consult Customer Service Center.

### LED INFORMATION

**Process Information:** Soldering to LED leads must be completed within 5 seconds at 500° F (260°C) maximum.

LEDs are not supplied with J52, J62 options. LED snaps into switch frame surrounding actuator and is wired externally.

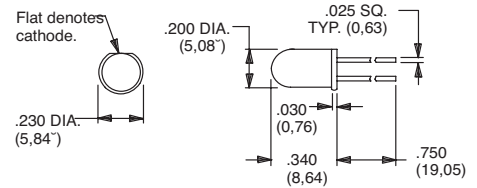

Suggested LED for J52 & J62 options.  
Dimensions for reference only.