



6A, High Speed MOSFET Drivers

FEATURES

- Latch Up Protected >1.5A
- Logic Input Swing Negative 5V
- ESD 4kV
- Matched Rise And Fall Times 20ns
- Reverse Output Current
- High Peak Output Current..... 6A Peak
- Wide Operating Range..... 4.5V to 18V
- High Capacitive Load Drive..... 10,000pF
- Short Delay Time..... 20ns Typ
- Logic High Input, Any Voltage..... 2.4V to V_{DD}
- Low Supply Current With Logic..... "1" Input 450µA
- Output Voltage Swing to Within 25mV of Ground or V_{DD}
- Pin Out Same as AS429

APPLICATIONS

- Motor Controls
- Switch-Mode Power Supplies
- Pulse Transformer Driver
- Class D Switching Amplifiers

PRODUCT DESCRIPTION

The ALPHA Semiconductor AS4420 and AS4429 family operates over 4.5V to 18V, can withstand high current peaking of 6A and have matched rise and fall times under 25ns. The product has been designed utilizing ALPHA Semiconductor's rugged CMOS process with protection for latch up and ESD. The product is available in inverting (AS4429) and noninverting (AS4420) configurations.

ORDERING INFORMATION

Part Number	Package Type	Logic
AS4420XS	8-Pin SOIC	Noninverting
AS4420XU	5-Pin TO-220	Noninverting
AS4420XP	8-Pin PDIP	Noninverting
AS4429XS	8-Pin SOIC	Inverting
AS4429XU	5-Pin TO-220	Inverting
AS4429XP	8-Pin PDIP	Inverting

X= I Industrial; C Commercial; M Military

PIN CONNECTIONS

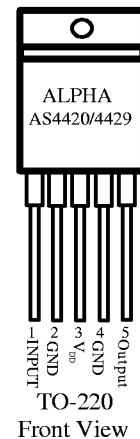
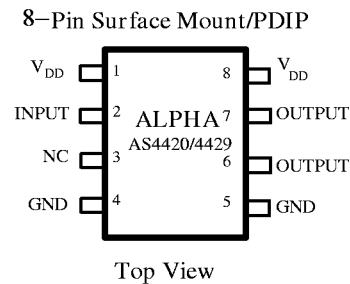

ELECTRICAL CHARACTERISTICS: Measured over operating temperature range with $4.5V \leq V_{DD} \leq 18V$, unless otherwise specified.

Parameter	Conditions	Min	Typ	Max	Units
INPUT					
Logic 1 High Input Voltage		2.4			V
Logic 0 Low Input Voltage				0.8	V
Input Voltage Range		-5		$V_{DD}+0.3$	V
Input Current	$0V \leq V_{IN} \leq V_S$	-10		10	μA
OUTPUT					
High Output Voltage	See Figure 1	$V_{DD}-0.025$			V
Low Output Voltage	See Figure 1			.025	V
Output Resistance, High	$I_{OUT} = 10mA, V_{DD} = 18V$		3	5	Ω
Output Resistance, Low	$I_{OUT} = 10mA, V_{DD} = 18V$		2.3	5	Ω
SWITCHING TIME (Note 1)					
Rise Time	Figure 1, $C_L = 2500pF$		35	60	ns
Fall Time	Figure 1, $C_L = 2500pF$		34	60	ns
Delay Time	Figure 1		20	50	ns
Delay Time	Figure 1		20	50	ns
POWER SUPPLY					
Power Supply Current	$V_{IN} = 3V$ $V_{in} = 0V$		1 60	3 400	mA μA
Operating Input Voltage		4.5		18	V

Note: 1. Switching times guaranteed by design.

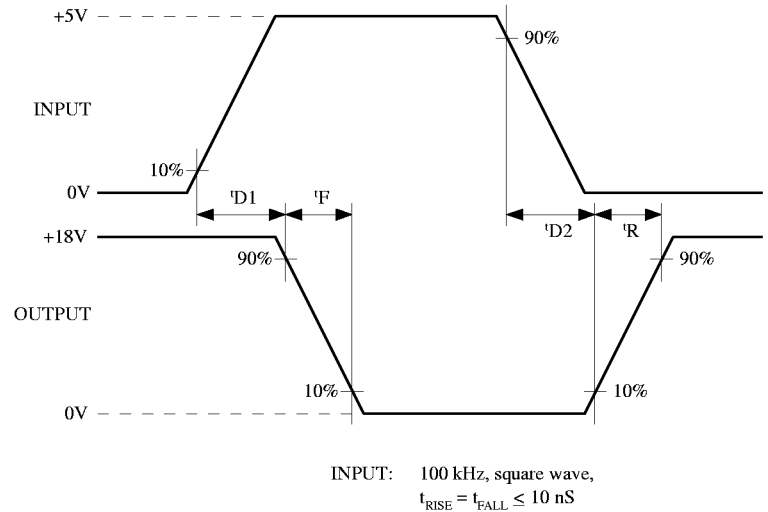
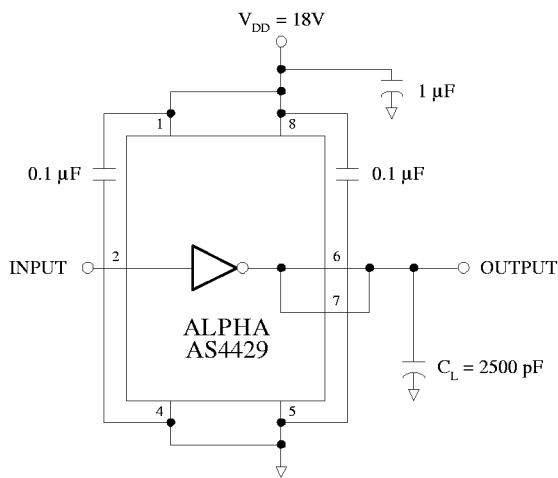
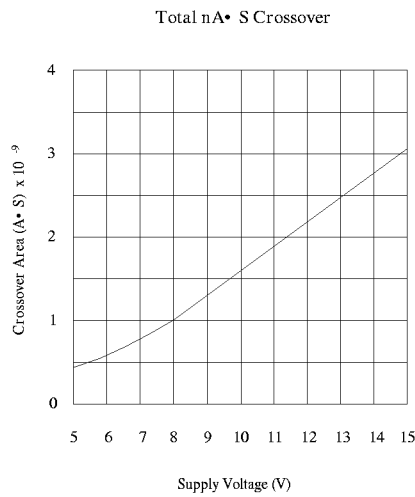
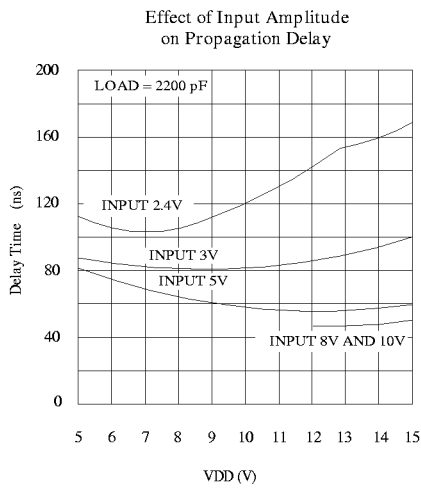
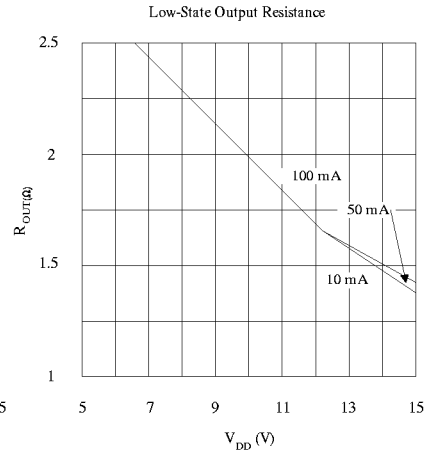
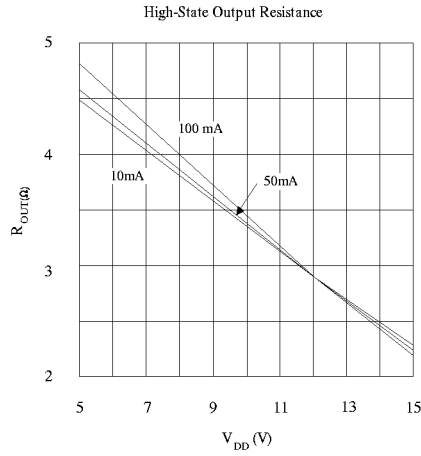
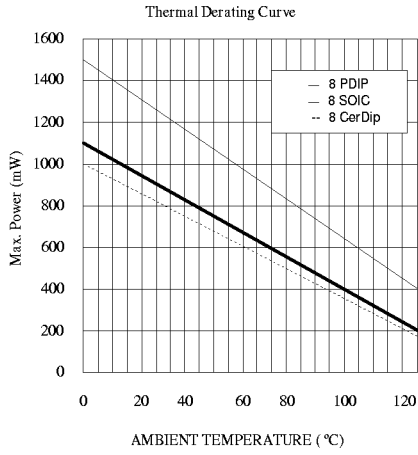
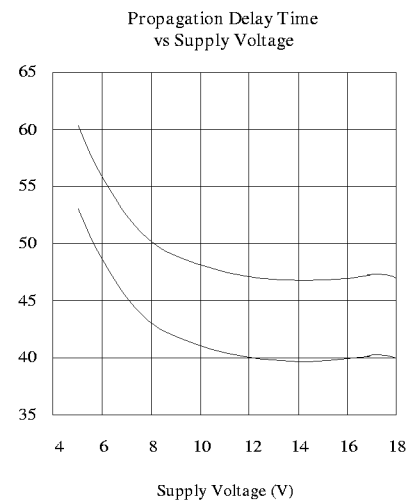
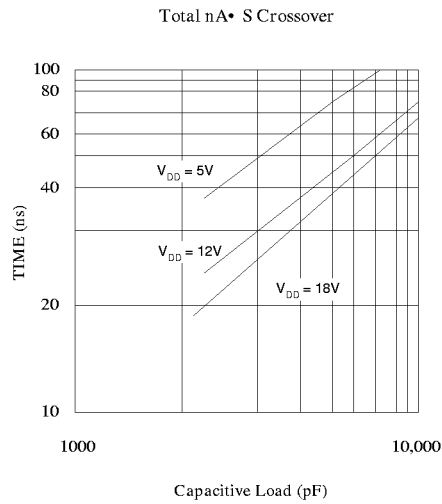
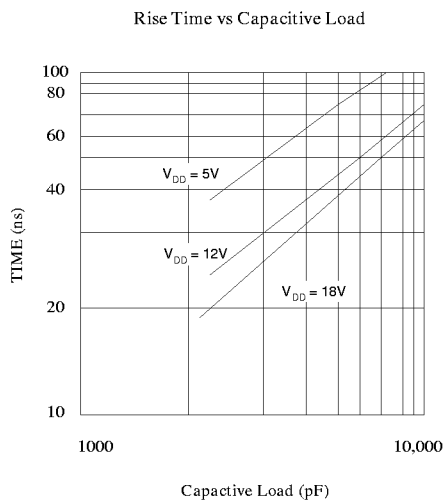
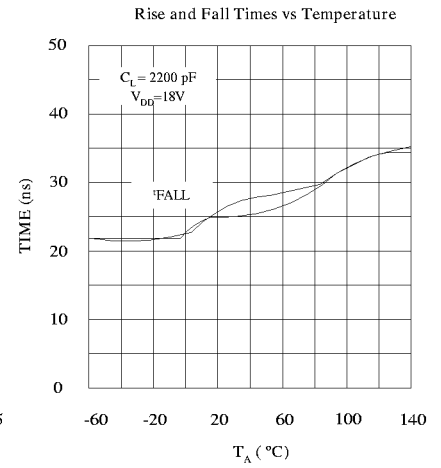
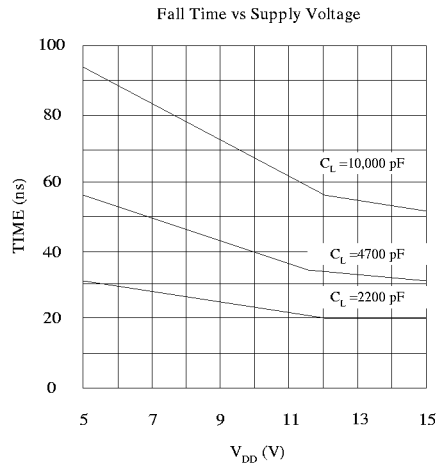
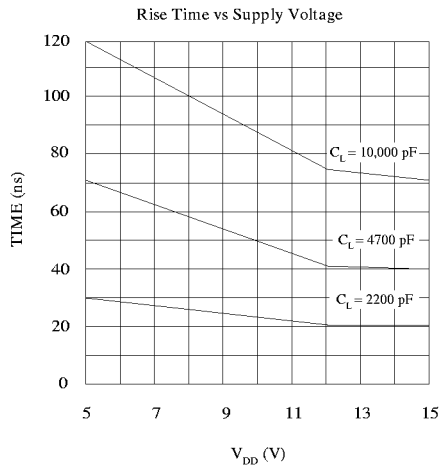

Figure 1. Switching Time Test Circuit

TYPICAL CHARACTERISTICS



TYPICAL CHARACTERISTICS (Cont.)



This datasheet has been downloaded from:

www.DatasheetCatalog.com

Datasheets for electronic components.