

Two-Line ESD-Protection in SOT23

Features

- Two-line ESD-protection device
- ESD-immunity acc. IEC 61000-4-2
 - ± 30 kV contact discharge
 - ± 30 kV air discharge
- Space saving SOT23 package
- AEC Q101 qualified
- Lead (Pb)-free component
- Lead finish = "e3" = matte tin (Sn)
- Component in accordance to RoHS 2002/95/EC and WEEE 2002/96/EC



RoHS
COMPLIANT

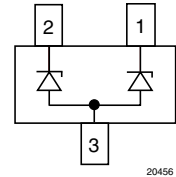
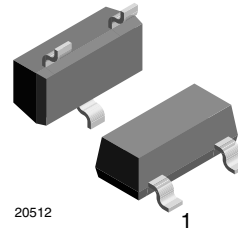

Marking (example only)

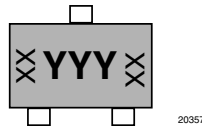

YYY = Type code (see table below)
XX = Date code

Ordering Information

Device name	Ordering code	Taped units per reel (8 mm tape on 7" reel)	Minimum order quantity
GSOT03C	GSOT03C-GS08	3000	15 000
GSOT04C	GSOT04C-GS08	3000	15 000
GSOT05C	GSOT05C-GS08	3000	15 000
GSOT08C	GSOT08C-GS08	3000	15 000
GSOT12C	GSOT12C-GS08	3000	15 000
GSOT15C	GSOT15C-GS08	3000	15 000
GSOT24C	GSOT24C-GS08	3000	15 000
GSOT36C	GSOT36C-GS08	3000	15 000

Package Data

Device name	Package name	Marking code	Weight	Molding compound flammability rating	Moisture sensitivity level	Soldering conditions
GSOT03C	SOT23	03C	8.8 mg	UL 94 V-0	MSL level 1 (according J-STD-020)	260 °C/10 s at terminals
GSOT04C	SOT23	04C	8.8 mg	UL 94 V-0	MSL level 1 (according J-STD-020)	260 °C/10 s at terminals
GSOT05C	SOT23	05C	8.8 mg	UL 94 V-0	MSL level 1 (according J-STD-020)	260 °C/10 s at terminals
GSOT08C	SOT23	08C	8.8 mg	UL 94 V-0	MSL level 1 (according J-STD-020)	260 °C/10 s at terminals
GSOT12C	SOT23	12C	8.8 mg	UL 94 V-0	MSL level 1 (according J-STD-020)	260 °C/10 s at terminals
GSOT15C	SOT23	15C	8.8 mg	UL 94 V-0	MSL level 1 (according J-STD-020)	260 °C/10 s at terminals
GSOT24C	SOT23	24C	8.8 mg	UL 94 V-0	MSL level 1 (according J-STD-020)	260 °C/10 s at terminals
GSOT36C	SOT23	36C	8.8 mg	UL 94 V-0	MSL level 1 (according J-STD-020)	260 °C/10 s at terminals

GSOT03C to GSOT36C



Vishay Semiconductors

Absolute Maximum Ratings

GSOT03C

Rating	Test condition	Symbol	Value	Unit
Peak pulse current	Pin 1 to 3 or pin 2 to 3 Acc. IEC 61000-4-5, $t_p = 8/20 \mu s$; single shot	I_{PPM}	30	A
	Pin 1 to 2 or pin 2 to 1; pin 3 not connected Acc. IEC 61000-4-5, $t_p = 8/20 \mu s$; single shot	I_{PPM}	30	A
Peak pulse power	Pin 1 to 3 or pin 2 to 3 Acc. IEC 61000-4-5, $t_p = 8/20 \mu s$; single shot	P_{PP}	369	W
	Pin 1 to 2 or pin 2 to 1; pin 3 not connected Acc. IEC 61000-4-5, $t_p = 8/20 \mu s$; single shot	P_{PP}	504	W
ESD immunity	Contact discharge acc. IEC 61000-4-2; 10 pulses	V_{ESD}	± 30	kV
	Air discharge acc. IEC 61000-4-2; 10 pulses	V_{ESD}	± 30	kV
Operating temperature	Junction temperature	T_J	- 40 to + 125	$^{\circ}C$
Storage temperature		T_{STG}	- 55 to + 150	$^{\circ}C$

GSOT04C

Rating	Test condition	Symbol	Value	Unit
Peak pulse current	Pin 1 to 3 or pin 2 to 3 Acc. IEC 61000-4-5, $t_p = 8/20 \mu s$; single shot	I_{PPM}	30	A
	Pin 1 to 2 or pin 2 to 1; pin 3 not connected Acc. IEC 61000-4-5, $t_p = 8/20 \mu s$; single shot	I_{PPM}	30	A
Peak pulse power	Pin 1 to 3 or pin 2 to 3 Acc. IEC 61000-4-5, $t_p = 8/20 \mu s$; single shot	P_{PP}	429	W
	Pin 1 to 2 or pin 2 to 1; pin 3 not connected Acc. IEC 61000-4-5, $t_p = 8/20 \mu s$; single shot	P_{PP}	564	W
ESD immunity	Contact discharge acc. IEC 61000-4-2; 10 pulses	V_{ESD}	± 30	kV
	Air discharge acc. IEC 61000-4-2; 10 pulses	V_{ESD}	± 30	kV
Operating temperature	Junction temperature	T_J	- 40 to + 125	$^{\circ}C$
Storage temperature		T_{STG}	- 55 to + 150	$^{\circ}C$

GSOT05C

Rating	Test condition	Symbol	Value	Unit
Peak pulse current	Pin 1 to 3 or pin 2 to 3 Acc. IEC 61000-4-5, $t_p = 8/20 \mu s$; single shot	I_{PPM}	30	A
	Pin 1 to 2 or pin 2 to 1; pin 3 not connected Acc. IEC 61000-4-5, $t_p = 8/20 \mu s$; single shot	I_{PPM}	30	A
Peak pulse power	Pin 1 to 3 or pin 2 to 3 Acc. IEC 61000-4-5, $t_p = 8/20 \mu s$; single shot	P_{PP}	480	W
	Pin 1 to 2 or pin 2 to 1; pin 3 not connected Acc. IEC 61000-4-5, $t_p = 8/20 \mu s$; single shot	P_{PP}	612	W
ESD immunity	Contact discharge acc. IEC 61000-4-2; 10 pulses	V_{ESD}	± 30	kV
	Air discharge acc. IEC 61000-4-2; 10 pulses	V_{ESD}	± 30	kV
Operating temperature	Junction temperature	T_J	- 40 to + 125	$^{\circ}C$
Storage temperature		T_{STG}	- 55 to + 150	$^{\circ}C$



GSOT08C

Rating	Test condition	Symbol	Value	Unit
Peak pulse current	Pin 1 to 3 or pin 2 to 3 Acc. IEC 61000-4-5, $t_p = 8/20 \mu s$; single shot	I_{PPM}	18	A
	Pin 1 to 2 or pin 2 to 1; pin 3 not connected Acc. IEC 61000-4-5, $t_p = 8/20 \mu s$; single shot	I_{PPM}	18	A
Peak pulse power	Pin 1 to 3 or pin 2 to 3 Acc. IEC 61000-4-5, $t_p = 8/20 \mu s$; single shot	P_{PP}	345	W
	Pin 1 to 2 or pin 2 to 1; pin 3 not connected Acc. IEC 61000-4-5, $t_p = 8/20 \mu s$; single shot	P_{PP}	400	W
ESD immunity	Contact discharge acc. IEC 61000-4-2; 10 pulses	V_{ESD}	± 30	kV
	Air discharge acc. IEC 61000-4-2; 10 pulses	V_{ESD}	± 30	kV
Operating temperature	Junction temperature	T_J	- 40 to + 125	$^{\circ}C$
Storage temperature		T_{STG}	- 55 to + 150	$^{\circ}C$

GSOT12C

Rating	Test condition	Symbol	Value	Unit
Peak pulse current	Pin 1 to 3 or pin 2 to 3 Acc. IEC 61000-4-5, $t_p = 8/20 \mu s$; single shot	I_{PPM}	12	A
	Pin 1 to 2 or pin 2 to 1; pin 3 not connected Acc. IEC 61000-4-5, $t_p = 8/20 \mu s$; single shot	I_{PPM}	12	A
Peak pulse power	Pin 1 to 3 or pin 2 to 3 Acc. IEC 61000-4-5, $t_p = 8/20 \mu s$; single shot	P_{PP}	312	W
	Pin 1 to 2 or pin 2 to 1; pin 3 not connected Acc. IEC 61000-4-5, $t_p = 8/20 \mu s$; single shot	P_{PP}	337	W
ESD immunity	Contact discharge acc. IEC 61000-4-2; 10 pulses	V_{ESD}	± 30	kV
	Air discharge acc. IEC 61000-4-2; 10 pulses	V_{ESD}	± 30	kV
Operating temperature	Junction temperature	T_J	- 40 to + 125	$^{\circ}C$
Storage temperature		T_{STG}	- 55 to + 150	$^{\circ}C$

GSOT15C

Rating	Test condition	Symbol	Value	Unit
Peak pulse current	Pin 1 to 3 or pin 2 to 3 Acc. IEC 61000-4-5, $t_p = 8/20 \mu s$; single shot	I_{PPM}	8	A
	Pin 1 to 2 or pin 2 to 1; pin 3 not connected Acc. IEC 61000-4-5, $t_p = 8/20 \mu s$; single shot	I_{PPM}	8	A
Peak pulse power	Pin 1 to 3 or pin 2 to 3 Acc. IEC 61000-4-5, $t_p = 8/20 \mu s$; single shot	P_{PP}	230	W
	Pin 1 to 2 or pin 2 to 1; pin 3 not connected Acc. IEC 61000-4-5, $t_p = 8/20 \mu s$; single shot	P_{PP}	245	W
ESD immunity	Contact discharge acc. IEC 61000-4-2; 10 pulses	V_{ESD}	± 30	kV
	Air discharge acc. IEC 61000-4-2; 10 pulses	V_{ESD}	± 30	kV
Operating temperature	Junction temperature	T_J	- 40 to + 125	$^{\circ}C$
Storage temperature		T_{STG}	- 55 to + 150	$^{\circ}C$

GSOT03C to GSOT36C



Vishay Semiconductors

GSOT24C

Rating	Test condition	Symbol	Value	Unit
Peak pulse current	Pin 1 to 3 or pin 2 to 3 Acc. IEC 61000-4-5, $t_p = 8/20 \mu s$; single shot	I_{PPM}	5	A
	Pin 1 to 2 or pin 2 to 1; pin 3 not connected Acc. IEC 61000-4-5, $t_p = 8/20 \mu s$; single shot	I_{PPM}	5	A
Peak pulse power	Pin 1 to 3 or pin 2 to 3 Acc. IEC 61000-4-5, $t_p = 8/20 \mu s$; single shot	P_{PP}	235	W
	Pin 1 to 2 or pin 2 to 1; pin 3 not connected Acc. IEC 61000-4-5, $t_p = 8/20 \mu s$; single shot	P_{PP}	240	W
ESD immunity	Contact discharge acc. IEC 61000-4-2; 10 pulses	V_{ESD}	± 30	kV
	Air discharge acc. IEC 61000-4-2; 10 pulses	V_{ESD}	± 30	kV
Operating temperature	Junction temperature	T_J	- 40 to + 125	$^{\circ}C$
Storage temperature		T_{STG}	- 55 to + 150	$^{\circ}C$

GSOT36C

Rating	Test condition	Symbol	Value	Unit
Peak pulse current	Pin 1 to 3 or pin 2 to 3 Acc. IEC 61000-4-5, $t_p = 8/20 \mu s$; single shot	I_{PPM}	3.5	A
	Pin 1 to 2 or pin 2 to 1; pin 3 not connected Acc. IEC 61000-4-5, $t_p = 8/20 \mu s$; single shot	I_{PPM}	3.5	A
Peak pulse power	Pin 1 to 3 or pin 2 to 3 Acc. IEC 61000-4-5, $t_p = 8/20 \mu s$; single shot	P_{PP}	248	W
	Pin 1 to 2 or pin 2 to 1; pin 3 not connected Acc. IEC 61000-4-5, $t_p = 8/20 \mu s$; single shot	P_{PP}	252	W
ESD immunity	Contact discharge acc. IEC 61000-4-2; 10 pulses	V_{ESD}	± 30	kV
	Air discharge acc. IEC 61000-4-2; 10 pulses	V_{ESD}	± 30	kV
Operating temperature	Junction temperature	T_J	- 40 to + 125	$^{\circ}C$
Storage temperature		T_{STG}	- 55 to + 150	$^{\circ}C$

BiAs-Mode (2-line Bidirectional Asymmetrical protection mode)

With the **GSOTxxC** two signal- or data-lines (L1, L2) can be protected against voltage transients. With pin 3 connected to ground and pin 1 and pin 2 connected to a signal- or data-line which has to be protected. As long as the voltage level on the data- or signal-line is between 0 V (ground level) and the specified **Maximum Reverse Working Voltage** (V_{RWM}) the protection diode between pin 2 and pin 3 and between pin 1 and pin 3 offer a high isolation to the ground line. The protection device behaves like an open switch.

As soon as any positive transient voltage signal exceeds the break through voltage level of the protection diode, the diode becomes conductive and shorts the transient current to ground. Now the protection device behaves like a closed switch. The **Clamping Voltage** (V_C) is defined by the **Breakthrough Voltage** (V_{BR}) level plus the voltage drop at the series impedance (resistance and inductance) of the protection device.

Any negative transient signal will be clamped accordingly. The negative transient current is flowing in the forward direction of the protection diode. The low **Forward Voltage** (V_F) clamps the negative transient close to the ground level.

Due to the different clamping levels in forward and reverse direction the **GSOTxxC** clamping behaviour is **Bidirectional** and **Asymmetrical (BiAs)**.

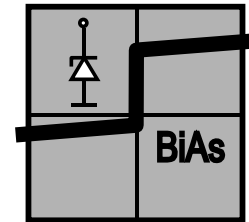
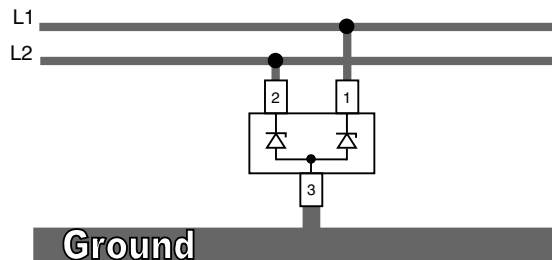

20358

If a higher surge current or **Peak Pulse current** (I_{PP}) is needed, both protection diodes in the **GSOTxxC** can also be used in parallel in order to "double" the performance.

- This offers:
- double surge power = double peak pulse current ($2 \times I_{PPM}$)
 - halve line inductance = reduced clamping voltage
 - halve line resistance = reduced clamping voltage
 - double **Diode Capacitance** ($2 \times C_D$)
 - double **Reverse leakage current** ($2 \times I_R$)

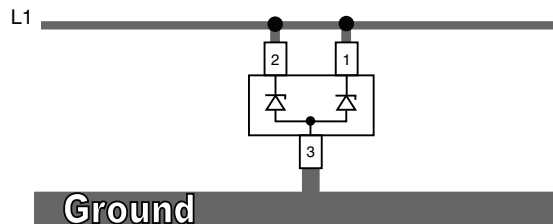

20359

Electrical Characteristics

Ratings at 25 °C, ambient temperature unless otherwise specified

GSOT03C

BiAs mode (between Pin 1 to 3 or pin 2 to 3)

Parameter	Test conditions/remarks	Symbol	Min.	Typ.	Max.	Unit
Protection paths	Number of lines which can be protected	N_{lines}			2	lines
Reverse stand off voltage	at $I_R = 100 \mu A$	V_{RWM}	3.3			V
Reverse current	at $V_R = 3.3 V$	I_R			100	μA
Reverse break down voltage	at $I_R = 1 mA$	V_{BR}	4	4.6		V
Reverse clamping voltage	at $I_{PP} = 1 A$	V_C		5.7	7.5	V
	at $I_{PP} = I_{PPM} = 30 A$	V_C		10	12.3	V
Forward clamping voltage	at $I_{PP} = 1 A$	V_F		1	1.2	V
	at $I_{PP} = I_{PPM} = 30 A$	V_F		4.5		V
Capacitance	at $V_R = 0 V$; $f = 1 MHz$	C_D		420	600	pF
	at $V_R = 1.6 V$; $f = 1 MHz$	C_D		260		pF

GSOT04C

BiAs mode (between Pin 1 to 3 or pin 2 to 3)

Parameter	Test conditions/remarks	Symbol	Min.	Typ.	Max.	Unit
Protection paths	Number of lines which can be protected	N_{lines}			2	lines
Reverse stand off voltage	at $I_R = 20 \mu A$	V_{RWM}	4			V
Reverse current	at $V_R = 4 V$	I_R			20	μA
Reverse break down voltage	at $I_R = 1 mA$	V_{BR}	5	6.1		V
Reverse clamping voltage	at $I_{PP} = 1 A$	V_C		7.5	9	V
	at $I_{PP} = I_{PPM} = 30 A$	V_C		11.2	14.3	V
Forward clamping voltage	at $I_{PP} = 1 A$	V_F		1	1.2	V
	at $I_{PP} = I_{PPM} = 30 A$	V_F		4.5		V
Capacitance	at $V_R = 0 V$; $f = 1 MHz$	C_D		310	450	pF
	at $V_R = 2 V$; $f = 1 MHz$	C_D		200		pF

GSOT05C

BiAs mode (between Pin 1 to 3 or pin 2 to 3)

Parameter	Test conditions/remarks	Symbol	Min.	Typ.	Max.	Unit
Protection paths	Number of lines which can be protected	N_{lines}			2	lines
Reverse stand off voltage	at $I_R = 10 \mu A$	V_{RWM}	5			V
Reverse current	at $V_R = 5 V$	I_R			10	μA
Reverse break down voltage	at $I_R = 1 mA$	V_{BR}	6	6.8		V
Reverse clamping voltage	at $I_{PP} = 1 A$	V_C		7	8.7	V
	at $I_{PP} = I_{PPM} = 30 A$	V_C		12	16	V
Forward clamping voltage	at $I_{PP} = 1 A$	V_F		1	1.2	V
	at $I_{PP} = I_{PPM} = 30 A$	V_F		4.5		V
Capacitance	at $V_R = 0 V$; $f = 1 MHz$	C_D		260	350	pF
	at $V_R = 2.5 V$; $f = 1 MHz$	C_D		150		pF



GSOT08C

BiAs mode (between Pin 1 to 3 or pin 2 to 3)

Parameter	Test conditions/remarks	Symbol	Min.	Typ.	Max.	Unit
Protection paths	Number of lines which can be protected	N_{lines}			2	lines
Reverse stand off voltage	at $I_R = 5 \mu A$	V_{RWM}	8			V
Reverse current	at $V_R = 8 V$	I_R			5	μA
Reverse break down voltage	at $I_R = 1 mA$	V_{BR}	9	10		V
Reverse clamping voltage	at $I_{PP} = 1 A$	V_C		10.7	13	V
	at $I_{PP} = I_{PPM} = 18 A$	V_C		15.2	19.2	V
Forward clamping voltage	at $I_{PP} = 1 A$	V_F		1	1.2	V
	at $I_{PP} = I_{PPM} = 18 A$	V_F		3		V
Capacitance	at $V_R = 0 V$; $f = 1 MHz$	C_D		160	250	pF
	at $V_R = 4 V$; $f = 1 MHz$	C_D		80		pF

GSOT12C

BiAs mode (between pin 1 to 3 or pin 2 to 3)

Parameter	Test conditions/remarks	Symbol	Min.	Typ.	Max.	Unit
Protection paths	Number of lines which can be protected	N_{lines}			2	lines
Reverse stand off voltage	at $I_R = 1 \mu A$	V_{RWM}	12			V
Reverse current	at $V_R = 12 V$	I_R			1	μA
Reverse break down voltage	at $I_R = 1 mA$	V_{BR}	13.5	15		V
Reverse clamping voltage	at $I_{PP} = 1 A$	V_C		15.4	18.7	V
	at $I_{PP} = I_{PPM} = 12 A$	V_C		21.2	26	V
Forward clamping voltage	at $I_{PP} = 1 A$	V_F		1	1.2	V
	at $I_{PP} = I_{PPM} = 12 A$	V_F		2.2		V
Capacitance	at $V_R = 0 V$; $f = 1 MHz$	C_D		115	150	pF
	at $V_R = 6 V$; $f = 1 MHz$	C_D		50		pF

GSOT15C

BiAs mode (between pin 1 to 3 or pin 2 to 3)

Parameter	Test conditions/remarks	Symbol	Min.	Typ.	Max.	Unit
Protection paths	Number of lines which can be protected	N_{lines}			2	lines
Reverse stand off voltage	at $I_R = 1 \mu A$	V_{RWM}	15			V
Reverse current	at $V_R = 15 V$	I_R			1	μA
Reverse break down voltage	at $I_R = 1 mA$	V_{BR}	16.5	18		V
Reverse clamping voltage	at $I_{PP} = 1 A$	V_C		19.4	23.5	V
	at $I_{PP} = I_{PPM} = 8 A$	V_C		24.8	28.8	V
Forward clamping voltage	at $I_{PP} = 1 A$	V_F		1	1.2	V
	at $I_{PP} = I_{PPM} = 8 A$	V_F		1.8		V
Capacitance	at $V_R = 0 V$; $f = 1 MHz$	C_D		90	120	pF
	at $V_R = 7.5 V$; $f = 1 MHz$	C_D		35		pF

GSOT24C

BiAs mode (between pin 1 to 3 or pin 2 to 3)

Parameter	Test conditions/remarks	Symbol	Min.	Typ.	Max.	Unit
Protection paths	Number of lines which can be protected	N_{lines}			2	lines
Reverse stand off voltage	at $I_R = 1 \mu A$	V_{RWM}	24			V
Reverse current	at $V_R = 24 V$	I_R			1	μA
Reverse break down voltage	at $I_R = 1 mA$	V_{BR}	27	30		V
Reverse clamping voltage	at $I_{PP} = 1 A$	V_C		34	41	V
	at $I_{PP} = I_{PPM} = 5 A$	V_C		41	47	V
Forward clamping voltage	at $I_{PP} = 1 A$	V_F		1	1.2	V
	at $I_{PP} = I_{PPM} = 5 A$	V_F		1.4		V
Capacitance	at $V_R = 0 V$; $f = 1 MHz$	C_D		65	80	pF
	at $V_R = 12 V$; $f = 1 MHz$	C_D		20		pF

GSOT36C

BiAs mode (between pin 1 to 3 or pin 2 to 3)

Parameter	Test conditions/remarks	Symbol	Min.	Typ.	Max.	Unit
Protection paths	Number of lines which can be protected	N_{lines}			2	lines
Reverse stand off voltage	at $I_R = 1 \mu A$	V_{RWM}	36			V
Reverse current	at $V_R = 36 V$	I_R			1	μA
Reverse break down voltage	at $I_R = 1 mA$	V_{BR}	39	43		V
Reverse clamping voltage	at $I_{PP} = 1 A$	V_C		49	60	V
	at $I_{PP} = I_{PPM} = 3.5 A$	V_C		59	71	V
Forward clamping voltage	at $I_{PP} = 1 A$	V_F		1	1.2	V
	at $I_{PP} = I_{PPM} = 3.5 A$	V_F		1.3		V
Capacitance	at $V_R = 0 V$; $f = 1 MHz$	C_D		52	65	pF
	at $V_R = 18 V$; $f = 1 MHz$	C_D		12		pF

BiSy-mode (1-line Bidirectional Symmetrical protection mode)

If a bipolar symmetrical protection device is needed the **GSOTxxC** can also be used as a single line protection device. Therefore pin 1 has to be connected to the signal- or data-line (L1) and pin 2 to ground (or vice versa). pin 3 must not be connected.

Positive and negative voltage transients will be clamped in the same way. The clamping current through the **GSOTxxC** passes one diode in forward direction and the other one in reverse direction. The **Clamping Voltage (V_C)** is defined by the **Breakthrough Voltage (V_{BR})** level of one diode plus the forward voltage of the other diode plus the voltage drop at the series impedances (resistances and inductances) of the protection device.

Due to the same clamping levels in positive and negative direction the **GSOTxxC** voltage clamping behaviour is **Bidirectional** and **Symmetrical (BiSy)**.

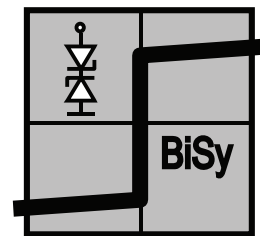
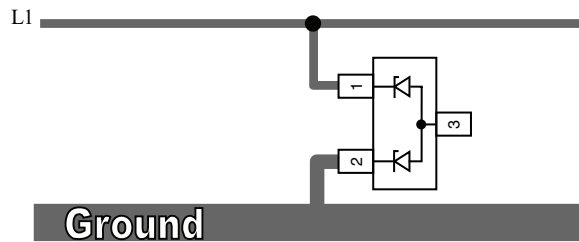

20361

Electrical Characteristics

Ratings at 25 °C, ambient temperature unless otherwise specified

GSOT03C

BiSy mode (between pin 1 to 2 or pin 2 to 1; pin 3 not connected)

Parameter	Test conditions/remarks	Symbol	Min.	Typ.	Max.	Unit
Protection paths	Number of lines which can be protected	N_{lines}			1	lines
Reverse stand off voltage	at $I_R = 100 \mu A$	V_{RWM}	3.8			V
Reverse current	at $V_R = 3.8 V$	I_R			100	μA
Reverse break down voltage	at $I_R = 1 mA$	V_{BR}	4.5	5.3		V
Clamping voltage	at $I_{PP} = 1 A$	V_C		7	8.4	V
	at $I_{PP} = I_{PPM} = 30 A$	V_C		14	16.8	V
Capacitance	at $V_R = 0 V$; $f = 1 MHz$	C_D		210	300	pF
	at $V_R = 1.6 V$; $f = 1 MHz$	C_D		190		pF

GSOT04C

BiSy mode (between pin 1 to 2 or pin 2 to 1; pin 3 not connected)

Parameter	Test conditions/remarks	Symbol	Min.	Typ.	Max.	Unit
Protection paths	Number of lines which can be protected	N_{lines}			1	lines
Reverse stand off voltage	at $I_R = 20 \mu A$	V_{RWM}	4.5			V
Reverse current	at $V_R = 4.5 V$	I_R			20	μA
Reverse break down voltage	at $I_R = 1 mA$	V_{BR}	5.5	6.8		V
Clamping voltage	at $I_{PP} = 1 A$	V_C		7.5	9	V
	at $I_{PP} = I_{PPM} = 30 A$	V_C		15.7	18.8	V
Capacitance	at $V_R = 0 V$; $f = 1 MHz$	C_D		155	225	pF
	at $V_R = 2 V$; $f = 1 MHz$	C_D		135		pF

GSOT05C

BiSy mode (between pin 1 to 2 or pin 2 to 1; pin 3 not connected)

Parameter	Test conditions/remarks	Symbol	Min.	Typ.	Max.	Unit
Protection paths	Number of lines which can be protected	N_{lines}			1	lines
Reverse stand off voltage	at $I_R = 10 \mu A$	V_{RWM}	5.5			V
Reverse current	at $V_R = 5.5 V$	I_R			10	μA
Reverse break down voltage	at $I_R = 1 mA$	V_{BR}	6.5	7.5		V
Clamping voltage	at $I_{PP} = 1 A$	V_C		8.1	9.7	V
	at $I_{PP} = I_{PPM} = 30 A$	V_C		17	20.4	V
Capacitance	at $V_R = 0 V$; $f = 1 MHz$	C_D		130	175	pF
	at $V_R = 2.5 V$; $f = 1 MHz$	C_D		100		pF

GSOT08C

BiSy mode (between pin 1 to 2 or pin 2 to 1; pin 3 not connected)

Parameter	Test conditions/remarks	Symbol	Min.	Typ.	Max.	Unit
Protection paths	Number of lines which can be protected	N_{lines}			1	lines
Reverse stand off voltage	at $I_R = 5 \mu A$	V_{RWM}	8.5			V
Reverse current	at $V_R = 8.5 V$	I_R			5	μA
Reverse break down voltage	at $I_R = 1 mA$	V_{BR}	9.5	10.7		V
Clamping voltage	at $I_{PP} = 1 A$	V_C		11.7	14	V
	at $I_{PP} = I_{PPM} = 18 A$	V_C		18.5	22.2	V
Capacitance	at $V_R = 0 V$; $f = 1 MHz$	C_D		80	125	pF
	at $V_R = 4 V$; $f = 1 MHz$	C_D		60		pF

GSOT12C

BiSy mode (between pin 1 to 2 or pin 2 to 1; pin 3 not connected)

Parameter	Test conditions/remarks	Symbol	Min.	Typ.	Max.	Unit
Protection paths	Number of lines which can be protected	N_{lines}			1	lines
Reverse stand off voltage	at $I_R = 1 \mu A$	V_{RWM}	12.5			V
Reverse current	at $V_R = 12.5 V$	I_R			1	μA
Reverse break down voltage	at $I_R = 1 mA$	V_{BR}	13.5	15.7		V
Clamping voltage	at $I_{PP} = 1 A$	V_C		16.4	19.7	V
	at $I_{PP} = I_{PPM} = 12 A$	V_C		23.4	28.1	V
Capacitance	at $V_R = 0 V$; $f = 1 MHz$	C_D		58	75	pF
	at $V_R = 6 V$; $f = 1 MHz$	C_D		36		pF

GSOT15C

BiSy mode (between pin 1 to 2 or pin 2 to 1; pin 3 not connected)

Parameter	Test conditions/remarks	Symbol	Min.	Typ.	Max.	Unit
Protection paths	Number of lines which can be protected	N_{lines}			1	lines
Reverse stand off voltage	at $I_R = 1 \mu A$	V_{RWM}	15.5			V
Reverse current	at $V_R = 15.5 V$	I_R			1	μA
Reverse break down voltage	at $I_R = 1 mA$	V_{BR}	17	18.7		V
Clamping voltage	at $I_{PP} = 1 A$	V_C		20.4	24.5	V
	at $I_{PP} = I_{PPM} = 8 A$	V_C		26.6	30.6	V
Capacitance	at $V_R = 0 V$; $f = 1 MHz$	C_D		45	60	pF
	at $V_R = 7.5 V$; $f = 1 MHz$	C_D		25		pF

GSOT24C

BiSy mode (between pin 1 to 2 or pin 2 to 1; pin 3 not connected)

Parameter	Test conditions/remarks	Symbol	Min.	Typ.	Max.	Unit
Protection paths	Number of lines which can be protected	N_{lines}			1	lines
Reverse stand off voltage	at $I_R = 1 \mu A$	V_{RWM}	24.5			V
Reverse current	at $V_R = 24.5 V$	I_R			1	μA
Reverse break down voltage	at $I_R = 1 mA$	V_{BR}	27.5	30.7		V
Clamping voltage	at $I_{PP} = 1 A$	V_C		34	41	V
	at $I_{PP} = I_{PPM} = 5 A$	V_C		40	48	V
Capacitance	at $V_R = 0 V$; $f = 1 MHz$	C_D		33	40	pF
	at $V_R = 12 V$; $f = 1 MHz$	C_D		18		pF

GSOT36C

BiSy mode (between pin 1 to 2 or pin 2 to 1; pin 3 not connected)

Parameter	Test conditions/remarks	Symbol	Min.	Typ.	Max.	Unit
Protection paths	Number of lines which can be protected	N_{lines}			1	lines
Reverse stand off voltage	at $I_R = 1 \mu A$	V_{RWM}	36.5			V
Reverse current	at $V_R = 36.5 V$	I_R			1	μA
Reverse break down voltage	at $I_R = 1 mA$	V_{BR}	39.5	43.7		V
Clamping voltage	at $I_{PP} = 1 A$	V_C		50	60	V
	at $I_{PP} = I_{PPM} = 3.5 A$	V_C		60	72	V
Capacitance	at $V_R = 0 V$; $f = 1 MHz$	C_D		26	33	pF
	at $V_R = 18 V$; $f = 1 MHz$	C_D		10		pF

Package Dimensions in millimeters (inches): SOT23

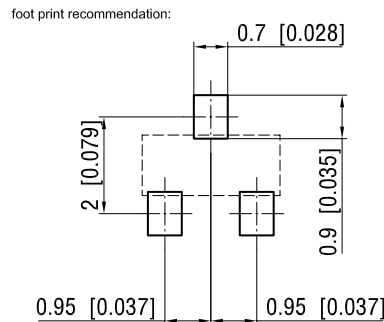
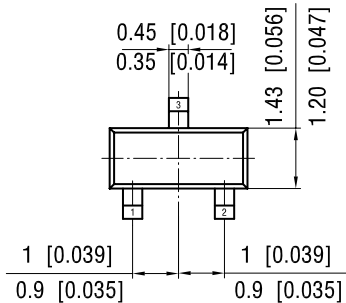
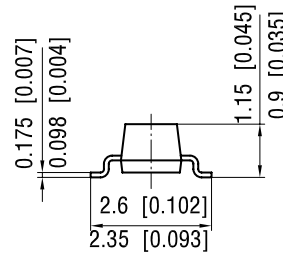
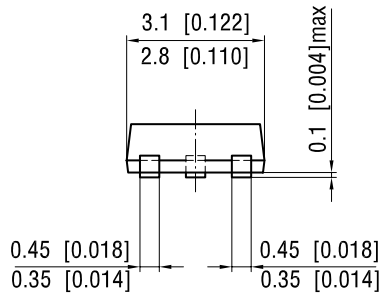

Document no.: 6.541-5014.01-4
Rev. 7 - Date: 08.July.2004
17418

Ozone Depleting Substances Policy Statement

It is the policy of Vishay Semiconductor GmbH to

1. Meet all present and future national and international statutory requirements.
2. Regularly and continuously improve the performance of our products, processes, distribution and operating systems with respect to their impact on the health and safety of our employees and the public, as well as their impact on the environment.

It is particular concern to control or eliminate releases of those substances into the atmosphere which are known as ozone depleting substances (ODSs).

The Montreal Protocol (1987) and its London Amendments (1990) intend to severely restrict the use of ODSs and forbid their use within the next ten years. Various national and international initiatives are pressing for an earlier ban on these substances.

Vishay Semiconductor GmbH has been able to use its policy of continuous improvements to eliminate the use of ODSs listed in the following documents.

1. Annex A, B and list of transitional substances of the Montreal Protocol and the London Amendments respectively.
2. Class I and II ozone depleting substances in the Clean Air Act Amendments of 1990 by the Environmental Protection Agency (EPA) in the USA.
3. Council Decision 88/540/EEC and 91/690/EEC Annex A, B and C (transitional substances) respectively.

Vishay Semiconductor GmbH can certify that our semiconductors are not manufactured with ozone depleting substances and do not contain such substances.

We reserve the right to make changes to improve technical design
and may do so without further notice.

Parameters can vary in different applications. All operating parameters must be validated for each customer application by the customer. Should the buyer use Vishay Semiconductors products for any unintended or unauthorized application, the buyer shall indemnify Vishay Semiconductors against all claims, costs, damages, and expenses, arising out of, directly or indirectly, any claim of personal damage, injury or death associated with such unintended or unauthorized use.

Vishay Semiconductor GmbH, P.O.B. 3535, D-74025 Heilbronn, Germany



Disclaimer

All product specifications and data are subject to change without notice.

Vishay Intertechnology, Inc., its affiliates, agents, and employees, and all persons acting on its or their behalf (collectively, "Vishay"), disclaim any and all liability for any errors, inaccuracies or incompleteness contained herein or in any other disclosure relating to any product.

Vishay disclaims any and all liability arising out of the use or application of any product described herein or of any information provided herein to the maximum extent permitted by law. The product specifications do not expand or otherwise modify Vishay's terms and conditions of purchase, including but not limited to the warranty expressed therein, which apply to these products.

No license, express or implied, by estoppel or otherwise, to any intellectual property rights is granted by this document or by any conduct of Vishay.

The products shown herein are not designed for use in medical, life-saving, or life-sustaining applications unless otherwise expressly indicated. Customers using or selling Vishay products not expressly indicated for use in such applications do so entirely at their own risk and agree to fully indemnify Vishay for any damages arising or resulting from such use or sale. Please contact authorized Vishay personnel to obtain written terms and conditions regarding products designed for such applications.

Product names and markings noted herein may be trademarks of their respective owners.