

PROTECTION PRODUCTS

Description

The LC03-3.3 transient voltage suppressor is designed to protect components which are connected to high speed data and telecommunication lines from voltage surges caused by **lightning**, electrostatic discharge (**ESD**), and electrical fast transients (**EFT**).

TVS diodes are ideal for use as board level protection of sensitive semiconductor components. The LC03-3.3 combines a TVS diode with a rectifier bridge to provide transient protection in both common and differential mode with a single device. The LC03-3.3 utilizes Semtech's EPD technology for superior electrical characteristics at 3.3 volts. The capacitance of the device is minimized to ensure correct signal transmission on high speed lines.

The LC03-3.3 meets the short-haul (intra-building) transient immunity requirements of Bellcore 1089 for telecommunications applications.

Features

- ◆ 1800 watts peak pulse power ($t_p = 8/20\mu s$)
- ◆ Transient protection for high-speed data lines to **Bellcore 1089 (Intra-Building) 100A (2/10 μs)**
ITU K.20 $I_{pp} = 40A (5/310\mu s)$
IEC 61000-4-2 (ESD) $\pm 15kV$ (air), $\pm 8kV$ (contact)
IEC 61000-4-4 (EFT) 40A (5/50ns)
IEC 61000-4-5 (Lightning) 100A (8/20 μs)
- ◆ Protects two lines in common and differential mode
- ◆ Low capacitance for high-speed interfaces
- ◆ Low operating voltage (3.3V)
- ◆ Low clamping voltage
- ◆ Integrated structure saves board space and increases reliability
- ◆ Solid-state EPD technology

Mechanical Characteristics

- ◆ JEDEC SO-8 package
- ◆ RoHS/WEEE Compliant
- ◆ Molding compound flammability rating: UL 94V-0
- ◆ Marking : Part number, date code
- ◆ Packaging : Tube or Tape and Reel per EIA 481

Applications

- ◆ Low Voltage Interfaces
- ◆ T3/E3
- ◆ 10/100 Ethernet
- ◆ Set-Top Box
- ◆ ISDN Interfaces

Circuit Diagram

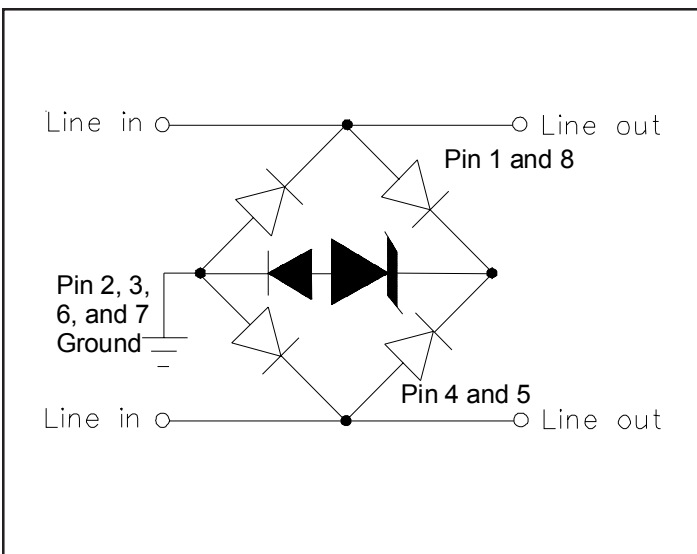

Schematic & PIN Configuration

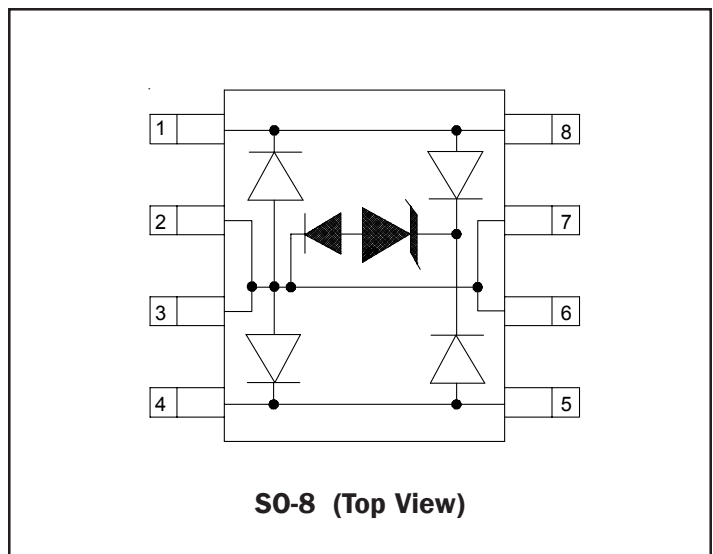

PROTECTION PRODUCTS
Absolute Maximum Rating

Rating	Symbol	Value	Units
Peak Pulse Power ($t_p = 8/20\mu s$)	P_{pk}	1800	Watts
Peak Pulse Current ($t_p = 8/20\mu s$)	I_{pp}	100	A
Lead Soldering Temperature	T_L	260 (10 sec.)	°C
Operating Temperature	T_J	-55 to +125	°C
Storage Temperature	T_{STG}	-55 to +150	°C

Electrical Characteristics

LC03-3.3						
Parameter	Symbol	Conditions	Minimum	Typical	Maximum	Units
Reverse Stand-Off Voltage	V_{RWM}				3.3	V
Punch-Through Voltage	V_{PT}	$I_{PT} = 2\mu A$	3.5			V
Snap-Back Voltage	V_{SB}	$I_{SB} = 50mA$	2.8			V
Reverse Leakage Current	I_R	$V_{RWM} = 3.3V, T=25^\circ C$			1	μA
Clamping Voltage	V_C	$I_{pp} = 50A, t_p = 8/20\mu s$ Line-to-Ground			11.5	V
Clamping Voltage	V_C	$I_{pp} = 50A, t_p = 8/20\mu s$ Line-to-Line			13.5	V
Clamping Voltage	V_C	$I_{pp} = 100A, t_p = 8/20\mu s$ Line-to-Ground			15	V
Clamping Voltage	V_C	$I_{pp} = 100A, t_p = 8/20\mu s$ Line-to-Line			18	V
Junction Capacitance	C_J	Between I/O pins and Ground $V_R = 0V, f = 1MHz$		16	25	pF
		Between I/O pins $V_R = 0V, f = 1MHz$		8	12	pF

PROTECTION PRODUCTS

Typical Characteristics

Non-Repetitive Peak Pulse Power vs. Pulse Time

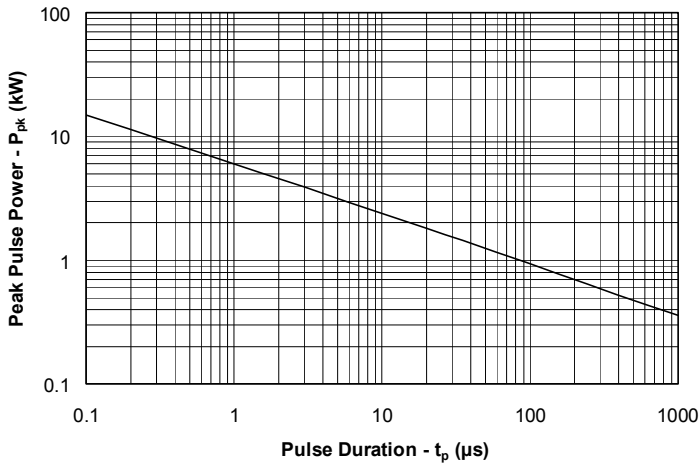

Power Derating Curve

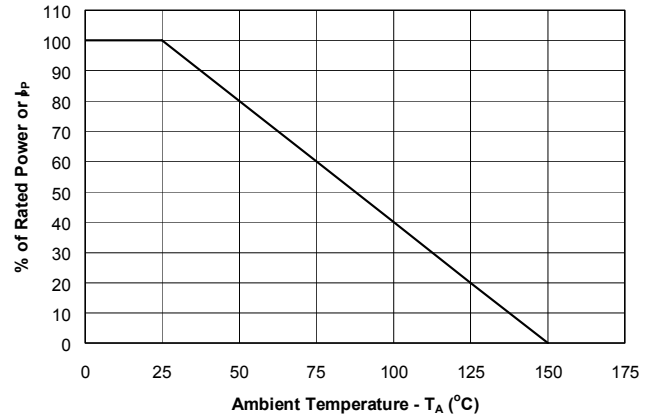

Pulse Waveform

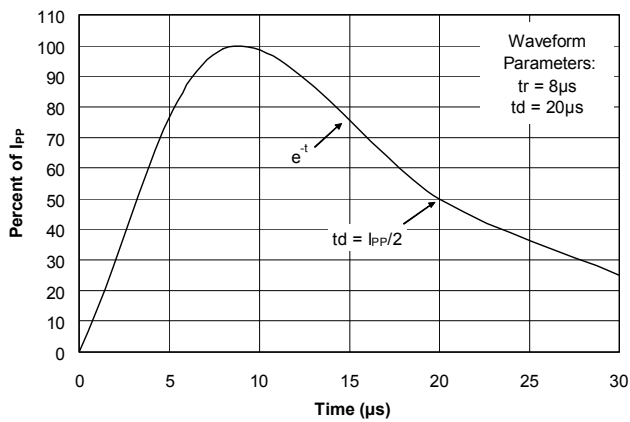

Clamping Voltage vs. Peak Pulse Current

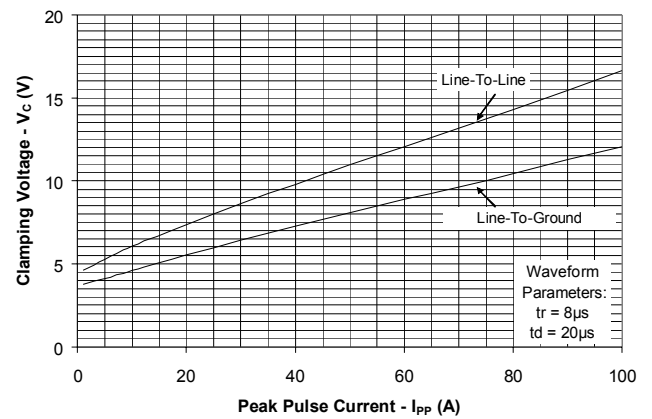

Normalized Capacitance vs. Reverse Voltage

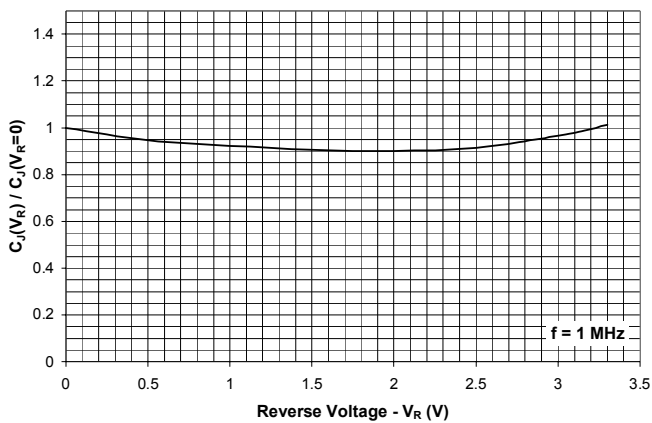

Insertion Loss S21 (Line to Ground)

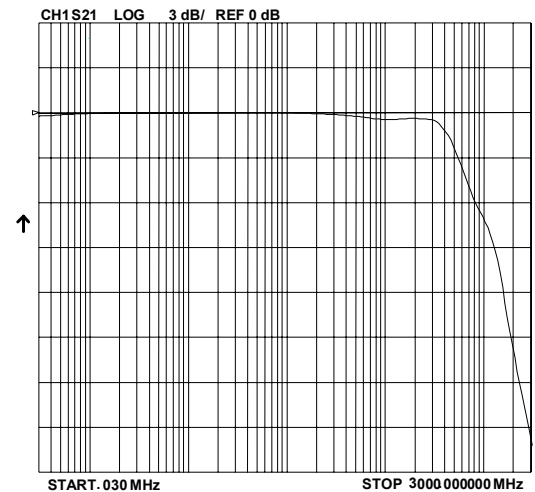

PROTECTION PRODUCTS

Applications Information

Device Connection Options for Protection of Two High-Speed Data Lines

The LC03-3.3 is designed to protect two high-speed data lines (one differential pair) from transient over-voltages which result from lightning and ESD. The device can be configured to protect in differential (Line-to-Line) and common (Line-to-Ground) mode. Data line inputs/outputs are connected at pins 1 to 8, and 4 to 5 as shown. Pins 2, 3, 6, and 7 are connected to ground. These pins should be connected directly to a ground plane on the board for best results. The path length is kept as short as possible to minimize parasitic inductance. In applications where high common mode voltages are present, differential protection is achieved by leaving pins 2, 3, 6, and 7 not connected.

Matte Tin Lead Finish

Matte tin has become the industry standard lead-free replacement for SnPb lead finishes. A matte tin finish is composed of 100% tin solder with large grains. Since the solder volume on the leads is small compared to the solder paste volume that is placed on the land pattern of the PCB, the reflow profile will be determined by the requirements of the solder paste. Therefore, these devices are compatible with both lead-free and SnPb assembly techniques. In addition, unlike other lead-free compositions, matte tin does not have any added alloys that can cause degradation of the solder joint.

Connection for Differential (Line-to-Line) and Common Mode Protection (Line-to-Ground)

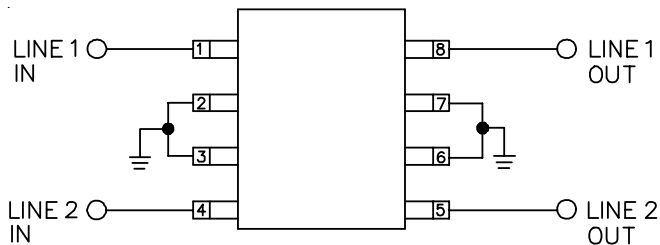

Connection for Differential Protection (Line-to-Line)

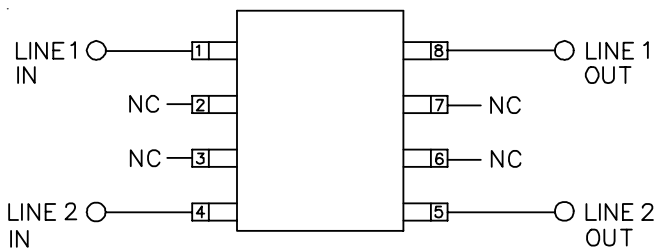

PROTECTION PRODUCTS

Applications Information - SPICE Model

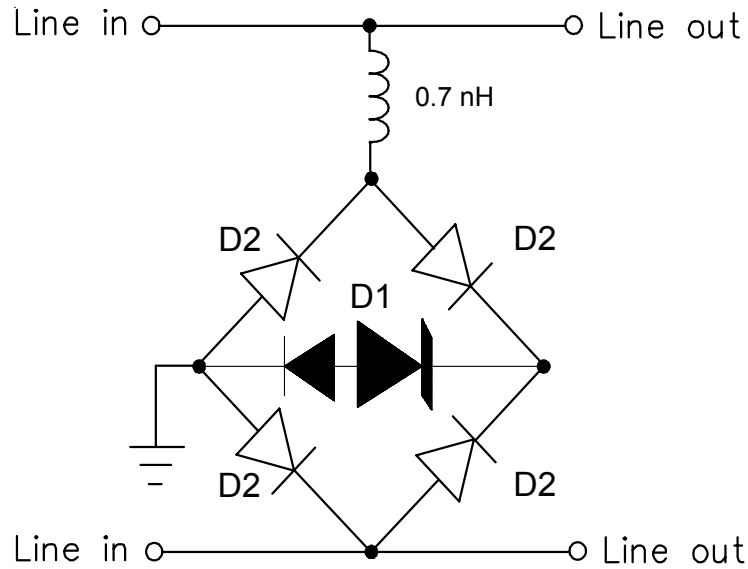

LC03-3.3 Spice Model

LC03-3.3 Spice Parameters			
Parameter	Unit	D1 (TVS)	D2 (LCRD)
IS	Amp	1.0E-20	3.98E-13
BV	Volt	3.5	240
VJ	Volt	13.8	0.64
RS	Ohm	0.0257	0.048
IBV	Amp	1E-3	1E-3
CJO	Farad	3.4e-9	8.0E-12
TT	sec	2.541E-9	2.541E-9
M	-	0.145	0.022
N	-	1.1	1.1
EG	eV	1.11	1.11

PROTECTION PRODUCTS

Outline Drawing - S0-8

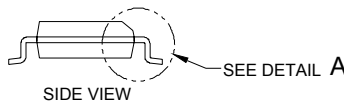
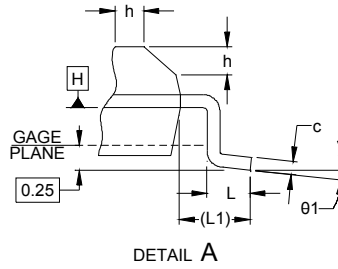
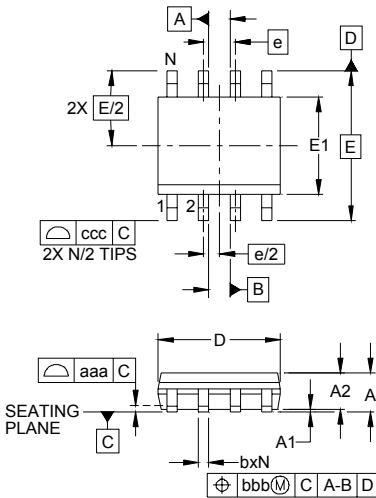

DIM	INCHES			MILLIMETERS		
	MIN	NOM	MAX	MIN	NOM	MAX
A	.053	-	.069	1.35	-	1.75
A1	.004	-	.010	0.10	-	0.25
A2	.049	-	.065	1.25	-	1.65
b	.012	-	.020	0.31	-	0.51
c	.007	-	.010	0.17	-	0.25
D	.189	.193	.197	4.80	4.90	5.00
E1	.150	.154	.157	3.80	3.90	4.00
E	.236 BSC			6.00 BSC		
e	.050 BSC			1.27 BSC		
h	.010	-	.020	0.25	-	0.50
L	.016	.028	.041	0.40	0.72	1.04
L1	(0.041)			(1.04)		
N	8			8		
theta1	0°	-	8°	0°	-	8°
aaa	.004			0.10		
bbb	.010			0.25		
ccc	.008			0.20		

NOTES:

1. CONTROLLING DIMENSIONS ARE IN MILLIMETERS (ANGLES IN DEGREES).
2. DATUMS **-A-** AND **-B-** TO BE DETERMINED AT DATUM PLANE **-H-**
3. DIMENSIONS "E1" AND "D" DO NOT INCLUDE MOLD FLASH, PROTRUSIONS OR GATE BURRS.
4. REFERENCE JEDEC STD MS-012, VARIATION AA.

Land Pattern -S0-8

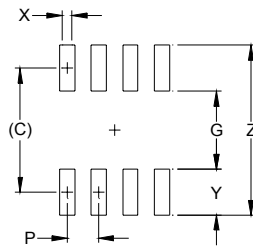

DIMENSIONS		
DIM	INCHES	MILLIMETERS
C	(.205)	(5.20)
G	.118	3.00
P	.050	1.27
X	.024	0.60
Y	.087	2.20
Z	.291	7.40

NOTES:

1. THIS LAND PATTERN IS FOR REFERENCE PURPOSES ONLY. CONSULT YOUR MANUFACTURING GROUP TO ENSURE YOUR COMPANY'S MANUFACTURING GUIDELINES ARE MET.
2. REFERENCE IPC-SM-782A, RLP NO. 300A.

PROTECTION PRODUCTS

Ordering Information

Part Number	Lead Finish	Qty per Reel	Reel Size
LC03-3.3.TB	SnPb	500	7 Inch
LC03-3.3.TBT	Pb Free	500	7 Inch

Marking Diagram

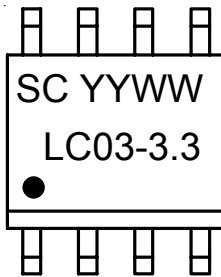

Note:
YYWW = Date Code

Contact Information

Semtech Corporation
 Protection Products Division
 200 Flynn Road, Camarillo, CA 93012
 Phone: (805)498-2111 FAX (805)498-3804