

LMC7101/LMC7101Q

Tiny Low Power Operational Amplifier with Rail-to-Rail Input and Output

General Description

The LMC7101 is a high performance CMOS operational amplifier available in the space saving 5-Pin SOT23 Tiny package. This makes the LMC7101 ideal for space and weight critical designs. The performance is similar to a single amplifier of the LMC6482/LMC6484 type, with rail-to-rail input and output, high open loop gain, low distortion, and low supply currents.

The main benefits of the Tiny package are most apparent in small portable electronic devices, such as mobile phones, pagers, notebook computers, personal digital assistants, and PCMCIA cards. The tiny amplifiers can be placed on a board where they are needed, simplifying board layout.

Features

- Tiny 5-Pin SOT23 package saves space—typical circuit layouts take half the space of 8-Pin SOIC designs
- Guaranteed specs at 2.7V, 3V, 5V, 15V supplies
- Typical supply current 0.5 mA at 5V
- Typical total harmonic distortion of 0.01% at 5V
- 1.0 MHz gain-bandwidth
- Similar to popular LMC6482/LMC6484
- Rail-to-rail input and output
- Temperature Range -40°C to 125°C (LMC7101Q)

Applications

- Mobile communications
- Notebooks and PDAs
- Battery powered products
- Sensor interface
- Automotive applications (LMC7101Q)

Connection Diagram

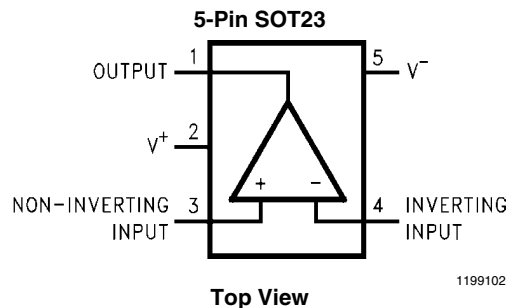

Ordering Information

Package	Part Number	Package Marking	Transport Media	NSC Drawing	Features
5-Pin SOT23	LMC7101AIM5	A00A	1k Units on Tape and Reel	MF05A	
	LMC7101AIM5X		3k Units Tape and Reel		
	LMC7101BIM5	A00B	1k Units on Tape and Reel		
	LMC7101BIM5X		3k Units Tape and Reel		
	LMC7101QM5	AT6A	1k Units on Tape and Reel		
	LMC7101QM5X		3k Units Tape and Reel		

* The LMC7101Q incorporates enhanced manufacturing and support processes for the automotive market, including defect detection methodologies.

Absolute Maximum Ratings (Note 1)

If Military/Aerospace specified devices are required, please contact the National Semiconductor Sales Office/Distributors for availability and specifications.

ESD Tolerance (Note 2)	
Human Body Model	1000V
Machine Model	200V
Charged Device Model	1000V
Difference Input Voltage	±Supply Voltage
Voltage at Input/Output Pin	(V+) + 0.3V, (V-) - 0.3V
Supply Voltage (V+ - V-)	16V
Current at Input Pin	±5 mA
Current at Output Pin (Note 3)	±35 mA
Current at Power Supply Pin	35 mA

Lead Temp. (Soldering, 10 sec.)	260°C
Storage Temperature Range	-65°C to +150°C
Junction Temperature (Note 4)	150°C

Recommended Operating Conditions (Note 1)

Supply Voltage	2.7V ≤ V+ ≤ 15.5V
Temperature Range	
LMC7101AI, LMC7101BI	-40°C to 85°C
LMC7101Q	-40°C to 125°C
Thermal Resistance (θ _{JA})	
5-Pin SOT23	325°C/W

2.7V Electrical Characteristics

Unless otherwise specified, all limits guaranteed for T_J = 25°C, V+ = 2.7V, V- = 0V, V_{CM} = V_O = V+/2 and R_L > 1 MΩ. **Boldface** limits apply at the temperature extremes.

Symbol	Parameter	Conditions	Typ (Note 5)	LMC7101AI Limit (Note 6)	LMC7101BI Limit (Note 6)	LMC7101Q Limit (Notes 6, 10)	Units
V _{OS}	Input Offset Voltage Average Drift	V+ = 2.7V	0.11	6	9	9	mV max
TCV _{OS}	Input Offset Voltage		1				μV/°C
I _B	Input Bias Current		1.0	64	64	1000	pA max
I _{OS}	Input Offset Current		0.5	32	32	2000	pA max
R _{IN}	Input Resistance		>1				Tera Ω
CMRR	Common-Mode Rejection Ratio	0V ≤ V _{CM} ≤ 2.7V V+ = 2.7V	70	55	50	50	dB min
V _{CM}	Input Common Mode Voltage Range	For CMRR ≥ 50 dB	0.0	0.0	0.0	0.0	V min
			3.0	2.7	2.7	2.7	V max
PSRR	Power Supply Rejection Ratio	V+ = 1.35V to 1.65V V- = -1.35V to -1.65V V _{CM} = 0	60	50	45	45	dB min
C _{IN}	Common-Mode Input Capacitance		3				pF
V _O	Output Swing	R _L = 2 kΩ	2.45	2.15	2.15	2.15	V min
			0.25	0.5	0.5	0.5	V max
		R _L = 10 kΩ	2.68	2.64	2.64	2.64	V min
			0.025	0.06	0.06	0.06	V max
I _S	Supply Current		0.5	0.81 0.95	0.81 0.95	0.81 0.95	mA max
SR	Slew Rate (Note 8)		0.7				V/μs
GBW	Gain-Bandwidth Product		0.6				MHz

3V DC Electrical Characteristics

Unless otherwise specified, all limits guaranteed for $T_J = 25^\circ\text{C}$, $V^+ = 3\text{V}$, $V^- = 0\text{V}$, $V_{\text{CM}} = 1.5\text{V}$, $V_O = V^+/2$ and $R_L = 1\text{M}\Omega$. **Bold-face** limits apply at the temperature extremes.

Symbol	Parameter	Conditions	Typ (Note 5)	LMC7101AI Limit (Note 6)	LMC7101BI Limit (Note 6)	LMC7101Q Limit (Notes 6, 10)	Units
V_{OS}	Input Offset Voltage		0.11	4 6	7 9	7	mV max
TCV_{OS}	Input Offset Voltage Average Drift		1				$\mu\text{V}/^\circ\text{C}$
I_B	Input Current		1.0	64	64	1000	pA max
I_{OS}	Input Offset Current		0.5	32	32	2000	pA max
R_{IN}	Input Resistance		>1				Tera Ω
CMRR	Common-Mode Rejection Ratio	$0\text{V} \leq V_{\text{CM}} \leq 3\text{V}$ $V^+ = 3\text{V}$	74	64	60	60	db min
V_{CM}	Input Common-Mode Voltage Range	For CMRR $\geq 50\text{ dB}$	0.0	0.0	0.0	0.0	V min
			3.3	3.0	3.0	3.0	V max
PSRR	Power Supply Rejection Ratio	$V^+ = 1.5\text{V to } 7.5\text{V}$ $V^- = -1.5\text{V to } -7.5\text{V}$ $V_O = V_{\text{CM}} = 0$	80	68	60	60	dBmin
C_{IN}	Common-Mode Input Capacitance		3				pF
V_O	Output Swing	$R_L = 2\text{ k}\Omega$	2.8	2.6	2.6	2.6	V min
			0.2	0.4	0.4	0.4	V max
		$R_L = 600\Omega$	2.7	2.5	2.5	2.5	V min
			0.37	0.6	0.6	0.6	V max
I_S	Supply Current		0.5	0.81 0.95	0.81 0.95	0.81 0.95	mA max

5V DC Electrical Characteristics

Unless otherwise specified, all limits guaranteed for $T_J = 25^\circ\text{C}$, $V^+ = 5\text{V}$, $V^- = 0\text{V}$, $V_{\text{CM}} = 1.5\text{V}$, $V_O = V^+/2$ and $R_L = 1\text{M}\Omega$. **Boldface** limits apply at the temperature extremes.

Symbol	Parameter	Conditions	Typ (Note 5)	LMC7101AI Limit (Note 6)	LMC7101BI Limit (Note 6)	LMC7101Q Limit (Notes 6, 10)	Units	
V_{OS}	Input Offset Voltage	$V^+ = 5\text{V}$	0.11	3 5	7 9	7 9	mV max	
TCV_{OS}	Input Offset Voltage Average Drift		1.0				$\mu\text{V}/^\circ\text{C}$	
I_{B}	Input Current		1	64	64	1000	pA max	
I_{OS}	Input Offset Current		0.5	32	32	2000	pA max	
R_{IN}	Input Resistance		>1				Tera Ω	
CMRR	Common-Mode Rejection Ratio	$0\text{V} \leq V_{\text{CM}} \leq 5\text{V}$ LMC7101Q @ 125°C $0.2\text{V} \leq V_{\text{CM}} \leq 4.8\text{V}$	82	65 60	60 55	60 55	dB min	
+PSRR	Positive Power Supply Rejection Ratio	$V^+ = 5\text{V}$ to 15V $V^- = 0\text{V}$, $V_O = 1.5\text{V}$	82	70 65	65 62	65 62	dB min	
-PSRR	Negative Power Supply Rejection Ratio	$V^- = -5\text{V}$ to -15V $V^+ = 0\text{V}$, $V_O = -1.5\text{V}$	82	70 65	65 62	65 62	dB min	
V_{CM}	Input Common-Mode Voltage Range	For CMRR $\geq 50\text{ dB}$	-0.3	-0.20 0.00	-0.20 0.00	-0.2 0.2	V min	
			5.3	5.20 5.00	5.20 5.00	5.2 4.8	V max	
C_{IN}	Common-Mode Input Capacitance		3				pF	
V_O	Output Swing	$R_L = 2\text{ k}\Omega$		4.9	4.7 4.6	4.7 4.6	4.7 4.54	V min
				0.1	0.18 0.24	0.18 0.24	0.18 0.28	V max
		$R_L = 600\Omega$		4.7	4.5 4.24	4.5 4.24	4.5 4.28	V min
				0.3	0.5 0.65	0.5 0.65	0.5 0.8	V max
I_{SC}	Output Short Circuit Current	$V_O = 0\text{V}$ 24	Sourcing	24	16 11	16 11	16 9	mA min
		$V_O = 5\text{V}$	Sinking	19	11 7.5	11 7.5	11 5.8	mA min
I_{S}	Supply Current		0.5	0.85 1.0	0.85 1.0	0.85 1.0	mA max	

5V AC Electrical Characteristics

Unless otherwise specified, all limits guaranteed for $T_J = 25^\circ\text{C}$, $V^+ = 5\text{V}$, $V^- = 0\text{V}$, $V_{\text{CM}} = 1.5\text{V}$, $V_O = V^+/2$ and $R_L = 1\text{M}\Omega$. **Boldface** limits apply at the temperature extremes.

Symbol	Parameter	Conditions	Typ (Note 5)	LMC7101AI Limit (Note 6)	LMC7101BI Limit (Note 6)	Units
THD	Total Harmonic Distortion	$f = 10\text{ kHz}$, $A_V = -2$ $R_L = 10\text{ k}\Omega$, $V_O = 4.0\text{ V}_{\text{PP}}$	0.01			%
SR	Slew Rate		1.0			$\text{V}/\mu\text{s}$
GBW	Gain Bandwidth Product		1.0			MHz

15V DC Electrical Characteristics

Unless otherwise specified, all limits guaranteed for $T_J = 25^\circ\text{C}$, $V^+ = 15\text{V}$, $V^- = 0\text{V}$, $V_{\text{CM}} = 1.5\text{V}$, $V_O = V^+/2$ and $R_L = 1\text{M}\Omega$.

Boldface limits apply at the temperature extremes.

Symbol	Parameter	Conditions	Typ (Note 5)	LMC7101AI Limit (Note 6)	LMC7101BI Limit (Note 6)	LMC7101Q Limit (Notes 6, 10)	Units	
V_{OS}	Input Offset Voltage		0.11				mV max	
TCV_{OS}	Input Offset Voltage Average Drift		1.0				$\mu\text{V}/^\circ\text{C}$	
I_{B}	Input Current		1.0	64	64	1000	pA max	
I_{OS}	Input Offset Current		0.5	32	32	2000	pA max	
R_{IN}	Input Resistance		>1				Tera Ω	
CMRR	Common-Mode Rejection Ratio	$0\text{V} \leq V_{\text{CM}} \leq 15\text{V}$	82	70	65	65	dB min	
		LMC7101Q @ 125°C $0.2\text{V} \leq V_{\text{CM}} \leq 14.8\text{V}$		65	60	60		
+PSRR	Positive Power Supply Rejection Ratio	$V^+ = 5\text{V}$ to 15V $V^- = 0\text{V}$, $V_O = 1.5\text{V}$	82	70 65	65 62	65 62	dB min	
-PSRR	Negative Power Supply Rejection Ratio	$V^- = -5\text{V}$ to -15V $V^+ = 0\text{V}$, $V_O = -1.5\text{V}$	82	70 65	65 62	65 62	dB min	
V_{CM}	Input Common-Mode Voltage Range	$V^+ = 5\text{V}$	-0.3	-0.20 0.00	-0.20 0.00	-0.2 0.2	V min	
		For $\text{CMRR} \geq 50\text{ dB}$	15.3	15.20 15.00	15.20 15.00	15.2 14.8	V max	
A_{V}	Large Signal Voltage Gain (Note 7)	$R_L = 2\text{ k}\Omega$	Sourcing	340	80 40	80 40	80 30	V/mV
			Sinking	24	15 10	15 10	15 4	
		$R_L = 600\Omega$	Sourcing	300	34	34	34	V/mV
			Sinking	15	6	6	6	
C_{IN}	Input Capacitance		3				pF	
V_O	Output Swing	$V^+ = 15\text{V}$ $R_L = 2\text{ k}\Omega$		14.7	14.4 14.2	14.4 14.2	14.4 14.2	V min
				0.16	0.32 0.45	0.32 0.45	0.32 0.45	V max
		$V^+ = 15\text{V}$ $R_L = 600\Omega$		14.1	13.4 13.0	13.4 13.0	13.4 12.85	V min
				0.5	1.0 1.3	1.0 1.3	1.0 1.5	V max
I_{SC}	Output Short Circuit Current (Note 9)	$V_O = 0\text{V}$	Sourcing	50	30 20	30 20	30 20	mA min
		$V_O = 12\text{V}$	Sinking	50	30 20	30 20	30 20	
I_{S}	Supply Current		0.8	1.50 1.71	1.50 1.71	1.50 1.75	mA max	

15V AC Electrical Characteristics

Unless otherwise specified, all limits guaranteed for $T_J = 25^\circ\text{C}$, $V^+ = 15\text{V}$, $V^- = 0\text{V}$, $V_{\text{CM}} = 1.5\text{V}$, $V_O = V^+/2$ and $R_L = 1\text{ M}\Omega$.

Boldface limits apply at the temperature extremes.

Symbol	Parameter	Conditions	Typ (Note 5)	LMC7101AI Limit (Note 6)	LMC7101BI Limit (Note 6)	LMC7101Q Limit (Notes 6, 10)	Units
SR	Slew Rate (Note 8)	$V^+ = 15\text{V}$	1.1	0.5 0.4	0.5 0.4	0.5 0.4	$\text{V}/\mu\text{s}$ min
GBW	Gain-Bandwidth Product	$V^+ = 15\text{V}$	1.1				MHz
ϕ_m	Phase Margin		45				deg
G_m	Gain Margin		10				dB
e_n	Input-Referred Voltage Noise	$f = 1\text{ kHz}$, $V_{\text{CM}} = 1\text{V}$	37				$\frac{\text{nV}}{\sqrt{\text{Hz}}}$
i_n	Input-Referred Current Noise	$f = 1\text{ kHz}$	1.5				$\frac{\text{fA}}{\sqrt{\text{Hz}}}$
THD	Total Harmonic Distortion	$f = 10\text{ kHz}$, $A_V = -2$ $R_L = 10\text{ k}\Omega$, $V_O = 8.5\text{ V}_{\text{PP}}$	0.01				%

Note 1: Absolute Maximum Ratings indicate limits beyond which damage to the device may occur. Operating Ratings indicate conditions for which the device is intended to be functional, but specific performance is not guaranteed. For guaranteed specifications and the test conditions, see the Electrical Characteristics.

Note 2: Human Body Model is $1.5\text{ k}\Omega$ in series with 100 pF .

Note 3: Applies to both single-supply and split-supply operation. Continuous short operation at elevated ambient temperature can result in exceeding the maximum allowed junction temperature at 150°C .

Note 4: The maximum power dissipation is a function of $T_{\text{J(MAX)}}$, θ_{JA} and T_{A} . The maximum allowable power dissipation at any ambient temperature is $P_{\text{D}} = (T_{\text{J(MAX)}} - T_{\text{A}})/\theta_{\text{JA}}$. All numbers apply for packages soldered directly into a PC board.

Note 5: Typical Values represent the most likely parametric norm.

Note 6: All limits are guaranteed by testing or statistical analysis.

Note 7: $V^+ = 15\text{V}$, $V_{\text{CM}} = 1.5\text{V}$ and R_L connect to 7.5V . For sourcing tests, $7.5\text{V} \leq V_O \leq 12.5\text{V}$. For sinking tests, $2.5\text{V} \leq V_O \leq 7.5\text{V}$.

Note 8: $V^+ = 15\text{V}$. Connected as a voltage follower with a 10V step input. Number specified is the slower of the positive and negative slew rates. $R_L = 100\text{ k}\Omega$ connected to 7.5V . Amp excited with 1 kHz to produce $V_O = 10\text{ V}_{\text{PP}}$.

Note 9: Do not short circuit output to V^+ when V^+ is greater than 12V or reliability will be adversely affected.

Note 10: When operated at temperature between -40°C and 85°C , the LMC7101Q will meet LMC7101BI specifications.

2.7V Typical Performance Characteristics

$V^+ = 2.7V$, $V^- = 0V$, $T_A = 25^\circ C$, unless otherwise specified.

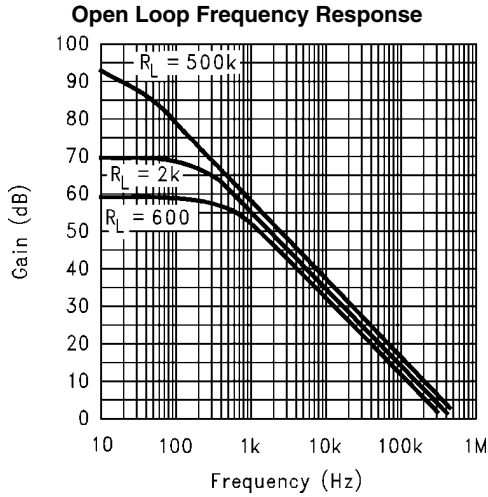

1199116

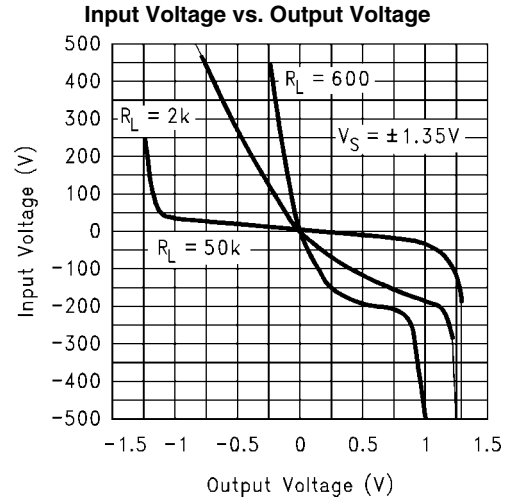

1199117

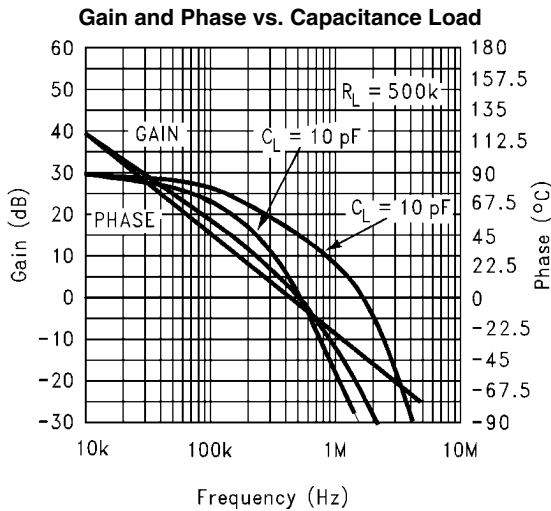

1199118

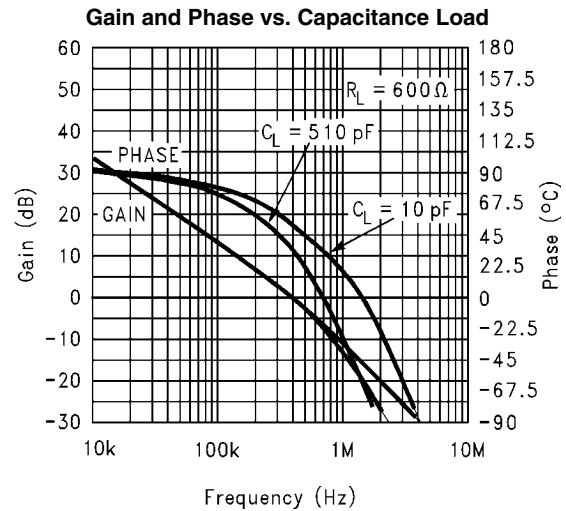

1199119

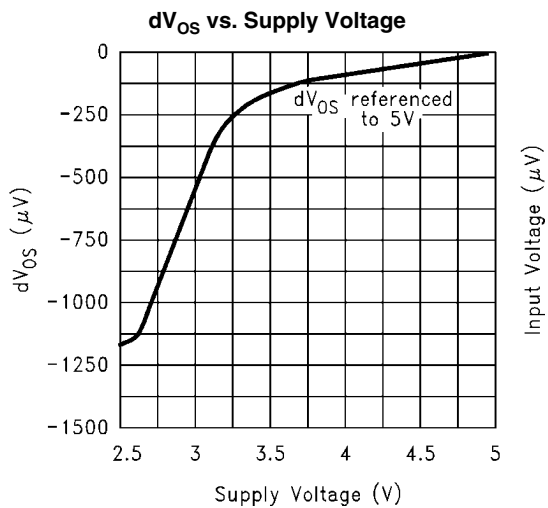

1199120

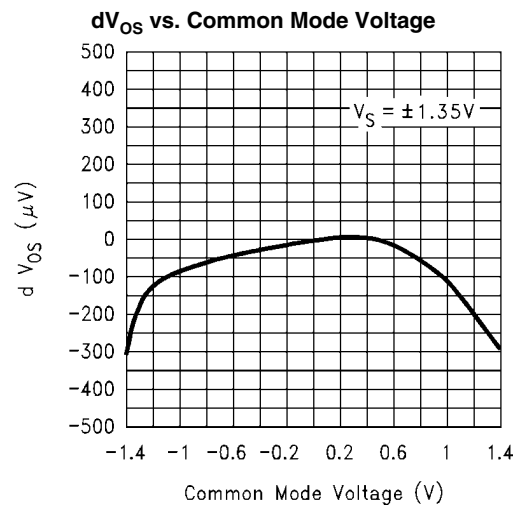

1199121

Sinking Current vs. Output Voltage

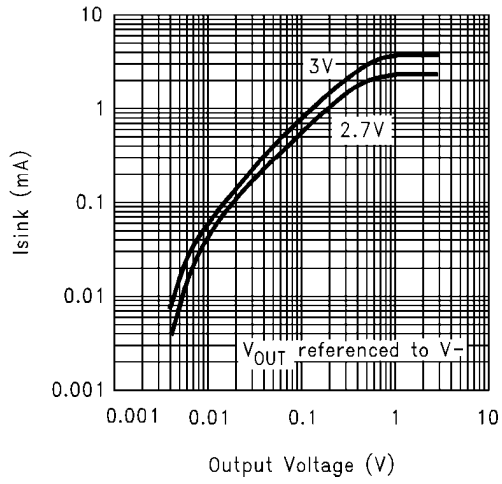

1199122

Sourcing Current vs. Output Voltage

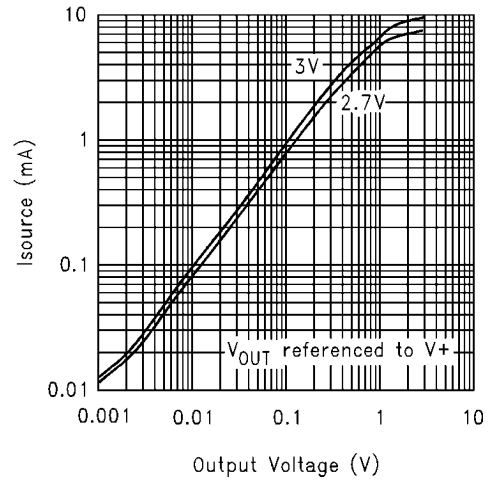

1199123

3V Typical Performance Characteristics

$V^+ = 3V$, $V^- = 0V$, $T_A = 25^\circ C$, unless otherwise specified.

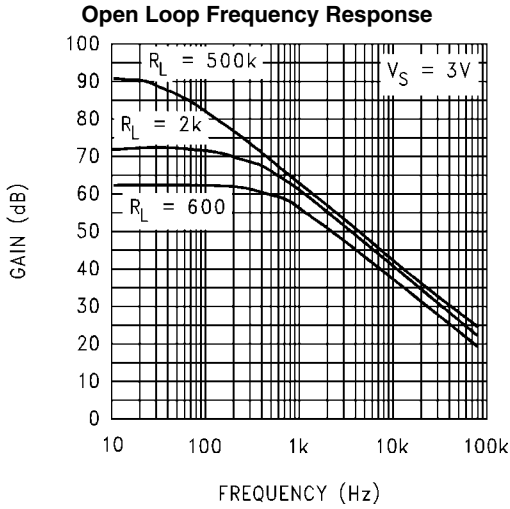

1199124

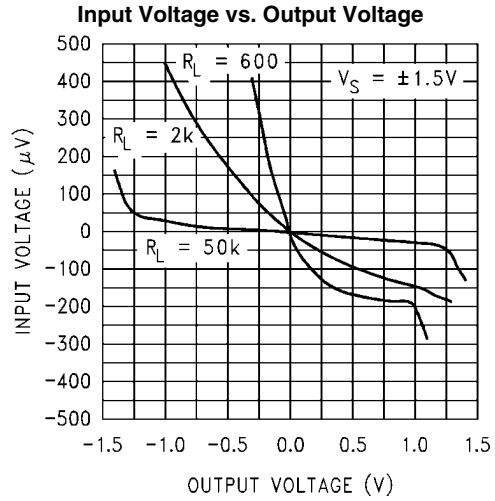

1199125

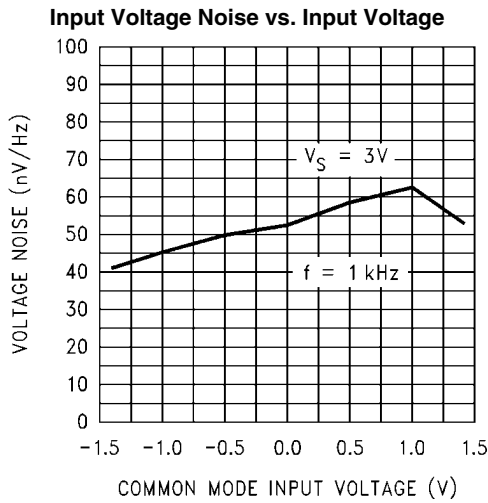

1199126

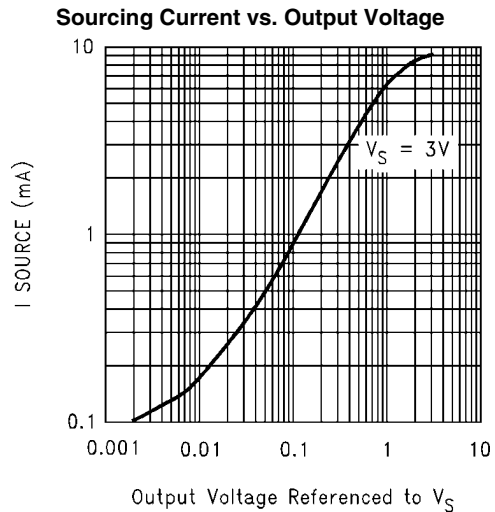

1199127

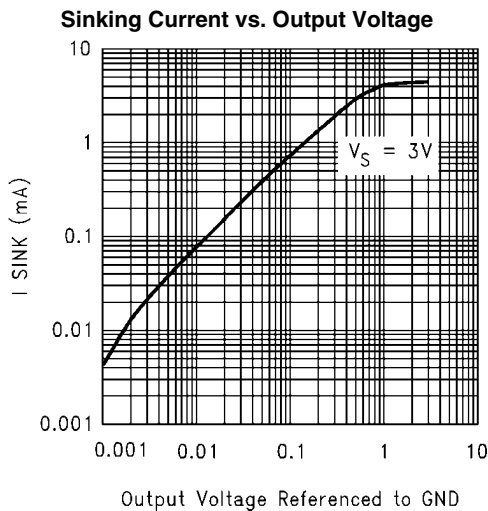

1199128

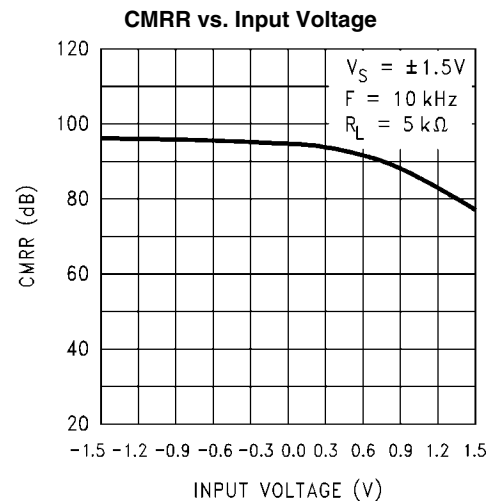

1199129

5V Typical Performance Characteristics $V^+ = 5V, V^- = 0V, T_A = 25^\circ C$, unless otherwise specified.

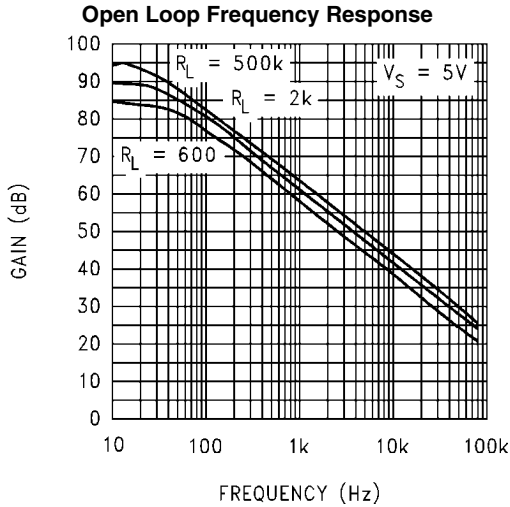

1199130

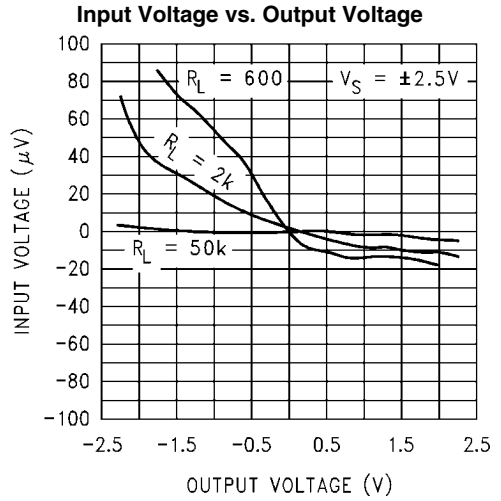

1199131

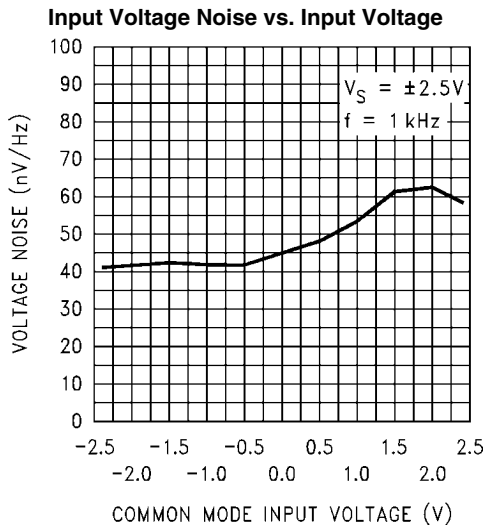

1199132

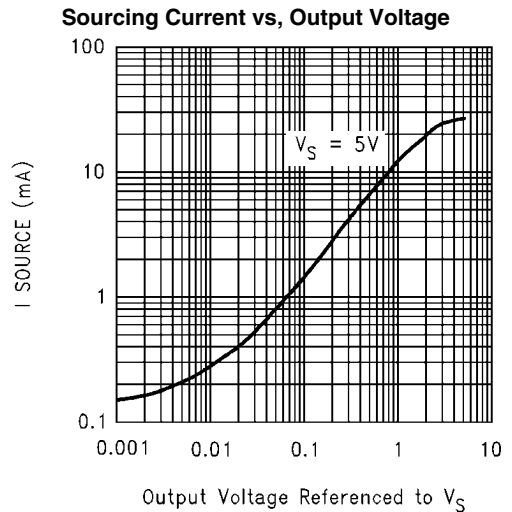

1199133

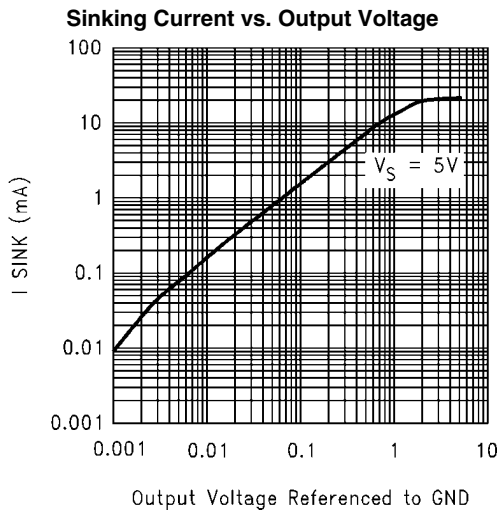

1199134

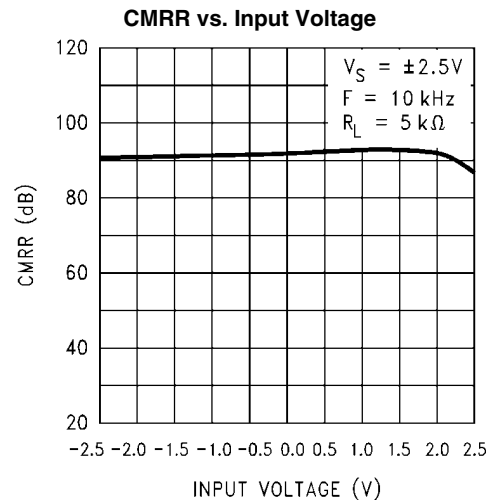

1199135

15V Typical Performance Characteristics

$V^+ = +15V$, $V^- = 0V$, $T_A = 25^\circ C$, unless otherwise specified.

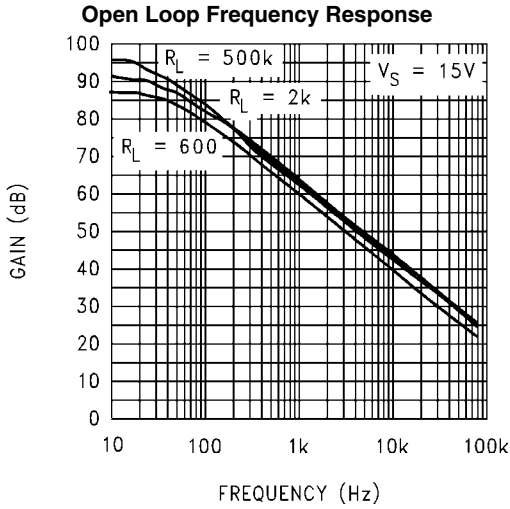

1199136

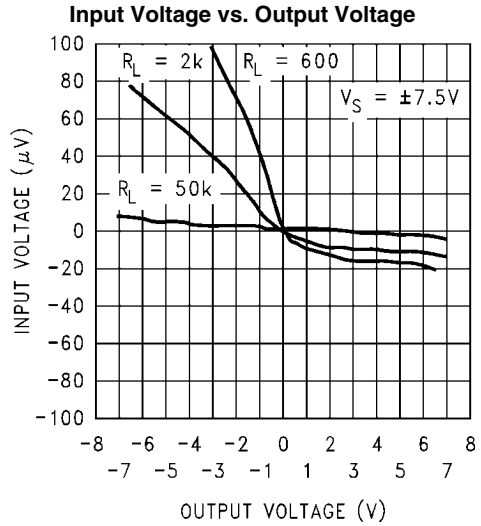

1199137

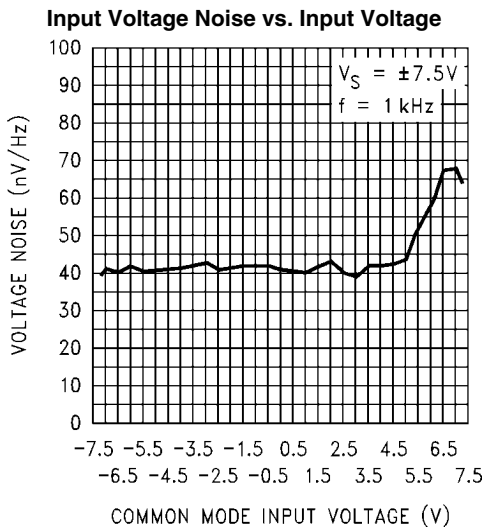

1199138

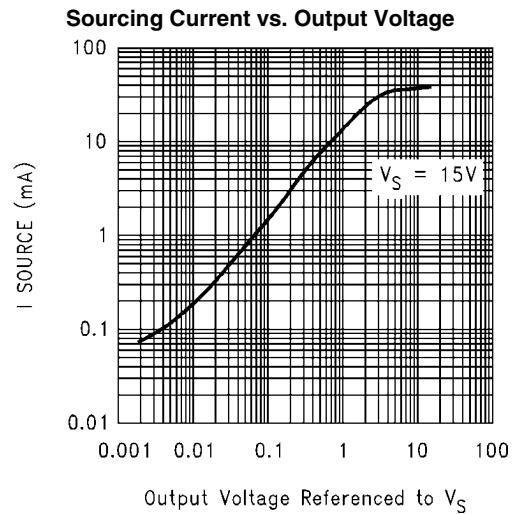

1199139

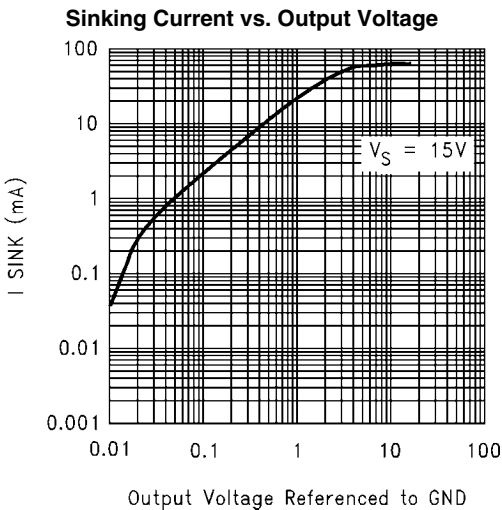

1199140

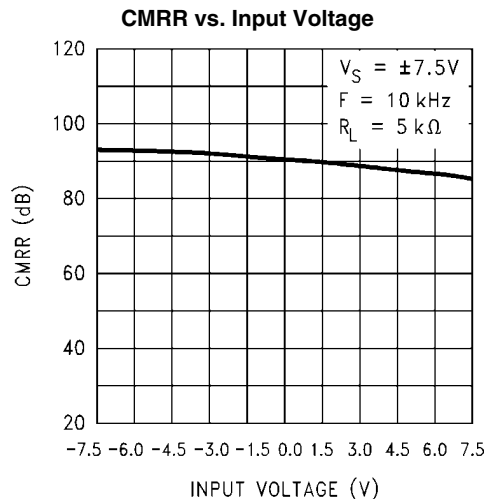

1199141

Supply Current vs. Supply Voltage

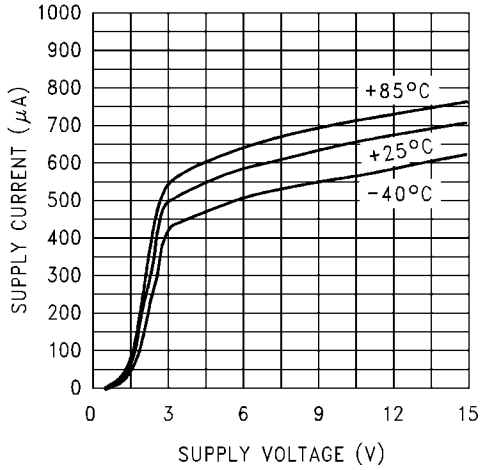

1199142

Input Current vs. Temperature

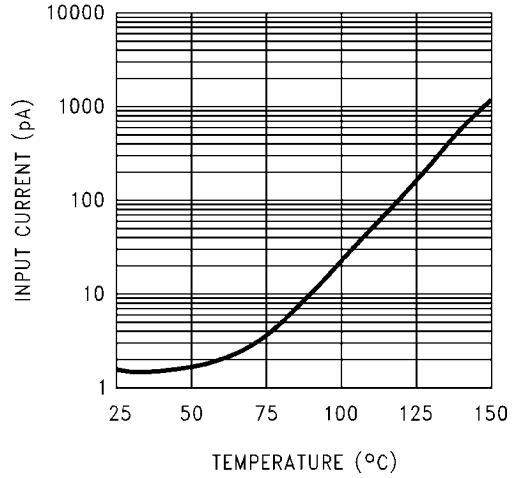

1199143

Output Voltage Swing vs. Supply Voltage

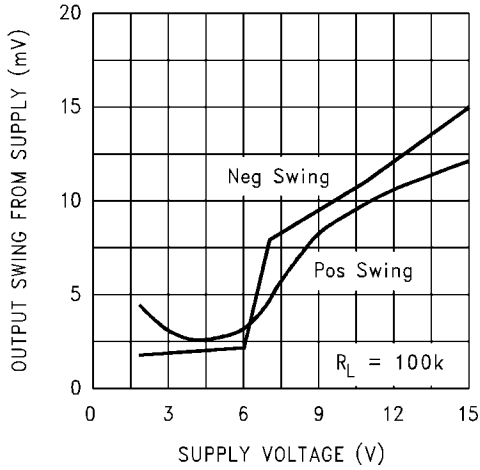

1199144

Input Voltage Noise vs. Frequency

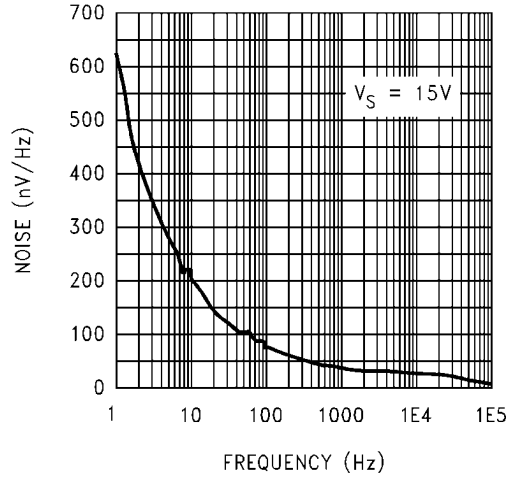

1199145

Positive PSRR vs. Frequency

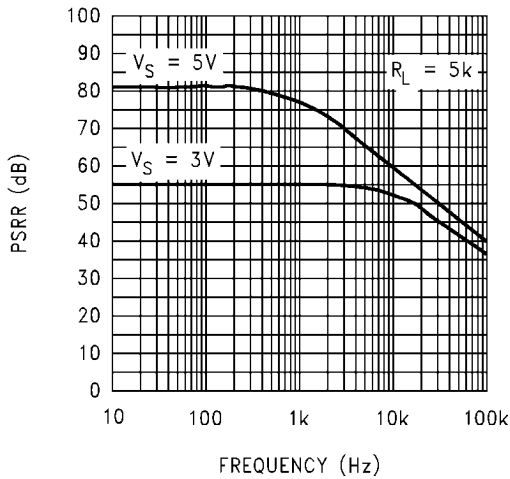

1199146

Negative PSRR vs. Frequency

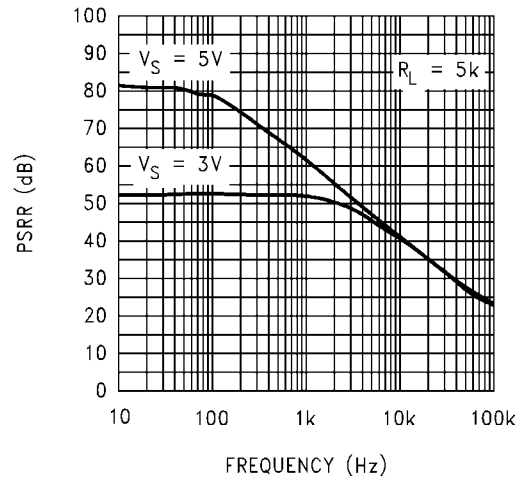

1199147

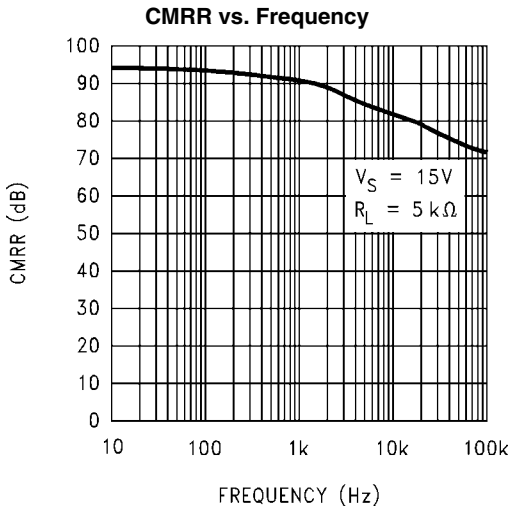

1199148

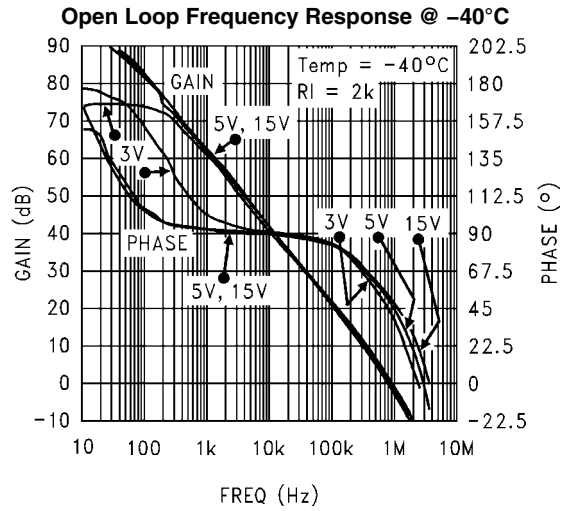

1199149

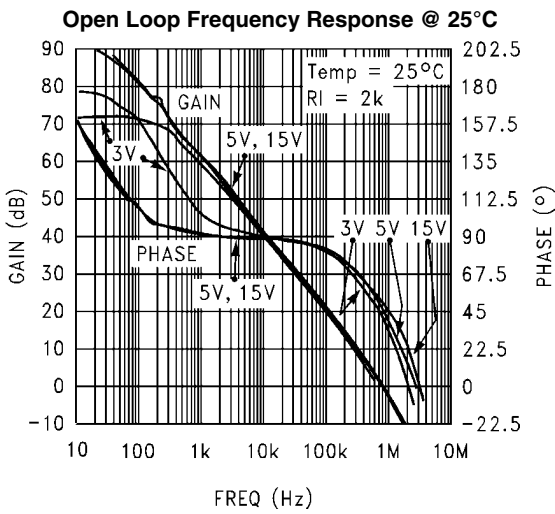

1199150

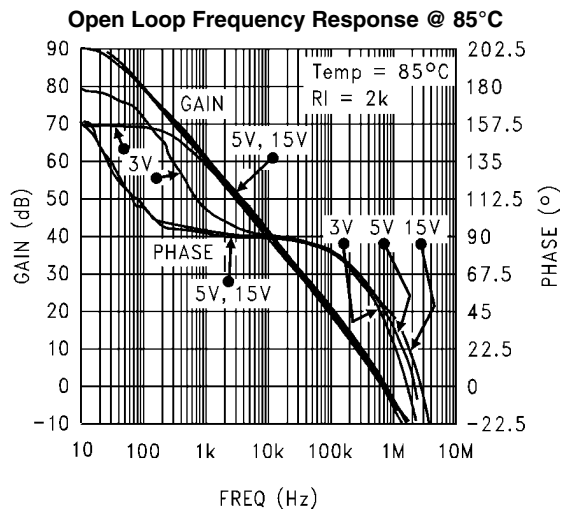

1199151

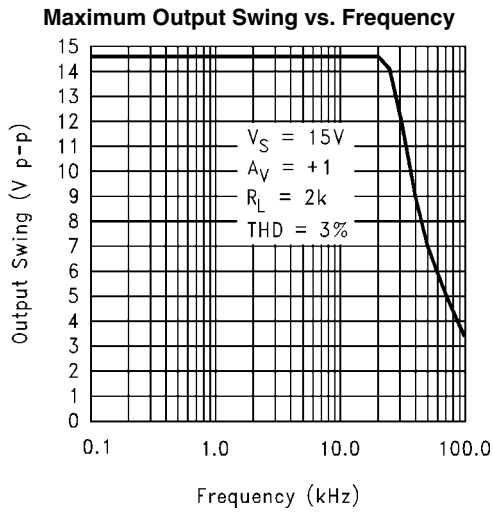

1199152

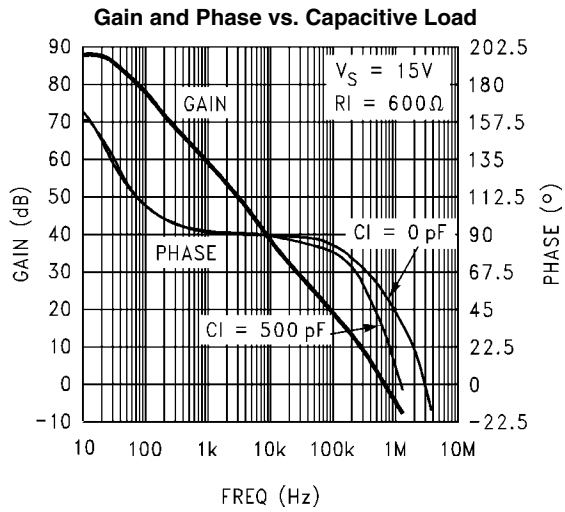

1199153

Gain and Phase vs. Capacitive Load

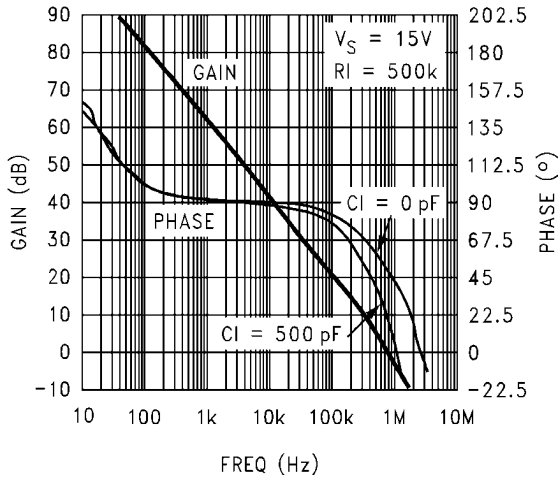

1199154

Output Impedance vs. Frequency

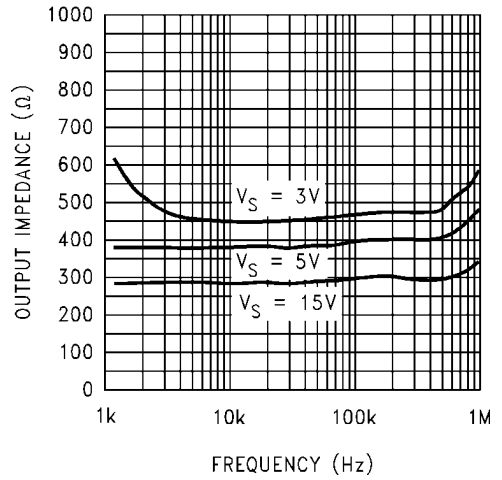

1199155

Slew Rate vs. Temperature

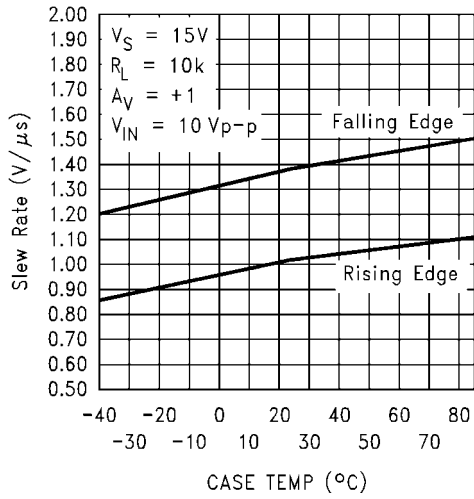

1199156

Slew Rate vs. Supply Voltage

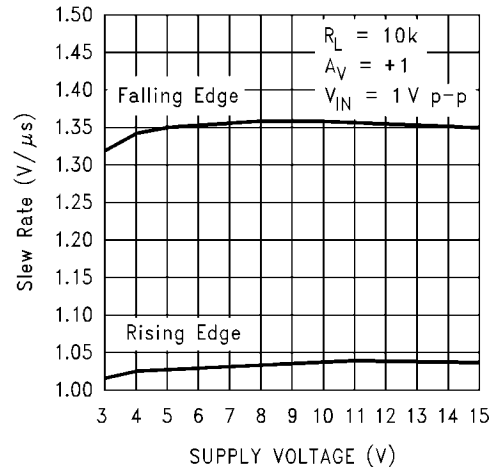

1199157

Inverting Small Signal Pulse Response

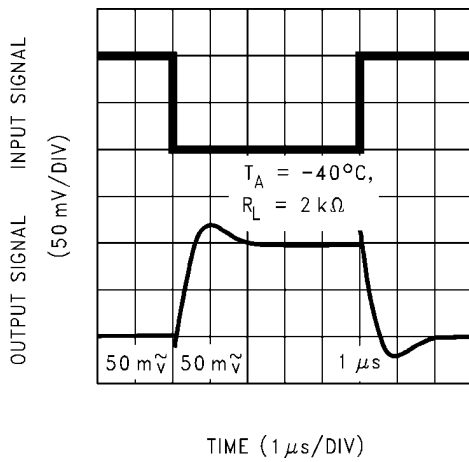

1199158

Inverting Small Signal Pulse Response

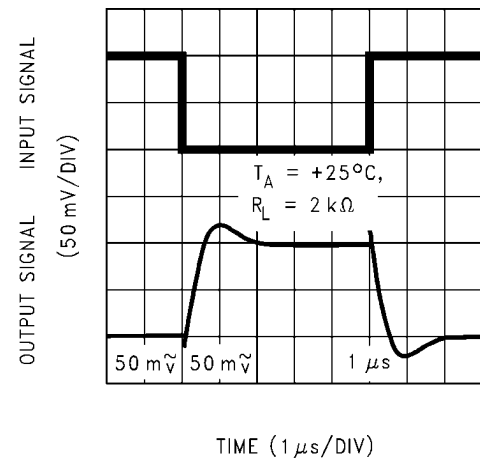

1199159

Inverting Small Signal Pulse Response

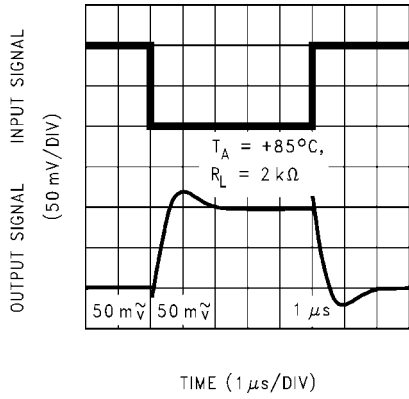

1199160

Inverting Large Signal Pulse Response

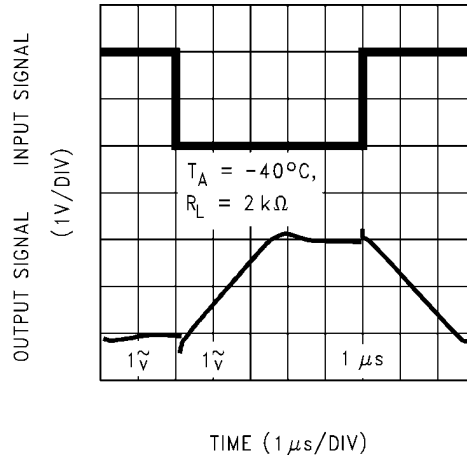

1199161

Inverting Large Signal Pulse Response

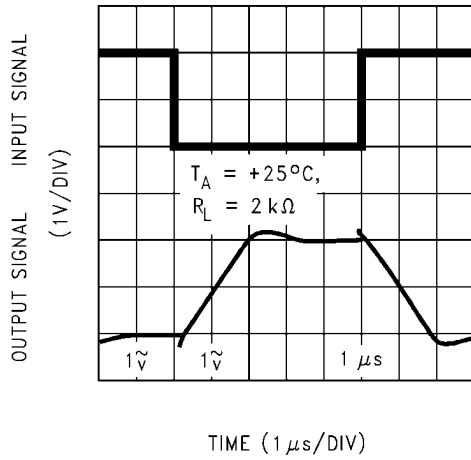

1199162

Inverting Large Signal Pulse Response

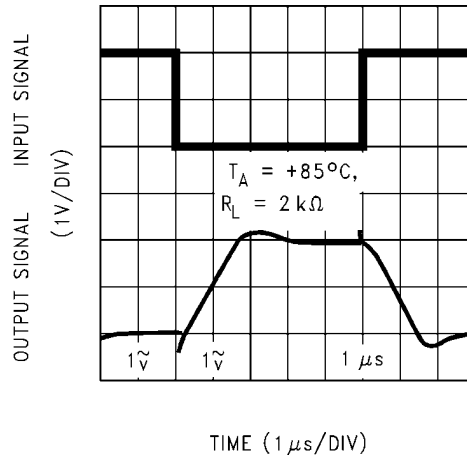

1199163

Non-Inverting Small Signal Pulse Response

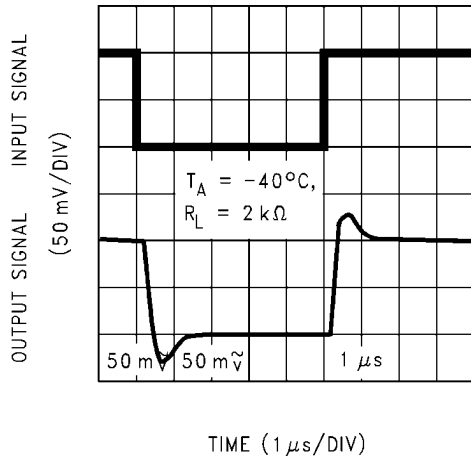

1199164

Non-Inverting Small Signal Pulse Response

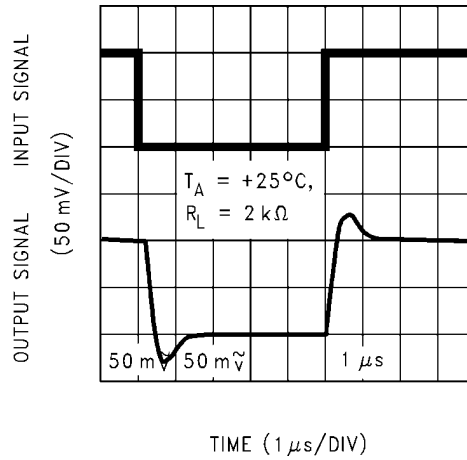

1199165

Non-Inverting Small Signal Pulse Response

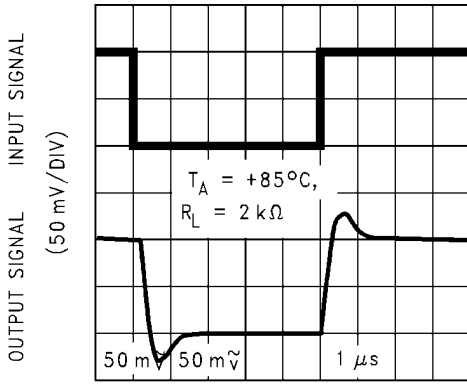

TIME (1 μs/DIV)

1199166

Non-Inverting Large Signal Pulse Response

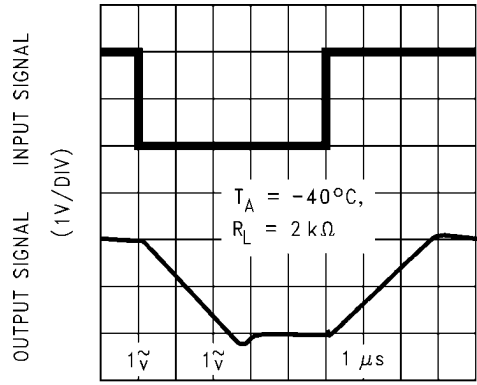

TIME (1 μs/DIV)

1199167

Non-Inverting Large Signal Pulse Response

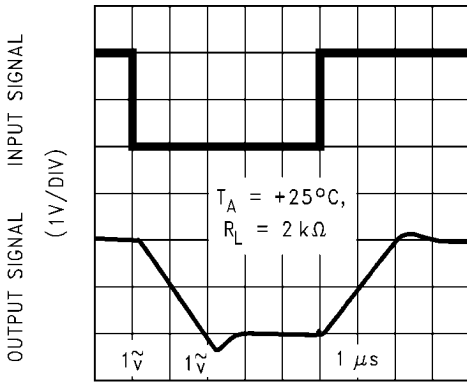

TIME (1 μs/DIV)

1199168

Non-Inverting Large Signal Pulse Response

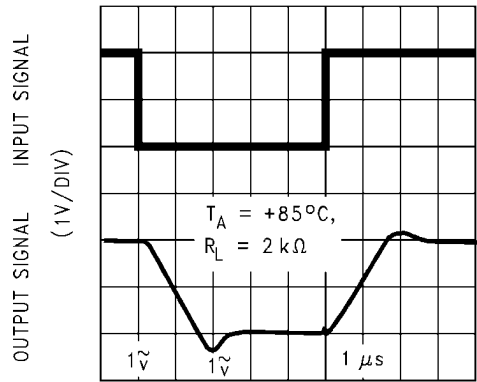

TIME (1 μs/DIV)

1199169

Stability vs. Capacitive Load

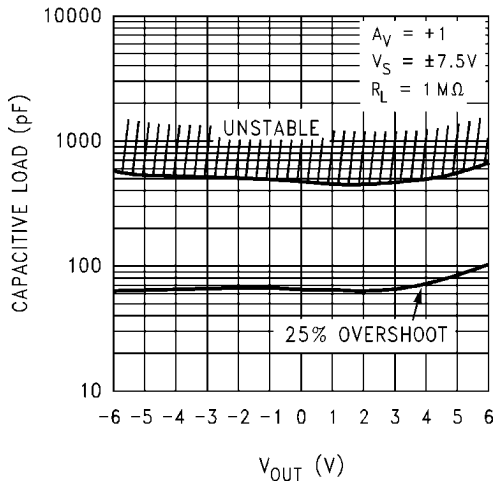

1199170

Stability vs. Capacitive Load

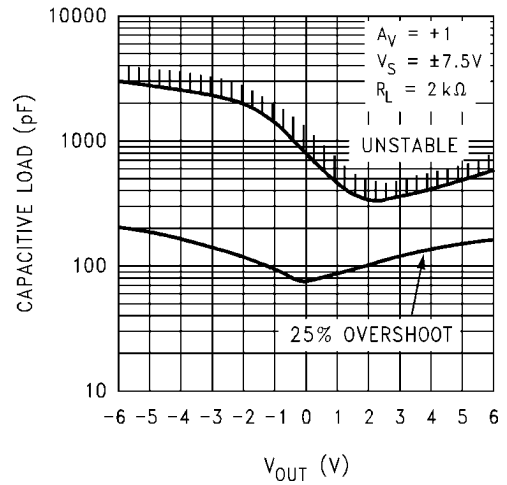

1199171

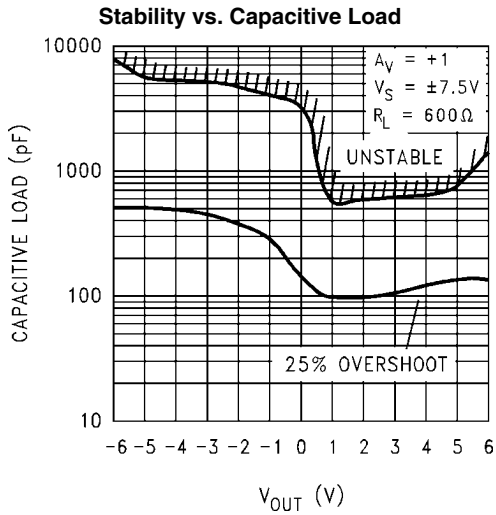

1199175

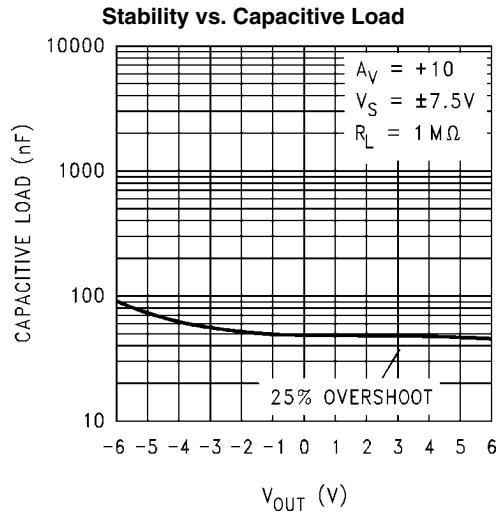

1199176

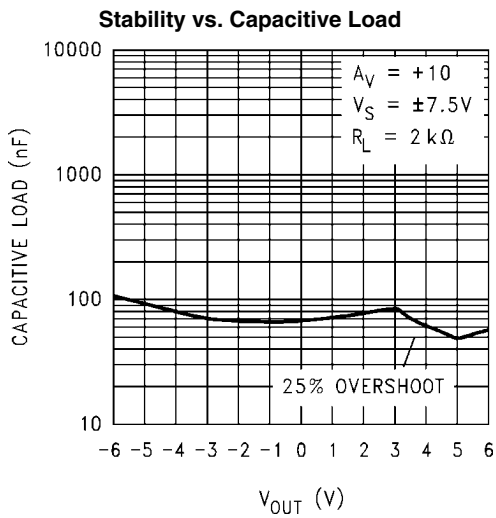

1199177

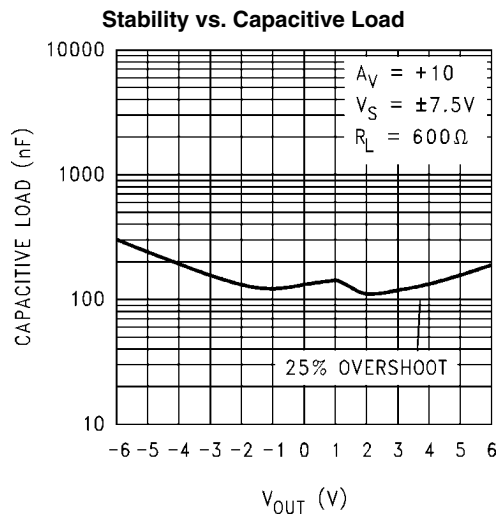

1199178

Application Information

1.0 BENEFITS OF THE LMC7101 TINY AMP

Size

The small footprint of the SOT 23-5 packaged Tiny amp, (0.120 x 0.118 inches, 3.05 x 3.00 mm) saves space on printed circuit boards, and enable the design of smaller electronic products. Because they are easier to carry, many customers prefer smaller and lighter products.

Height

The height (0.056 inches, 1.43 mm) of the Tiny amp makes it possible to use it in PCMCIA type III cards.

Signal Integrity

Signals can pick up noise between the signal source and the amplifier. By using a physically smaller amplifier package, the Tiny amp can be placed closer to the signal source, reducing noise pickup and increasing signal integrity. The Tiny amp can also be placed next to the signal destination, such as a buffer for the reference of an analog to digital converter.

Simplified Board Layout

The Tiny amp can simplify board layout in several ways. First, by placing an amp where amps are needed, instead of routing signals to a dual or quad device, long pc traces may be avoided.

By using multiple Tiny amps instead of duals or quads, complex signal routing and possibly crosstalk can be reduced.

Low THD

The high open loop gain of the LMC7101 amp allows it to achieve very low audio distortion—typically 0.01% at 10 kHz with a 10 k Ω load at 5V supplies. This makes the Tiny an excellent for audio, modems, and low frequency signal processing.

Low Supply Current

The typical 0.5 mA supply current of the LMC7101 extends battery life in portable applications, and may allow the reduction of the size of batteries in some applications.

Wide Voltage Range

The LMC7101 is characterized at 15V, 5V and 3V. Performance data is provided at these popular voltages. This wide voltage range makes the LMC7101 a good choice for devices where the voltage may vary over the life of the batteries.

2.0 INPUT COMMON MODE

Voltage Range

The LMC7101 does not exhibit phase inversion when an input voltage exceeds the negative supply voltage. *Figure 1* shows an input voltage exceeding both supplies with no resulting phase inversion of the output.

The absolute maximum input voltage is 300 mV beyond either rail at room temperature. Voltages greatly exceeding this maximum rating, as in *Figure 2*, can cause excessive current to flow in or out of the input pins, adversely affecting reliability.

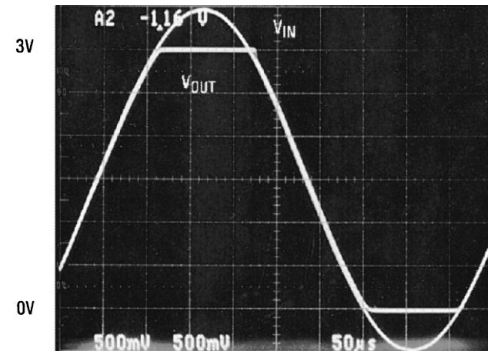

1199108

FIGURE 1. An Input Voltage Signal Exceeds the LMC7101 Power Supply Voltages with No Output Phase Inversion

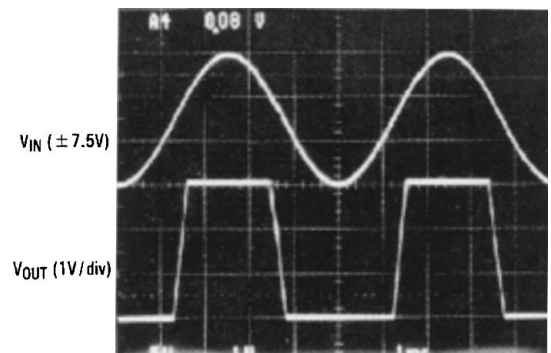

1199109

FIGURE 2. A $\pm 7.5V$ Input Signal Greatly Exceeds the 3V Supply in *Figure 3* Causing No Phase Inversion Due to R_I

Applications that exceed this rating must externally limit the maximum input current to ± 5 mA with an input resistor as shown in *Figure 3*.

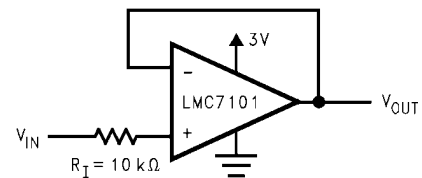

1199110

FIGURE 3. R_I Input Current Protection for Voltages Exceeding the Supply Voltage

3.0 RAIL-TO-RAIL OUTPUT

The approximate output resistance of the LMC7101 is 180 Ω sourcing and 130 Ω sinking at $V_S = 3V$ and 110 Ω sourcing and 80 Ω sinking at $V_S = 5V$. Using the calculated output resistance, maximum output voltage swing can be estimated as a function of load.

4.0 CAPACITIVE LOAD TOLERANCE

The LMC7101 can typically directly drive a 100 pF load with $V_S = 15V$ at unity gain without oscillating. The unity gain follower is the most sensitive configuration. Direct capacitive loading reduces the phase margin of op amps. The combination of the op amp's output impedance and the capacitive load induces phase lag. This results in either an underdamped pulse response or oscillation.

Capacitive load compensation can be accomplished using resistive isolation as shown in *Figure 4*. This simple technique is useful for isolating the capacitive input of multiplexers and A/D converters.

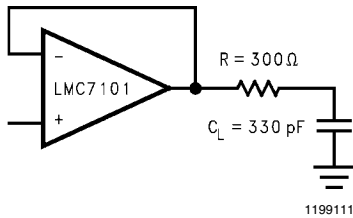

FIGURE 4. Resistive Isolation of a 330 pF Capacitive Load

5.0 COMPENSATING FOR INPUT CAPACITANCE WHEN USING LARGE VALUE FEEDBACK RESISTORS

When using very large value feedback resistors, (usually $> 500\text{ k}\Omega$) the large feedback resistance can react with the input capacitance due to transducers, photodiodes, and circuit board parasitics to reduce phase margins.

The effect of input capacitance can be compensated for by adding a feedback capacitor. The feedback capacitor (as in *Figure 5*), C_f is first estimated by:

$$\frac{1}{2\pi R_1 C_{IN}} \geq \frac{1}{2\pi R_2 C_f}$$

or

$$R_1 C_{IN} \leq R_2 C_f$$

which typically provides significant overcompensation.

Printed circuit board stray capacitance may be larger or smaller than that of a breadboard, so the actual optimum value for C_f may be different. The values of C_f should be checked on the actual circuit. (Refer to the LMC660 quad CMOS amplifier data sheet for a more detailed discussion.)

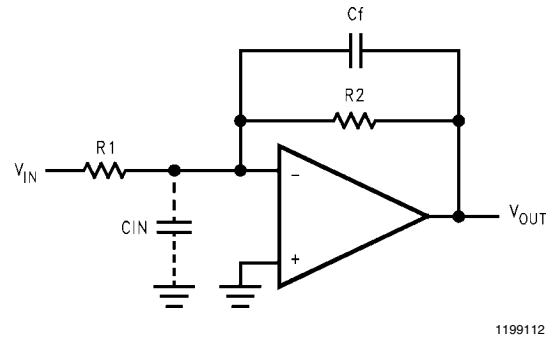

FIGURE 5. Cancelling the Effect of Input Capacitance

SOT23-5 Tape And Reel Specification

TAPE FORMAT

Tape Section	# Cavities	Cavity Status	Cover Tape Status
Leader (Start End)	0 (min)	Empty	Sealed
	75 (min)	Empty	Sealed
Carrier	3000	Filled	Sealed
	1000	Filled	Sealed
Trailer (Hub End)	125 (min)	Empty	Sealed
	0 (min)	Empty	Sealed

TAPE DIMENSIONS

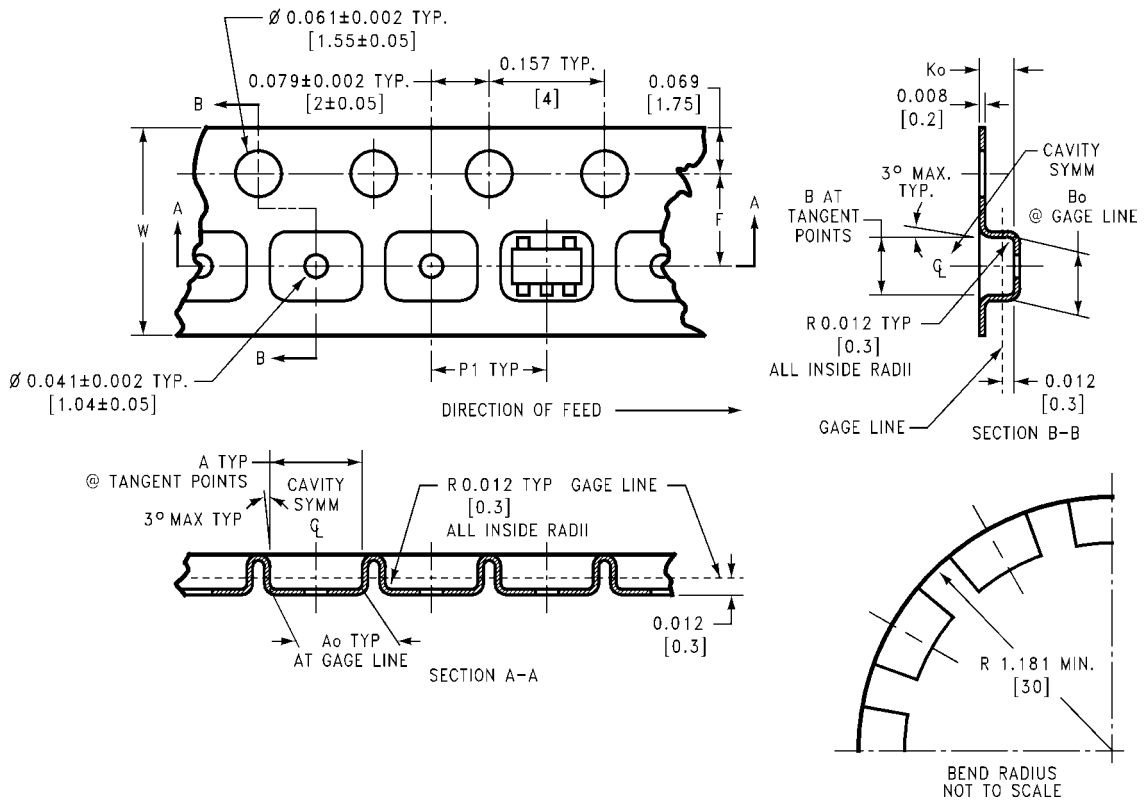

1199113

8 mm	0.130	0.124	0.130	0.126	0.138 ± 0.002	0.055 ± 0.004	0.157	0.315 ± 0.012
	(3.3)	(3.15)	(3.3)	(3.2)	(3.5 ± 0.05)	(1.4 ± 0.11)	(4)	(8 ± 0.3)
Tape Size	DIM A	DIM Ao	DIM B	DIM Bo	DIM F	DIM Ko	DIM P1	DIM W

REEL DIMENSIONS

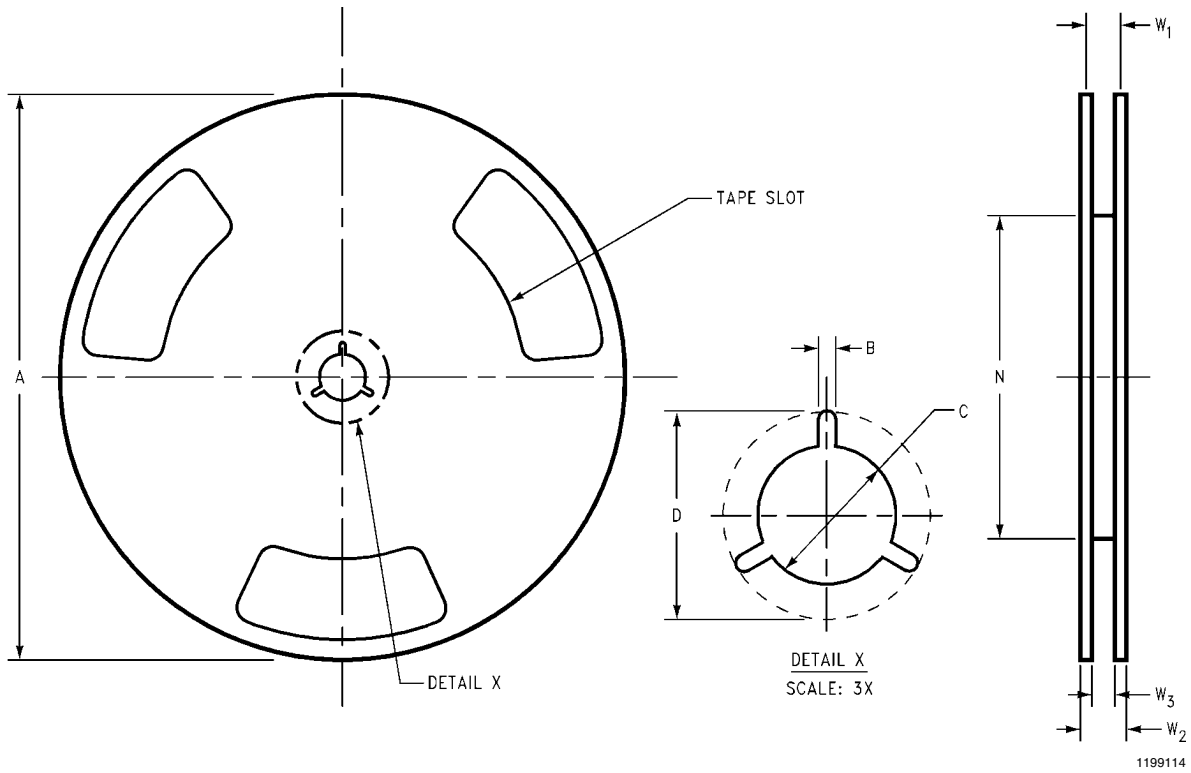

8 mm	7.00	0.059	0.512	0.795	2.165	0.331 + 0.059/-0.000	0.567	W1 + 0.078/-0.039
Tape Size	330.00	1.50	13.00	20.20	55.00	8.40 + 1.50/-0.00	14.40	W1 + 2.00/-1.00
	A	B	C	D	N	W1	W2	W3

Physical Dimensions inches (millimeters) unless otherwise noted

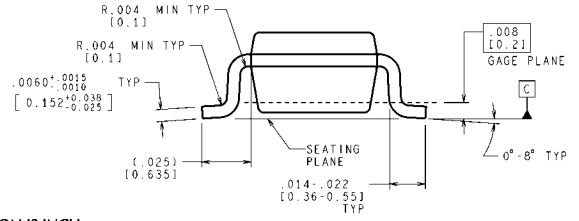
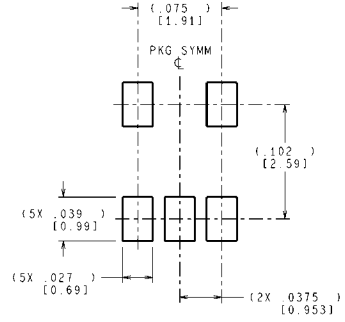
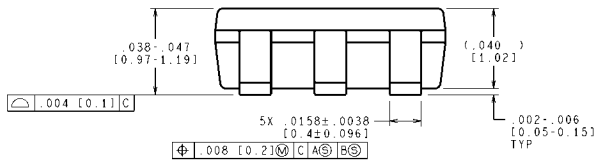
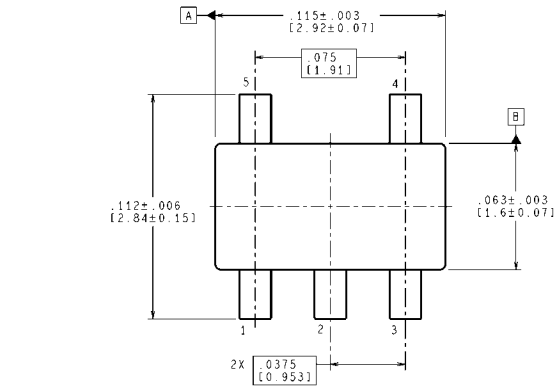

CONTROLLING DIMENSION IS INCH
 VALUES IN [] ARE MILLIMETERS
 DIMENSIONS IN () FOR REFERENCE ONLY

5-Pin SOT23 Package
NS Package Number MF05A

MF05A (Rev D)

Notes

Notes

For more National Semiconductor product information and proven design tools, visit the following Web sites at:

Products		Design Support	
Amplifiers	www.national.com/amplifiers	WEBENCH® Tools	www.national.com/webench
Audio	www.national.com/audio	App Notes	www.national.com/appnotes
Clock and Timing	www.national.com/timing	Reference Designs	www.national.com/refdesigns
Data Converters	www.national.com/adc	Samples	www.national.com/samples
Interface	www.national.com/interface	Eval Boards	www.national.com/evalboards
LVDS	www.national.com/lvds	Packaging	www.national.com/packaging
Power Management	www.national.com/power	Green Compliance	www.national.com/quality/green
Switching Regulators	www.national.com/switchers	Distributors	www.national.com/contacts
LDOs	www.national.com/ldo	Quality and Reliability	www.national.com/quality
LED Lighting	www.national.com/led	Feedback/Support	www.national.com/feedback
Voltage Reference	www.national.com/vref	Design Made Easy	www.national.com/easy
PowerWise® Solutions	www.national.com/powerwise	Solutions	www.national.com/solutions
Serial Digital Interface (SDI)	www.national.com/sdi	Mil/Aero	www.national.com/milaero
Temperature Sensors	www.national.com/tempensors	SolarMagic™	www.national.com/solarmagic
Wireless (PLL/VCO)	www.national.com/wireless	PowerWise® Design University	www.national.com/training

THE CONTENTS OF THIS DOCUMENT ARE PROVIDED IN CONNECTION WITH NATIONAL SEMICONDUCTOR CORPORATION ("NATIONAL") PRODUCTS. NATIONAL MAKES NO REPRESENTATIONS OR WARRANTIES WITH RESPECT TO THE ACCURACY OR COMPLETENESS OF THE CONTENTS OF THIS PUBLICATION AND RESERVES THE RIGHT TO MAKE CHANGES TO SPECIFICATIONS AND PRODUCT DESCRIPTIONS AT ANY TIME WITHOUT NOTICE. NO LICENSE, WHETHER EXPRESS, IMPLIED, ARISING BY ESTOPPEL OR OTHERWISE, TO ANY INTELLECTUAL PROPERTY RIGHTS IS GRANTED BY THIS DOCUMENT.

TESTING AND OTHER QUALITY CONTROLS ARE USED TO THE EXTENT NATIONAL DEEMS NECESSARY TO SUPPORT NATIONAL'S PRODUCT WARRANTY. EXCEPT WHERE MANDATED BY GOVERNMENT REQUIREMENTS, TESTING OF ALL PARAMETERS OF EACH PRODUCT IS NOT NECESSARILY PERFORMED. NATIONAL ASSUMES NO LIABILITY FOR APPLICATIONS ASSISTANCE OR BUYER PRODUCT DESIGN. BUYERS ARE RESPONSIBLE FOR THEIR PRODUCTS AND APPLICATIONS USING NATIONAL COMPONENTS. PRIOR TO USING OR DISTRIBUTING ANY PRODUCTS THAT INCLUDE NATIONAL COMPONENTS, BUYERS SHOULD PROVIDE ADEQUATE DESIGN, TESTING AND OPERATING SAFEGUARDS.

EXCEPT AS PROVIDED IN NATIONAL'S TERMS AND CONDITIONS OF SALE FOR SUCH PRODUCTS, NATIONAL ASSUMES NO LIABILITY WHATSOEVER, AND NATIONAL DISCLAIMS ANY EXPRESS OR IMPLIED WARRANTY RELATING TO THE SALE AND/OR USE OF NATIONAL PRODUCTS INCLUDING LIABILITY OR WARRANTIES RELATING TO FITNESS FOR A PARTICULAR PURPOSE, MERCHANTABILITY, OR INFRINGEMENT OF ANY PATENT, COPYRIGHT OR OTHER INTELLECTUAL PROPERTY RIGHT.

LIFE SUPPORT POLICY

NATIONAL'S PRODUCTS ARE NOT AUTHORIZED FOR USE AS CRITICAL COMPONENTS IN LIFE SUPPORT DEVICES OR SYSTEMS WITHOUT THE EXPRESS PRIOR WRITTEN APPROVAL OF THE CHIEF EXECUTIVE OFFICER AND GENERAL COUNSEL OF NATIONAL SEMICONDUCTOR CORPORATION. As used herein:

Life support devices or systems are devices which (a) are intended for surgical implant into the body, or (b) support or sustain life and whose failure to perform when properly used in accordance with instructions for use provided in the labeling can be reasonably expected to result in a significant injury to the user. A critical component is any component in a life support device or system whose failure to perform can be reasonably expected to cause the failure of the life support device or system or to affect its safety or effectiveness.

National Semiconductor and the National Semiconductor logo are registered trademarks of National Semiconductor Corporation. All other brand or product names may be trademarks or registered trademarks of their respective holders.

Copyright© 2009 National Semiconductor Corporation

For the most current product information visit us at www.national.com



National Semiconductor Americas Technical Support Center
 Email: support@nsc.com
 Tel: 1-800-272-9959

National Semiconductor Europe Technical Support Center
 Email: europe.support@nsc.com

National Semiconductor Asia Pacific Technical Support Center
 Email: ap.support@nsc.com

National Semiconductor Japan Technical Support Center
 Email: jpn.feedback@nsc.com