

RKT-3006 SQUARE TRIMMING POTENTIOMETER

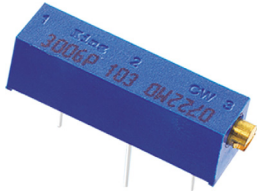

- Multiturn/ Cermet/ Industrial/ Sealed
- 3 Terminal Styles

Electrical Characteristics	
Standard Resistance Range	10Ω - 5MΩ
Resistance Tolerance	±10%
Absolute Minimum Resistance	≤1% R or 5n
Contact Resistance Variation	CRV≤4% or 5n
Insulation Resistance	R1≥1GΩ(100Vac)
Withstand Voltage	640Vac
Effective Travel	22±2 turns nom

Environmental Characteristics	
Power Rating (315volts max)	0.75W@70°C, 0W@125°C
Temperature Range	-55°C ~ +125°C
Temperature Coefficient	200 or ±100ppm/°C
Temperature Variation	-55°C, 30min, +125°C 30min, 5 cycles ΔR≤5%R, Δ(Uab/Uac)≤5%
Vibration	10 - 500Hz, 0.75mm, 6h ΔR≤5%R, Δ(Uab/Uac)≤7.5%
Collision	390m/s ² , 4000cycles, ΔR≤2%R
Electrical Endurance at 70°C	0.75W@70°C 1000h, ΔR≤5%R CRV≤3% or 5Ω
Rotational Life	200 cycles ΔTR≤10%R, CRV≤3% or 5n

Physical Characteristics	
Starting Torque	≤35mN·m
Marking	Resistance Tolerance (When no identification, it is of ± 10%) Resistance Code, Model
Standard Packaging	25pcs, per tube

Common Dimensions

RKT-3006

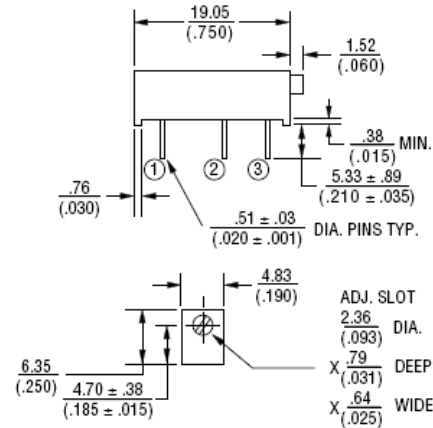

RKT-3006W

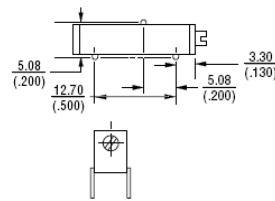

RKT-3006Y

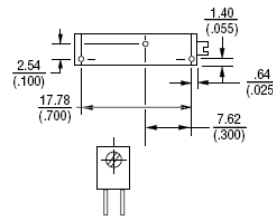

RKT-3006P

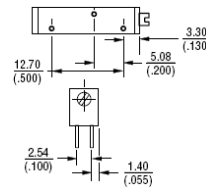

How to Order

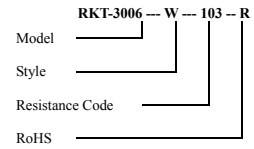

WIPER 2(d)

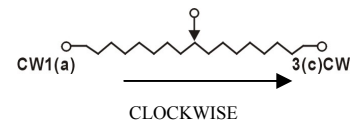

Tolerance is ±0.25 if no identification

Resistance Table

Resistance(Ohms)	Resistance Code
10	100
20	200
50	500
100	101
150	151
200	201
250	251
300	301
470	471
500	501
680	681
1,000	102
1,500	152
2,000	202
2,200	222
2,500	252
3,000	302
4,700	472
5,000	502
6,800	682
10,000	103
15,000	153
20,000	203
22,000	223
25,000	253
30,000	303
33,000	333
47,000	473
50,000	503
68,000	683
100,000	104
150,000	154
200,000	204
220,000	224
250,000	254
300,000	304
330,000	334
470,000	474
500,000	504
680,000	684
1,000,000	105
2,000,000	205
2,200,000	225
5,000,000	505

Special resistances available.

Note: Specification are subject to change without notice.

Kingtronics® International Company

Tel: (852) 8106 7033 Fax: (852) 8106 7099

Website: www.kingtronics.com Email: info@kingtronics.com