

AVX Advanced Ceramic Capacitors for Power Supply, High Voltage and Tip and Ring Applications

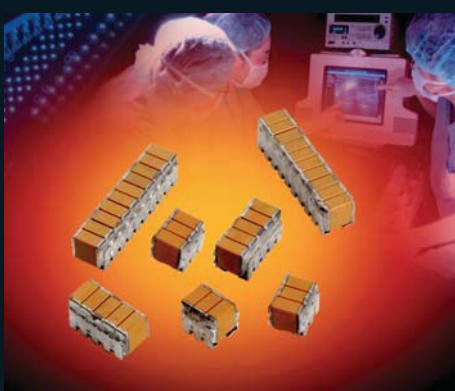
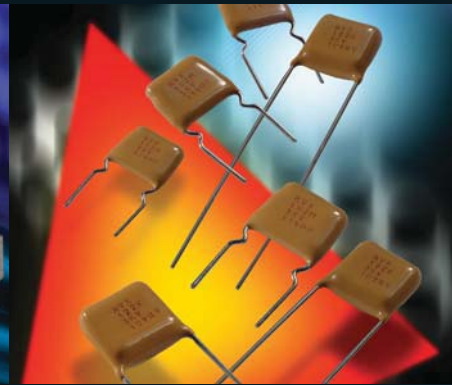
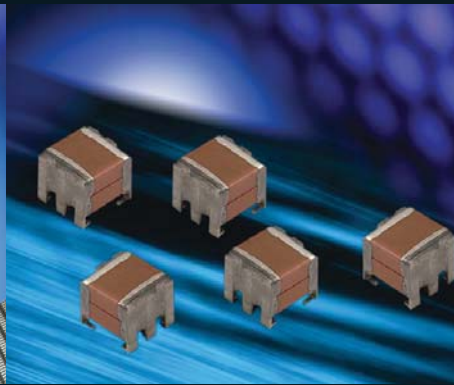
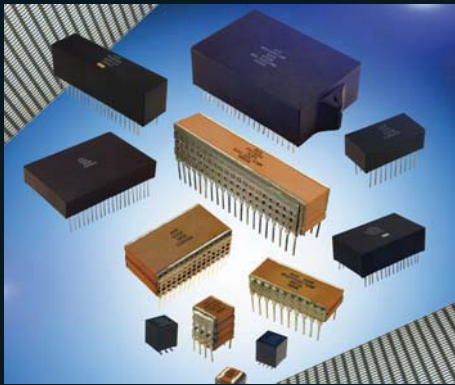

Version 10.11

www.avx.com

AVX
A KYOCERA GROUP COMPANY

Contents

Introduction – Application Specific MLCs	2-3
SMPS (Switch Mode Power Supply) Capacitors	4-7
SM Style Stacked MLC Capacitors	8-28
RM Style Stacked MLC Capacitors	29-31
SMX High Temperature	32-35
CH/CV Style Vertical/Horizontal Mount	36-41
SXP Style for High Temperature Application up to 200°	42-43
TurboCap™	44-46
RoHS Compliant TurboCap™	47-49
MH Style	50
RH Style	51-52
Custom Lead Configurations	53
Assembly Guidelines (SM, CH, CV & RH Styles)	54-55
SK Style	56-57
SE Style	58-59
CECC Offering	60
High Voltage MLC Ledged	61
ESCC Qualified SMPS	61-66
HV Style (US Preferred Sizes) DIP Lead	67-69
CH/CV Style (European Preferred Sizes) Vertical/Horizontal Mount, DIP & Radial Lead	70-73
SV Style Radial Lead	74-76
MLC Chip Capacitors	77
Basic Construction	77
General Description	78-81
Surface Mounting Guide	82-86
MIL-PRF-123/Chips	87-91
High Voltage MLC Chips	92-93
High Voltage MLCC Tin/Lead Termination “B”	94-95
High Voltage MLC Chips FLEXITERM®	96-97
High Voltage MLC Ledged Chips	98-99
Hi-Q® High RF Power	100-104
Tip & Ring Chips	105-106
Tip & Ring Tin/Lead Termination “B”	107-108
MLC Chips, Packaging	109-110
Single-In-Line Packages (SIP)	111-112
Discoidal MLC Feed-Through Capacitors and Filters	113
DC Style (US Preferred Sizes)	114-116
XB Style (European Preferred Sizes)	117-120
XF Style (Feed-Through Discoidal)	117-120
Filtered Arrays XD Type	121
Baseline Management – BS9100 Requirements	122
Advanced Application Specific Products	123

Application Specific MLCs



Problem Solving at the Leading Edge

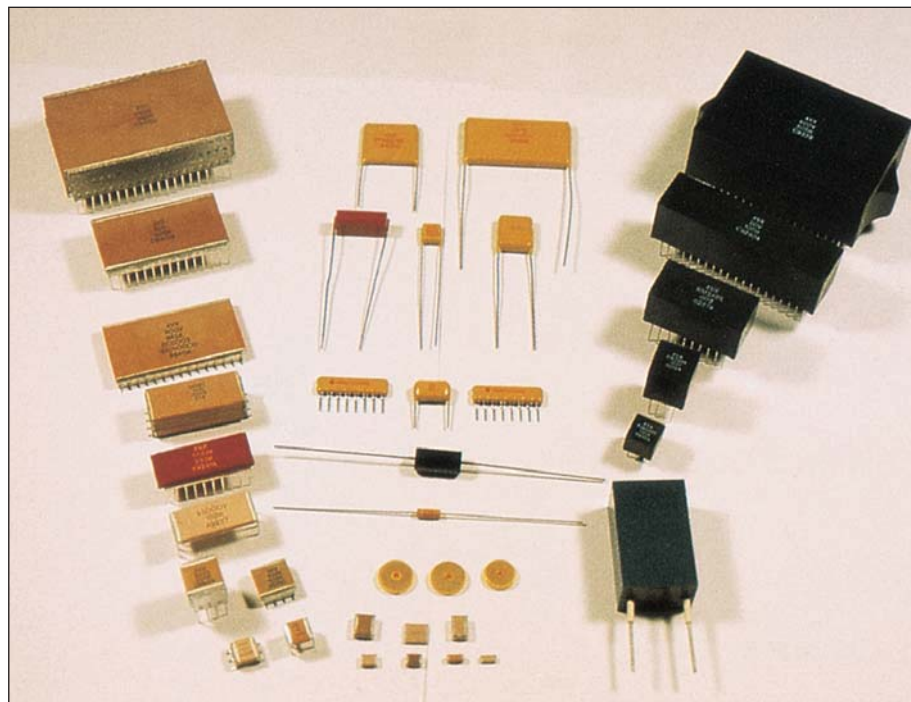

As the world's leading manufacturer and innovator in application specific multilayer ceramic (ASMLC) capacitors, AVX offers a unique technological and production capability to the field. AVX actively pursues and satisfies the high reliability and custom needs of a variety of governmental and industrial customers. Successful involvement in missile programs, extensive work in ultra-high reliability telecommunications and sophisticated capacitor design applications – all have established AVX as the source for

advanced and high reliability ASMLC capacitors. **Advanced Products are ISO9001 certified organizations for design and manufacturing of MLC capacitors.**

AVX Advanced Application Capacitors are organized around three distinct functions:

- Application Specific Development Laboratories
- Advanced Manufacturing Facilities
- Quality Control

For designs or applications not listed please consult Advanced Products

Olean, NY, USA - 716-372-6611

Coleraine, Northern Ireland - ++44(0) 28703 44188

St. Appollinaire, France - ++33(0) 38071 7400



International Space Station



Defense / Military



Telecommunications
Undersea Cable Repeater



Application Specific MLCs



Problem Solving at the Leading Edge

APPLICATION SPECIFIC DEVELOPMENT LABORATORIES

Initially, AVX technical personnel communicate with customers to learn the requirements that the new capacitor must satisfy. The personnel involved are well-versed in material, manufacturing and electronic application technologies. They study the overall application and the environment in which the part will function. Programs are begun for selection of appropriate ceramic formulations, metal systems and designs. These programs yield a detailed technology profile from which mechanical design and process specifications follow.

ADVANCED MANUFACTURING FACILITIES

The ability and reputation of AVX in high reliability MLCs is due in part to the company's complete control over all phases of the production process. This includes powder processing, tape casting and/or wet build-up, green MLC assembly and final capacitor assembly/packaging. Recent renovations at AVX have upgraded green MLC assembly areas to certified clean room levels.

A favorite feature with many customers of AVX is our ability to work with customers in solving special packaging

requirements. This includes special lead configurations and multiple chip packaging that simplifies the mounting of specialty capacitors. To the customer, the total capability of AVX assures a high level of consistent control at all steps of production.

QUALITY CONTROL

The Q. A. organization is an integral part of manufacturing. Quality Control tests the product of each manufacturing process, detects flaws or variations from the narrow acceptable standard and isolates the cause of the deviation. Corrective action can then be taken to return the process to within its predetermined control levels.

Quality Assurance has large and well-equipped laboratories where statistical samples are evaluated and tested to determine failure rates, characterize products and assure compliance with specification. Both destructive and non-destructive testing are used, including advanced ultrasonic inspection equipment for non-destructive inspection of an entire production quantity.

Put the experience, technology and facilities of the leading company in multilayer ceramics to work for you. No other source offers the unique combination of capability and commitment to advanced application specific components.

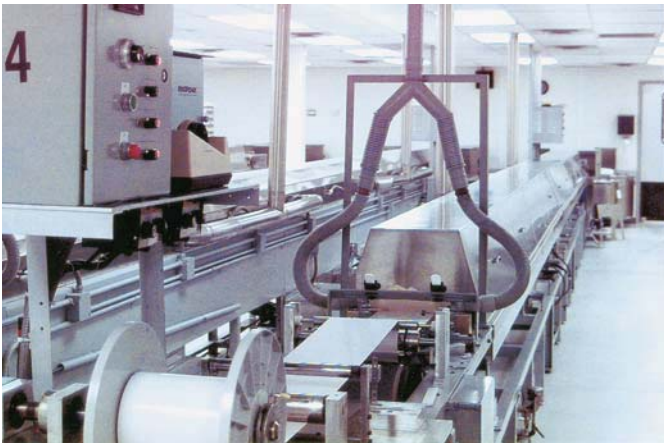

FOREWORD

High speed switch mode power supplies place high demands on the capacitors used in the input or output filters of Resonant DC-DC or Pulse Modulated DC-DC converters. AVX Corporation has developed several multilayer ceramic (MLC) capacitor styles for these switcher applications. These capacitors have been extensively tested and characterized and found to have almost ideal performances to meet the stringent requirements of these applications.

Input Filter Capacitor

The Input Filter capacitor is required to perform two functions: To supply an unrestricted burst of current to the power supply switch circuitry and to not only do it without generating any noise, but to help suppress noise generated in the switch circuitry. It is, in effect, a very large decoupling capacitor. It must have very low ESL, capabilities for very high dv/dt , as well as di/dt and it must have a very low ESR to eliminate power loss.

The distance from the primary DC source, as well as the type of capacitor used in this source (usually electrolytics), presents a very high inductance to the input of the Switcher. The MLC input capacitor, with its excellent ESL and ESR characteristics, is located physically close to the switch circuitry. Repetitive peak currents, inherent with the Switcher design, require a high ripple capability, as well as high surge capability for transients, both induced and conducted from other sources. MLCs have both these capabilities.

Output Filter Capacitor

The output from the switching circuit of a Switcher consists of current on and off. From an elevated DC reference, this current is an AC ripple additive on the DC. In order to smooth this ripple effect, a filter circuit (usually inductive input) is built to allow a storage of energy to take place during the rising ripple portion and to allow a discharge of energy during the falling ripple portion.

The ESR and ESL of the capacitor contribute to the net ripple effect. The output filter capacitor is chosen for ESR, and with previous types of capacitors, multiples were used in an attempt to lower the net ESR. The MLC offers ESRs well below the minimum allowable to lower noise levels, thus eliminating the need for multiple units.

Other MLC Capacitors for SMPS Applications

AVX also manufactures coupling, decoupling, resonant and snubber capacitors for SMPS applications. Contact AVX for Application Specific S.M.P.S. capacitor requirements.

Olean, NY, USA	716-372-6611
Coleraine, Northern Ireland	++44(0) 28703 44188
St. Apollinaire, France	++33(0) 38071 7400

ASMLC CAPACITOR SELECTION

SMPS Design Information (SM, CH, CV, RH and SK Styles)

Absolute Maximum Output Capacitance
Assuming no ESL and no ESR

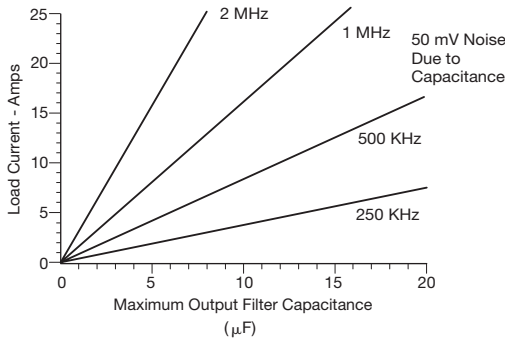

Absolute Maximum Capacitance ESL
Assuming no ESR - Capacitive Induced Ripple

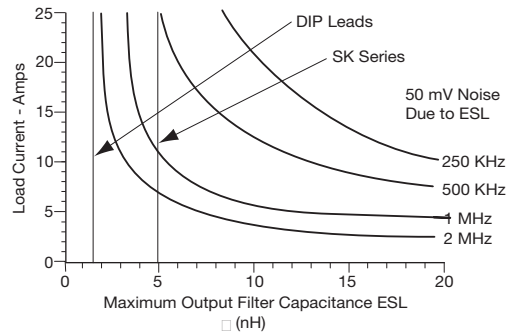

Absolute Maximum Capacitance ESR
Assuming no ESL - Capacitive Induced Ripple

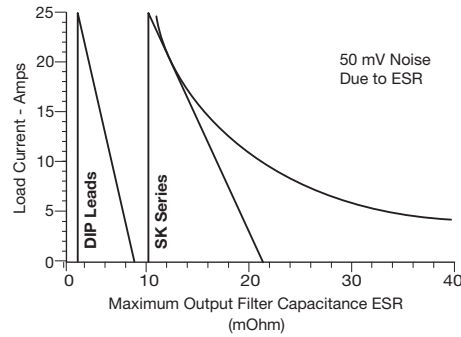

ASMLC CAPACITOR PERFORMANCE

Capacitance as Measured from dv/dt Slope
200 mA/ns Current Pulse
Measurement starts after inductive ring decay

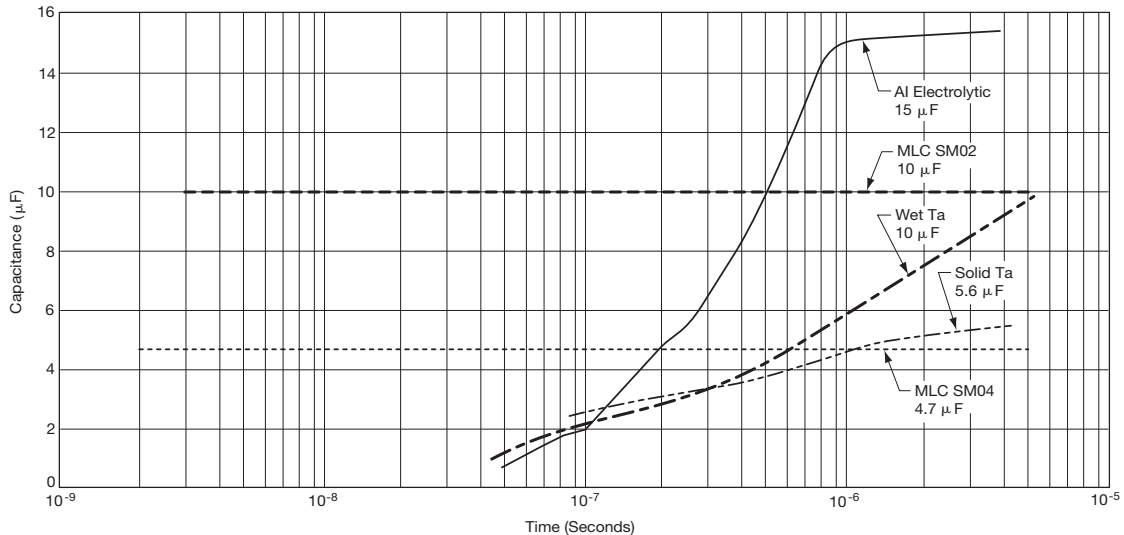

SMPS Capacitors



Capacitor Performance

AC Ripple Capability

Due to the wide range of product offering in this catalog, the AC ripple capabilities for switch mode power supply capacitors and high voltage capacitors are provided in the form of IBM compatible software package called SpiCalci. It is available free from AVX and can be downloaded for free from AVX website: www.avx.com.



SpiCalci program will provide answers to most of the design engineers' questions on critical parameters for their specific applications:

- Equivalent Series Resistance
- function of frequency and temperature
- Equivalent Series Inductance
- function of design
- Self Resonant Frequency
 $f = 1 / (2 \times \pi \sqrt{L \times C})$
- Thermal Characteristics
- function of design
- AC Ripple Capabilities
- function of frequency, temperature and design

Examples of Product Performance

**TYPICAL ESR -vs- Frequency
FOR SM04 STYLE CAPACITORS**

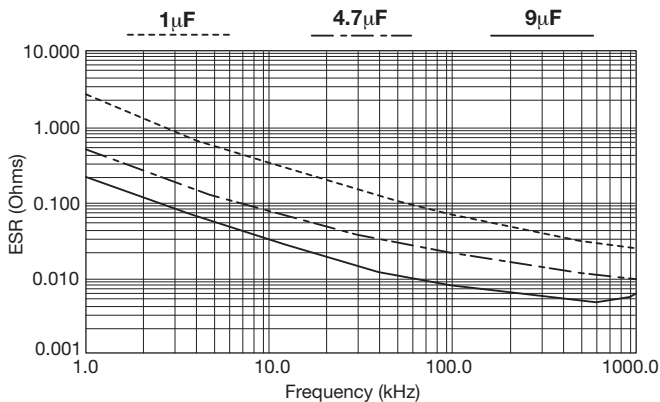

**MAXIMUM RMS CURRENT FOR 50 VDC, CH - X7R
@ 100 KHz & 25°C Ambient
ASSUMING MAX. CAP. FOR SINGLE CHIP CONSTRUCTION**

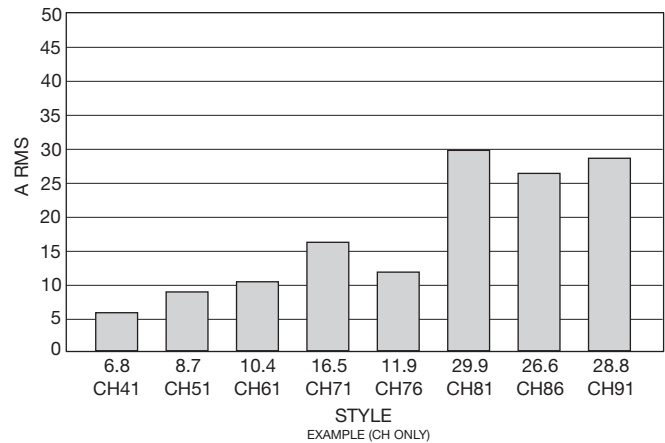

**MAXIMUM RMS CURRENT FOR 50 WVDC, SM - X7R
@ 100 KHz & 25°C Ambient
ASSUMING MAX. CAP. FOR SINGLE CHIP CONSTRUCTION**

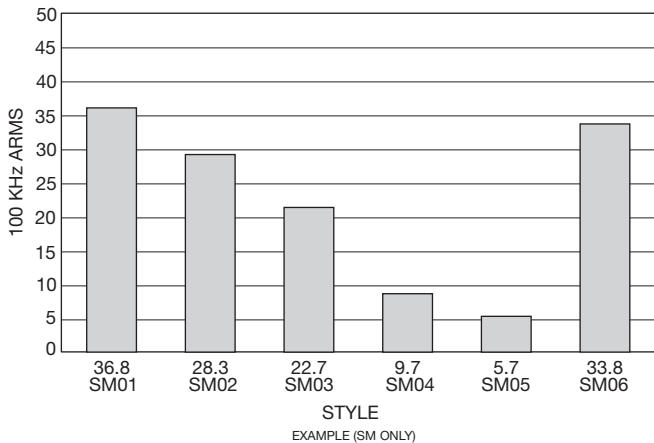

**MAXIMUM RMS CURRENT FOR 25 WVDC, SK - Z5U
@ 100 KHz & 25°C Ambient
ASSUMING MAX. CAP. FOR EACH STYLE**

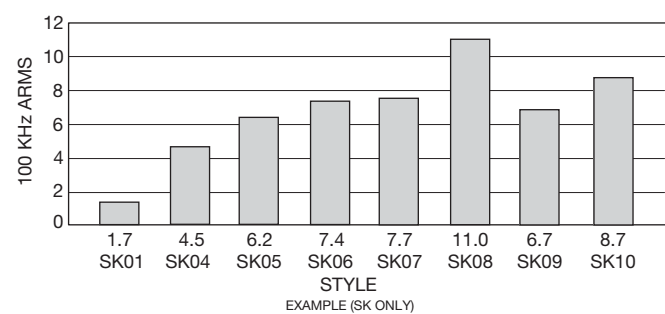

SMPS Capacitors

Application Information on SupraCap®

SUPRACAP® - LARGE CAPACITANCE VALUE MLCs

High speed switch mode power supplies require extremely low equivalent series resistance (ESR) and equivalent series inductance (ESL) capacitors for input and output filtering. These requirements are beyond the practical limits of electrolytic capacitors, both aluminum and tantalums, but are readily met by multilayer ceramic (MLCs) capacitors (Figure 1).

Theoretical SMPS's output filter capacitor values are in the range of 6-10 $\mu\text{F}/\text{amp}$ at 40KHz and drop to less than 1 $\mu\text{F}/\text{amp}$ at 1MHz. Most electrolytic applications use 10 to 100 times the theoretical value in order to obtain lower ESR from paralleling many capacitors. This is not necessary with SupraCap® MLC capacitors which inherently have ESRs in the range of milliohms. These extremely low values of ESR mean low ripple voltage and less self-heating of the capacitor.

Output noise spikes are reduced by lowering the filter capacitance self-inductance. The ripple current is a triangle wave form with constant di/dt except when it changes polarity, then the di/dt is very high. The noise voltage generated by the filter capacitor is

$$V_{\text{Noise}} = L_{\text{Capacitor}} di/dt$$

AVX SupraCap® devices have inductance value less than 3nH. Figure 2 compares a 5.6 μF MLC to a 5.6 μF tantalum which was specially designed for low ESR and ESL. When subjected to a di/dt of 200 mA/ns the tantalum shows an ESR of 165 m Ω and an ESL of 18nH versus the MLC's 4 m Ω and 0.3 nH. These performance differences allow considerable reduction in size and weight of the filter capacitor.

Additionally, MLCs are compatible with surface mount technology reflow and assembly techniques which is the desirable assembly for conversion frequencies exceeding 1 MHz. Electrolytic capacitors (both aluminum and tantalum) are not compatible with normal vapor phase (VPS) or infrared (IR) reflow temperatures (205-215°C) due to electrolyte and structural problems. AVX SupraCap® devices are supplied with lead frames for either thru-hole or surface mount assembly. The lead frames act as stress relief for differences in coefficients of expansion between the large ceramic chip ($\approx 10 \text{ ppm}/^\circ\text{C}$) and the PC boards.

ESR Comparison of Different Capacitor Technologies

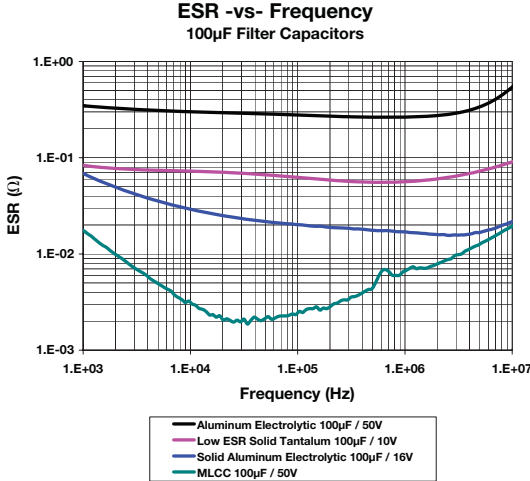

Figure 1

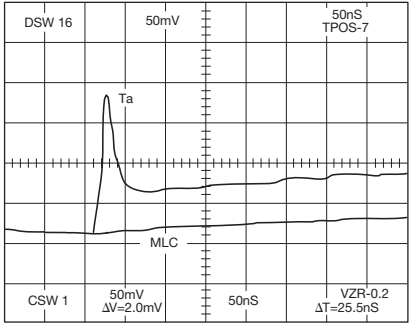
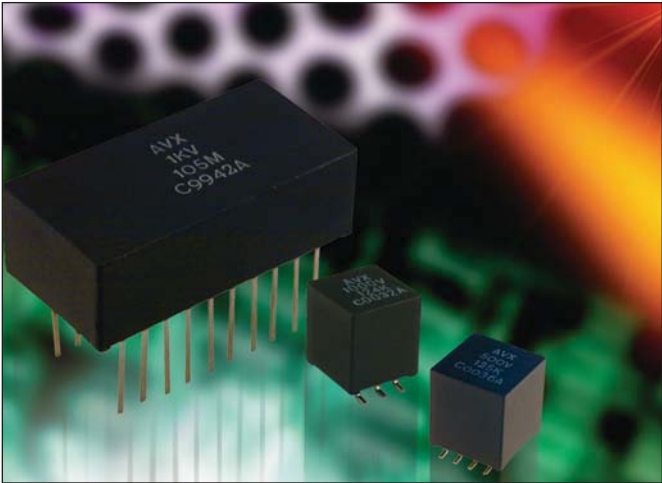
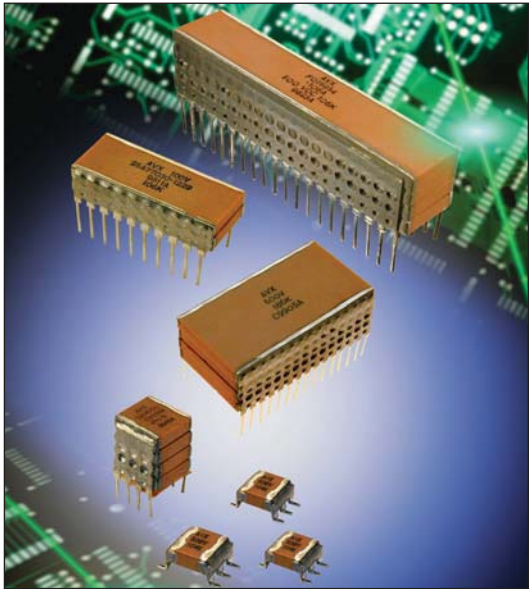

Figure 2



SMPS Stacked MLC Capacitors



(SM Style) Technical Information on SMPS Capacitors

ELECTRICAL SPECIFICATIONS

Temperature Coefficient

C0G: A Temperature Coefficient - 0 ±30 ppm/°C, -55° to +125°C
 X7R: C Temperature Coefficient - ±15%, -55° to +125°C
 Z5U: E Temperature Coefficient - +22, -56%, +10° to +85°C

Capacitance Test (MIL-STD-202 Method 305)

C0G: 25°C, 1.0±0.2 Vrms (open circuit voltage) at 1KHz
 X7R: 25°C, 1.0±0.2 Vrms (open circuit voltage) at 1KHz
 Z5U: 25°C, 0.5 Vrms max (open circuit voltage) at 1KHz

Dissipation Factor 25°C

C0G: 0.15% Max @ 25°C, 1.0±0.2 Vrms (open circuit voltage) at 1KHz
 X7R: 2.5% Max @ 25°C, 1.0±0.2 Vrms (open circuit voltage) at 1KHz
 Z5U: 3.0% Max @ 25°C, 0.5 Vrms max (open circuit voltage) at 1KHz

Insulation Resistance 25°C (MIL-STD-202 Method 302)

C0G and X7R: 100K MΩ or 1000 MΩ-μF, whichever is less.
 Z5U: 10K MΩ or 1000 MΩ-μF, whichever is less.

Insulation Resistance 125°C (MIL-STD-202 Method 302)

C0G and X7R: 10K MΩ or 100 MΩ-μF, whichever is less.
 Z5U: 1K MΩ or 100 MΩ-μF, whichever is less.

Dielectric Withstanding Voltage 25°C (Flash Test)

C0G and X7R: 250% rated voltage for 5 seconds with 50 mA max charging current. (500 Volt units @ 750 VDC)
 Z5U: 200% rated voltage for 5 seconds with 50 mA max charging current.

Life Test (1000 hrs)

C0G and X7R: 200% rated voltage at +125°C. (500 Volt units @ 600 VDC)
 Z5U: 150% rated voltage at +85°C

Moisture Resistance (MIL-STD-202 Method 106)

C0G, X7R, Z5U: Ten cycles with no voltage applied.

Thermal Shock (MIL-STD-202 Method 107, Condition A)

Immersion Cycling (MIL-STD-202 Method 104, Condition B)

Resistance To Solder Heat (MIL-STD-202, Method 210, Condition B, for 20 seconds)

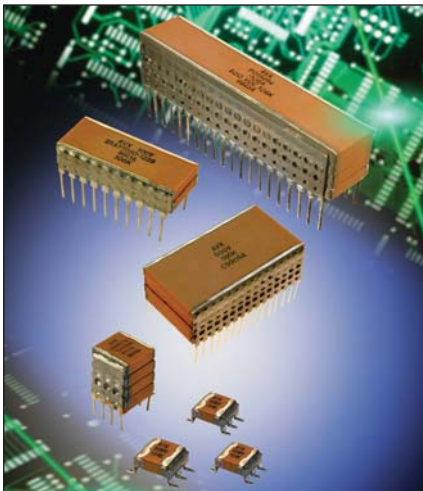

Typical ESR Performance (mΩ)

	Aluminum Electrolytic 100μF/50V	Low ESR Solid Tantalum 100μF/10V	Solid Aluminum Electrolytic 100μF/16V	MLCC SMPS 100μF/50V	MLCC SMPS 4.7μF/50V
ESR @ 10KHz	300	72	29	3	66
ESR @ 50KHz	285	67	22	2	23
ESR @ 100KHz	280	62	20	2.5	15
ESR @ 500KHz	265	56	18	4	8
ESR @ 1MHz	265	56	17	7	7.5
ESR @ 5MHz	335	72	17	12.5	8
ESR @ 10MHz	560	91	22	20	14

HOW TO ORDER

AVX Styles: SM-1, SM-2, SM-3, SM-4, SM-5, SM-6

SM0	1	7	C	106	M	A	N	650
AVX Style SM0 = Uncoated SM5 = Epoxy Coated	Size See Dimensions chart	Voltage 50V = 5 100V = 1 200V = 2 500V = 7	Temperature Coefficient C0G = A X7R = C Z5U = E	Capacitance Code (2 significant digits + number of zeros) 10 pF = 100 100 pF = 101 1,000 pF = 102 22,000 pF = 223 220,000 pF = 224 1μF = 105 10 μF = 106 100 μF = 107	Capacitance Tolerance C0G: J = ±5% K = ±10% M = ±20% X7R: K = ±10% M = ±20% Z = +80%, -20% Z5U: M = ±20% Z = +80%, -20% P = GMV (+100, -0%)	Test Level A = Standard B = Hi-Rel* 5 = Standard/MIL**	Termination N = Straight Lead J = Leads formed in L = Leads formed out P = P Style Leads Z = Z Style Leads	Height Max Dimension "A" 120 = 0.120" 240 = 0.240" 360 = 0.360" 480 = 0.480" 650 = 0.650"

Note: Capacitors with X7R and Z5U dielectrics are not intended for applications across AC supply mains or AC line filtering with polarity reversal. Contact plant for recommendations.

*Hi-Rel screening for C0G and X7R only. Screening consists of 100% Group A (B Level), Subgroup 1 per MIL-PRF-49470.

**Form, fit & Function equivalent to MIL-PRF-49470 Part. Applies to 50V rated parts only. No Screening.



SMPS Stacked MLC Capacitors



(SM Style) Surface Mount and Thru-Hole Styles (SM0, SM5)

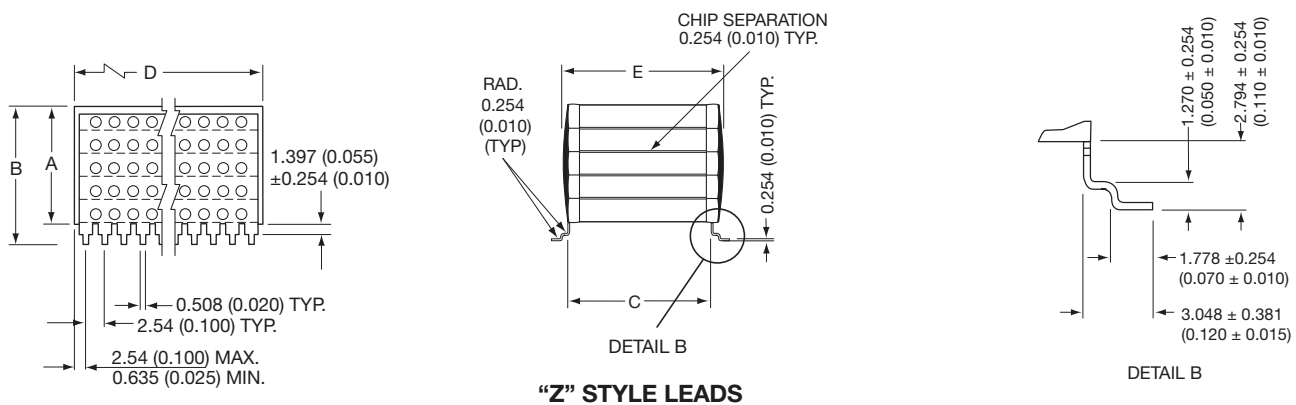
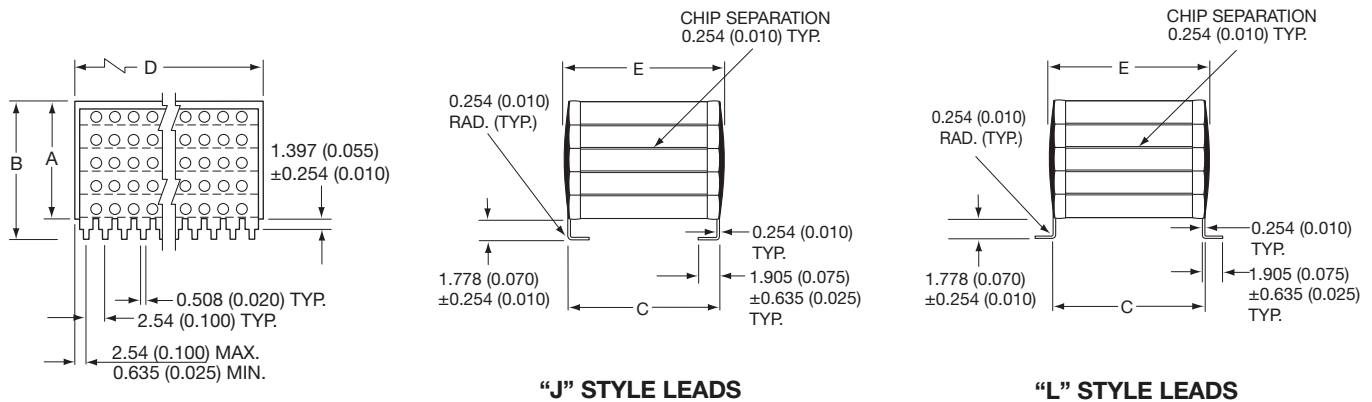
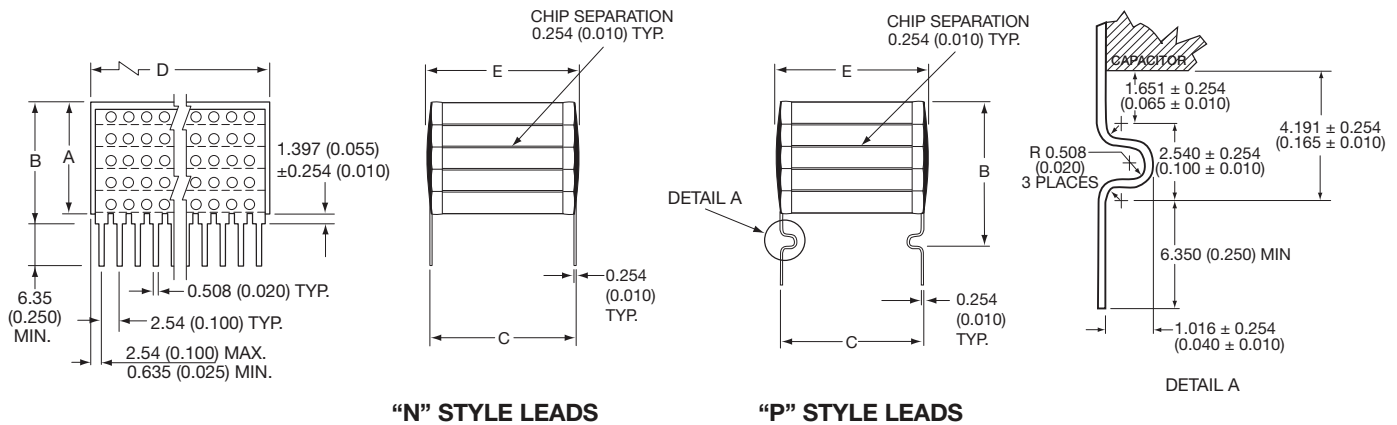

DIMENSIONS

millimeters (inches)

Style	A (max.)	B (max.)	C ±.635 (±0.025)	D ±.635 (±0.025)	E (max.)	No. of Leads per side
SM-1	See page 10 for maximum "A" Dimension	For "N" Style Leads: "A" Dimension Plus 1.651 (0.065) For "J" & "L" Style Leads: "A" Dimension Plus 2.032 (0.080) For "P" Style Leads: "A" Dimension Plus 4.445 (0.175) For "Z" Style Leads: "A" Dimension Plus 3.048 (0.120)	11.4 (0.450)	52.1 (2.050)	12.7 (0.500)	20
SM-2			20.3 (0.800)	38.4 (1.510)	22.1 (0.870)	15
SM-3			11.4 (0.450)	26.7 (1.050)	12.7 (0.500)	10
SM-4			10.2 (0.400)	10.2 (0.400)	11.2 (0.440)	4
SM-5			6.35 (0.250)	6.35 (0.250)	7.62 (0.300)	3
SM-6			31.8 (1.250)	52.1 (2.050)	34.3 (1.350)	20

Note: For SM5 add 0.127 (0.005) to max. and nominal dimensions A, B, D, & E



SMPS Stacked MLC Capacitors



(SM Style)

Max Capacitance (μF) Available Versus Style with Height (A) of 0.120" - 3.05mm

AVX STYLE	SM01 _____ AN120				SM02 _____ AN120				SM03 _____ AN120				SM04 _____ AN120				SM05 _____ AN120				SM06 _____ AN120							
	50V	100V	200V	500V	50V	100V	200V	500V	50V	100V	200V	500V	50V	100V	200V	500V	50V	100V	200V	500V	50V	100V	200V	500V	50V	100V	200V	500V
C0G	1.0	.70	.40	.18	1.2	1.0	.60	.26	.47	.40	.20	.09	.16	.13	.07	.02	.05	.04	.02	.01	3.2	2.4	1.3	.50				
X7R	27	12	7.0	2.6	41	18	11	4.0	18	6.0	3.6	1.3	7.5	1.8	1.1	.40	2.8	.68	.40	.16	80	40	24	9.4				
Z5U	84	32	12	--	110	46	34	--	40	15	6.0	--	12	4.6	3.0	--	4.6	1.8	.72	--	260	140	92	--				

Max Capacitance (μF) Available Versus Style with Height (A) of 0.240" - 6.10mm

AVX STYLE	SM01 _____ AN240				SM02 _____ AN240				SM03 _____ AN240				SM04 _____ AN240				SM05 _____ AN240				SM06 _____ AN240							
	50V	100V	200V	500V	50V	100V	200V	500V	50V	100V	200V	500V	50V	100V	200V	500V	50V	100V	200V	500V	50V	100V	200V	500V	50V	100V	200V	500V
C0G	2.0	1.4	.80	.36	2.4	2.0	1.2	.52	1.0	.80	.40	.18	.32	.26	.14	.05	.10	.08	.05	.02	6.4	4.8	2.6	1.0				
X7R	54	24	14	5.2	82	36	22	8.0	36	12	7.2	2.6	15	3.6	2.2	.80	5.6	1.3	.80	.32	160	80	48	18				
Z5U	160	64	24	--	230	92	68	--	80	30	12	--	24	9.2	6.0	--	9.2	3.6	1.4	--	520	280	180	--				

Max Capacitance (μF) Available Versus Style with Height (A) of 0.360" - 9.14mm

AVX STYLE	SM01 _____ AN360				SM02 _____ AN360				SM03 _____ AN360				SM04 _____ AN360				SM05 _____ AN360				SM06 _____ AN360							
	50V	100V	200V	500V	50V	100V	200V	500V	50V	100V	200V	500V	50V	100V	200V	500V	50V	100V	200V	500V	50V	100V	200V	500V	50V	100V	200V	500V
C0G	3.0	2.1	1.2	.54	3.6	3.0	1.8	.78	1.5	1.2	.60	.27	.48	.39	.21	.07	.15	.12	.07	.03	9.6	7.2	3.9	1.5				
X7R	82	36	21	7.8	120	54	33	12	54	18	10	3.9	22	5.4	3.3	1.2	8.2	2.0	1.2	.48	240	120	72	28				
Z5U	250	96	36	--	350	130	100	--	120	45	18	--	36	13	9.0	--	13	5.4	2.1	--	780	430	270	--				

Max Capacitance (μF) Available Versus Style with Height (A) of 0.480" - 12.2mm

AVX STYLE	SM01 _____ AN480				SM02 _____ AN480				SM03 _____ AN480				SM04 _____ AN480				SM05 _____ AN480				SM06 _____ AN480							
	50V	100V	200V	500V	50V	100V	200V	500V	50V	100V	200V	500V	50V	100V	200V	500V	50V	100V	200V	500V	50V	100V	200V	500V	50V	100V	200V	500V
C0G	4.0	2.8	1.6	.72	4.8	4.0	2.2	1.0	2.0	1.6	.80	.36	.64	.52	.28	.10	.20	.16	.10	.04	12	9.6	5.2	2.0				
X7R	110	48	28	10	160	72	44	16	72	24	14	5.2	30	7.2	4.4	1.6	10	2.7	1.6	.64	320	160	96	37				
Z5U	330	120	48	--	470	180	130	--	160	60	24	--	48	18	12	--	18	7.2	2.8	--	1000	570	360	--				

Max Capacitance (μF) Available Versus Style with Height (A) of 0.650" - 16.5mm

AVX STYLE	SM01 _____ AN650				SM02 _____ AN650				SM03 _____ AN650				SM04 _____ AN650				SM05 _____ AN650				SM06 _____ AN650							
	50V	100V	200V	500V	50V	100V	200V	500V	50V	100V	200V	500V	50V	100V	200V	500V	50V	100V	200V	500V	50V	100V	200V	500V	50V	100V	200V	500V
C0G	5.0	3.5	2.0	.90	6.0	5.0	3.0	1.3	2.5	2.0	1.0	.47	.80	.65	.35	.12	.25	.20	.12	.05	16	12	6.5	2.5				
X7R	130	60	35	13	200	90	55	20	90	30	18	6.5	36	9.0	5.5	2.0	12	3.4	2.0	.80	400	200	120	47				
Z5U	420	160	60	--	590	230	170	--	200	75	30	--	60	23	15	--	23	9.0	3.6	--	1300	720	460	--				

SMPS Stacked MLC Capacitors



(SM Style) SM Military Styles MIL-PRF-49470

AVX IS QUALIFIED TO MIL-PRF-49470/1 AND MIL-PRF-49470/2

The SMPS capacitors are designed for high current, high-power and high-temperature applications. These capacitors have very low ESR (Equivalent Series Resistance) and ESL (Equivalent Series Inductance). SMPS Series capacitors offer design and component engineers a proven technology specifically designed for programs requiring high reliability performance in harsh environments.

MIL-PRF-49470 SMPS Series capacitors are primarily used in input/output filters of high-power and high-voltage power supplies as well as in bus filters and DC snubbers for high power inverters and other high-current applications. These capacitors are available with through-hole and surface mount leads. The operating temperature is -55°C to +125°C. The MIL-PRF-49470 capacitors are preferred over the

DSCC drawing 87106 capacitors. MIL-PRF-49470 specification was created to produce a robust replacement for DSCC 87106. MIL-PRF-49470 offers two product levels.

Level “B” is the standard reliability. Level “T” is the high reliability suitable for space application.

AVX is qualified to supply MIL-PRF-49470/1 parts. These are unencapsulated ceramic dielectric, switch mode power supply capacitors. AVX is also qualified to supply MIL-PRF-49470/2 parts. These are encapsulated ceramic dielectric, switch mode power supply capacitors.

PLEASE CONTACT THE DSCC WEBSITE

[\[http://www.dsccl.dla.mil/Programs/MilSpec/DocSearch.asp\]](http://www.dsccl.dla.mil/Programs/MilSpec/DocSearch.asp) for details on testing, electrical, mechanical and part number options.

PLEASE CONTACT THE DSCC WEBSITE

[\[http://www.dsccl.dla.mil/Programs/QmlQpl/\]](http://www.dsccl.dla.mil/Programs/QmlQpl/) for the latest QPL (Qualified Products List).

HOW TO ORDER

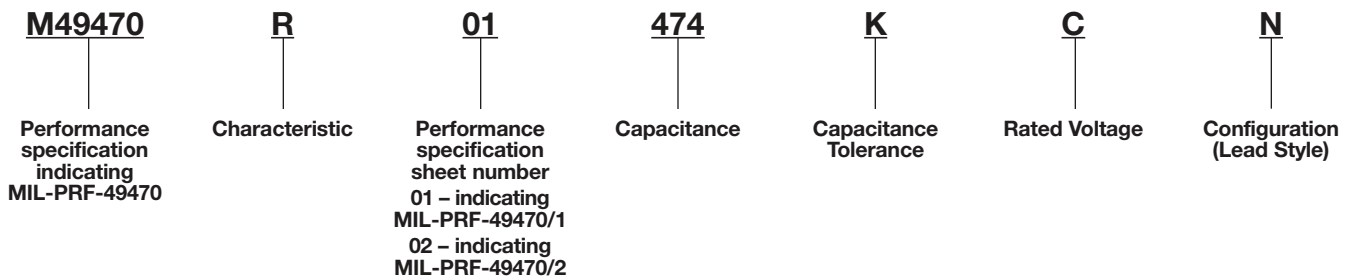

For “T” level parts, replace the “M” in the pin with “T” (for example M49470R01474KCN becomes T49470R01474KCN) MIL-PRF-49470 contains additional capacitors that are not available in 87106, such as additional lead configurations and lower profile parts.

On the pages to follow is the general dimensional outline along with a cross reference from 87106 parts to MIL-PRF-49470 parts.

SMPS Stacked MLC Capacitors



(SM Style) SM Military Styles MIL-PRF-49470/1

MIL-PRF-49470/1

MIL-PRF-49470/1 - capacitor, fixed, ceramic dielectric, switch mode power supply (general purpose and temperature stable), standard reliability and high reliability unencapsulated, Style PS01.

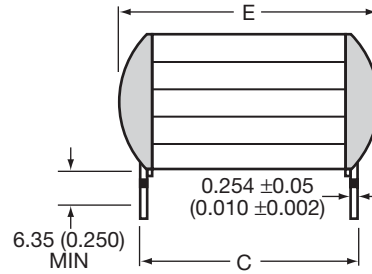
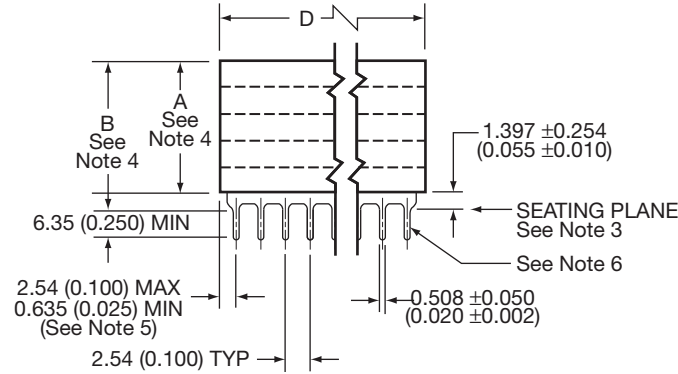

LEAD STYLE N AND A

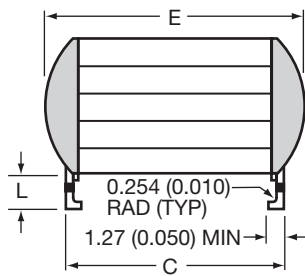

LEAD STYLE J AND C

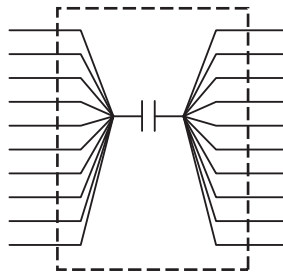

CIRCUIT DIAGRAM

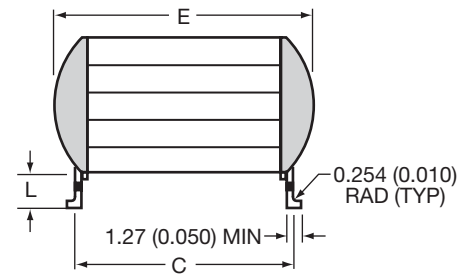

LEAD STYLE L AND B

DIMENSIONS:

millimeters (inches)

Case Code	C ±0.635 (±0.025)	D		E (max.)	Number of Leads per side
		Min.	Max.		
1	11.4 (0.450)	49.5 (1.950)	52.7 (2.075)	12.7 (0.500)	20
2	20.3 (0.800)	36.8 (1.450)	40.0 (1.535)	22.1 (0.870)	15
3	11.4 (0.450)	24.1 (0.950)	27.3 (1.075)	12.7 (0.500)	10
4	10.2 (0.400)	8.89 (0.350)	10.8 (0.425)	11.2 (0.440)	4
5	6.35 (0.250)	6.20 (0.224)	6.97 (0.275)	7.62 (0.300)	3
6	31.8 (1.250)	49.5 (1.950)	52.7 (2.075)	34.3 (1.350)	20

NOTES:

1. Dimensions are in millimeters (inches)
2. Unless otherwise specified, tolerances are 0.254 (±0.010).
3. Lead frame configuration is shown as typical above the seating plane.
4. See table I of MIL-PRF-49470/1 for specific maximum A dimension. For maximum B dimension, add 1.65 (0.065) to the appropriate A dimension. For all lead styles, the number of chips is determined by the capacitance and voltage rating.
5. For case code 5, dimensions shall be 2.54 (0.100) maximum and 0.305 (0.012) minimum.
6. Lead alignment within pin rows shall be within ±0.10 (0.005).



SMPS Stacked MLC Capacitors



(SM Style) SM Military Styles MIL-PRF-49470/2

MIL-PRF-49470/2

MIL-PRF-49470/2 - capacitor, fixed, ceramic dielectric, switch mode power supply (general purpose and temperature stable), standard reliability and high reliability encapsulated, Style PS02.

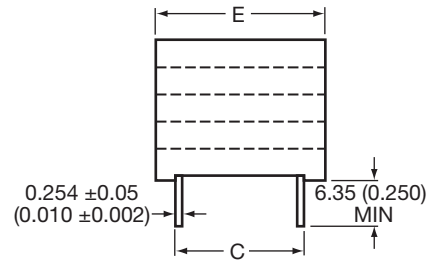
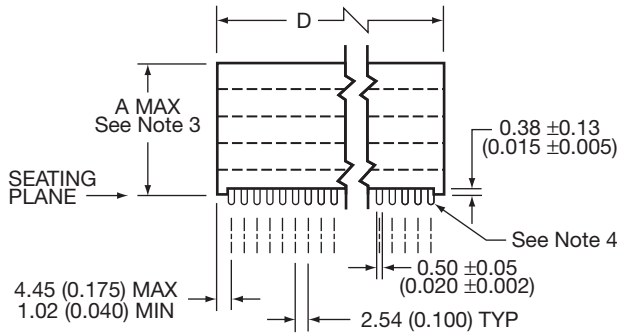

LEAD STYLE N AND A

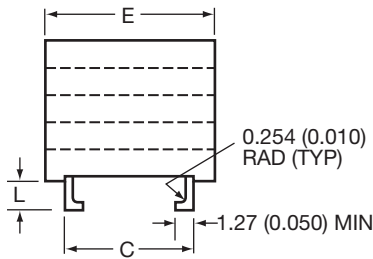

LEAD STYLE J AND C

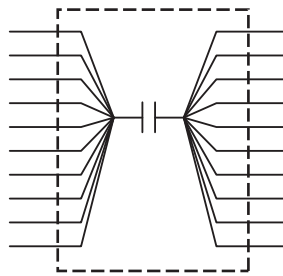

CIRCUIT DIAGRAM

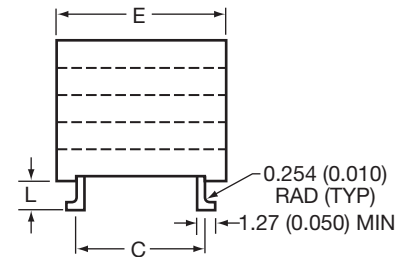

LEAD STYLE L AND B

DIMENSIONS:

millimeters (inches)

Case Code	C ±0.635 (±0.025)	D ±0.635 (±0.025)	E (max)	Number of Leads per side
1	11.4 (0.450)	54.7 (2.155)	14.7 (0.580)	20
2	20.3 (0.800)	41.0 (1.615)	24.1 (0.950)	15
3	11.4 (0.450)	29.3 (1.155)	14.7 (0.580)	10
4	10.2 (0.400)	12.3 (0.485)	12.3 (0.485)	4
5	6.35 (0.250)	9.02 (0.355)	9.02 (0.355)	3
6	31.8 (1.250)	54.7 (2.155)	36.3 (1.430)	20

NOTES:

1. Dimensions are in millimeters (inches)
2. Unless otherwise specified, tolerances are 0.254 (±0.001).
3. See table I of MIL-PRF-49470/2 for specific maximum A dimension. For all lead styles, the number of chips is determined by the capacitance and voltage rating.
4. Lead alignment within pin rows shall be within ±0.10 (0.004).



SMPS Stacked MLC Capacitors



(SM Style) SM Military Styles MIL-PRF-49470

87106-	MIL-PRF-49470 PIN	AVX PART NUMBER	CAP (µF)	TOL	CASE CODE	VOLT (VDC)
1	M49470X01105KAN	SM055C105KHN120	1.0	±10%	5	50
2	M49470X01105MAN	SM055C105MHN120	1.0	±20%	5	50
3	M49470X01125KAN	SM055C125KHN120	1.2	±10%	5	50
4	M49470X01125MAN	SM055C125MHN120	1.2	±20%	5	50
5	M49470X01155KAN	SM055C155KHN240	1.5	±10%	5	50
6	M49470X01155MAN	SM055C155MHN240	1.5	±20%	5	50
7	M49470X01185KAN	SM055C185KHN240	1.8	±10%	5	50
8	M49470X01185MAN	SM055C185MHN240	1.8	±20%	5	50
9	M49470X01225KAN	SM055C225KHN240	2.2	±10%	5	50
10	M49470X01225MAN	SM055C225MHN240	2.2	±20%	5	50
11	M49470X01275KAN	SM055C275KHN360	2.7	±10%	5	50
12	M49470X01275MAN	SM055C275MHN360	2.7	±20%	5	50
13	M49470X01335KAN	SM055C335KHN360	3.3	±10%	5	50
14	M49470X01335MAN	SM055C335MHN360	3.3	±20%	5	50
15	M49470X01395KAN	SM055C395KHN480	3.9	±10%	5	50
16	M49470X01395MAN	SM055C395MHN480	3.9	±20%	5	50
17	M49470X01475KAN	SM055C475KHN480	4.7	±10%	5	50
18	M49470X01475MAN	SM055C475MHN480	4.7	±20%	5	50
	M49470X01475KAA	SM045C475KHN240	4.7	±10%	4	50
	M49470X01475MAA	SM045C475MHN240	4.7	±20%	4	50
19	M49470X01565KAN	SM055C565KHN650	5.6	±10%	5	50
20	M49470X01565MAN	SM055C565MHN650	5.6	±20%	5	50
	M49470X01565KAA	SM045C565KHN240	5.6	±10%	4	50
	M49470X01565MAA	SM045C565MHN240	5.6	±20%	4	50
21	M49470X01825KAN	SM045C825KHN360	8.2	±10%	4	50
22	M49470X01825MAN	SM045C825MHN360	8.2	±20%	4	50
23	M49470X01106KAN	SM045C106KHN480	10	±10%	4	50
24	M49470X01106MAN	SM045C106MHN480	10	±20%	4	50
25	M49470X01126KAN	SM045C126KHN480	12	±10%	4	50
26	M49470X01126MAN	SM045C126MHN480	12	±20%	4	50
27	M49470X01156KAN	SM045C156KHN650	15	±10%	4	50
28	M49470X01156MAN	SM045C156MHN650	15	±20%	4	50
	M49470X01156KAA	SM035C156KHN240	15	±10%	3	50
	M49470X01156MAA	SM035C156MHN240	15	±20%	3	50
29	M49470X01186KAN	SM035C186KHN240	18	±10%	3	50
30	M49470X01186MAN	SM035C186MHN240	18	±20%	3	50
31	M49470X01226KAN	SM035C226KHN360	22	±10%	3	50
32	M49470X01226MAN	SM035C226MHN360	22	±20%	3	50
33	M49470X01276KAN	SM035C276KHN360	27	±10%	3	50
34	M49470X01276MAN	SM035C276MHN360	27	±20%	3	50
35	M49470X01336KAN	SM035C336KHN360	33	±10%	3	50
36	M49470X01336MAN	SM035C336MHN360	33	±20%	3	50
37	M49470X01396KAN	SM035C396KHN480	39	±10%	3	50
38	M49470X01396MAN	SM035C396MHN480	39	±20%	3	50
39	M49470X01476KAN	SM035C476KHN650	47	±10%	3	50
40	M49470X01476MAN	SM035C476MHN650	47	±20%	3	50
	M49470X01476KAA	SM025C476KHN240	47	±10%	2	50
	M49470X01476MAA	SM025C476MHN240	47	±20%	2	50
41	M49470X01686KAN	SM015C686KHN480	68	±10%	1	50
42	M49470X01686MAN	SM015C686MHN480	68	±20%	1	50
	M49470X01686KAA	SM025C686KHN360	68	±10%	2	50
	M49470X01686MAA	SM025C686MHN360	68	±20%	2	50
43	M49470X01826KAN	SM015C826KHN480	82	±10%	1	50
44	M49470X01826MAN	SM015C826MHN480	82	±20%	1	50
	M49470X01826KAA	SM025C826KHN360	82	±10%	2	50
	M49470X01826MAA	SM025C826MHN360	82	±20%	2	50
45	M49470X01107KAN	SM015C107KHN650	100	±10%	1	50
46	M49470X01107MAN	SM015C107MHN650	100	±20%	1	50
	M49470X01107KAA	SM025C107KHN480	100	±10%	2	50
	M49470X01107MAA	SM025C107MHN480	100	±20%	2	50
47	M49470X01157KAN	SM025C157KHN650	150	±10%	2	50
48	M49470X01157MAN	SM025C157MHN650	150	±20%	2	50

87106-	MIL-PRF-49470 PIN	AVX PART NUMBER	CAP (µF)	TOL	CASE CODE	VOLT (VDC)
49	M49470X01187KAN	SM065C187KHN480	180	±10%	6	50
50	M49470X01187MAN	SM065C187MHN480	180	±20%	6	50
51	M49470X01227KAN	SM065C227KHN480	220	±10%	6	50
52	M49470X01227MAN	SM065C227MHN480	220	±20%	6	50
53	M49470X01277KAN	SM065C277KHN650	270	±10%	6	50
54	M49470X01277MAN	SM065C277MHN650	270	±20%	6	50
55	M49470X01684KBN	SM051C684KHN120	0.68	±10%	5	100
56	M49470X01684MBN	SM051C684MHN120	0.68	±20%	5	100
57	M49470X01824KBN	SM051C824KHN240	0.82	±10%	5	100
58	M49470X01824MBN	SM051C824MHN240	0.82	±20%	5	100
59	M49470X01105KBN	SM051C105KHN240	1.0	±10%	5	100
60	M49470X01105MBN	SM051C105MHN240	1.0	±20%	5	100
61	M49470X01125KBN	SM051C125KHN240	1.2	±10%	5	100
62	M49470X01125MBN	SM051C125MHN240	1.2	±20%	5	100
63	M49470X01155KBN	SM051C155KHN360	1.5	±10%	5	100
64	M49470X01155MBN	SM051C155MHN360	1.5	±20%	5	100
65	M49470X01185KBN	SM051C185KHN360	1.8	±10%	5	100
66	M49470X01185MBN	SM051C185MHN360	1.8	±20%	5	100
67	M49470X01225KBN	SM051C225KHN480	2.2	±10%	5	100
68	M49470X01225MBN	SM051C225MHN480	2.2	±20%	5	100
	M49470X01225KBA	SM041C225KHN240	2.2	±10%	4	100
	M49470X01225MBA	SM041C225MHN240	2.2	±20%	4	100
69	M49470X01275KBN	SM051C275KHN480	2.7	±10%	5	100
70	M49470X01275MBN	SM051C275MHN480	2.7	±20%	5	100
71	M49470X01335KBN	SM051C335KHN650	3.3	±10%	5	100
72	M49470X01335MBN	SM051C335MHN650	3.3	±20%	5	100
	M49470X01335KBA	SM041C335KHN240	3.3	±10%	4	100
	M49470X01335MBA	SM041C335MHN240	3.3	±20%	4	100
73	M49470X01395KBN	SM041C395KHN360	3.9	±10%	4	100
74	M49470X01395MBN	SM041C395MHN360	3.9	±20%	4	100
75	M49470X01475KBN	SM041C475KHN360	4.7	±10%	4	100
76	M49470X01475MBN	SM041C475MHN360	4.7	±20%	4	100
77	M49470X01565KBN	SM041C565KHN480	5.6	±10%	4	100
78	M49470X01565MBN	SM041C565MHN480	5.6	±20%	4	100
79	M49470X01685KBN	SM041C685KHN480	6.8	±10%	4	100
80	M49470X01685MBN	SM041C685MHN480	6.8	±20%	4	100
81	M49470X01825KBN	SM041C825KHN650	8.2	±10%	4	100
82	M49470X01825MBN	SM041C825MHN650	8.2	±20%	4	100
	M49470X01825KBA	SM031C825KHN240	8.2	±10%	3	100
	M49470X01825MBA	SM031C825MHN240	8.2	±20%	3	100
83	M49470X01126KBN	SM031C126KHN240	12	±10%	3	100
84	M49470X01126MBN	SM031C126MHN240	12	±20%	3	100
85	M49470X01156KBN	SM031C156KHN360	15	±10%	3	100
86	M49470X01156MBN	SM031C156MHN360	15	±20%	3	100
87	M49470X01186KBN	SM031C186KHN360	18	±10%	3	100
88	M49470X01186MBN	SM031C186MHN360	18	±20%	3	100
89	M49470X01226KBN	SM031C226KHN480	22	±10%	3	100
90	M49470X01226MBN	SM031C226MHN480	22	±20%	3	100
91	M49470X01276KBN	SM031C276KHN650	27	±10%	3	100
92	M49470X01276MBN	SM031C276MHN650	27	±20%	3	100
	M49470X01276KBA	SM021C276KHN240	27	±10%	2	100
	M49470X01276MBA	SM021C276MHN240	27	±20%	2	100
93	M49470X01336KBN	SM011C336KHN360	33	±10%	1	100
94	M49470X01336MBN	SM011C336MHN360	33	±20%	1	100
	M49470X01336KBA	SM021C336KHN240	33	±10%	2	100
	M49470X01336MBA	SM021C336MHN240	33	±20%	2	100
95	M49470X01396KBN	SM011C396KHN480	39	±10%	1	100
96	M49470X01396MBN	SM011C396MHN480	39	±20%	1	100
	M49470X01396KBA	SM021C396KHN360	39	±10%	2	100
	M49470X01396MBA	SM021C396MHN360	39	±20%	2	100
97	M49470X01476KBN	SM011C476KHN480	47	±10%	1	100
98	M49470X01476MBN	SM011C476MHN480	47	±20%	1	100



SMPS Stacked MLC Capacitors

(SM Style) SM Military Styles MIL-PRF-49470



87106-	MIL-PRF-49470 PIN	AVX PART NUMBER	CAP (µF)	TOL	CASE CODE	VOLT (VDC)
	M49470X01476KBA	SM021C476KHN360	47	±10%	2	100
	M49470X01476MBA	SM021C476MHN360	47	±20%	2	100
99	M49470X01566KBN	SM011C566KHN650	56	±10%	1	100
100	M49470X01566MBN	SM011C566MHN650	56	±20%	1	100
101	M49470X01686KBN	SM021C686KHN480	68	±10%	2	100
102	M49470X01686MBN	SM021C686MHN480	68	±20%	2	100
103	M49470X01826KBN	SM021C826KHN650	82	±10%	2	100
104	M49470X01826MBN	SM021C826MHN650	82	±20%	2	100
105	M49470X01107KBN	SM061C107KHN360	100	±10%	6	100
106	M49470X01107MBN	SM061C107MHN360	100	±20%	6	100
107	M49470X01127KBN	SM061C127KHN360	120	±10%	6	100
108	M49470X01127MBN	SM061C127MHN360	120	±20%	6	100
109	M49470X01157KBN	SM061C157KHN480	150	±10%	6	100
110	M49470X01157MBN	SM061C157MHN480	150	±20%	6	100
111	M49470X01187KBN	SM061C187KHN650	180	±10%	6	100
112	M49470X01187MBN	SM061C187MHN650	180	±20%	6	100
113	M49470R01474KCN	SM052C474KHN240	0.47	±10%	5	200
114	M49470R01474MCN	SM052C474MHN240	0.47	±20%	5	200
115	M49470R01564KCN	SM052C564KHN240	0.56	±10%	5	200
116	M49470R01564MCN	SM052C564MHN240	0.56	±20%	5	200
117	M49470R01684KCN	SM052C684KHN360	0.68	±10%	5	200
118	M49470R01684MCN	SM052C684MHN360	0.68	±20%	5	200
119	M49470R01824KCN	SM052C824KHN360	0.82	±10%	5	200
120	M49470R01824MCN	SM052C824MHN360	0.82	±20%	5	200
121	M49470R01105KCN	SM052C105KHN480	1.0	±10%	5	200
122	M49470R01105MCN	SM052C105MHN480	1.0	±20%	5	200
	M49470R01105KCA	SM042C105KHN120	1.0	±10%	4	200
	M49470R01105MCA	SM042C105MHN120	1.0	±20%	4	200
123	M49470R01125KCN	SM052C125KHN480	1.2	±10%	5	200
124	M49470R01125MCN	SM052C125MHN480	1.2	±20%	5	200
	M49470R01125KCA	SM042C125KHN240	1.2	±10%	4	200
	M49470R01125MCA	SM042C125MHN240	1.2	±20%	4	200
125	M49470R01155KCN	SM052C155KHN650	1.5	±10%	5	200
126	M49470R01155MCN	SM052C155MHN650	1.5	±20%	5	200
	M49470R01155KCA	SM042C155KHN240	1.5	±10%	4	200
	M49470R01155MCA	SM042C155MHN240	1.5	±20%	4	200
127	M49470R01185KCN	SM042C185KHN360	1.8	±10%	4	200
128	M49470R01185MCN	SM042C185MHN360	1.8	±20%	4	200
129	M49470R01225KCN	SM042C225KHN360	2.2	±10%	4	200
130	M49470R01225MCN	SM042C225MHN360	2.2	±20%	4	200
131	M49470R01275KCN	SM042C275KHN480	2.7	±10%	4	200
132	M49470R01275MCN	SM042C275MHN480	2.7	±20%	4	200
133	M49470R01335KCN	SM042C335KHN480	3.3	±10%	4	200
134	M49470R01335MCN	SM042C335MHN480	3.3	±20%	4	200
135	M49470R01395KCN	SM042C395KHN650	3.9	±10%	4	200
136	M49470R01395MCN	SM042C395MHN650	3.9	±20%	4	200
	M49470R01395KCA	SM032C395KHN240	3.9	±10%	3	200
	M49470R01395MCA	SM032C395MHN240	3.9	±20%	3	200
137	M49470R01475KCN	SM032C475KHN240	4.7	±10%	3	200
138	M49470R01475MCN	SM032C475MHN240	4.7	±20%	3	200
139	M49470R01565KCN	SM032C565KHN240	5.6	±10%	3	200
140	M49470R01565MCN	SM032C565MHN240	5.6	±20%	3	200
141	M49470R01685KCN	SM032C685KHN360	6.8	±10%	3	200
142	M49470R01685MCN	SM032C685MHN360	6.8	±20%	3	200
143	M49470R01825KCN	SM032C825KHN360	8.2	±10%	3	200
144	M49470R01825MCN	SM032C825MHN360	8.2	±20%	3	200
145	M49470R01106KCN	SM032C106KHN480	10	±10%	3	200
146	M49470R01106MCN	SM032C106MHN480	10	±20%	3	200
147	M49470R01126KCN	SM032C126KHN650	12	±10%	3	200
148	M49470R01126MCN	SM032C126MHN650	12	±20%	3	200
	M49470R01126KCA	SM022C126KHN240	12	±10%	2	200
	M49470R01126MCA	SM022C126MHN240	12	±20%	2	200

87106-	MIL-PRF-49470 PIN	AVX PART NUMBER	CAP (µF)	TOL	CASE CODE	VOLT (VDC)
149	M49470R01156KCN	SM012C156KHN360	15	±10%	1	200
150	M49470R01156MCN	SM012C156MHN360	15	±20%	1	200
	M49470R01156KCA	SM022C156KHN240	15	±10%	2	200
	M49470R01156MCA	SM022C156MHN240	15	±20%	2	200
151	M49470R01186KCN	SM012C186KHN480	18	±10%	1	200
152	M49470R01186MCN	SM012C186MHN480	18	±20%	1	200
	M49470R01186KCA	SM022C186KHN360	18	±10%	2	200
	M49470R01186MCA	SM022C186MHN360	18	±20%	2	200
153	M49470R01226KCN	SM012C226KHN650	22	±10%	1	200
154	M49470R01226MCN	SM012C226MHN650	22	±20%	1	200
	M49470R01226KCA	SM022C226KHN360	22	±10%	2	200
	M49470R01226MCA	SM022C226MHN360	22	±20%	2	200
155	M49470R01276KCN	SM012C276KHN650	27	±10%	1	200
156	M49470R01276MCN	SM012C276MHN650	27	±20%	1	200
	M49470R01276KCA	SM022C276KHN480	27	±10%	2	200
	M49470R01276MCA	SM022C276MHN480	27	±20%	2	200
157	M49470R01336KCN	SM022C336KHN480	33	±10%	2	200
158	M49470R01336MCN	SM022C336MHN480	33	±20%	2	200
159	M49470R01396KCN	SM022C396KHN650	39	±10%	2	200
160	M49470R01396MCN	SM022C396MHN650	39	±20%	2	200
161	M49470R01476KCN	SM062C476KHN240	47	±10%	6	200
162	M49470R01476MCN	SM062C476MHN240	47	±20%	6	200
163	M49470R01566KCN	SM062C566KHN360	56	±10%	6	200
164	M49470R01566MCN	SM062C566MHN360	56	±20%	6	200
165	M49470R01686KCN	SM062C686KHN360	68	±10%	6	200
166	M49470R01686MCN	SM062C686MHN360	68	±20%	6	200
167	M49470R01826KCN	SM062C826KHN480	82	±10%	6	200
168	M49470R01826MCN	SM062C826MHN480	82	±20%	6	200
169	M49470R01107KCN	SM062C107KHN650	100	±10%	6	200
170	M49470R01107MCN	SM062C107MHN650	100	±20%	6	200
171	M49470R01127KCN	SM062C127KHN650	120	±10%	6	200
172	M49470R01127MCN	SM062C127MHN650	120	±20%	6	200
173	M49470Q01154KEN	SM057C154KHN120	0.15	±10%	5	500
174	M49470Q01154MEN	SM057C154MHN120	0.15	±20%	5	500
175	M49470Q01184KEN	SM057C184KHN240	0.18	±10%	5	500
176	M49470Q01184MEN	SM057C184MHN240	0.18	±20%	5	500
177	M49470Q01224KEN	SM057C224KHN240	0.22	±10%	5	500
178	M49470Q01224MEN	SM057C224MHN240	0.22	±20%	5	500
179	M49470Q01274KEN	SM057C274KHN240	0.27	±10%	5	500
180	M49470Q01274MEN	SM057C274MHN240	0.27	±20%	5	500
181	M49470Q01334KEN	SM057C334KHN360	0.33	±10%	5	500
182	M49470Q01334MEN	SM057C334MHN360	0.33	±20%	5	500
183	M49470Q01394KEN	SM057C394KHN360	0.39	±10%	5	500
184	M49470Q01394MEN	SM057C394MHN360	0.39	±20%	5	500
185	M49470Q01474KEN	SM057C474KHN360	0.47	±10%	5	500
186	M49470Q01474MEN	SM057C474MHN360	0.47	±20%	5	500
187	M49470Q01564KEN	SM057C564KHN480	0.56	±10%	5	500
188	M49470Q01564MEN	SM057C564MHN480	0.56	±20%	5	500
	M49470Q01564KEA	SM047C564KHN240	0.56	±10%	4	500
	M49470Q01564MEA	SM047C564MHN240	0.56	±20%	4	500
189	M49470Q01684KEN	SM057C684KHN650	0.68	±10%	5	500
190	M49470Q01684MEN	SM057C684MHN650	0.68	±20%	5	500
	M49470Q01684KEA	SM047C684KHN360	0.68	±10%	4	500
	M49470Q01684MEA	SM047C684MHN360	0.68	±20%	4	500
191	M49470Q01105KEN	SM047C105KHN360	1.0	±10%	4	500
192	M49470Q01105MEN	SM047C105MHN360	1.0	±20%	4	500
193	M49470Q01125KEN	SM047C125KHN360	1.2	±10%	4	500
194	M49470Q01125MEN	SM047C125MHN360	1.2	±20%	4	500
195	M49470Q01155KEN	SM047C155KHN480	1.5	±10%	4	500
196	M49470Q01155MEN	SM047C155MHN480	1.5	±20%	4	500
197	M49470Q01185KEN	SM047C185KHN650	1.8	±10%	4	500
198	M49470Q01185MEN	SM047C185MHN650	1.8	±20%	4	500



SMPS Stacked MLC Capacitors

(SM Style) SM Military Styles MIL-PRF-49470



87106-	MIL-PRF-49470 PIN	AVX PART NUMBER	CAP (µF)	TOL	CASE CODE	VOLT (VDC)
	M49470Q01185KEA	SM037C185KHN240	1.8	±10%	3	500
	M49470Q01185MEA	SM037C185MHN240	1.8	±20%	3	500
199	M49470Q01275KEN	SM037C275KHN360	2.7	±10%	3	500
200	M49470Q01275MEN	SM037C275MHN360	2.7	±20%	3	500
201	M49470Q01335KEN	SM037C335KHN360	3.3	±10%	3	500
202	M49470Q01335MEN	SM037C335MHN360	3.3	±20%	3	500
203	M49470Q01395KEN	SM037C395KHN360	3.9	±10%	3	500
204	M49470Q01395MEN	SM037C395MHN360	3.9	±20%	3	500
205	M49470Q01475KEN	SM037C475KHN480	4.7	±10%	3	500
206	M49470Q01475MEN	SM037C475MHN480	4.7	±20%	3	500
207	M49470Q01565KEN	SM037C565KHN650	5.6	±10%	3	500
208	M49470Q01565MEN	SM037C565MHN650	5.6	±20%	3	500
	M49470Q01565KEA	SM027C565KHN240	5.6	±10%	2	500
	M49470Q01565MEA	SM027C565MHN240	5.6	±20%	2	500
209	M49470Q01825KEN	SM017C825KHN480	8.2	±10%	1	500
210	M49470Q01825MEN	SM017C825MHN480	8.2	±20%	1	500
	M49470Q01825KEA	SM027C825KHN360	8.2	±10%	2	500
	M49470Q01825MEA	SM027C825MHN360	8.2	±20%	2	500
211	M49470Q01106KEN	SM017C106KHN480	10	±10%	1	500
212	M49470Q01106MEN	SM017C106MHN480	10	±20%	1	500
	M49470Q01106KEA	SM027C106KHN360	10	±10%	2	500
	M49470Q01106MEA	SM027C106MHN360	10	±20%	2	500
213	M49470Q01126KEN	SM017C126KHN650	12	±10%	1	500
214	M49470Q01126MEN	SM017C126MHN650	12	±20%	1	500
	M49470Q01126KEA	SM027C126KHN480	12	±10%	2	500
	M49470Q01126MEA	SM027C126MHN480	12	±20%	2	500
215	M49470Q01186KEN	SM027C186KHN650	18	±10%	2	500
216	M49470Q01186MEN	SM027C186MHN650	18	±20%	2	500
217	M49470Q01276KEN	SM067C276KHN360	27	±10%	6	500
218	M49470Q01276MEN	SM067C276MHN360	27	±20%	6	500
219	M49470Q01336KEN	SM067C336KHN480	33	±10%	6	500
220	M49470Q01336MEN	SM067C336MHN480	33	±20%	6	500
221	M49470Q01396KEN	SM067C396KHN650	39	±10%	6	500
222	M49470Q01396MEN	SM067C396MHN650	39	±20%	6	500
223	M49470X01685KAN	SM045C685KHN360	6.8	±10%	4	50
224	M49470X01685MAN	SM045C685MHN360	6.8	±20%	4	50
225	M49470X01566KAN	SM015C566KHN360	56	±10%	1	50
226	M49470X01566MAN	SM015C566MHN360	56	±20%	1	50
	M49470X01566KAA	SM025C566KHN240	56	±10%	2	50
	M49470X01566MAA	SM025C566MHN240	56	±20%	2	50
227	M49470X01127KAN	SM025C127KHN480	120	±10%	2	50
228	M49470X01127MAN	SM025C127MHN480	120	±20%	2	50
229	M49470X01106KBN	SM031C106KHN240	10	±10%	3	100
230	M49470X01106MBN	SM031C106MHN240	10	±20%	3	100
231	M49470Q01824KEN	SM047C824KHN360	0.82	±10%	4	500
232	M49470Q01824MEN	SM047C824MHN360	0.82	±20%	4	500
233	M49470Q01225KEN	SM037C225KHN240	2.2	±10%	3	500
234	M49470Q01225MEN	SM037C225MHN240	2.2	±20%	3	500
235	M49470Q01685KEN	SM017C685KHN480	6.8	±10%	1	500
236	M49470Q01685MEN	SM017C685MHN480	6.8	±20%	1	500
	M49470Q01685KEA	SM027C685KHN240	6.8	±10%	2	500
	M49470Q01685MEA	SM027C685MHN240	6.8	±20%	2	500
237	M49470Q01156KEN	SM027C156KHN650	15	±10%	2	500
238	M49470Q01156MEN	SM027C156MHN650	15	±20%	2	500
239	M49470Q01226KEN	SM067C226KHN360	22	±10%	6	500
240	M49470Q01226MEN	SM067C226MHN360	22	±20%	6	500
241	M49470X01105KAJ	SM055C105KHJ120	1.0	±10%	5	50
242	M49470X01105MAJ	SM055C105MHJ120	1.0	±20%	5	50
243	M49470X01125KAJ	SM055C125KHJ120	1.2	±10%	5	50
244	M49470X01125MAJ	SM055C125MHJ120	1.2	±20%	5	50
245	M49470X01155KAJ	SM055C155KHJ240	1.5	±10%	5	50
246	M49470X01155MAJ	SM055C155MHJ240	1.5	±20%	5	50

87106-	MIL-PRF-49470 PIN	AVX PART NUMBER	CAP (µF)	TOL	CASE CODE	VOLT (VDC)
247	M49470X01185KAJ	SM055C185KHJ240	1.8	±10%	5	50
248	M49470X01185MAJ	SM055C185MHJ240	1.8	±20%	5	50
249	M49470X01225KAJ	SM055C225KHJ240	2.2	±10%	5	50
250	M49470X01225MAJ	SM055C225MHJ240	2.2	±20%	5	50
251	M49470X01275KAJ	SM055C275KHJ360	2.7	±10%	5	50
252	M49470X01275MAJ	SM055C275MHJ360	2.7	±20%	5	50
253	M49470X01335KAJ	SM055C335KHJ360	3.3	±10%	5	50
254	M49470X01335MAJ	SM055C335MHJ360	3.3	±20%	5	50
255	M49470X01395KAJ	SM055C395KHJ480	3.9	±10%	5	50
256	M49470X01395MAJ	SM055C395MHJ480	3.9	±20%	5	50
257	M49470X01475KAJ	SM055C475KHJ480	4.7	±10%	5	50
258	M49470X01475MAJ	SM055C475MHJ480	4.7	±20%	5	50
	M49470X01475KAC	SM045C475KHJ240	4.7	±10%	4	50
	M49470X01475MAC	SM045C475MHJ240	4.7	±20%	4	50
259	M49470X01565KAJ	SM055C565KHJ650	5.6	±10%	5	50
260	M49470X01565MAJ	SM055C565MHJ650	5.6	±20%	5	50
	M49470X01565KAC	SM045C565KHJ240	5.6	±10%	4	50
	M49470X01565MAC	SM045C565MHJ240	5.6	±10%	4	50
261	M49470X01685KAJ	SM045C685KHJ360	6.8	±10%	4	50
262	M49470X01685MAJ	SM045C685MHJ360	6.8	±20%	4	50
263	M49470X01825KAJ	SM045C825KHJ360	8.2	±10%	4	50
264	M49470X01825MAJ	SM045C825MHJ360	8.2	±20%	4	50
265	M49470X01106KAJ	SM045C106KHJ480	10	±10%	4	50
266	M49470X01106MAJ	SM045C106MHJ480	10	±20%	4	50
267	M49470X01126KAJ	SM045C126KHJ480	12	±10%	4	50
268	M49470X01126MAJ	SM045C126MHJ480	12	±20%	4	50
269	M49470X01156KAJ	SM045C156KHJ650	15	±10%	4	50
270	M49470X01156MAJ	SM045C156MHJ650	15	±20%	4	50
	M49470X01156KAC	SM035C156KHJ240	15	±10%	3	50
	M49470X01156MAC	SM035C156MHJ240	15	±20%	3	50
271	M49470X01186KAJ	SM035C186KHJ240	18	±10%	3	50
272	M49470X01186MAJ	SM035C186MHJ240	18	±20%	3	50
273	M49470X01226KAJ	SM035C226KHJ360	22	±10%	3	50
274	M49470X01226MAJ	SM035C226MHJ360	22	±20%	3	50
275	M49470X01276KAJ	SM035C276KHJ360	27	±10%	3	50
276	M49470X01276MAJ	SM035C276MHJ360	27	±20%	3	50
277	M49470X01336KAJ	SM035C336KHJ360	33	±10%	3	50
278	M49470X01336MAJ	SM035C336MHJ360	33	±20%	3	50
279	M49470X01396KAJ	SM035C396KHJ480	39	±10%	3	50
280	M49470X01396MAJ	SM035C396MHJ480	39	±20%	3	50
281	M49470X01476KAJ	SM035C476KHJ650	47	±10%	3	50
282	M49470X01476MAJ	SM035C476MHJ650	47	±20%	3	50
	M49470X01476KAC	SM025C476KHJ240	47	±10%	2	50
	M49470X01476MAC	SM025C476MHJ240	47	±20%	2	50
283	M49470X01566KAJ	SM015C566KHJ360	56	±10%	1	50
284	M49470X01566MAJ	SM015C566MHJ360	56	±20%	1	50
	M49470X01566KAC	SM025C566KHJ240	56	±10%	2	50
	M49470X01566MAC	SM025C566MHJ240	56	±20%	2	50
285	M49470X01686KAJ	SM015C686KHJ480	68	±10%	1	50
286	M49470X01686MAJ	SM015C686MHJ480	68	±20%	1	50
	M49470X01686KAC	SM025C686KHJ360	68	±10%	2	50
	M49470X01686MAC	SM025C686MHJ360	68	±20%	2	50
287	M49470X01826KAJ	SM015C826KHJ480	82	±10%	1	50
288	M49470X01826MAJ	SM015C826MHJ480	82	±20%	1	50
	M49470X01826KAC	SM025C826KHJ360	82	±10%	2	50
	M49470X01826MAC	SM025C826MHJ360	82	±20%	2	50
289	M49470X01107KAJ	SM015C107KHJ650	100	±10%	1	50
290	M49470X01107MAJ	SM015C107MHJ650	100	±20%	1	50
	M49470X01107KAC	SM025C107KHJ480	100	±10%	2	50
	M49470X01107MAC	SM025C107MHJ480	100	±20%	2	50
291	M49470X01127KAJ	SM025C127KHJ480	120	±10%	2	50
292	M49470X01127MAJ	SM025C127MHJ480	120	±20%	2	50



SMPS Stacked MLC Capacitors

(SM Style) SM Military Styles MIL-PRF-49470



87106-	MIL-PRF-49470 PIN	AVX PART NUMBER	CAP (µF)	TOL	CASE CODE	VOLT (VDC)
293	M49470X01157KAJ	SM025C157KHJ650	150	±10%	2	50
294	M49470X01157MAJ	SM025C157MHJ650	150	±20%	2	50
295	M49470X01187KAJ	SM065C187KHJ480	180	±10%	6	50
296	M49470X01187MAJ	SM065C187MHJ480	180	±20%	6	50
297	M49470X01227KAJ	SM065C227KHJ480	220	±10%	6	50
298	M49470X01227MAJ	SM065C227MHJ480	220	±20%	6	50
299	M49470X01277KAJ	SM065C277KHJ650	270	±10%	6	50
300	M49470X01277MAJ	SM065C277MHJ650	270	±20%	6	50
301	M49470X01684KBJ	SM051C684KHJ120	0.68	±10%	5	100
302	M49470X01684MBJ	SM051C684MHJ120	0.68	±20%	5	100
303	M49470X01824KBJ	SM051C824KHJ240	0.82	±10%	5	100
304	M49470X01824MBJ	SM051C824MHJ240	0.82	±20%	5	100
305	M49470X01105KBJ	SM051C105KHJ240	1.0	±10%	5	100
306	M49470X01105MBJ	SM051C105MHJ240	1.0	±20%	5	100
307	M49470X01125KBJ	SM051C125KHJ240	1.2	±10%	5	100
308	M49470X01125MBJ	SM051C125MHJ240	1.2	±20%	5	100
309	M49470X01155KBJ	SM051C155KHJ360	1.5	±10%	5	100
310	M49470X01155MBJ	SM051C155MHJ360	1.5	±20%	5	100
311	M49470X01185KBJ	SM051C185KHJ360	1.8	±10%	5	100
312	M49470X01185MBJ	SM051C185MHJ360	1.8	±20%	5	100
313	M49470X01225KBJ	SM051C225KHJ480	2.2	±10%	5	100
314	M49470X01225MBJ	SM051C225MHJ480	2.2	±20%	5	100
	M49470X01225KBC	SM041C225KHJ240	2.2	±10%	4	100
	M49470X01225MBC	SM041C225MHJ240	2.2	±20%	4	100
315	M49470X01275KBJ	SM051C275KHJ480	2.7	±10%	5	100
316	M49470X01275MBJ	SM051C275MHJ480	2.7	±20%	5	100
317	M49470X01335KBJ	SM051C335KHJ650	3.3	±10%	5	100
318	M49470X01335MBJ	SM051C335MHJ650	3.3	±20%	5	100
	M49470X01335KBC	SM041C335KHJ240	3.3	±10%	4	100
	M49470X01335MBC	SM041C335MHJ240	3.3	±20%	4	100
319	M49470X01395KBJ	SM041C395KHJ360	3.9	±10%	4	100
320	M49470X01395MBJ	SM041C395MHJ360	3.9	±20%	4	100
321	M49470X01475KBJ	SM041C475KHJ360	4.7	±10%	4	100
322	M49470X01475MBJ	SM041C475MHJ360	4.7	±20%	4	100
323	M49470X01565KBJ	SM041C565KHJ480	5.6	±10%	4	100
324	M49470X01565MBJ	SM041C565MHJ480	5.6	±20%	4	100
325	M49470X01685KBJ	SM041C685KHJ480	6.8	±10%	4	100
326	M49470X01685MBJ	SM041C685MHJ480	6.8	±20%	4	100
327	M49470X01825KBJ	SM041C825KHJ650	8.2	±10%	4	100
328	M49470X01825MBJ	SM041C825MHJ650	8.2	±20%	4	100
	M49470X01825KBC	SM031C825KHJ240	8.2	±10%	3	100
	M49470X01825MBC	SM031C825MHJ240	8.2	±20%	3	100
329	M49470X01106KBJ	SM031C106KHJ240	10	±10%	3	100
330	M49470X01106MBJ	SM031C106MHJ240	10	±20%	3	100
331	M49470X01126KBJ	SM031C126KHJ240	12	±10%	3	100
332	M49470X01126MBJ	SM031C126MHJ240	12	±20%	3	100
333	M49470X01156KBJ	SM031C156KHJ360	15	±10%	3	100
334	M49470X01156MBJ	SM031C156MHJ360	15	±20%	3	100
335	M49470X01186KBJ	SM031C186KHJ360	18	±10%	3	100
336	M49470X01186MBJ	SM031C186MHJ360	18	±20%	3	100
337	M49470X01226KBJ	SM031C226KHJ480	22	±10%	3	100
338	M49470X01226MBJ	SM031C226MHJ480	22	±20%	3	100
339	M49470X01276KBJ	SM031C276KHJ650	27	±10%	3	100
340	M49470X01276MBJ	SM031C276MHJ650	27	±20%	3	100
	M49470X01276KBC	SM021C276KHJ240	27	±10%	2	100
	M49470X01276MBC	SM021C276MHJ240	27	±20%	2	100
341	M49470X01336KBJ	SM011C336KHJ360	33	±10%	1	100
342	M49470X01336MBJ	SM011C336MHJ360	33	±20%	1	100
	M49470X01336KBC	SM021C336KHJ240	33	±10%	2	100
	M49470X01336MBC	SM021C336MHJ240	33	±20%	2	100
343	M49470X01396KBJ	SM011C396KHJ480	39	±10%	1	100
344	M49470X01396MBJ	SM011C396MHJ480	39	±20%	1	100

87106-	MIL-PRF-49470 PIN	AVX PART NUMBER	CAP (µF)	TOL	CASE CODE	VOLT (VDC)
	M49470X01396KBC	SM021C396KHJ360	39	±10%	2	100
	M49470X01396MBC	SM021C396MHJ360	39	±20%	2	100
345	M49470X01476KBJ	SM011C476KHJ480	47	±10%	1	100
346	M49470X01476MBJ	SM011C476MHJ480	47	±20%	1	100
	M49470X01476KBC	SM021C476KHJ360	47	±10%	2	100
	M49470X01476MBC	SM021C476MHJ360	47	±20%	2	100
347	M49470X01566KBJ	SM011C566KHJ650	56	±10%	1	100
348	M49470X01566MBJ	SM011C566MHJ650	56	±20%	1	100
349	M49470X01686KBJ	SM021C686KHJ480	68	±10%	2	100
350	M49470X01686MBJ	SM021C686MHJ480	68	±20%	2	100
351	M49470X01826KBJ	SM021C826KHJ650	82	±10%	2	100
352	M49470X01826MBJ	SM021C826MHJ650	82	±20%	2	100
353	M49470X01107KBJ	SM061C107KHJ360	100	±10%	6	100
354	M49470X01107MBJ	SM061C107MHJ360	100	±20%	6	100
355	M49470X01127KBJ	SM061C127KHJ360	120	±10%	6	100
356	M49470X01127MBJ	SM061C127MHJ360	120	±20%	6	100
357	M49470X01157KBJ	SM061C157KHJ480	150	±10%	6	100
358	M49470X01157MBJ	SM061C157MHJ480	150	±20%	6	100
359	M49470X01187KBJ	SM061C187KHJ650	180	±10%	6	100
360	M49470X01187MBJ	SM061C187MHJ650	180	±20%	6	100
361	M49470R01474KCJ	SM052C474KHJ240	0.47	±10%	5	200
362	M49470R01474MCJ	SM052C474MHJ240	0.47	±20%	5	200
363	M49470R01564KCJ	SM052C564KHJ240	0.56	±10%	5	200
364	M49470R01564MCJ	SM052C564MHJ240	0.56	±20%	5	200
365	M49470R01684KCJ	SM052C684KHJ360	0.68	±10%	5	200
366	M49470R01684MCJ	SM052C684MHJ360	0.68	±20%	5	200
367	M49470R01824KCJ	SM052C824KHJ360	0.82	±10%	5	200
368	M49470R01824MCJ	SM052C824MHJ360	0.82	±20%	5	200
369	M49470R01105KCJ	SM052C105KHJ480	1.0	±10%	5	200
370	M49470R01105MCJ	SM052C105MHJ480	1.0	±20%	5	200
	M49470R01105KCC	SM042C105KHJ120	1.0	±10%	4	200
	M49470R01105MCC	SM042C105MHJ120	1.0	±20%	4	200
371	M49470R01125KCJ	SM052C125KHJ480	1.2	±10%	5	200
372	M49470R01125MCJ	SM052C125MHJ480	1.2	±20%	5	200
	M49470R01125KCC	SM042C125KHJ240	1.2	±10%	4	200
	M49470R01125MCC	SM042C125MHJ240	1.2	±20%	4	200
373	M49470R01155KCJ	SM052C155KHJ650	1.5	±10%	5	200
374	M49470R01155MCJ	SM052C155MHJ650	1.5	±20%	5	200
	M49470R01155KCC	SM042C155KHJ230	1.5	±10%	4	200
	M49470R01155MCC	SM042C155MHJ230	1.5	±20%	4	200
375	M49470R01185KCJ	SM042C185KHJ360	1.8	±10%	4	200
376	M49470R01185MCJ	SM042C185MHJ360	1.8	±20%	4	200
377	M49470R01225KCJ	SM042C225KHJ360	2.2	±10%	4	200
378	M49470R01225MCJ	SM042C225MHJ360	2.2	±20%	4	200
379	M49470R01275KCJ	SM042C275KHJ480	2.7	±10%	4	200
380	M49470R01275MCJ	SM042C275MHJ480	2.7	±20%	4	200
381	M49470R01335KCJ	SM042C335KHJ480	3.3	±10%	4	200
382	M49470R01335MCJ	SM042C335MHJ480	3.3	±20%	4	200
383	M49470R01395KCJ	SM042C395KHJ650	3.9	±10%	4	200
384	M49470R01395MCJ	SM042C395MHJ650	3.9	±20%	4	200
	M49470R01395KCC	SM032C395KHJ240	3.9	±10%	3	200
	M49470R01395MCC	SM032C395MHJ240	3.9	±20%	3	200
385	M49470R01475KCJ	SM032C475KHJ240	4.7	±10%	3	200
386	M49470R01475MCJ	SM032C475MHJ240	4.7	±20%	3	200
387	M49470R01565KCJ	SM032C565KHJ240	5.6	±10%	3	200
388	M49470R01565MCJ	SM032C565MHJ240	5.6	±20%	3	200
389	M49470R01685KCJ	SM032C685KHJ360	6.8	±10%	3	200
390	M49470R01685MCJ	SM032C685MHJ360	6.8	±20%	3	200
391	M49470R01825KCJ	SM032C825KHJ360	8.2	±10%	3	200
392	M49470R01825MCJ	SM032C825MHJ360	8.2	±20%	3	200
393	M49470R01106KCJ	SM032C106KHJ480	10	±10%	3	200
394	M49470R01106MCJ	SM032C106MHJ480	10	±20%	3	200



SMPS Stacked MLC Capacitors



(SM Style) SM Military Styles MIL-PRF-49470

87106-	MIL-PRF-49470 PIN	AVX PART NUMBER	CAP (µF)	TOL	CASE CODE	VOLT (VDC)
395	M49470R01126KCJ	SM032C126KHJ650	12	±10%	3	200
396	M49470R01126MCJ	SM032C126MHJ650	12	±20%	3	200
	M49470R01126KCC	SM022C126KHJ240	12	±10%	2	200
	M49470R01126MCC	SM022C126MHJ240	12	±20%	2	200
397	M49470R01156KCJ	SM012C156KHJ360	15	±10%	1	200
398	M49470R01156MCJ	SM012C156MHJ360	15	±20%	1	200
	M49470R01156KCC	SM022C156KHJ240	15	±10%	2	200
	M49470R01156MCC	SM022C156MHJ240	15	±20%	2	200
399	M49470R01186KCJ	SM012C186KHJ480	18	±10%	1	200
400	M49470R01186MCJ	SM012C186MHJ480	18	±20%	1	200
	M49470R01186KCC	SM022C186KHJ360	18	±10%	2	200
	M49470R01186MCC	SM022C186MHJ360	18	±20%	2	200
401	M49470R01226KCJ	SM012C226KHJ650	22	±10%	1	200
402	M49470R01226MCJ	SM012C226MHJ650	22	±20%	1	200
	M49470R01226KCC	SM022C226KHJ360	22	±10%	2	200
	M49470R01226MCC	SM022C226MHJ360	22	±20%	2	200
403	M49470R01276KCJ	SM012C276KHJ650	27	±10%	1	200
404	M49470R01276MCJ	SM012C276MHJ650	27	±20%	1	200
	M49470R01276KCC	SM022C276KHJ480	27	±10%	2	200
	M49470R01276MCC	SM022C276MHJ480	27	±20%	2	200
405	M49470R01336KCJ	SM022C336KHJ480	33	±10%	2	200
406	M49470R01336MCJ	SM022C336MHJ480	33	±20%	2	200
407	M49470R01396KCJ	SM022C396KHJ650	39	±10%	2	200
408	M49470R01396MCJ	SM022C396MHJ650	39	±20%	2	200
409	M49470R01476KCJ	SM062C476KHJ240	47	±10%	6	200
410	M49470R01476MCJ	SM062C476MHJ240	47	±20%	6	200
411	M49470R01566KCJ	SM062C566KHJ360	56	±10%	6	200
412	M49470R01566MCJ	SM062C566MHJ360	56	±20%	6	200
413	M49470R01686KCJ	SM062C686KHJ360	68	±10%	6	200
414	M49470R01686MCJ	SM062C686MHJ360	68	±20%	6	200
415	M49470R01826KCJ	SM062C826KHJ480	82	±10%	6	200
416	M49470R01826MCJ	SM062C826MHJ480	82	±20%	6	200
417	M49470R01107KCJ	SM062C107KHJ650	100	±10%	6	200
418	M49470R01107MCJ	SM062C107MHJ650	100	±20%	6	200
419	M49470R01127KCJ	SM062C127KHJ650	120	±10%	6	200
420	M49470R01127MCJ	SM062C127MHJ650	120	±20%	6	200
421	M49470Q01154KEJ	SM057C154KHJ120	0.15	±10%	5	500
422	M49470Q01154MEJ	SM057C154MHJ120	0.15	±20%	5	500
423	M49470Q01184KEJ	SM057C184KHJ240	0.18	±10%	5	500
424	M49470Q01184MEJ	SM057C184MHJ240	0.18	±20%	5	500
425	M49470Q01224KEJ	SM057C224KHJ240	0.22	±10%	5	500
426	M49470Q01224MEJ	SM057C224MHJ240	0.22	±20%	5	500
427	M49470Q01274KEJ	SM057C274KHJ240	0.27	±10%	5	500
428	M49470Q01274MEJ	SM057C274MHJ240	0.27	±20%	5	500
429	M49470Q01334KEJ	SM057C334KHJ360	0.33	±10%	5	500
430	M49470Q01334MEJ	SM057C334MHJ360	0.33	±20%	5	500
431	M49470Q01394KEJ	SM057C394KHJ360	0.39	±10%	5	500
432	M49470Q01394MEJ	SM057C394MHJ360	0.39	±20%	5	500
433	M49470Q01474KEJ	SM057C474KHJ360	0.47	±10%	5	500
434	M49470Q01474MEJ	SM057C474MHJ360	0.47	±20%	5	500
435	M49470Q01564KEJ	SM057C564KHJ480	0.56	±10%	5	500
436	M49470Q01564MEJ	SM057C564MHJ480	0.56	±20%	5	500
	M49470Q01564KEC	SM047C564KHJ240	0.56	±10%	4	500
	M49470Q01564MEC	SM047C564MHJ240	0.56	±20%	4	500
437	M49470Q01684KEJ	SM057C684KHJ650	0.68	±10%	5	500
438	M49470Q01684MEJ	SM057C684MHJ650	0.68	±20%	5	500
	M49470Q01684KEC	SM047C684KHJ240	0.68	±10%	4	500
	M49470Q01684MEC	SM047C684MHJ240	0.68	±20%	4	500
439	M49470Q01824KEJ	SM047C824KHJ360	0.82	±10%	4	500
440	M49470Q01824MEJ	SM047C824MHJ360	0.82	±20%	4	500
441	M49470Q01105KEJ	SM047C105KHJ360	1.0	±10%	4	500
442	M49470Q01105MEJ	SM047C105MHJ360	1.0	±20%	4	500

87106-	MIL-PRF-49470 PIN	AVX PART NUMBER	CAP (µF)	TOL	CASE CODE	VOLT (VDC)
443	M49470Q01125KEJ	SM047C125KHJ360	1.2	±10%	4	500
444	M49470Q01125MEJ	SM047C125MHJ360	1.2	±20%	4	500
445	M49470Q01155KEJ	SM047C155KHJ480	1.5	±10%	4	500
446	M49470Q01155MEJ	SM047C155MHJ480	1.5	±20%	4	500
447	M49470Q01185KEJ	SM047C185KHJ650	1.8	±10%	4	500
448	M49470Q01185MEJ	SM047C185MHJ650	1.8	±20%	4	500
	M49470Q01185KEC	SM037C185KHJ240	1.8	±10%	3	500
	M49470Q01185MEC	SM037C185MHJ240	1.8	±20%	3	500
449	M49470Q01225KEJ	SM037C225KHJ240	2.2	±10%	3	500
450	M49470Q01225MEJ	SM037C225MHJ240	2.2	±20%	3	500
451	M49470Q01275KEJ	SM037C275KHJ360	2.7	±10%	3	500
452	M49470Q01275MEJ	SM037C275MHJ360	2.7	±20%	3	500
453	M49470Q01335KEJ	SM037C335KHJ360	3.3	±10%	3	500
454	M49470Q01335MEJ	SM037C335MHJ360	3.3	±20%	3	500
455	M49470Q01395KEJ	SM037C395KHJ360	3.9	±10%	3	500
456	M49470Q01395MEJ	SM037C395MHJ360	3.9	±20%	3	500
457	M49470Q01475KEJ	SM037C475KHJ480	4.7	±10%	3	500
458	M49470Q01475MEJ	SM037C475MHJ480	4.7	±20%	3	500
459	M49470Q01565KEJ	SM037C565KHJ650	5.6	±10%	3	500
460	M49470Q01565MEJ	SM037C565MHJ650	5.6	±20%	3	500
	M49470Q01565KEC	SM027C565KHJ240	5.6	±10%	2	500
	M49470Q01565MEC	SM027C565MHJ240	5.6	±20%	2	500
461	M49470Q01685KEJ	SM017C685KHJ480	6.8	±10%	1	500
462	M49470Q01685MEJ	SM017C685MHJ480	6.8	±20%	1	500
	M49470Q01685KEC	SM027C685KHJ240	6.8	±10%	2	500
	M49470Q01685MEC	SM027C685MHJ240	6.8	±20%	2	500
463	M49470Q01825KEJ	SM017C825KHJ480	8.2	±10%	1	500
464	M49470Q01825MEJ	SM017C825MHJ480	8.2	±20%	1	500
	M49470Q01825KEC	SM027C825KHJ360	8.2	±10%	2	500
	M49470Q01825MEC	SM027C825MHJ360	8.2	±20%	2	500
465	M49470Q01106KEJ	SM017C106KHJ480	10	±10%	1	500
466	M49470Q01106MEJ	SM017C106MHJ480	10	±20%	1	500
	M49470Q01106KEC	SM027C106KHJ360	10	±10%	2	500
	M49470Q01106MEC	SM027C106MHJ360	10	±20%	2	500
467	M49470Q01126KEJ	SM017C126KHJ650	12	±10%	1	500
468	M49470Q01126MEJ	SM017C126MHJ650	12	±20%	1	500
	M49470Q01126MEC	SM027C126MHJ480	12	±20%	2	500
	M49470Q01126MEC	SM027C126MHJ480	12	±20%	2	500
469	M49470Q01156KEJ	SM027C156KHJ650	15	±10%	2	500
470	M49470Q01156MEJ	SM027C156MHJ650	15	±20%	2	500
471	M49470Q01186KEJ	SM027C186KHJ650	18	±10%	2	500
472	M49470Q01186MEJ	SM027C186MHJ650	18	±20%	2	500
473	M49470Q01226KEJ	SM067C226KHJ360	22	±10%	6	500
474	M49470Q01226MEJ	SM067C226MHJ360	22	±20%	6	500
475	M49470Q01276KEJ	SM067C276KHJ360	27	±10%	6	500
476	M49470Q01276MEJ	SM067C276MHJ360	27	±20%	6	500
477	M49470Q01336KEJ	SM067C336KHJ480	33	±10%	6	500
478	M49470Q01336MEJ	SM067C336MHJ480	33	±20%	6	500
479	M49470Q01396KEJ	SM067C396KHJ650	39	±10%	6	500
480	M49470Q01396MEJ	SM067C396MHJ650	39	±20%	6	500

SMPS Stacked MLC Capacitors



(SM Style) SM Military Styles DSCC Dwg. #87106 & #88011

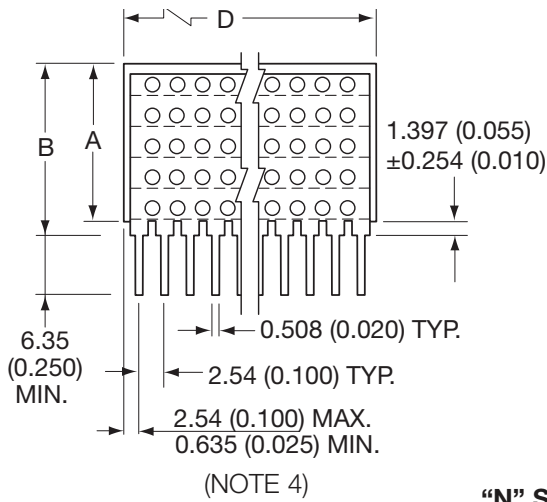

“N” STYLE LEADS

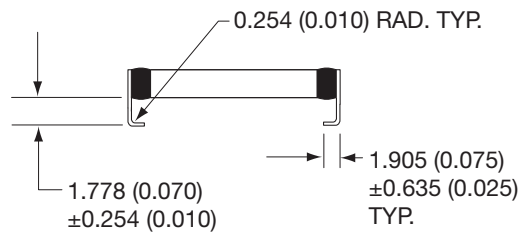
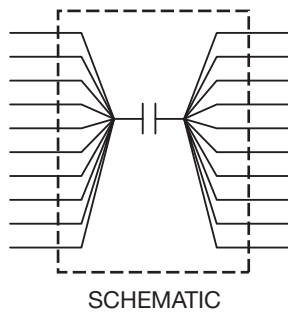
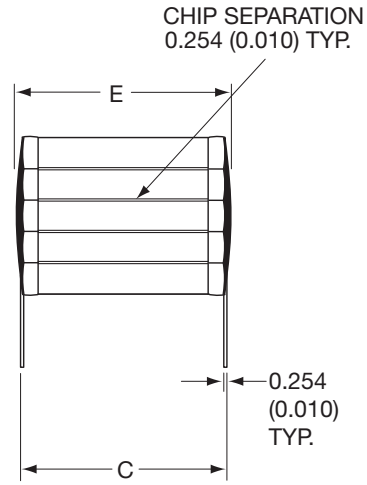

“J” STYLE LEADS

DIMENSIONS

millimeters (inches)

Case Code	A (max.) (See Note 2)	B (max.) (See Note 2)	C ±.635 (±0.025)	D ±.635 (±0.025)	E (max.)	No. of Leads per side
1	16.5 (0.650)	18.2 (0.715)	11.4 (0.450)	52.1 (2.050)	12.7 (0.500)	20
2	16.5 (0.650)	18.2 (0.715)	20.3 (0.800)	38.4 (1.510)	22.1 (0.870)	15
3	16.5 (0.650)	18.2 (0.715)	11.4 (0.450)	26.7 (1.050)	12.7 (0.500)	10
4	16.5 (0.650)	18.2 (0.715)	10.2 (0.400)	10.2 (0.400)	11.2 (0.440)	4
5	16.5 (0.650)	18.2 (0.715)	6.35 (0.250)	6.35 (0.250)	7.62 (0.300)	3
6	16.5 (0.650)	18.2 (0.715)	31.8 (1.250)	52.1 (2.050)	34.3 (1.350)	20

NOTES:

1. Unless otherwise specified, tolerances 0.254 (±0.010).
2. “A” dimensions are maximum (see tables on pages 22 thru 25 for specific part number dimensions).
3. “N” straight leads; “J” leads formed in.
4. For case code 5, dimensions shall be 2.54 (0.100) maximum, 0.305 (0.012) minimum.



SMPS Stacked MLC Capacitors



(SM Style) SM Military Styles DSCC Dwg. #87106 & #88011

Ordering Information

Part Number: The complete part number shall be as follows:

X7R: 87106 XXX

_____ Drawing number

_____ Dash number
(see list)

Ordering Data. The contract or purchase order should specify the following:

- a. Complete part number.
- b. Requirements for delivery of one copy of the quality conformance inspection data with each shipment of parts by the manufacturer.
- c. Whether the manufacturer performs the group B tests, or provides certification of compliance with group B requirements.
- d. Requirements for notification of change of products to acquiring activity, if applicable.
- e. Requirements for packaging and packing.

Source of Supply.

Vendor CAGE
number

Vendor name
and address

96095

Olean Advanced Products
A Division of AVX Corporation
1695 Seneca Avenue
Olean, NY 14760

Performance Characteristics

Operating Temperature Range. The operating temperature range shall be -55°C to +125°C.

Electrical Characteristics.

Rated Voltage. See tables on pages 22, 23, 24 & 25.

Capacitance. Measured in accordance with method 305 of MIL-STD-202 (1KHz at 1.0Vrms, open circuit voltage, at +25°C).

Dissipation Factor (+25°C). X7R: Dissipation factor shall be 2.5 percent maximum (measured under the same conditions as capacitance.) C0G: Dissipation factor shall be 0.15 percent maximum.

Temperature Coefficient.

DSCC Dwg.	Bias = 0 volt	Bias = rated voltage
88011 All Voltages	0±30 ppm/°C	0±30 ppm/°C
87106 50 WVDC and 100 WVDC	±15%	+15, -25%
87106 200 WVDC	±15%	+15, -40%
87106 500 WVDC	±15%	+15, -50%

Insulation Resistance.

At +25°C, rated voltage: 100K MΩ or 1,000 MΩ-μF, whichever is less.

At +125°C, rated voltage: 10K MΩ or 100 MΩ-μF, whichever is less.

Dielectric Withstanding Voltage. Dielectric withstanding voltage shall be 250 percent of rated voltage except 500V rated parts at 150 percent of rated voltage.

Capacitance Tolerance. J = ±5 percent, K = ±10 percent, M = ±20 percent.

Solderability of Terminals. In accordance with MIL-PRF-49470.

Resistance to Soldering Heat. In accordance with MIL-STD-202, method 210, condition B, for 20 seconds.

Shock. In accordance with MIL-PRF-49470.

Immersion Cycling. In accordance with MIL-PRF-49470.

Moisture Resistance. In accordance with MIL-PRF-49470.

Life. Life shall be 200 percent of rated voltage except 500V rated parts at 120 percent of rated voltage applied at +125°C for 1,000 hours.

Thermal Shock. MIL-STD-202, method 107, test condition A, except high temperature is +125°C.

Voltage Conditioning. In accordance with MIL-PRF-49470, except 500V rated parts at 120 percent of rated voltage at +125°C.

Terminal Strength. MIL-STD-202, method 211, condition B, except that each lead shall be bent away from the body 90 degrees from the original position and back, two bends.

Marking. Marking shall be in accordance with MIL-STD-1285, except the part number shall be as specified in paragraph 1.2 of 87106, or 88011 with the manufacturer's name or code and date code minimum, except case sizes 4 and 5 shall be marked with coded cap and tolerance minimum. Full marking shall be included on the package.



SMPS Stacked MLC Capacitors



(SM Style) DSCC #87106 and #88011

Table II. Group A inspection.

Inspection	Requirement paragraph of MIL-PRF-49470	Test method paragraph of MIL-PRF-49470	Sampling procedure
Subgroup 1 Thermal shock and voltage conditioning <u>1/</u>	3.9	4.8.5	100% inspection
Subgroup 2 Visual and mechanical examination: Material Physical dimensions Interface requirements (other than physical dimensions) Marking <u>2/</u> Workmanship	3.4 3.1 3.5 and 3.5.1 3.28 3.30	4.8.4	13 samples 0 failures

1/ Post checks are required (see paragraph 3.9 of MIL-PRF-49470).

2/ Marking defects are based on visual examination only. Any subsequent electrical defects shall not be used as a basis for determining marking defects.

Table III. Group B inspection. 1/

Inspection	Requirement paragraph of MIL-PRF-49470	Test method paragraph of MIL-PRF-49470	Number of sample units to be inspected	Number of defectives permitted <u>2/</u>	
Subgroup 1 <u>3/</u> Temperature coefficient Resistance to solvents <u>5/</u> <u>6/</u> Immersion Terminal strength <u>5/</u>	<u>4/</u> 3.23 3.18 3.24	<u>4/</u> 4.8.20 4.8.15 4.8.10	12	1	<u>6/</u> 1
Subgroup 2 Resistance to soldering heat Moisture resistance	3.20 3.21	4.8.17 4.8.18	12	1	
Subgroup 3 Marking legibility (laser marking only)	3.28.1	4.8.4.1	6	1	
Subgroup 4 Solderability	3.15	4.8.12	3	0	
Subgroup 5 Life	3.26	4.8.22	5 minimum per case code	0	

1/ Unless otherwise specified herein, when necessary, mounting of group B samples shall be at the discretion of the manufacturer.

2/ A sample unit having one or more defects shall be charged as a single defective.

3/ Order of tests is at discretion of manufacturer.

4/ See 3.2.3 of DSCC 87106.

5/ Sample size shall be 3 pieces with zero defectives permitted.

6/ Total of one defect allowed for combination of subgroup 1, subgroup 2, and subgroup 3 inspections.

SMPS Stacked MLC Capacitors



(SM Style) SM Military Styles DSCC Dwg. #87106 (X7R)

Electrical characteristics

DSCC Dwg. 87106-	Cap. Value (µF)	Cap. Tol.	Case Code	Lead Style	Max. A Dimension mm (inches)
50V					
001	1.0	K	5	N	3.05 (0.120)
002	1.0	M	5	N	3.05 (0.120)
241	1.0	K	5	J	3.05 (0.120)
242	1.0	M	5	J	3.05 (0.120)
003	1.2	K	5	N	3.05 (0.120)
004	1.2	M	5	N	3.05 (0.120)
243	1.2	K	5	J	3.05 (0.120)
244	1.2	M	5	J	3.05 (0.120)
005	1.5	K	5	N	6.10 (0.240)
006	1.5	M	5	N	6.10 (0.240)
245	1.5	K	5	J	6.10 (0.240)
246	1.5	M	5	J	6.10 (0.240)
007	1.8	K	5	N	6.10 (0.240)
008	1.8	M	5	N	6.10 (0.240)
247	1.8	K	5	J	6.10 (0.240)
248	1.8	M	5	J	6.10 (0.240)
009	2.2	K	5	N	6.10 (0.240)
010	2.2	M	5	N	6.10 (0.240)
249	2.2	K	5	J	6.10 (0.240)
250	2.2	M	5	J	6.10 (0.240)
011	2.7	K	5	N	9.14 (0.360)
012	2.7	M	5	N	9.14 (0.360)
251	2.7	K	5	J	9.14 (0.360)
252	2.7	M	5	J	9.14 (0.360)
013	3.3	K	5	N	9.14 (0.360)
014	3.3	M	5	N	9.14 (0.360)
253	3.3	K	5	J	9.14 (0.360)
254	3.3	M	5	J	9.14 (0.360)
015	3.9	K	5	N	12.2 (0.480)
016	3.9	M	5	N	12.2 (0.480)
255	3.9	K	5	J	12.2 (0.480)
256	3.9	M	5	J	12.2 (0.480)
017	4.7	K	5	N	12.2 (0.480)
018	4.7	M	5	N	12.2 (0.480)
257	4.7	K	5	J	12.2 (0.480)
258	4.7	M	5	J	12.2 (0.480)
019	5.6	K	5	N	16.5 (0.650)
020	5.6	M	5	N	16.5 (0.650)
259	5.6	K	5	J	16.5 (0.650)
260	5.6	M	5	J	16.5 (0.650)
223	6.8	K	4	N	9.14 (0.360)
224	6.8	M	4	N	9.14 (0.360)
261	6.8	K	4	J	9.14 (0.360)
262	6.8	M	4	J	9.14 (0.360)
021	8.2	K	4	N	9.14 (0.360)
022	8.2	M	4	N	9.14 (0.360)
263	8.2	K	4	J	9.14 (0.360)
264	8.2	M	4	J	9.14 (0.360)
023	10	K	4	N	12.2 (0.480)
024	10	M	4	N	12.2 (0.480)
265	10	K	4	J	12.2 (0.480)
266	10	M	4	J	12.2 (0.480)
025	12	K	4	N	12.2 (0.480)
026	12	M	4	N	12.2 (0.480)
267	12	K	4	J	12.2 (0.480)
268	12	M	4	J	12.2 (0.480)
027	15	K	4	N	16.5 (0.650)
028	15	M	4	N	16.5 (0.650)
269	15	K	4	J	16.5 (0.650)
270	15	M	4	J	16.5 (0.650)
029	18	K	3	N	6.10 (0.240)
030	18	M	3	N	6.10 (0.240)
271	18	K	3	J	6.10 (0.240)

DSCC Dwg. 87106-	Cap. Value (µF)	Cap. Tol.	Case Code	Lead Style	Max. A Dimension mm (inches)
50V					
272	18	M	3	J	6.10 (0.240)
272	18	M	3	J	6.10 (0.240)
031	22	K	3	N	9.14 (0.360)
032	22	M	3	N	9.14 (0.360)
273	22	K	3	J	9.14 (0.360)
274	22	M	3	J	9.14 (0.360)
033	27	K	3	N	9.14 (0.360)
034	27	M	3	N	9.14 (0.360)
275	27	K	3	J	9.14 (0.360)
276	27	M	3	J	9.14 (0.360)
035	33	K	3	N	9.14 (0.360)
036	33	M	3	N	9.14 (0.360)
277	33	K	3	J	9.14 (0.360)
278	33	M	3	J	9.14 (0.360)
037	39	K	3	N	12.2 (0.480)
038	39	M	3	N	12.2 (0.480)
279	39	K	3	J	12.2 (0.480)
280	39	M	3	J	12.2 (0.480)
039	47	K	3	N	16.5 (0.650)
040	47	M	3	N	16.5 (0.650)
281	47	K	3	J	16.5 (0.650)
282	47	M	3	J	16.5 (0.650)
225	56	K	1	N	9.14 (0.360)
226	56	M	1	N	9.14 (0.360)
283	56	K	1	J	9.14 (0.360)
284	56	M	1	J	9.14 (0.360)
041	68	K	1	N	12.2 (0.480)
042	68	M	1	N	12.2 (0.480)
285	68	K	1	J	12.2 (0.480)
286	68	M	1	J	12.2 (0.480)
043	82	K	1	N	12.2 (0.480)
044	82	M	1	N	12.2 (0.480)
287	82	K	1	J	12.2 (0.480)
288	82	M	1	J	12.2 (0.480)
045	100	K	1	N	16.5 (0.650)
046	100	M	1	N	16.5 (0.650)
289	100	K	1	J	16.5 (0.650)
290	100	M	1	J	16.5 (0.650)
227	120	K	2	N	12.2 (0.480)
228	120	M	2	N	12.2 (0.480)
291	120	K	2	J	12.2 (0.480)
292	120	M	2	J	12.2 (0.480)
047	150	K	2	N	16.5 (0.650)
048	150	M	2	N	16.5 (0.650)
293	150	K	2	J	16.5 (0.650)
294	150	M	2	J	16.5 (0.650)
049	180	K	6	N	12.2 (0.480)
050	180	M	6	N	12.2 (0.480)
295	180	K	6	J	12.2 (0.480)
296	180	M	6	J	12.2 (0.480)
051	220	K	6	N	12.2 (0.480)
052	220	M	6	N	12.2 (0.480)
297	220	K	6	J	12.2 (0.480)
298	220	M	6	J	12.2 (0.480)
053	270	K	6	N	16.5 (0.650)
054	270	M	6	N	16.5 (0.650)
299	270	K	6	J	16.5 (0.650)
300	270	M	6	J	16.5 (0.650)

DSCC Dwg. 87106-	Cap. Value (µF)	Cap. Tol.	Case Code	Lead Style	Max. A Dimension mm (inches)
100V					
055	.68	K	5	N	3.05 (0.120)
056	.68	M	5	N	3.05 (0.120)
301	.68	K	5	J	3.05 (0.120)
302	.68	M	5	J	3.05 (0.120)
057	.82	K	5	N	6.10 (0.240)
058	.82	M	5	N	6.10 (0.240)
303	.82	K	5	J	6.10 (0.240)
304	.82	M	5	J	6.10 (0.240)
059	1.0	K	5	N	6.10 (0.240)
060	1.0	M	5	N	6.10 (0.240)
305	1.0	K	5	J	6.10 (0.240)
306	1.0	M	5	J	6.10 (0.240)
061	1.2	K	5	N	6.10 (0.240)
062	1.2	M	5	N	6.10 (0.240)
307	1.2	K	5	J	6.10 (0.240)
308	1.2	M	5	J	6.10 (0.240)
063	1.5	K	5	N	9.14 (0.360)
064	1.5	M	5	N	9.14 (0.360)
309	1.5	K	5	J	9.14 (0.360)
310	1.5	M	5	J	9.14 (0.360)
065	1.8	K	5	N	9.14 (0.360)
066	1.8	M	5	N	9.14 (0.360)
311	1.8	K	5	J	9.14 (0.360)
312	1.8	M	5	J	9.14 (0.360)
067	2.2	K	5	N	12.2 (0.480)
068	2.2	M	5	N	12.2 (0.480)
313	2.2	K	5	J	12.2 (0.480)
314	2.2	M	5	J	12.2 (0.480)
069	2.7	K	5	N	12.2 (0.480)
070	2.7	M	5	N	12.2 (0.480)
315	2.7	K	5	J	12.2 (0.480)
316	2.7	M	5	J	12.2 (0.480)
071	3.3	K	5	N	16.5 (0.650)
072	3.3	M	5	N	16.5 (0.650)
317	3.3	K	5	J	16.5 (0.650)
318	3.3	M	5	J	16.5 (0.650)
073	3.9	K	4	N	9.14 (0.360)
074	3.9	M	4	N	9.14 (0.360)
319	3.9	K	4	J	9.14 (0.360)
320	3.9	M	4	J	9.14 (0.360)
075	4.7	K	4	N	9.14 (0.360)
076	4.7	M	4	N	9.14 (0.360)
321	4.7	K	4	J	9.14 (0.360)
322	4.7	M	4	J	9.14 (0.360)
077	5.6	K	4	N	12.2 (0.480)
078	5.6	M	4	N	12.2 (0.480)
323	5.6	K	4	J	12.2 (0.480)
324	5.6	M	4	J	12.2 (0.480)
079	6.8	K	4	N	12.2 (0.480)
080	6.8	M	4	N	12.2 (0.480)
325	6.8	K	4	J	12.2 (0.480)
326	6.8	M	4	J	12.2 (0.480)
081	8.2	K	4	N	16.5 (0.650)
082	8.2	M	4	N	16.5 (0.650)
327	8.2	K	4	J	16.5 (0.650)
328	8.2	M	4	J	16.5 (0.650)
229	10	K	3	N	6.10 (0.240)
230	10	M	3	N	6.10 (0.240)
329	10	K	3	J	6.10 (0.240)
330	10	M	3	J	6.10 (0.240)
083	12	K	3	N	6.10 (0.240)
084	12	M	3	N	6.10 (0.240)
331	12	K	3	J	6.10 (0.240)
332	12	M	3	J	6.10 (0.240)



SMPS Stacked MLC Capacitors



(SM Style) SM Military Styles DSCC Dwg. #87106 (X7R)

Electrical characteristics

DSCC Dwg. 87106-	Cap. Value (µF)	Cap. Tol.	Case Code	Lead Style	Max. A Dimension mm (inches)
100V					
085	15	K	3	N	9.14 (0.360)
086	15	M	3	N	9.14 (0.360)
333	15	K	3	J	9.14 (0.360)
334	15	M	3	J	9.14 (0.360)
087	18	K	3	N	9.14 (0.360)
088	18	M	3	N	9.14 (0.360)
335	18	K	3	J	9.14 (0.360)
336	18	M	3	J	9.14 (0.360)
089	22	K	3	N	12.2 (0.480)
090	22	M	3	N	12.2 (0.480)
337	22	M	3	K	12.2 (0.480)
338	22	M	3	J	12.2 (0.480)
091	27	K	3	N	16.5 (0.650)
092	27	M	3	N	16.5 (0.650)
339	27	K	3	J	16.5 (0.650)
340	27	M	3	J	16.5 (0.650)
093	33	K	1	N	9.14 (0.360)
094	33	M	1	N	9.14 (0.360)
341	33	K	1	J	9.14 (0.360)
342	33	M	1	J	9.14 (0.360)
095	39	K	1	N	12.2 (0.480)
096	39	M	1	N	12.2 (0.480)
343	39	K	1	J	12.2 (0.480)
344	39	M	1	J	12.2 (0.480)
097	47	K	1	N	12.2 (0.480)
098	47	M	1	N	12.2 (0.480)
345	47	K	1	J	12.2 (0.480)
346	47	M	1	J	12.2 (0.480)
099	56	K	1	N	16.5 (0.650)
100	56	M	1	N	16.5 (0.650)
347	56	K	1	J	16.5 (0.650)
348	56	M	1	J	16.5 (0.650)
101	68	K	2	N	12.2 (0.480)
102	68	M	2	N	12.2 (0.480)
349	68	K	2	J	12.2 (0.480)
350	68	M	2	J	12.2 (0.480)
103	82	K	2	N	16.5 (0.650)
104	82	M	2	N	16.5 (0.650)
351	82	K	2	J	16.5 (0.650)
352	82	M	2	J	16.5 (0.650)
105	100	K	6	N	9.14 (0.360)
106	100	M	6	N	9.14 (0.360)
353	100	K	6	J	9.14 (0.360)
354	100	M	6	J	9.14 (0.360)
107	120	K	6	N	9.14 (0.360)
108	120	M	6	N	9.14 (0.360)
355	120	K	6	J	9.14 (0.360)
356	120	M	6	J	9.14 (0.360)
109	150	K	6	N	12.2 (0.480)
110	150	M	6	N	12.2 (0.480)
357	150	K	6	J	12.2 (0.480)
358	150	M	6	J	12.2 (0.480)
111	180	K	6	N	16.5 (0.650)
112	180	M	6	N	16.5 (0.650)
359	180	K	6	J	16.5 (0.650)
360	180	M	6	J	16.5 (0.650)

DSCC Dwg. 87106-	Cap. Value (µF)	Cap. Tol.	Case Code	Lead Style	Max. A Dimension mm (inches)
200V					
113	.47	K	5	N	6.10 (0.240)
114	.47	M	5	N	6.10 (0.240)
361	.47	K	5	J	6.10 (0.240)
362	.47	M	5	J	6.10 (0.240)
115	.56	K	5	N	6.10 (0.240)
116	.56	M	5	N	6.10 (0.240)
363	.56	K	5	J	6.10 (0.240)
364	.56	M	5	J	6.10 (0.240)
117	.68	K	5	N	9.14 (0.360)
118	.68	M	5	N	9.14 (0.360)
365	.68	K	5	J	9.14 (0.360)
366	.68	M	5	J	9.14 (0.360)
119	.82	K	5	N	9.14 (0.360)
120	.82	M	5	N	9.14 (0.360)
367	.82	M	5	J	9.14 (0.360)
368	.82	M	5	J	9.14 (0.360)
121	1.0	K	5	N	12.2 (0.480)
122	1.0	M	5	N	12.2 (0.480)
369	1.0	K	5	J	12.2 (0.480)
370	1.0	M	5	J	12.2 (0.480)
123	1.2	K	5	N	12.2 (0.480)
124	1.2	M	5	N	12.2 (0.480)
371	1.2	K	5	J	12.2 (0.480)
372	1.2	M	5	J	12.2 (0.480)
125	1.5	K	5	N	16.5 (0.650)
126	1.5	M	5	N	16.5 (0.650)
373	1.5	K	5	J	16.5 (0.650)
374	1.5	M	5	J	16.5 (0.650)
127	1.8	K	4	N	9.14 (0.360)
128	1.8	M	4	N	9.14 (0.360)
375	1.8	K	4	J	9.14 (0.360)
376	1.8	M	4	J	9.14 (0.360)
129	2.2	K	4	N	9.14 (0.360)
130	2.2	M	4	N	9.14 (0.360)
377	2.2	K	4	J	9.14 (0.360)
378	2.2	M	4	J	9.14 (0.360)
131	2.7	K	4	N	12.2 (0.480)
132	2.7	M	4	N	12.2 (0.480)
379	2.7	K	4	J	12.2 (0.480)
380	2.7	M	4	J	12.2 (0.480)
133	3.3	K	4	N	12.2 (0.480)
134	3.3	M	4	N	12.2 (0.480)
381	3.3	K	4	J	12.2 (0.480)
382	3.3	M	4	J	12.2 (0.480)
135	3.9	K	4	N	16.5 (0.650)
136	3.9	M	4	N	16.5 (0.650)
383	3.9	K	4	J	16.5 (0.650)
384	3.9	M	4	J	16.5 (0.650)
137	4.7	K	3	N	6.10 (0.240)
138	4.7	M	3	N	6.10 (0.240)
385	4.7	K	3	J	6.10 (0.240)
386	4.7	M	3	J	6.10 (0.240)
139	5.6	K	3	N	6.10 (0.240)
140	5.6	M	3	N	6.10 (0.240)
387	5.6	K	3	J	6.10 (0.240)
388	5.6	M	3	J	6.10 (0.240)
141	6.8	K	3	N	9.14 (0.360)
142	6.8	M	3	N	9.14 (0.360)
389	6.8	K	3	J	9.14 (0.360)
390	6.8	M	3	J	9.14 (0.360)
143	8.2	K	3	N	9.14 (0.360)
144	8.2	M	3	N	9.14 (0.360)
391	8.2	K	3	J	9.14 (0.360)
392	8.2	M	3	J	9.14 (0.360)

DSCC Dwg. 87106-	Cap. Value (µF)	Cap. Tol.	Case Code	Lead Style	Max. A Dimension mm (inches)
200V					
145	10	K	3	N	12.2 (0.480)
146	10	M	3	N	12.2 (0.480)
393	10	K	3	J	12.2 (0.480)
394	10	M	3	J	12.2 (0.480)
147	12	K	3	N	16.5 (0.650)
148	12	M	3	N	16.5 (0.650)
395	12	K	3	J	16.5 (0.650)
396	12	M	3	J	16.5 (0.650)
149	15	K	1	N	9.14 (0.360)
150	15	M	1	N	9.14 (0.360)
397	15	K	1	J	9.14 (0.360)
398	15	M	1	J	9.14 (0.360)
151	18	K	1	N	12.2 (0.480)
152	18	M	1	N	12.2 (0.480)
399	18	K	1	J	12.2 (0.480)
400	18	M	1	J	12.2 (0.480)
153	22	K	1	N	16.5 (0.650)
154	22	M	1	N	16.5 (0.650)
401	22	K	1	J	16.5 (0.650)
402	22	M	1	J	16.5 (0.650)
155	27	K	1	N	16.5 (0.650)
156	27	M	1	N	16.5 (0.650)
403	27	K	1	J	16.5 (0.650)
404	27	M	1	J	16.5 (0.650)
157	33	K	2	N	12.2 (0.480)
158	33	M	2	N	12.2 (0.480)
405	33	K	2	J	12.2 (0.480)
406	33	M	2	J	12.2 (0.480)
159	39	K	2	N	16.5 (0.650)
160	39	M	2	N	16.5 (0.650)
407	39	K	2	J	16.5 (0.650)
408	39	M	2	J	16.5 (0.650)
161	47	K	6	N	6.10 (0.240)
162	47	M	6	N	6.10 (0.240)
409	47	K	6	J	6.10 (0.240)
410	47	M	6	J	6.10 (0.240)
163	56	K	6	N	9.14 (0.360)
164	56	M	6	N	9.14 (0.360)
411	56	K	6	J	9.14 (0.360)
412	56	M	6	J	9.14 (0.360)
165	68	K	6	N	9.14 (0.360)
166	68	M	6	N	9.14 (0.360)
413	68	K	6	J	9.14 (0.360)
414	68	M	6	J	9.14 (0.360)
167	82	K	6	N	12.2 (0.480)
168	82	M	6	N	12.2 (0.480)
415	82	K	6	J	12.2 (0.480)
416	82	M	6	J	12.2 (0.480)
169	100	K	6	N	16.5 (0.650)
170	100	M	6	N	16.5 (0.650)
417	100	K	6	J	16.5 (0.650)
418	100	M	6	J	16.5 (0.650)
171	120	K	6	N	16.5 (0.650)
172	120	M	6	N	16.5 (0.650)
419	120	K	6	J	16.5 (0.650)
420	120	M	6	J	16.5 (0.650)



SMPS Stacked MLC Capacitors



(SM Style) SM Military Styles DSCC Dwg. #87106 (X7R)

Electrical characteristics

DSCC Dwg. 87106-	Cap. Value (µF)	Cap. Tol.	Case Code	Lead Style	Max. A Dimension mm (inches)
500V					
173	.15	K	5	N	3.05 (0.120)
174	.15	M	5	N	3.05 (0.120)
421	.15	K	5	J	3.05 (0.120)
422	.15	M	5	J	3.05 (0.120)
175	.18	K	5	N	6.10 (0.240)
176	.18	M	5	N	6.10 (0.240)
423	.18	K	5	J	6.10 (0.240)
424	.18	M	5	J	6.10 (0.240)
177	.22	K	5	N	6.10 (0.240)
178	.22	M	5	N	6.10 (0.240)
425	.22	K	5	J	6.10 (0.240)
426	.22	M	5	J	6.10 (0.240)
179	.27	K	5	N	6.10 (0.240)
180	.27	M	5	N	6.10 (0.240)
427	.27	K	5	J	6.10 (0.240)
428	.27	M	5	J	6.10 (0.240)
181	.33	K	5	N	9.14 (0.360)
182	.33	M	5	N	9.14 (0.360)
429	.33	K	5	J	9.14 (0.360)
430	.33	M	5	J	9.14 (0.360)
183	.39	K	5	N	9.14 (0.360)
184	.39	M	5	N	9.14 (0.360)
431	.39	K	5	J	9.14 (0.360)
432	.39	M	5	J	9.14 (0.360)
185	.47	K	5	N	9.14 (0.360)
186	.47	M	5	N	9.14 (0.360)
433	.47	K	5	J	9.14 (0.360)
434	.47	M	5	J	9.14 (0.360)
187	.56	K	5	N	12.2 (0.480)
188	.56	M	5	N	12.2 (0.480)
435	.56	K	5	J	12.2 (0.480)
436	.56	M	5	J	12.2 (0.480)
189	.68	K	5	N	16.5 (0.650)
190	.68	M	5	N	16.5 (0.650)
437	.68	K	5	J	16.5 (0.650)
438	.68	M	5	J	16.5 (0.650)
231	.82	K	4	N	9.14 (0.360)
232	.82	M	4	N	9.14 (0.360)
439	.82	K	4	J	9.14 (0.360)
440	.82	M	4	J	9.14 (0.360)
191	1.0	K	4	N	9.14 (0.360)
192	1.0	M	4	N	9.14 (0.360)
441	1.0	K	4	J	9.14 (0.360)
442	1.0	M	4	J	9.14 (0.360)
193	1.2	K	4	N	9.14 (0.360)
194	1.2	M	4	N	9.14 (0.360)
443	1.2	K	4	J	9.14 (0.360)
444	1.2	M	4	J	9.14 (0.360)
195	1.5	K	4	N	12.2 (0.480)
196	1.5	M	4	N	12.2 (0.480)
445	1.5	K	4	J	12.2 (0.480)
446	1.5	M	4	J	12.2 (0.480)
197	1.8	K	4	N	16.5 (0.650)
198	1.8	M	4	N	16.5 (0.650)
447	1.8	K	4	J	16.5 (0.650)
448	1.8	M	4	J	16.5 (0.650)
233	2.2	K	3	N	6.10 (0.240)
234	2.2	M	3	N	6.10 (0.240)
449	2.2	K	3	J	6.10 (0.240)
450	2.2	M	3	J	6.10 (0.240)
199	2.7	K	3	N	9.14 (0.360)
200	2.7	M	3	N	9.14 (0.360)
451	2.7	K	3	J	9.14 (0.360)
452	2.7	M	3	J	9.14 (0.360)

DSCC Dwg. 87106-	Cap. Value (µF)	Cap. Tol.	Case Code	Lead Style	Max. A Dimension mm (inches)
500V					
201	3.3	K	3	N	9.14 (0.360)
202	3.3	M	3	N	9.14 (0.360)
453	3.3	K	3	J	9.14 (0.360)
454	3.3	M	3	J	9.14 (0.360)
203	3.9	K	3	N	9.14 (0.360)
204	3.9	M	3	N	9.14 (0.360)
455	3.9	K	3	J	9.14 (0.360)
456	3.9	M	3	J	9.14 (0.360)
205	4.7	K	3	N	12.2 (0.480)
206	4.7	M	3	N	12.2 (0.480)
457	4.7	K	3	J	12.2 (0.480)
458	4.7	M	3	J	12.2 (0.480)
207	5.6	K	3	N	16.5 (0.650)
208	5.6	M	3	N	16.5 (0.650)
459	5.6	K	3	J	16.5 (0.650)
460	5.6	M	3	J	16.5 (0.650)
235	6.8	K	1	N	12.2 (0.480)
236	6.8	M	1	N	12.2 (0.480)
461	6.8	K	1	J	12.2 (0.480)
462	6.8	M	1	J	12.2 (0.480)
209	8.2	K	1	N	12.2 (0.480)
210	8.2	M	1	N	12.2 (0.480)
463	8.2	K	1	J	12.2 (0.480)
464	8.2	M	1	J	12.2 (0.480)
211	10	K	1	N	12.2 (0.480)
212	10	M	1	N	12.2 (0.480)
465	10	K	1	J	12.2 (0.480)
466	10	M	1	J	12.2 (0.480)
213	12	K	1	N	16.5 (0.650)
214	12	M	1	N	16.5 (0.650)
467	12	K	1	J	16.5 (0.650)
468	12	M	1	J	16.5 (0.650)
237	15	K	2	N	16.5 (0.650)
238	15	M	2	N	16.5 (0.650)
469	15	K	2	J	16.5 (0.650)
470	15	M	2	J	16.5 (0.650)
215	18	K	2	N	16.5 (0.650)
216	18	M	2	N	16.5 (0.650)
471	18	K	2	J	16.5 (0.650)
472	18	M	2	J	16.5 (0.650)
239	22	K	6	N	9.14 (0.360)
240	22	M	6	N	9.14 (0.360)
473	22	K	6	J	9.14 (0.360)
474	22	M	6	J	9.14 (0.360)
217	27	K	6	N	9.14 (0.360)
218	27	M	6	N	9.14 (0.360)
475	27	K	6	J	9.14 (0.360)
476	27	M	6	J	9.14 (0.360)
219	33	K	6	N	12.2 (0.480)
220	33	M	6	N	12.2 (0.480)
477	33	K	6	J	12.2 (0.480)
478	33	M	6	J	12.2 (0.480)
221	39	K	6	N	16.5 (0.650)
222	39	M	6	N	16.5 (0.650)
479	39	K	6	J	16.5 (0.650)
480	39	M	6	J	16.5 (0.650)



SMPS Stacked MLC Capacitors



(SM9 Style) Technical Information on SMPS Capacitors

ELECTRICAL SPECIFICATIONS

Temperature Coefficient

C0G: A Temperature Coefficient - 0 ± 30 ppm/°C, -55° to +125°C
 X7R: C Temperature Coefficient - $\pm 15\%$, -55° to +125°C
 Z5U: E Temperature Coefficient - +22, -56%, +10° to +85°C

Capacitance Test (MIL-STD-202 Method 305)

C0G: 25°C, 1.0 ± 0.2 Vrms (open circuit voltage) at 1KHz
 X7R: 25°C, 1.0 ± 0.2 Vrms (open circuit voltage) at 1KHz
 Z5U: 25°C, 0.5 Vrms max (open circuit voltage) at 1KHz

Dissipation Factor 25°C

C0G: 0.15% Max @ 25°C, 1.0 ± 0.2 Vrms (open circuit voltage) at 1KHz
 X7R: 2.5% Max @ 25°C, 1.0 ± 0.2 Vrms (open circuit voltage) at 1KHz
 Z5U: 3.0% Max @ 25°C, 0.5 Vrms max (open circuit voltage) at 1KHz

Insulation Resistance 25°C (MIL-STD-202 Method 302)

C0G and X7R: 100K MΩ or 1000 MΩ-μF, whichever is less.
 Z5U: 10K MΩ or 1000 MΩ-μF, whichever is less.

Insulation Resistance 125°C (MIL-STD-202 Method 302)

C0G and X7R: 10K MΩ or 100 MΩ-μF, whichever is less.
 Z5U: 1K MΩ or 100 MΩ-μF, whichever is less.

Dielectric Withstanding Voltage 25°C (Flash Test)

C0G and X7R: 250% rated voltage for 5 seconds with 50 mA max charging current. (500 Volt units @ 750 VDC)
 Z5U: 200% rated voltage for 5 seconds with 50 mA max charging current.

Life Test (1000 hrs)

C0G and X7R: 200% rated voltage at +125°C. (500 Volt units @ 600 VDC)
 Z5U: 150% rated voltage at +85°C

Moisture Resistance (MIL-STD-202 Method 106)

C0G, X7R, Z5U: Ten cycles with no voltage applied.

Thermal Shock (MIL-STD-202 Method 107, Condition A)

Immersion Cycling (MIL-STD-202 Method 104, Condition B)

Resistance To Solder Heat (MIL-STD-202, Method 210, Condition B, for 20 seconds)

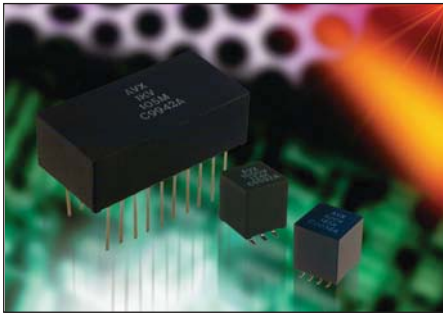

Typical ESR Performance (mΩ)

	Aluminum Electrolytic 100μF/50V	Low ESR Solid Tantalum 100μF/10V	Solid Aluminum Electrolytic 100μF/16V	MLCC SMPS 100μF/50V	MLCC SMPS 4.7μF/50V
ESR @ 10KHz	300	72	29	3	66
ESR @ 50KHz	285	67	22	2	23
ESR @ 100KHz	280	62	20	2.5	15
ESR @ 500KHz	265	56	18	4	8
ESR @ 1MHz	265	56	17	7	7.5
ESR @ 5MHz	335	72	17	12.5	8
ESR @ 10MHz	560	91	22	20	14

HOW TO ORDER

AVX Styles: SM91, SM92, SM93, SM94, SM95, SM96

SM9	1	7	C	106	M	A	N	660
AVX Style Size	Size	Voltage	Temperature Coefficient	Capacitance Code	Capacitance Tolerance	Test Level	Termination	Height
SM9 = Plastic Case	See dimensions chart	50V = 5 100V = 1 200V = 2 500V = 7	C0G = A X7R = C Z5U = E	(2 significant digits + no. of zeros) 10 pF = 100 100 pF = 101 1,000 pF = 102 22,000 pF = 223 220,000 pF = 224 1 μF = 105 10 μF = 106 100 μF = 107	C0G: J = ±5% K = ±10% M = ±20% X7R: K = ±10% M = ±20% Z = +80, -20% Z5U: Z = +80, -20% P = GMV (+100, -0%)	A = Standard B = Hi-Rel*	N = Straight Lead J = Leads formed in L = Leads formed out	See table on page 28 for max cap. per height

Note: Capacitors with X7R and Z5U dielectrics are not intended for applications across AC supply mains or AC line filtering with polarity reversal. Contact plant for recommendations.

*Hi-Rel screening for C0G and X7R only. Screening consists of 100% Group A (B Level), Subgroup 1 per MIL-PRF-49470.



SMPS Stacked MLC Capacitors

Encapsulated in DAP (Diallyl Phthalate) Case (SM9 Style)

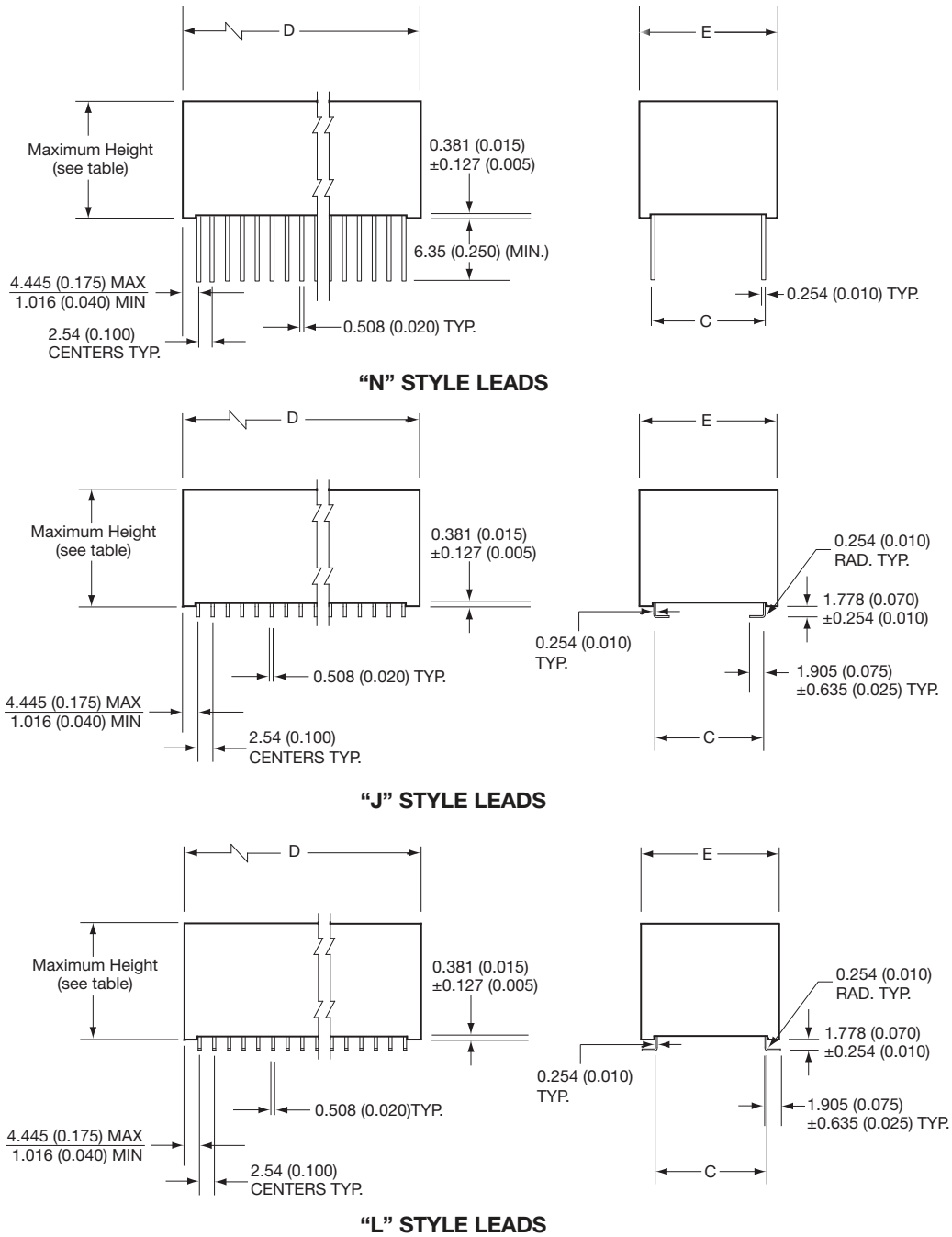

DIMENSIONS

millimeters (inches)

Case Code	± 0.635 (0.025) C	± 0.254 (0.010) D	+0.000 (0.000) -0.254 (0.010) E	No. of Leads per side*
SM91	11.4 (0.450)	54.7 (2.155)	14.7 (0.580)	20
SM92	20.3 (0.800)	41.0 (1.615)	24.1 (0.950)	15
SM93	11.4 (0.450)	29.3 (1.155)	14.7 (0.580)	10
SM94	10.2 (0.400)	12.3 (0.485)	12.3 (0.485)	4
SM95	6.35 (0.250)	9.02 (0.355)	9.02 (0.355)	3
SM96	31.8 (1.250)	54.7 (2.155)	36.3 (1.430)	20

*Leads styles N, J or L available



SMPS Stacked MLC Capacitors

Encapsulated in DAP (Diallyl Phthalate) Case (SM9 Style)



Max Capacitance (µF) Available Versus Style with Height of 0.270" - 6.86mm

AVX STYLE	SM91 _____ AN270				SM92 _____ AN270				SM93 _____ AN270				SM94 _____ AN270				SM95 _____ AN270				SM96 _____ AN270			
	50V	100V	200V	500V	50V	100V	200V	500V	50V	100V	200V	500V	50V	100V	200V	500V	50V	100V	200V	500V	50V	100V	200V	500V
C0G	1.0	.70	.40	.18	1.2	1.0	.60	.26	.47	.40	.20	.09	.16	.13	.07	.02	.05	.04	.02	.01	3.2	2.4	1.3	.50
X7R	27	12	7.0	2.6	41	18	11	4.0	18	6.0	3.6	1.3	7.5	1.8	1.1	.40	2.8	.68	.40	.16	80	40	24	9.4
Z5U	84	32	12	--	110	46	34	--	40	15	6.0	--	12	4.6	3.0	--	4.6	1.8	.72	--	260	140	92	--

Max Capacitance (µF) Available Versus Style with Height of 0.390" - 9.91mm

AVX STYLE	SM91 _____ AN390				SM92 _____ AN390				SM93 _____ AN390				SM94 _____ AN390				SM95 _____ AN390				SM96 _____ AN390			
	50V	100V	200V	500V	50V	100V	200V	500V	50V	100V	200V	500V	50V	100V	200V	500V	50V	100V	200V	500V	50V	100V	200V	500V
C0G	2.0	1.4	.80	.36	2.4	2.0	1.2	.52	1.0	.80	.40	.18	.32	.26	.14	.05	.10	.08	.05	.02	6.4	4.8	2.6	1.0
X7R	54	24	14	5.2	82	36	22	8.0	36	12	7.2	2.6	15	3.6	2.2	.80	5.6	1.3	.80	.32	160	80	48	18
Z5U	160	64	24	--	230	92	68	--	80	30	12	--	24	9.2	6.0	--	9.2	3.6	1.4	--	520	280	180	--

Max Capacitance (µF) Available Versus Style with Height of 0.530" - 13.46mm

AVX STYLE	SM91 _____ AN530				SM92 _____ AN530				SM93 _____ AN530				SM94 _____ AN530				SM95 _____ AN530				SM96 _____ AN530			
	50V	100V	200V	500V	50V	100V	200V	500V	50V	100V	200V	500V	50V	100V	200V	500V	50V	100V	200V	500V	50V	100V	200V	500V
C0G	3.0	2.1	1.2	.54	3.6	3.0	1.8	.78	1.5	1.2	.60	.27	.48	.39	.21	.07	.15	.12	.07	.03	9.6	7.2	3.9	1.5
X7R	82	36	21	7.8	120	54	33	12	54	18	10	3.9	22	5.4	3.3	1.2	8.2	2.0	1.2	.48	240	120	72	28
Z5U	250	96	36	--	350	130	100	--	120	45	18	--	36	13	9.0	--	13	5.4	2.1	--	780	430	270	--

Max Capacitance (µF) Available Versus Style with Height of 0.660" - 16.76mm

AVX STYLE	SM91 _____ AN660				SM92 _____ AN660				SM93 _____ AN660				SM94 _____ AN660				SM95 _____ AN660				SM96 _____ AN660			
	50V	100V	200V	500V	50V	100V	200V	500V	50V	100V	200V	500V	50V	100V	200V	500V	50V	100V	200V	500V	50V	100V	200V	500V
C0G	4.0	2.8	1.6	.72	4.8	4.0	2.4	1.0	2.0	1.6	.80	.36	.64	.52	.28	.10	.20	.16	.10	.04	12	9.6	5.2	2.0
X7R	110	48	28	10	160	72	44	16	72	24	14	5.2	30	7.2	4.4	1.6	10	2.7	1.6	.64	320	160	96	37
Z5U	330	120	48	--	470	180	130	--	160	60	24	--	48	18	12	--	18	7.2	2.8	--	1000	570	360	--

Max Capacitance (µF) Available Versus Style with Height of 0.800" - 20.3mm

AVX STYLE	SM91 _____ AN800				SM92 _____ AN800				SM93 _____ AN800				SM94 _____ AN800				SM95 _____ AN800				SM96 _____ AN800			
	50V	100V	200V	500V	50V	100V	200V	500V	50V	100V	200V	500V	50V	100V	200V	500V	50V	100V	200V	500V	50V	100V	200V	500V
C0G	5.0	3.5	2.0	.90	6.0	5.0	3.0	1.3	2.5	2.0	1.0	.47	.80	.65	.35	.12	.25	.20	.12	.05	16	12	6.5	2.5
X7R	130	60	35	13	200	90	55	20	90	30	18	6.5	36	9.0	5.5	2.0	12	3.4	2.0	.80	400	200	120	47
Z5U	420	160	60	--	590	230	170	--	200	75	30	--	60	23	15	--	23	9.0	3.6	--	1300	720	460	--

RoHS Compliant SMPS Stacked MLC Capacitors

(RM Style) Technical Information on SMPS Capacitors

ELECTRICAL SPECIFICATIONS

Temperature Coefficient

C0G: A Temperature Coefficient - 0 ±30 ppm/°C, -55° to +125°C
 X7R: C Temperature Coefficient - ±15%, -55° to +125°C
 Z5U: E Temperature Coefficient - +22, -56%, +10° to +85°C

Capacitance Test (MIL-STD-202 Method 305)

C0G: 25°C, 1.0±0.2 Vrms (open circuit voltage) at 1KHz
 X7R: 25°C, 1.0±0.2 Vrms (open circuit voltage) at 1KHz
 Z5U: 25°C, 0.5 Vrms max (open circuit voltage) at 1KHz

Dissipation Factor 25°C

C0G: 0.15% Max @ 25°C, 1.0±0.2 Vrms (open circuit voltage) at 1KHz
 X7R: 2.5% Max @ 25°C, 1.0±0.2 Vrms (open circuit voltage) at 1KHz
 Z5U: 3.0% Max @ 25°C, 0.5 Vrms max (open circuit voltage) at 1KHz

Insulation Resistance 25°C (MIL-STD-202 Method 302)

C0G and X7R: 100K MΩ or 1000 MΩ-μF, whichever is less.
 Z5U: 10K MΩ or 1000 MΩ-μF, whichever is less.

Insulation Resistance 125°C (MIL-STD-202 Method 302)

C0G and X7R: 10K MΩ or 100 MΩ-μF, whichever is less.
 Z5U: 1K MΩ or 100 MΩ-μF, whichever is less.

Dielectric Withstanding Voltage 25°C (Flash Test)

C0G and X7R: 250% rated voltage for 5 seconds with 50 mA max charging current. (500 Volt units @ 750 VDC)
 Z5U: 200% rated voltage for 5 seconds with 50 mA max charging current.

Life Test (1000 hrs)

C0G and X7R: 200% rated voltage at +125°C. (500 Volt units @ 600 VDC)
 Z5U: 150% rated voltage at +85°C

Moisture Resistance (MIL-STD-202 Method 106)

C0G, X7R, Z5U: Ten cycles with no voltage applied.

Thermal Shock (MIL-STD-202 Method 107, Condition A)

Immersion Cycling (MIL-STD-202 Method 104, Condition B)

Resistance To Solder Heat (MIL-STD-202, Method 210, Condition B, for 20 seconds)

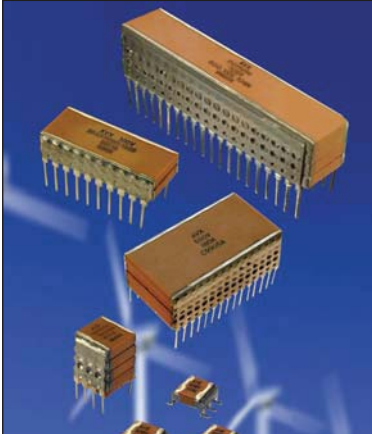

Typical ESR Performance (mΩ)					
	Aluminum Electrolytic 100μF/50V	Low ESR Solid Tantalum 100μF/10V	Solid Aluminum Electrolytic 100μF/16V	MLCC SMPS 100μF/50V	MLCC SMPS 4.7μF/50V
ESR @ 10KHz	300	72	29	3	66
ESR @ 50KHz	285	67	22	2	23
ESR @ 100KHz	280	62	20	2.5	15
ESR @ 500KHz	265	56	18	4	8
ESR @ 1MHz	265	56	17	7	7.5
ESR @ 5MHz	335	72	17	12.5	8
ESR @ 10MHz	560	91	22	20	14

HOW TO ORDER

AVX Styles: RM-1, RM-2, RM-3, RM-4, RM-5, RM-6

RM0	1	7	C	106	M	A	N	650
AVX Style RM0 = Uncoated RM5 = Epoxy Coated	Size See Dimensions chart	Voltage 50V = 5 100V = 1 200V = 2 500V = 7	Temperature Coefficient C0G = A X7R = C Z5U = E	Capacitance Code (2 significant digits + number of zeros) 10 pF = 100 100 pF = 101 1,000 pF = 102 22,000 pF = 223 220,000 pF = 224 1 μF = 105 10 μF = 106 100 μF = 107	Capacitance Tolerance COG: J = ±5% K = ±10% M = ±20% X7R: K = ±10% M = ±20% Z = +80%, -20% Z5U: M = ±20% Z = +80%, -20% P = GMV (+100, -0%)	Test Level A = Standard	Termination N = Straight Lead J = Leads formed in L = Leads formed out P = P Style Leads Z = Z Style Leads	Height Max Dimension "A" 120 = 0.120" 240 = 0.240" 360 = 0.360" 480 = 0.480" 650 = 0.650"



Note: Capacitors with X7R and Z5U dielectrics are not intended for applications across AC supply mains or AC line filtering with polarity reversal. Contact plant for recommendations.

RoHS Compliant SMPS Stacked MLC Capacitors



(RM Style) Surface Mount and Thru-Hole Styles (RM0, RM5)

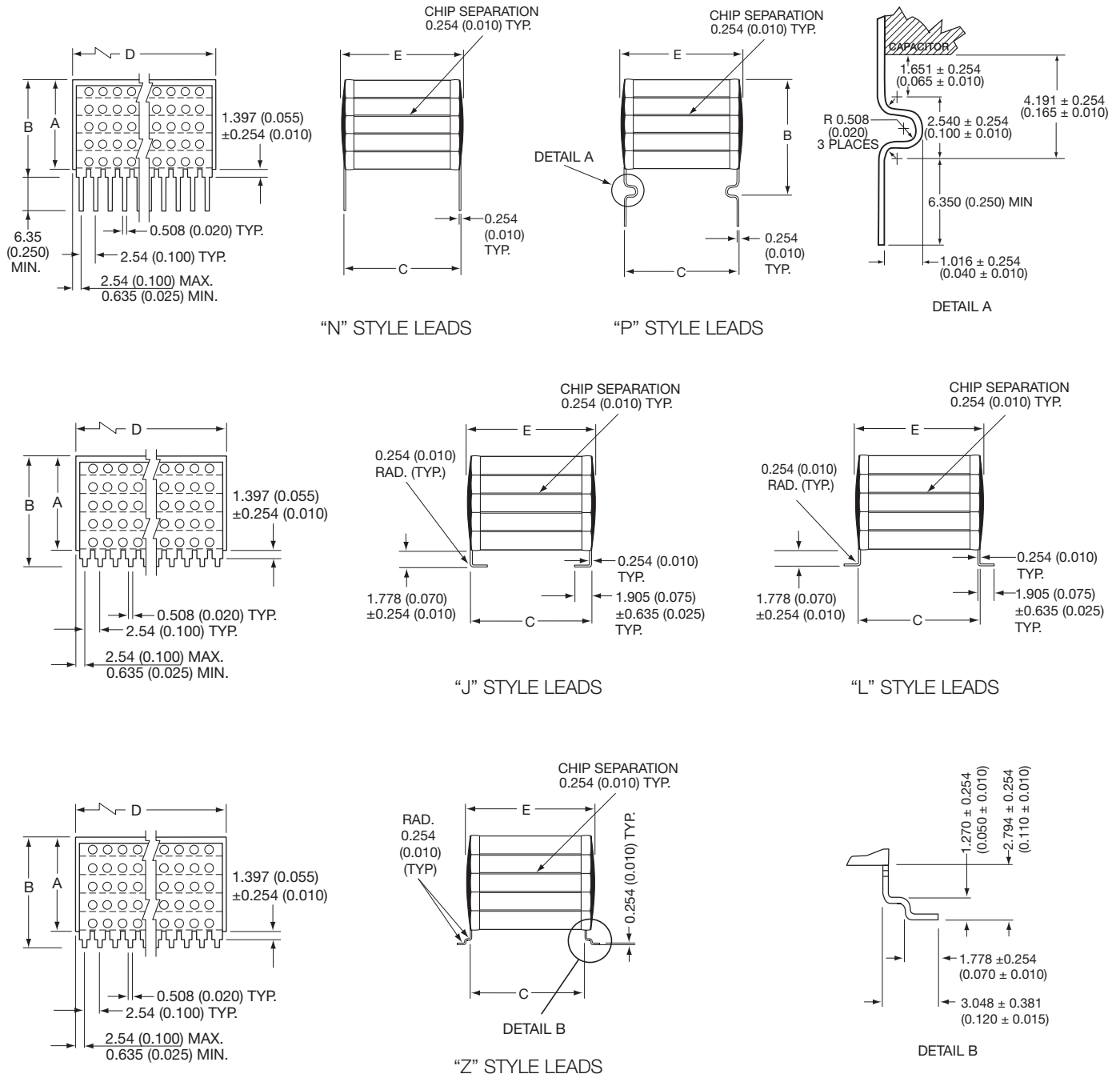

DIMENSIONS

millimeters (inches)

Style	A (max.)	B (max.)	C ±.635 (±0.025)	D ±.635 (±0.025)	E (max.)	No. of Leads per side
RM-1	See page 31 for maximum "A" Dimension	For "N" Style Leads: "A" Dimension Plus 1.651 (0.065)	11.4 (0.450)	52.1 (2.050)	12.7 (0.500)	20
RM-2		For "J" & "L" Style Leads: "A" Dimension Plus 2.032 (0.080)	20.3 (0.800)	38.4 (1.510)	22.1 (0.870)	15
RM-3		For "P" Style Leads: "A" Dimension Plus 4.445 (0.175)	11.4 (0.450)	26.7 (1.050)	12.7 (0.500)	10
RM-4		For "Z" Style Leads: "A" Dimension Plus 3.048 (0.120)	10.2 (0.400)	10.2 (0.400)	11.2 (0.440)	4
RM-5			6.35 (0.250)	6.35 (0.250)	7.62 (0.300)	3
RM-6			31.8 (1.250)	52.1 (2.050)	34.3 (1.350)	20

Note: For RM5 add 0.127 (0.005) to max. and nominal dimensions A, B, D, & E



RoHS Compliant SMPS Stacked MLC Capacitors (RM Style)



Max Capacitance (µF) Available Versus Style with Height (A) of 0.120" - 3.05mm

AVX STYLE	RM01 _____ AN120				RM02 _____ AN120				RM03 _____ AN120				RM04 _____ AN120				RM05 _____ AN120				RM06 _____ AN120			
	50V	100V	200V	500V	50V	100V	200V	500V	50V	100V	200V	500V	50V	100V	200V	500V	50V	100V	200V	500V	50V	100V	200V	500V
C0G	1.0	.70	.40	.18	1.2	1.0	.60	.26	.47	.40	.20	.09	.16	.13	.07	.02	.05	.04	.02	.01	3.2	2.4	1.3	.50
X7R	27	12	7.0	2.6	41	18	11	4.0	18	6.0	3.6	1.3	7.5	1.8	1.1	.40	2.8	.68	.40	.16	80	40	24	9.4
Z5U	84	32	12	--	110	46	34	--	40	15	6.0	--	12	4.6	3.0	--	4.6	1.8	.72	--	260	140	92	--

Max Capacitance (µF) Available Versus Style with Height (A) of 0.240" - 6.10mm

AVX STYLE	RM01 _____ AN240				RM02 _____ AN240				RM03 _____ AN240				RM04 _____ AN240				RM05 _____ AN240				RM06 _____ AN240			
	50V	100V	200V	500V	50V	100V	200V	500V	50V	100V	200V	500V	50V	100V	200V	500V	50V	100V	200V	500V	50V	100V	200V	500V
C0G	2.0	1.4	.80	.36	2.4	2.0	1.2	.52	1.0	.80	.40	.18	.32	.26	.14	.05	.10	.08	.05	.02	6.4	4.8	2.6	1.0
X7R	54	24	14	5.2	82	36	22	8.0	36	12	7.2	2.6	15	3.6	2.2	.80	5.6	1.3	.80	.32	160	80	48	18
Z5U	160	64	24	--	230	92	68	--	80	30	12	--	24	9.2	6.0	--	9.2	3.6	1.4	--	520	280	180	--

Max Capacitance (µF) Available Versus Style with Height (A) of 0.360" - 9.14mm

AVX STYLE	RM01 _____ AN360				RM02 _____ AN360				RM03 _____ AN360				RM04 _____ AN360				RM05 _____ AN360				RM06 _____ AN360			
	50V	100V	200V	500V	50V	100V	200V	500V	50V	100V	200V	500V	50V	100V	200V	500V	50V	100V	200V	500V	50V	100V	200V	500V
C0G	3.0	2.1	1.2	.54	3.6	3.0	1.8	.78	1.5	1.2	.60	.27	.48	.39	.21	.07	.15	.12	.07	.03	9.6	7.2	3.9	1.5
X7R	82	36	21	7.8	120	54	33	12	54	18	10	3.9	22	5.4	3.3	1.2	8.2	2.0	1.2	.48	240	120	72	28
Z5U	250	96	36	--	350	130	100	--	120	45	18	--	36	13	9.0	--	13	5.4	2.1	--	780	430	270	--

Max Capacitance (µF) Available Versus Style with Height (A) of 0.480" - 12.2mm

AVX STYLE	RM01 _____ AN480				RM02 _____ AN480				RM03 _____ AN480				RM04 _____ AN480				RM05 _____ AN480				RM06 _____ AN480			
	50V	100V	200V	500V	50V	100V	200V	500V	50V	100V	200V	500V	50V	100V	200V	500V	50V	100V	200V	500V	50V	100V	200V	500V
C0G	4.0	2.8	1.6	.72	4.8	4.0	2.2	1.0	2.0	1.6	.80	.36	.64	.52	.28	.10	.20	.16	.10	.04	12	9.6	5.2	2.0
X7R	110	48	28	10	160	72	44	16	72	24	14	5.2	30	7.2	4.4	1.6	10	2.7	1.6	.64	320	160	96	37
Z5U	330	120	48	--	470	180	130	--	160	60	24	--	48	18	12	--	18	7.2	2.8	--	1000	570	360	--

Max Capacitance (µF) Available Versus Style with Height (A) of 0.650" - 16.5mm

AVX STYLE	RM01 _____ AN650				RM02 _____ AN650				RM03 _____ AN650				RM04 _____ AN650				RM05 _____ AN650				RM06 _____ AN650			
	50V	100V	200V	500V	50V	100V	200V	500V	50V	100V	200V	500V	50V	100V	200V	500V	50V	100V	200V	500V	50V	100V	200V	500V
C0G	5.0	3.5	2.0	.90	6.0	5.0	3.0	1.3	2.5	2.0	1.0	.47	.80	.65	.35	.12	.25	.20	.12	.05	16	12	6.5	2.5
X7R	130	60	35	13	200	90	55	20	90	30	18	6.5	36	9.0	5.5	2.0	12	3.4	2.0	.80	400	200	120	47
Z5U	420	160	60	--	590	230	170	--	200	75	30	--	60	23	15	--	23	9.0	3.6	--	1300	720	460	--

SMPS Stacked MLC Capacitors



SMX Style for High Temperature Applications up to 200°C

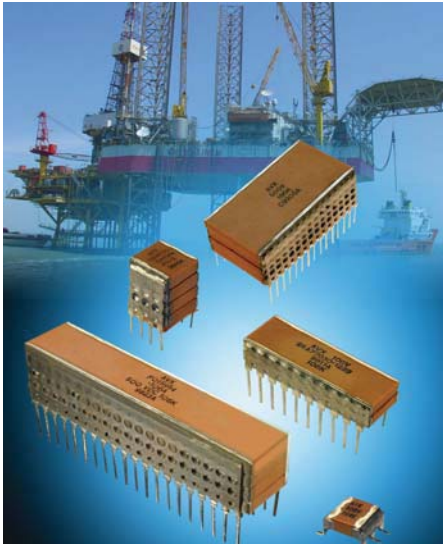

SMX-style, stacked Switch Mode Power Supply Capacitors (SMPS) utilizing Multilayer Ceramic (MLCC) construction are ideally suited for high temperature applications up to 200°C. This product is intended for downhole oil exploration, including logging while drilling, geophysical probes, as well as space and aerospace electronics. The high temperature solder utilized in the construction of SMX-style parts assures reliable operation in harsh environments. The wide product offering provides designers a solution for high capacitance value and high voltage capacitors rated at 200°C. The SMX-style capacitors are ideally suited for applications as DC filters in high power, high frequency motor drives, high pulsed-current circuitry, as well as low power electronics.

SMX-style, SMPS capacitors are characterized with excellent performance in comparison to wet tantalum products. The main benefits of SMX-product over wet tantalum capacitors include:

- Much lower ESR and lower losses
- Excellent capacitance retention with frequency
- Excellent high frequency performance
- Low DC leakage current
- Much higher current handling capabilities

Typical Extended Temperature TCC
Characterization of C0G, SMPS Capacitors
 Test conditions: 1 Vrms, 1 kHz, 0 VDC bias

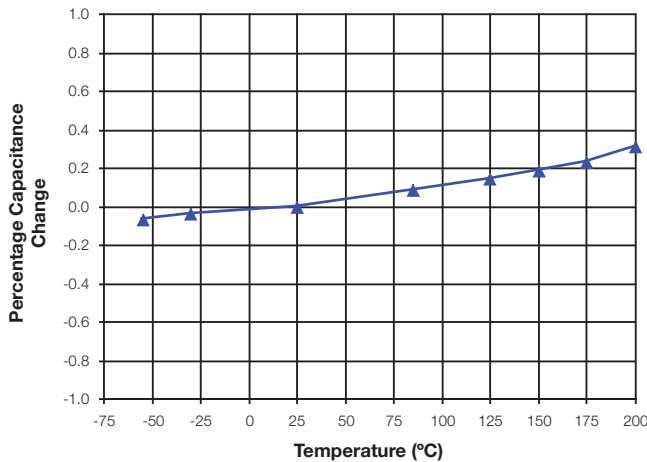

Typical Extended Temperature TCC
Characterization of X7R/X9U, SMPS Capacitors
 Test conditions: 1 Vrms, 1 kHz, 0 VDC bias

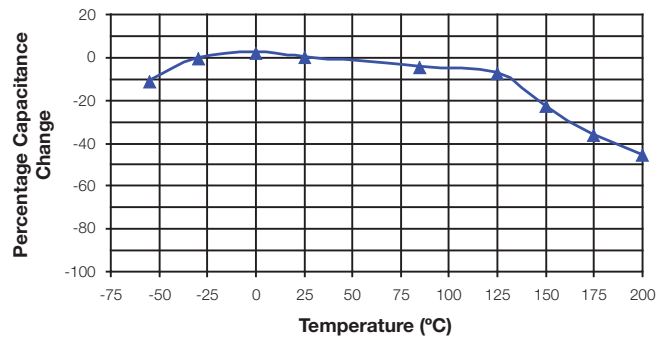

Typical Extended Temperature IR Characterization of
C0G, SMPS Capacitors

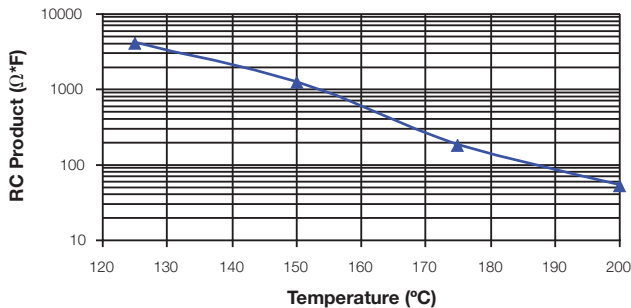

Typical Extended Temperature IR Characterization of
X7R/X9U, SMPS Capacitors

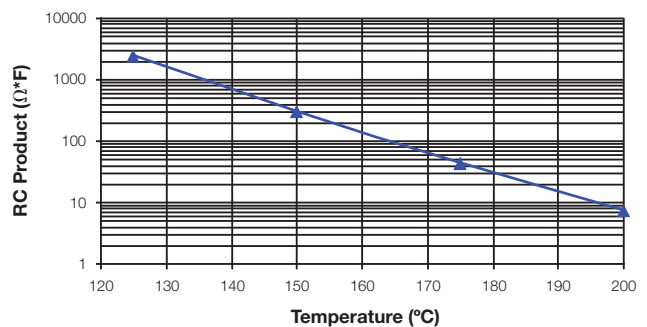

SMPS Stacked MLC Capacitors



SMX Style for High Temperature Applications up to 200°C



ELECTRICAL SPECIFICATIONS

Temperature Coefficient

C0G: A Temperature Coefficient 0 ±30 ppm/°C, -55° to +200°C
 X7R/X9U: C Temperature Coefficient ±15%, -55°C to +125°C
 +15% - 56%, -55°C to +200°C

Capacitance Test (MIL-STD-202 Method 305)

25°C, 1.0±0.2 Vrms (open circuit voltage) at 1KHz

Dissipation Factor 25°C

C0G: 0.15% Max @ 25°C, 1.0±0.2 Vrms (open circuit voltage) at 1KHz
 X7R/X9U: 2.5% Max @ 25°C, 1.0±0.2 Vrms (open circuit voltage) at 1KHz

Insulation Resistance 25°C (MIL-STD-202 Method 302)

100K MΩ or 1000 MΩ-μF, whichever is less.

Insulation Resistance 125°C (MIL-STD-202 Method 302)

10K MΩ or 100 MΩ-μF, whichever is less.

Insulation Resistance 200°C (MIL-STD-202 Method 302)

100 MΩ or 1 MΩ -μF, whichever is less.

Dielectric Withstanding Voltage 25°C (Flash Test)

250% rated voltage for 5 seconds with 50 mA max charging current. (500 Volt units @ 750 VDC)

Moisture Resistance (MIL-STD-202 Method 106)

Ten cycles with no voltage applied.

Thermal Shock (MIL-STD-202 Method 107, Condition A)

Immersion Cycling (MIL-STD-202 Method 104, Condition B)

Resistance To Solder Heat (MIL-STD-202, Method 210, Condition B, for 20 seconds)

HOW TO ORDER

AVX Styles: SMX1, SMX2, SMX3, SMX4, SMX5, SMX6

SMX	1	7	C	106	M	A	N	650
AVX Style SMX = Uncoated	Size See Dimensions chart	Voltage 25 = 3 50V = 5 100V = 1 200V = 2 500V = 7	Temperature Coefficient C0G = A X7R/X9U = C	Capacitance Code (2 significant digits + number of zeros) 10 pF = 100 100 pF = 101 1,000 pF = 102 22,000 pF = 223 220,000 pF = 224 1 μF = 105 10 μF = 106 100 μF = 107	Capacitance Tolerance C0G: J = ±5% K = ±10% M = ±20% X7R: K = ±10% M = ±20% Z = +80%, -20%	Test Level A = Standard	Termination N = Straight Lead J = Leads formed in L = Leads formed out P = P Style Leads Z = Z Style Leads	Height Max Dimension "A" 120 = 0.120" 240 = 0.240" 360 = 0.360" 480 = 0.480" 650 = 0.650"

Note: Capacitors with X7R/X9U dielectric is not intended for applications across AC supply mains or AC line filtering with polarity reversal. Contact plant for recommendations.

SMPS Stacked MLC Capacitors



SMX Style for High Temperature Applications up to 200°C

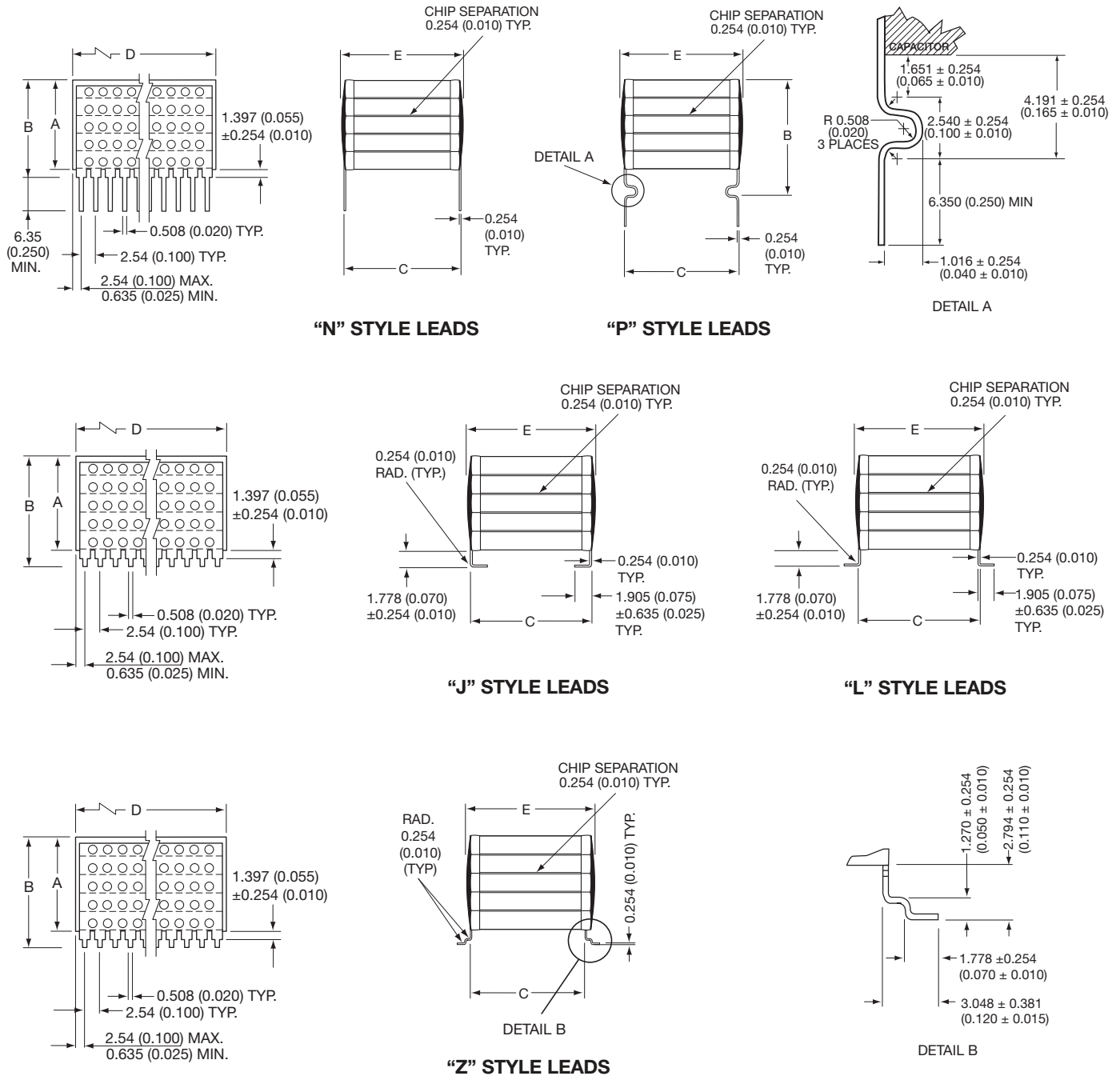

DIMENSIONS

millimeters (inches)

Style	A (max.)	B (max.)	C ±.635 (±0.025)	D ±.635 (±0.025)	E (max.)	No. of Leads per side
SMX1	See page 35 for maximum "A" Dimension	For "N" Style Leads: "A" Dimension Plus 1.651 (0.065) For "J" & "L" Style Leads: "A" Dimension Plus 2.032 (0.080) For "P" Style Leads: "A" Dimension Plus 4.445 (0.175) For "Z" Style Leads: "A" Dimension Plus 3.048 (0.120)	11.4 (0.450)	52.1 (2.050)	12.7 (0.500)	20
SMX2			20.3 (0.800)	38.4 (1.510)	22.1 (0.870)	15
SMX3			11.4 (0.450)	26.7 (1.050)	12.7 (0.500)	10
SMX4			10.2 (0.400)	10.2 (0.400)	11.2 (0.440)	4
SMX5			6.35 (0.250)	6.35 (0.250)	7.62 (0.300)	3
SMX6			31.8 (1.250)	52.1 (2.050)	34.3 (1.350)	20

SMPS Stacked MLC Capacitors



SMX Style for High Temperature Applications up to 200°C

Max Capacitance (µF) Available Versus Style with Height (A) of 0.120" - 3.05mm

AVX STYLE	SMX1					AN120					SMX2					AN120					SMX3					AN120					SMX4					AN120					SMX5					AN120					SMX6					AN120				
	25V	50V	100V	200V	500V	25V	50V	100V	200V	500V	25V	50V	100V	200V	500V	25V	50V	100V	200V	500V	25V	50V	100V	200V	500V	25V	50V	100V	200V	500V	25V	50V	100V	200V	500V	25V	50V	100V	200V	500V	25V	50V	100V	200V	500V	25V	50V	100V	200V	500V										
CoG	1.0	.70	.40	.18	.068	1.2	1.0	.60	.26	.10	.50	.40	.20	.09	.033	.16	.13	.07	.02	.01	.05	.04	.02	.01	.0039	3.2	2.4	1.3	.50	.20	22	12	7.0	2.6	1.0	33	18	11	4.0	1.5	11	6.0	3.6	1.3	.50	3.3	1.8	1.1	.40	.15	1.2	.68	.40	.16	.056	68	40	24	9.4	3.3
X7R/X9U	22	12	7.0	2.6	1.0	33	18	11	4.0	1.5	11	6.0	3.6	1.3	.50	3.3	1.8	1.1	.40	.15	1.2	.68	.40	.16	.056	68	40	24	9.4	3.3																														

Max Capacitance (µF) Available Versus Style with Height (A) of 0.240" - 6.10mm

AVX STYLE	SMX1					AN240					SMX2					AN240					SMX3					AN240					SMX4					AN240					SMX5					AN240					SMX6					AN240				
	25V	50V	100V	200V	500V	25V	50V	100V	200V	500V	25V	50V	100V	200V	500V	25V	50V	100V	200V	500V	25V	50V	100V	200V	500V	25V	50V	100V	200V	500V	25V	50V	100V	200V	500V	25V	50V	100V	200V	500V	25V	50V	100V	200V	500V															
CoG	2.0	1.4	.80	.36	.13	2.4	2.0	1.2	.52	.20	1.0	.80	.40	.18	.068	.33	.26	.14	.05	.02	.10	.08	.05	.02	.0078	6.4	4.8	2.6	1.0	.40	44	24	14	5.2	2.0	66	36	22	8.0	3.0	22	12	7.2	2.6	1.0	6.6	3.6	2.2	.80	.30	2.4	1.3	.80	.32	.110	130	80	48	18	6.6
X7R/X9U	44	24	14	5.2	2.0	66	36	22	8.0	3.0	22	12	7.2	2.6	1.0	6.6	3.6	2.2	.80	.30	2.4	1.3	.80	.32	.110	130	80	48	18	6.6																														

Max Capacitance (µF) Available Versus Style with Height (A) of 0.360" - 9.14mm

AVX STYLE	SMX1					AN360					SMX2					AN360					SMX3					AN360					SMX4					AN360					SMX5					AN360					SMX6					AN360				
	25V	50V	100V	200V	500V	25V	50V	100V	200V	500V	25V	50V	100V	200V	500V	25V	50V	100V	200V	500V	25V	50V	100V	200V	500V	25V	50V	100V	200V	500V	25V	50V	100V	200V	500V	25V	50V	100V	200V	500V	25V	50V	100V	200V	500V															
CoG	3.0	2.1	1.2	.54	.22	3.6	3.0	1.8	.78	.30	1.5	1.2	.60	.27	.10	.48	.39	.21	.07	.03	.15	.12	.07	.03	.011	10	7.2	3.9	1.5	.60	68	36	21	7.8	3.0	100	54	33	12	4.5	33	18	10	3.9	1.5	10	5.4	3.3	1.2	.47	3.6	2.0	1.2	.48	.160	200	120	72	28	10
X7R/X9U	68	36	21	7.8	3.0	100	54	33	12	4.5	33	18	10	3.9	1.5	10	5.4	3.3	1.2	.47	3.6	2.0	1.2	.48	.160	200	120	72	28	10																														

Max Capacitance (µF) Available Versus Style with Height (A) of 0.480" - 12.2mm

AVX STYLE	SMX1					AN480					SMX2					AN480					SMX3					AN480					SMX4					AN480					SMX5					AN480					SMX6					AN480				
	25V	50V	100V	200V	500V	25V	50V	100V	200V	500V	25V	50V	100V	200V	500V	25V	50V	100V	200V	500V	25V	50V	100V	200V	500V	25V	50V	100V	200V	500V	25V	50V	100V	200V	500V	25V	50V	100V	200V	500V	25V	50V	100V	200V	500V															
CoG	4.0	2.8	1.6	.72	.27	4.8	4.0	2.2	1.0	.40	2.0	1.6	.80	.36	.130	.64	.52	.28	.10	.04	.20	.16	.10	.04	.015	13	9.6	5.2	2.0	.80	88	48	28	10	4.0	130	72	44	16	6.0	44	24	14	5.2	2.0	13	7.2	4.4	1.6	.60	4.8	2.7	1.6	.64	.22	270	160	96	37	13
X7R/X9U	88	48	28	10	4.0	130	72	44	16	6.0	44	24	14	5.2	2.0	13	7.2	4.4	1.6	.60	4.8	2.7	1.6	.64	.22	270	160	96	37	13																														

Max Capacitance (µF) Available Versus Style with Height (A) of 0.650" - 16.5mm

AVX STYLE	SMX1					AN650					SMX2					AN650					SMX3					AN650					SMX4					AN650					SMX5					AN650					SMX6					AN650				
	25V	50V	100V	200V	500V	25V	50V	100V	200V	500V	25V	50V	100V	200V	500V	25V	50V	100V	200V	500V	25V	50V	100V	200V	500V	25V	50V	100V	200V	500V	25V	50V	100V	200V	500V	25V	50V	100V	200V	500V	25V	50V	100V	200V	500V															
CoG	5.0	3.5	2.0	.90	.34	6.0	5.0	3.0	1.3	.50	2.5	2.0	1.0	.45	.160	.82	.65	.35	.12	.05	.25	.20	.12	.05	.019	16	12	6.5	2.5	1.0	110	60	35	13	5.0	160	90	55	20	7.5	56	30	18	6.5	2.5	16	9.0	5.5	2.0	.80	6.0	3.4	2.0	.80	.28	340	200	120	47	16
X7R/X9U	110	60	35	13	5.0	160	90	55	20	7.5	56	30	18	6.5	2.5	16	9.0	5.5	2.0	.80	6.0	3.4	2.0	.80	.28	340	200	120	47	16																														

SMPS Capacitors Chip Assemblies

CH/CV - Radial, Dual-in-Line, 4 Terminal/SMT 'J' & 'L' Ranges

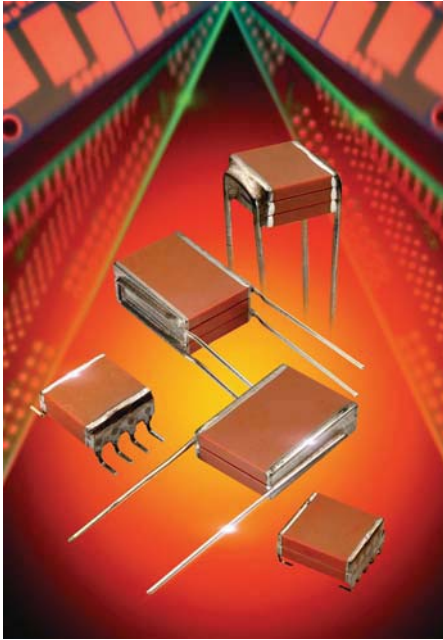

10nF to 180 μ F
50V to 500 VDC
-55°C to +125°C

BS9100 approved
Low ESR/ESL
1B/C0G and 2C1/X7R Dielectrics

This range allows SMPS engineers to select the best volumetric solution for input and output filter applications in high reliability designs. Utilizing advanced multilayer ceramic techniques to minimize ESR/ESL giving high current handling properties appropriate for filtering, smoothing and decoupling circuits.

ELECTRICAL SPECIFICATIONS

Temperature Coefficient CECC 30 000, (4.24.1)

1B/C0G: A Temperature Coefficient - 0 ± 30 ppm/°C, -55° to +125°C
2C1/X7R: C Temperature Characteristic - $\pm 15\%$, -55° to +125°C

Capacitance Test 25°C

1B/C0G: Measured at 1 VRMS max at 1KHz (1MHz for 100 pF or less)
2C1/X7R: Measured at 1 VRMS max at 1KHz

Dissipation Factor 25°C

1B/C0G: 0.15% max at 1KHz, 1 VRMS max (1MHz for 100 pF or less)
2C1/X7R: 2.5% max at 1KHz, 1 VRMS max

Insulation Resistance 25°C

1B/C0G & 2C1/X7R: 100K megohms or 1000 megohms- μ F, whichever is less

Dielectric Withstanding Voltage 25°C (Flash Test)

1B/C0G & 2C1/X7R: 250% rated voltage for 5 seconds with 50 mA max charging current. (500 Volt units @ 150% rated voltage)

Dielectric Withstanding Voltage 25°C (Flash Test)

1B/C0G & 2C1/X7R: 250% rated voltage for 5 seconds with 50 mA max charging current. (500 Volt units @ 150% rated voltage)

Life Test (1000 hrs) CECC 30 000 (4.23)

1B/C0G & 2C1/X7R: 200% rated voltage at +125°C. (500 Volt units @ 120% rated voltage)

Damp Heat IEC 68-2-3, 56 days.

Thermal Shock IEC 68-2-14

-55°C to +125°C, 5 cycles

Resistance to Solder Heat IEC 68-2-20

Vibration IEC 68-2-6

10Hz - 2000Hz, 0.75mm or 98m/sec², 6 hrs.

Bump IEC 68-2-29

390m/sec², 4000 bumps

MARKING

CH and CV 4x, 5x, 81-84

A5C	Top line A (AVX). Voltage code, dielectric code.
225K	Middle line capacitance code, tolerance code.
xxxxxx	Bottom line 6 digit batch code.

Other CH, CV Styles

AVX	Top line AVX.
5C	Second line voltage code, dielectric code.
156M	Third line capacitance code, tolerance code.
xxxxxx	Bottom line, 6 digit batch code.

SMPS Capacitors (CV Style)



Chip Assemblies

VERTICALLY MOUNTED RADIAL PRODUCT

Part Number format (CVxxxxxxxxxxA2)

Typical Part Number CV525C106MA30A2

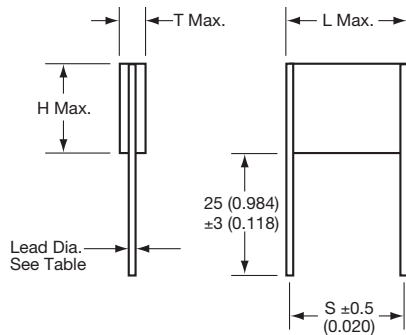

DIMENSIONS

millimeters (inches)

Style	L (max)	H (max)	S (nom)	Lead Dia (nom)
CV41-44	10.6 (0.417)	8.7 (0.342)	8.2 (0.322)	0.7 (0.028)
CV51-54	11.9 (0.468)	10.7 (0.421)	10.2 (0.400)	0.9 (0.035)
CV61-64	16.5 (0.649)	13.6 (0.535)	15.2 (0.600)	0.9 (0.035)
CV71-74	17.8 (0.700)	21.6 (0.850)	15.2 (0.600)	0.9 (0.035)
CV76-79	22.7 (0.893)	16.6 (0.653)	21.2* (0.834)	0.9 (0.035)

*Tolerance ± 0.8

millimeters (inches)

Style	T max
CV41/51/61/71/76	3.80 (0.150)
CV42/52/62/72/77	7.40 (0.291)
CV43/53/63/73/78	11.1 (0.437)
CV44/54/64/74/79	14.8 (0.583)

VERTICALLY MOUNTED 4 TERMINAL RADIAL PRODUCT

Part Number format (CVxxxxxxxx3xx4)

Typical Part Number CV435C106MA30A4

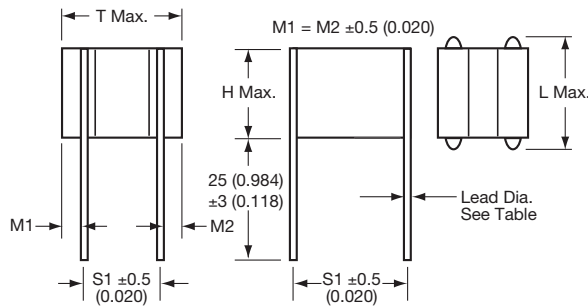

DIMENSIONS

millimeters (inches)

Style	L (max)	H (max)	S (nom)	Lead Dia (nom)
CV43-44	10.6 (0.417)	8.7 (0.342)	8.2 (0.322)	0.7 (0.028)
CV53-54	11.9 (0.468)	10.7 (0.421)	10.2 (0.400)	0.9 (0.035)
CV63-64	16.5 (0.649)	13.6 (0.535)	15.2 (0.600)	0.9 (0.035)
CV73-74	17.8 (0.700)	21.6 (0.850)	15.2 (0.600)	0.9 (0.035)
CV78-79	22.7 (0.893)	16.6 (0.653)	21.2* (0.834)	0.9 (0.035)

*Tolerance ± 0.8 (0.031)

millimeters (inches)

Style	T max	S1
CV43/53/63/73/78	11.1 (0.437)	5.08 (0.200)
CV44/54/64/74/79	14.8 (0.583)	7.62 (0.300)

Note 1. This style is only available in 3 & 4 chip assemblies

HOW TO ORDER

Style Code	Size Code	Voltage Code	Dielectric Code	Capacitance Code	Capacitance Tolerance	Specification Code	Finish Code	Lead Dia. Code	Lead Space Code	Lead Style Code
CV	52	5	C	106	M	A	3	0	A	2
(see product section)		5 = 50V 1 = 100V 2 = 200V 7 = 500V	A = C0G C = X7R	(2 significant digits + no. of zeros) eg. 105 = 1 μF 106 = 10 μF 107 = 100 μF	C0G: J = ±5% K = ±10% M = ±20% X7R: K = ±10% M = ±20% P = +100, -0%	A = Non-customized	3 = Uncoated 8 = Coated (classified as uninsulated)	0 = Standard	A = Standard	2 = 2 Terminal 4 = 4 Terminal See Note 1 above

Note: See page 122 for How to Order BS9100 parts



SMPS Capacitors (CH Style)



Chip Assemblies

HORIZONTALLY MOUNTED 4 TERMINAL RADIAL PRODUCT

Part Number format (CHxxxxxxxx3xx4)

Typical Part Number CH782C106MA30A4

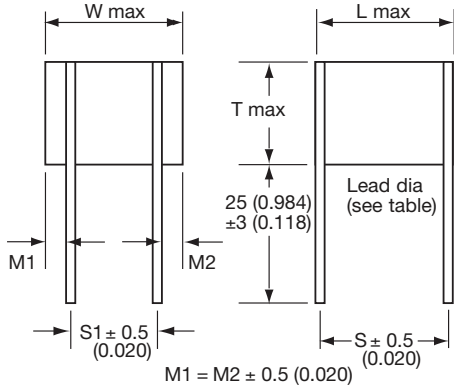

DIMENSIONS

millimeters (inches)

Style	L (max)	W (max)	S (nom)	S Lead Dia (nom)	S1 (nom)
CH42-44	10.6 (0.417)	8.7 (0.342)	8.2 (0.322)	0.7 (0.028)	5.08 (0.200)
CH52-54	11.9 (0.468)	10.7 (0.421)	10.2 (0.400)	0.9 (0.035)	7.62 (0.300)
CH62-64	16.5 (0.649)	13.6 (0.535)	15.2 (0.600)	0.9 (0.035)	7.62 (0.300)
CH72-74	17.8 (0.700)	21.6 (0.850)	15.2 (0.600)	0.9 (0.035)	15.2 (0.600)
CH77-79	22.7 (0.893)	16.6 (0.653)	21.2* (0.834)	0.9 (0.035)	10.2 (0.400)
CH82-84	14.1 (0.555)	38.2 (1.503)	10.2 (0.400)	0.9 (0.035)	27.9 (1.100)
CH87-89	17.8 (0.700)	38.2 (1.503)	15.2 (0.600)	1.0 (0.039)	27.9 (1.100)
CH92-94	22.7 (0.893)	40.6 (1.598)	21.2* (0.834)	1.2 (0.047)	30.5 (1.200)

*Tolerance ± 0.8

NOTE: This style is only available in 2, 3 & 4 chip assemblies only millimeters (inches)

Style	T max
CH42/52/62/72/77/87/92	7.4 (0.291)
CH43/53/63/73/78/83/93	11.1 (0.437)
CH44/54/64/74/79/89/94	14.8 (0.583)

HORIZONTALLY MOUNTED DUAL-IN-LINE PRODUCT

Part Number format (CHxxxxxxxx0A0)

Typical Part Number CH615C106MA30A0

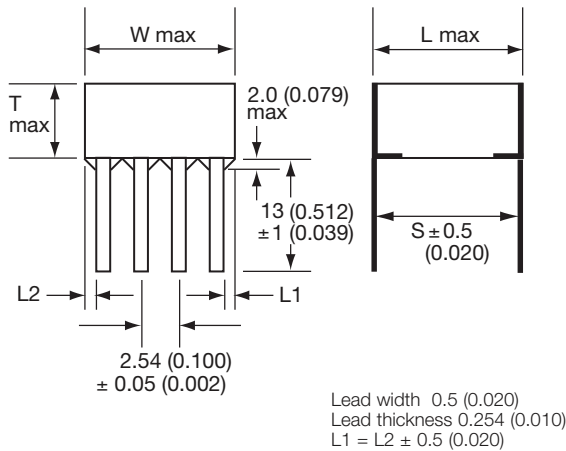

DIMENSIONS

millimeters (inches)

Style	L (max)	W (max)	S (nom)	No. of Leads per side
CH41-44	9.2 (0.362)	8.7 (0.342)	8.2 (0.322)	3
CH51-54	10.7 (0.421)	10.7 (0.421)	10.2 (0.400)	4
CH61-64	14.9 (0.586)	13.6 (0.535)	14.0 (0.551)	5
CH71-74	16.8 (0.661)	21.6 (0.850)	15.2 (0.600)	7
CH76-79	21.6 (0.850)	16.6 (0.653)	20.3* (0.800)	6
CH81-84	12.0 (0.472)	38.2 (1.503)	10.2 (0.400)	14
CH86-89	18.9 (0.744)	38.2 (1.503)	15.2 (0.600)	14
CH91-94	24.0 (0.944)	40.6 (1.598)	20.3* (0.800)	14

*Tolerance ± 0.8 (0.031)

millimeters (inches)

Style	T max
CH41/51/61/71/76/81/86/91	3.8 (0.150)
CH42/52/62/72/77/82/87/92	7.4 (0.291)
CH43/53/63/73/78/83/88/93	11.1 (0.437)
CH44/54/64/74/79/84/89/94	14.8 (0.583)

HOW TO ORDER

CH	52	5	C	106	M	A	3	0	A	0
Style Code (see product section)	Size Code	Voltage Code	Dielectric Code	Capacitance Code	Capacitance Tolerance	Specification Code	Finish Code	Lead Dia. Code	Lead Space Code	Lead Style Code
	5 = 50V 1 = 100V 2 = 200V 7 = 500V	A = C0G C = X7R	(2 significant digits + no. of zeros) eg. 105 = 1 µF 106 = 10 µF 107 = 100 µF	C0G: J = ±5% K = ±10% M = ±20% X7R: K = ±10% M = ±20% P = +100, -0%	A = Non-customized	3 = Uncoated 8 = Coated (classified as uninsulated)	0 = Standard	A = Standard	0 = Straight dual in line 4 = 4 Terminal	

Note: See page 122 for How to Order BS9100 parts



SMPS Capacitors (CH Style)



Chip Assemblies

HORIZONTALLY MOUNTED 'L' LEAD SMT PRODUCT

Part Number format (CHxxxxxxxxxx0A7)

Typical Part Number CH411C275KA30A7

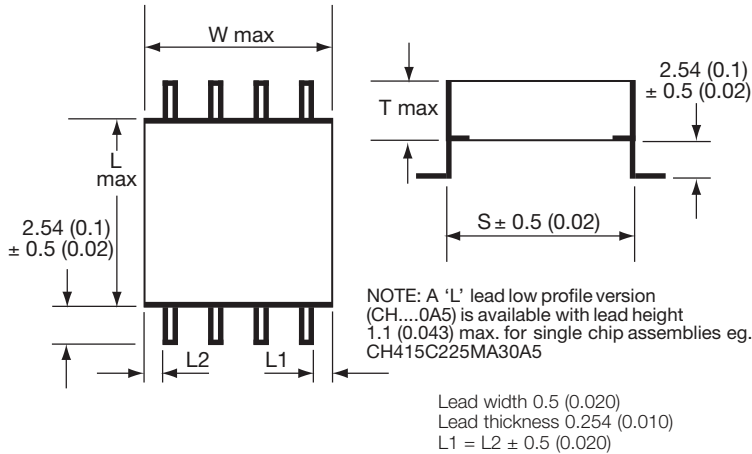

DIMENSIONS

millimeters (inches)

Style	L (max)	W (max)	S (nom)	No. of Leads per side
CH41-44	9.2 (0.362)	8.7 (0.342)	8.2 (0.322)	3
CH51-54	10.7 (0.421)	10.7 (0.421)	10.2 (0.400)	4
CH61-64	14.9 (0.586)	13.6 (0.535)	14.0 (0.551)	5
CH71-74	16.8 (0.661)	21.6 (0.850)	15.2 (0.600)	7
CH76-79	21.6 (0.850)	16.6 (0.653)	20.3* (0.800)	6
CH81-84	12.0 (0.472)	38.2 (1.503)	10.2 (0.400)	14
CH86-89	18.9 (0.744)	38.2 (1.503)	15.2 (0.600)	14
CH91-94	24.0 (0.944)	40.6 (1.598)	20.3* (0.800)	14

*Tolerance ± 0.8 (0.031)

millimeters (inches)

Style	T max
CH41/51/61/71/76/81/86/91	3.8 (0.150)
CH42/52/62/72/77/82/87/92	7.4 (0.291)
CH43/53/63/73/78/83/88/93	11.1 (0.437)
CH44/54/64/74/79/84/89/94	14.8 (0.583)

HORIZONTALLY MOUNTED 'J' LEAD SMT PRODUCT

Part Number format (CHxxxxxxxxxx0A8)

Typical Part Number CH411C275KA30A8

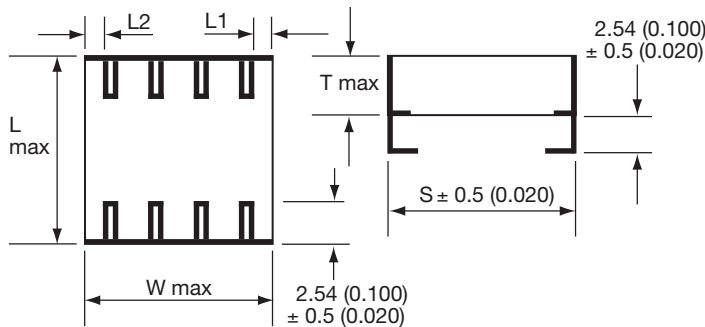

DIMENSIONS

millimeters (inches)

Style	L (max)	W (max)	S (nom)	No. of Leads per side
CH41-44	9.2 (0.362)	8.7 (0.342)	8.2 (0.322)	3
CH51-54	10.7 (0.421)	10.7 (0.421)	10.2 (0.400)	4
CH61-64	14.9 (0.586)	13.6 (0.535)	14.0 (0.551)	5
CH71-74	16.8 (0.661)	21.6 (0.850)	15.2 (0.600)	7
CH76-79	21.6 (0.850)	16.6 (0.653)	20.3* (0.800)	6
CH81-84	12.0 (0.472)	38.2 (1.503)	10.2 (0.400)	14
CH86-89	18.9 (0.744)	38.2 (1.503)	15.2 (0.600)	14
CH91-94	24.0 (0.944)	40.6 (1.598)	20.3* (0.800)	14

*Tolerance ± 0.8 (0.031)

millimeters (inches)

Style	T max
CH41/51/61/71/76/81/86/91	3.8 (0.150)
CH42/52/62/72/77/82/87/92	7.4 (0.291)
CH43/53/63/73/78/83/88/93	11.1 (0.437)
CH44/54/64/74/79/84/89/94	14.8 (0.583)

HOW TO ORDER

CH	52	5	C	106	M	A	3	0	A	7
Style Code	Size Code	Voltage Code	Dielectric Code	Capacitance Code	Capacitance Tolerance	Specification Code	Finish Code	Lead Dia. Code	Lead Space Code	Lead Style Code
(see product section)		5 = 50V 1 = 100V 2 = 200V 7 = 500V	A = COG C = X7R	(2 significant digits + no. of zeros) eg. 105 = 1 µF 106 = 10 µF 107 = 100 µF	COG: J = ±5% K = ±10% M = ±20% X7R: K = ±10% M = ±20% P = +100, -0%	A = Non-customized	3 = Uncoated 8 = Coated (classified as uninsulated)	0 = Standard	A = Standard	3 = Low profile 'J' (single chip) 5 = Low profile 'L' (single chip) 7 = 'L' Dual in line 8 = 'J' Dual in line

Note: See page 122 for How to Order BS9100 parts



SMPS Molded Radial MLC Capacitors



SXP Style for High Temperature Applications up to 200°C

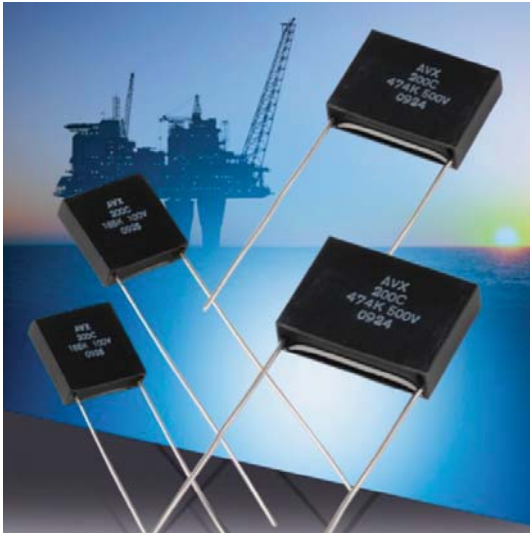

SXP-style, encapsulated radial leaded MLC capacitors are ideally suited for high temperature applications up to 200°C. This product is intended for downhole oil exploration, including logging while drilling, geophysical probes, as well as space, aerospace and hybrid automotive applications. This product supplements the SMX family of capacitors and offers mechanical protection to the ceramic element in extreme harsh environment. The high temperature solder utilized in the construction of SXP-style parts assures reliable operation in high temperature and rugged environments. The SXP-style capacitors are ideally suited for applications as DC filters in high power, high frequency motor drives, high pulsed-current circuitry, as well as standard electronic equipment designed for high temperature applications.

SXP-style, switch mode power supply capacitors are characterized with excellent performance. The main benefits of SXP product include:

- Low ESR, low ESL
- Low DC leakage
- Excellent high frequency performance

HOW TO ORDER

SXP	3	1	C	104	M	A	A
AVX Style	Size See Dimensions chart	Voltage Code 50V = 5 100V = 1 200V = 2 500V = 7 1000V = A	Temperature Coefficient C0G = A X7R/X9U = C	Capacitance Code (2 significant digits + number of zeros) 100 pF = 101 22,000 pF = 223 1µF = 105	Capacitance Tolerance C0G: J = ±5% K = ±10% M = ±20% X7R: J = ±5% K = ±10% M = ±20% Z = +80%, -20%	Test Level A = Standard	Leads A = Standard Sn/Pb (min. 5% Pb)
					Tighter tolerances available upon request		

ELECTRICAL SPECIFICATIONS

Temperature Coefficient

C0G: A Temperature Coefficient 0 ±30 ppm/°C, -55° to +200°C
 X7R/X9U: C Temperature Coefficient ±15%, -55°C to +125°C
 +15% - 56%, -55°C to +200°C

Capacitance Test (MIL-STD-202 Method 305)

25°C, 1.0±0.2 Vrms (open circuit voltage) at 1KHz

Dissipation Factor 25°C

C0G: 0.15% Max @ 25°C, 1.0±0.2 Vrms (open circuit voltage) at 1KHz
 X7R/X9U: 2.5% Max @ 25°C, 1.0±0.2 Vrms (open circuit voltage) at 1KHz

Insulation Resistance 25°C (MIL-STD-202 Method 302)

100K MΩ or 1000 MΩ-µF, whichever is less.

Insulation Resistance 125°C (MIL-STD-202 Method 302)

10K MΩ or 100 MΩ-µF, whichever is less.

Insulation Resistance 200°C (MIL-STD-202 Method 302)

100 MΩ or 1 MΩ -µF, whichever is less.

Dielectric Withstanding Voltage 25°C (Flash Test)

250% rated voltage for 5 seconds with 50 mA max charging current. (150% for 500 VDC and 1000 VDC)

SMPS Molded Radial MLC Capacitors



SXP Style for High Temperature Applications up to 200°C

STYLE

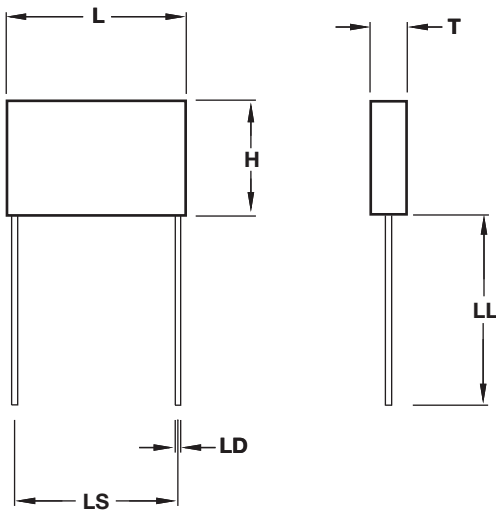

DIMENSIONS

millimeters (inches)

AVX Style	Length (L) ±0.25 (±0.010)	Height (H) ±0.25 (±0.010)	Thickness (T) ±0.25 (±0.010)	Lead Spacing ±0.76 (±0.030)	LD ±0.05 (±0.002)
SXP1	8.90 (0.350)	8.90 (0.350)	5.18 (0.200)	6.35 (0.250)	0.64 (0.025)
SXP2	11.4 (0.450)	11.4 (0.450)	5.08 (0.200)	8.38 (0.330)	0.64 (0.025)
SXP3	12.7 (0.500)	12.7 (0.500)	5.08 (0.200)	10.2 (0.402)	0.64 (0.025)
SXP4	22.4 (0.880)	16.3 (0.641)	5.84 (0.230)	19.8 (0.780)	0.64 (0.025)

CAPACITANCE RANGE

C0G

Style	50V	100V	200V	500V	1000V
SXP1 (MIN)	1000pF	1000pF	1000pF	100pF	100pF
(MAX)	.047μF	.027μF	8200pF	4700pF	2200pF
SXP2 (MIN)	.01μF	1000pF	1000pF	100pF	100pF
(MAX)	.10μF	.056μF	.018μF	8200pF	4700pF
SXP3 (MIN)	.01μF	1000pF	1000pF	1000pF	1000pF
(MAX)	.15μF	.068μF	.022μF	.012μF	6800pF
SXP4 (MIN)	.01μF	.01μF	1000pF	1000pF	1000pF
(MAX)	.39μF	.22μF	.068μF	.033μF	.018μF

X7R

Style	50V	100V	200V	500V	1000V
SXP1 (MIN)	.1μF	.01μF	.01μF	.01μF	.01μF
(MAX)	1.2μF	.68μF	.27μF	.12μF	.033μF
SXP2 (MIN)	.1μF	.1μF	.01μF	.01μF	.01μF
(MAX)	2.2μF	1.2μF	.56μF	.22μF	.068μF
SXP3 (MIN)	.01μF	.1μF	.01μF	.01μF	.01μF
(MAX)	3.3μF	1.8μF	.82μF	.33μF	.10μF
SXP4 (MIN)	1μF	.1μF	.1μF	.01μF	.01μF
(MAX)	10μF	5.6μF	2.2μF	1.0μF	.27μF

TurboCap™

High-CV SMPS Capacitors



ELECTRICAL SPECIFICATIONS

Temperature Coefficient

Temperature Coefficient ±15%, -55° to +125°C

Capacitance Test (MIL-STD-202 Method 305)

25°C, 1.0±0.2 Vrms (open circuit voltage) at 1KHz

Dissipation Factor 25°C

2.5% Max @ 25°C, 1.0±0.2 Vrms (open circuit voltage) at 1KHz

Insulation Resistance 25°C (MIL-STD-202 Method 302)

500 MΩ-μF, whichever is less.

Insulation Resistance 125°C (MIL-STD-202 Method 302)

50 MΩ-μF, whichever is less.

Dielectric Withstanding Voltage 25°C (Flash Test)

250% rated voltage for 5 seconds with 50 mA max charging current.

Life Test (1000 hrs)

X7R: 150% rated voltage at +125°C.

Moisture Resistance (MIL-STD-202 Method 106)

Ten cycles with no voltage applied.

Thermal Shock (MIL-STD-202 Method 107, Condition A)

Immersion Cycling (MIL-STD-202 Method 104, Condition B)

Resistance To Solder Heat (MIL-STD-202, Method 210, Condition B, for 20 seconds)

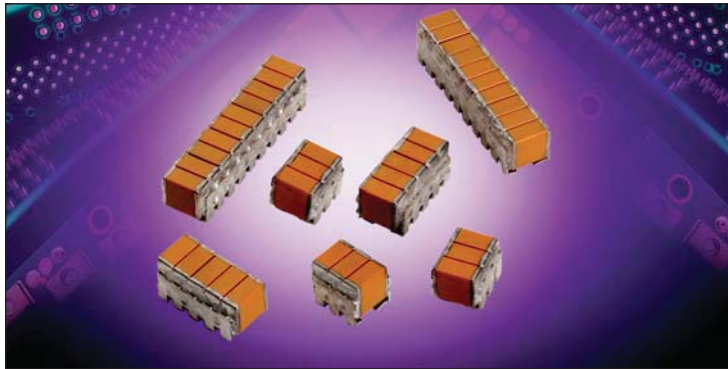

Typical ESR Performance (Ω)

	27μF	47μF	100μF
ESR @ 10KHz	0.007	0.004	0.003
ESR @ 50KHz	0.003	0.002	0.0015
ESR @ 100KHz	0.002	0.0015	0.001

HOW TO ORDER

AVX Styles: ST12 and ST20

ST12	5	C	186	M	A	N	03
AVX Style	Voltage	Temperature Coefficient	Capacitance Code (2 significant digits + no. of zeros)	Capacitance Tolerance	Test Level	Termination	Number of Leads Per Side
ST12	25V = 3 50V = 5 100V = 1	X7R = C	1 μF = 105 10 μF = 106 100 μF = 107	M = ±20%	A = Standard	N = Straight Lead J = Leads formed in L = Leads formed out	03 = 3 05 = 5 10 = 10

CAPACITANCE (μF)

Cap (μF)	ST12		ST20			
	Voltage					
	50V	100V	25V	50V	100V	500V
.82						
1.3						
2.7						
8.2		...03				
12		...05				
14					...03	
18	...03					
22		...10			...05	
27	...05			...03	...10	
47				...05	...10	
50	...10					
68			...03			
100			...05	...10		
220			...10			

Development

Numbers inside shaded areas refer to the number of leads per side (the last two digits of the part number).



TurboCap™

High-CV SMPS Capacitors

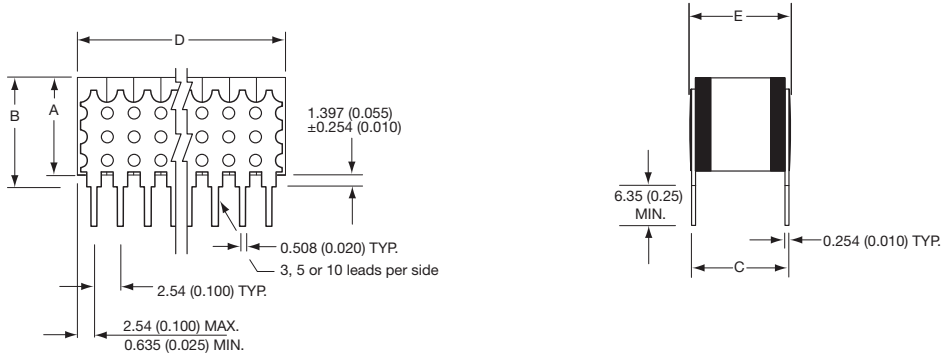

“N” STYLE LEADS

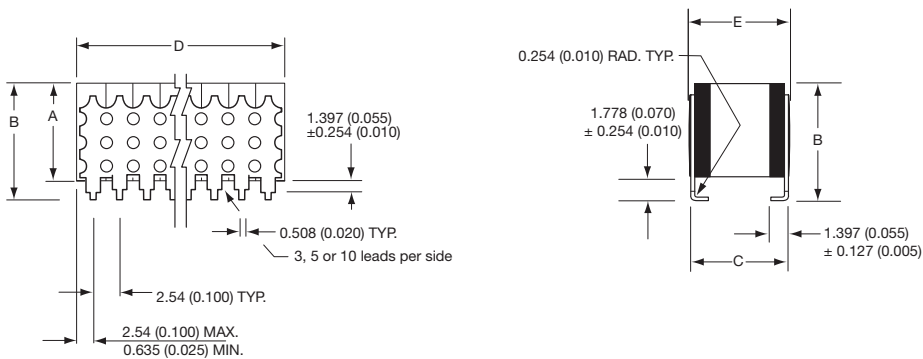

“J” STYLE LEADS

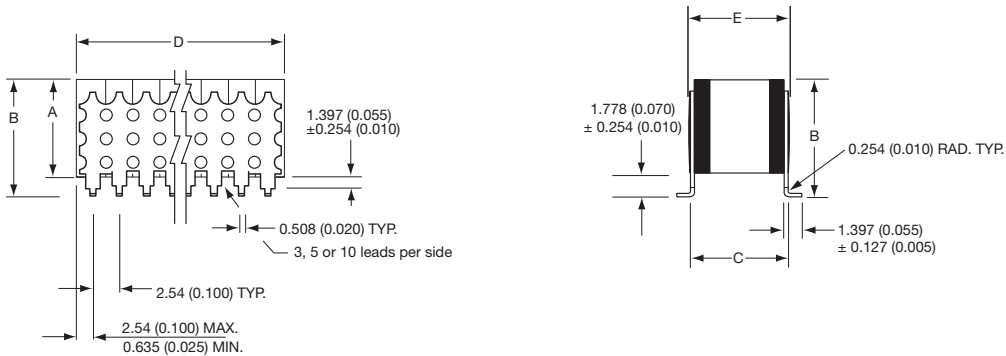

“L” STYLE LEADS

DIMENSIONS

millimeters (inches)

Style	A (max.)	B (max.)*	C ± 0.635 (± 0.025)	D ± 1.27 (± 0.050)	E (max.)	Lead Style	No. of Leads Per Side
ST125C***M*N03	3.56 (0.140)	5.21 (0.205)	5.08 (0.200)	9.53 (0.375)	6.35 (0.250)	N	03
ST125C***M*N05	3.56 (0.140)	5.21 (0.205)	5.08 (0.200)	14.61 (0.575)	6.35 (0.250)	N	05
ST125C***M*N10	3.56 (0.140)	5.21 (0.205)	5.08 (0.200)	26.67 (1.050)	6.35 (0.250)	N	10
ST205C***M*N03	5.59 (0.220)	7.24 (0.285)	6.35 (0.250)	8.26 (0.325)	7.62 (0.300)	N	03
ST205C***M*N05	5.59 (0.220)	7.24 (0.285)	6.35 (0.250)	13.34 (0.525)	7.62 (0.300)	N	05
ST205C***M*N10	5.59 (0.220)	7.24 (0.285)	6.35 (0.250)	26.04 (1.025)	7.62 (0.300)	N	10

*The “B” dimension is defined for the “N” Style leads. The “L” and “J” Style Leads are 0.381 (0.015) longer. The ST12 will be 5.89 (0.220), the ST20 will be 7.62 (0.300).



RoHS Compliant TurboCap™



High-CV SMPS Capacitors

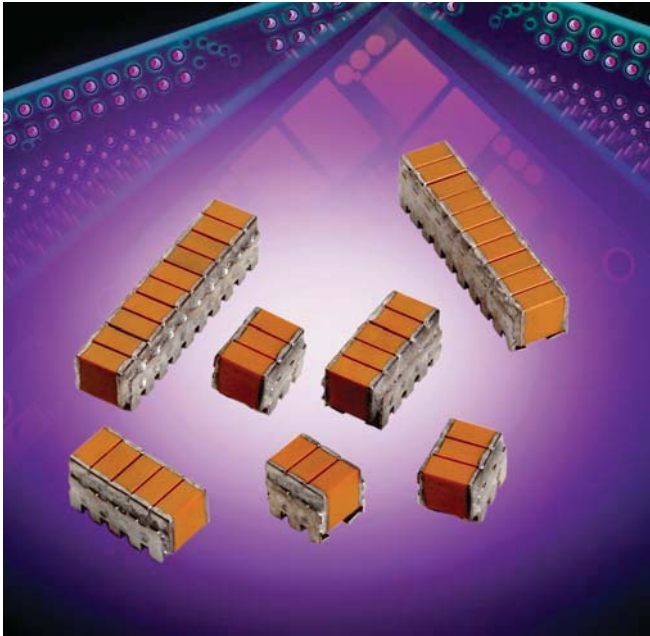

The TurboCap™, MLC capacitors from AVX Corporation are characterized with very high capacitance in a small volume. By vertical stacking of the ceramic elements, the footprint required for mounting the capacitors is greatly reduced. TurboCaps™ are ideally suited as filters in the input and output stages of switch mode power supplies (SMPS). With their ultra-low ESR, these capacitors are designed to handle high ripple current at high frequencies and high power levels. The DIP leads in either thru-hole or surface mount configurations offer superior stress relief to the ceramic elements. The leads effectively decouple the parts from the board and minimize thermally or mechanically induced stresses encountered during assembly, temperature cycling or other environmental conditions.

TYPICAL APPLICATION OF TURBOCAP™ SMPS CAPACITORS FOR INPUT AND OUTPUT FILTERS IN DC/DC CONVERTERS

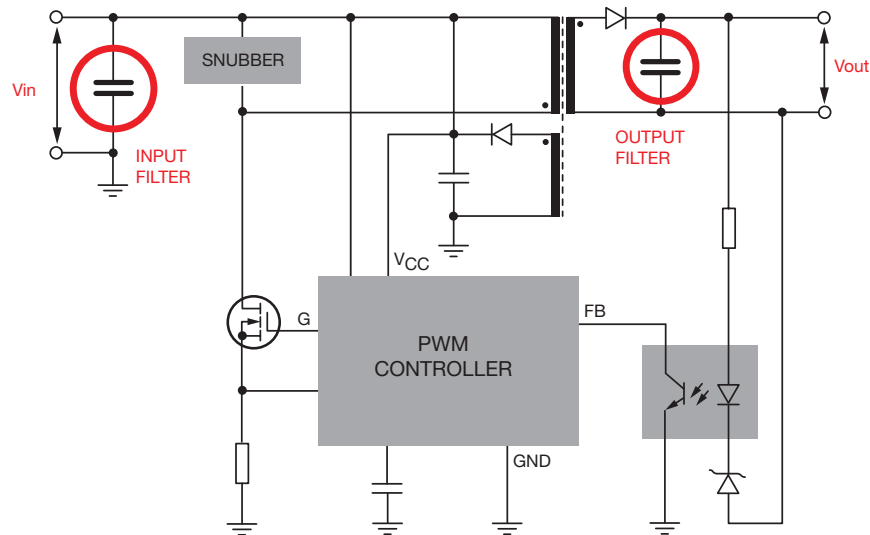

RoHS Compliant TurboCap™



High-CV SMPS Capacitors

ELECTRICAL SPECIFICATIONS

Temperature Coefficient

Temperature Coefficient ±15%, -55° to +125°C

Capacitance Test (MIL-STD-202 Method 305)

25°C, 1.0±0.2 Vrms (open circuit voltage) at 1KHz

Dissipation Factor 25°C

2.5% Max @ 25°C, 1.0±0.2 Vrms (open circuit voltage) at 1KHz

Insulation Resistance 25°C (MIL-STD-202 Method 302)

500 MΩ-μF, whichever is less.

Insulation Resistance 125°C (MIL-STD-202 Method 302)

50 MΩ-μF, whichever is less.

Dielectric Withstanding Voltage 25°C (Flash Test)

250% rated voltage for 5 seconds with 50 mA max charging current.

Life Test (1000 hrs)

X7R: 150% rated voltage at +125°C.

Moisture Resistance (MIL-STD-202 Method 106)

Ten cycles with no voltage applied.

Thermal Shock (MIL-STD-202 Method 107, Condition A)

Immersion Cycling (MIL-STD-202 Method 104, Condition B)

Resistance To Solder Heat (MIL-STD-202, Method 210,

Condition B, for 20 seconds)

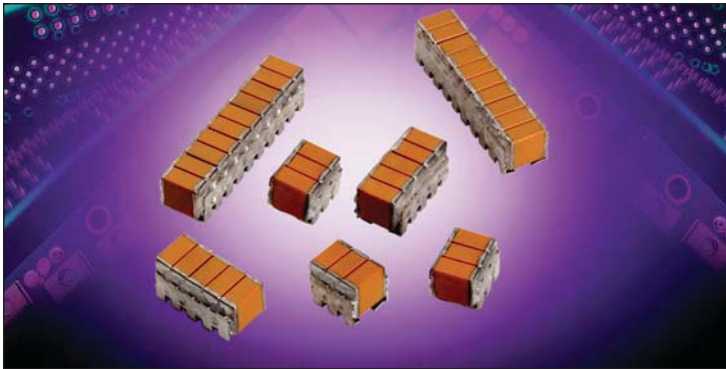

Typical ESR Performance (Ω)

	27μF	47μF	100μF
ESR @ 10KHz	0.007	0.004	0.003
ESR @ 50KHz	0.003	0.002	0.0015
ESR @ 100KHz	0.002	0.0015	0.001

HOW TO ORDER

AVX Styles: RT12 and RT20

RT12	5	C	186	M	A	N	03
AVX Style	Voltage	Temperature Coefficient	Capacitance Code (2 significant digits + no. of zeros)	Capacitance Tolerance	Test Level	Termination	Number of Leads Per Side
RT12	25V = 3 50V = 5 100V = 1	X7R = C	1 μF = 105 10 μF = 106 100 μF = 107	M = ±20%	A = Standard	N = Straight Lead J = Leads formed in L = Leads formed out	03 = 3 05 = 5 10 = 10

CAPACITANCE (μF)

Cap (μF)	RT12		RT20		
	50V	100V	Voltage		
			25V	50V	100V
.82					
1.3					
2.7					
8.2		...03			
12		...05			
14					...03
18	...03				
22		...10			...05
27	...05			...03	
47				...05	...10
50	...10				
68			...03		
100			...05	...10	
220			...10		

RoHS Compliant TurboCap™



High-CV SMPS Capacitors

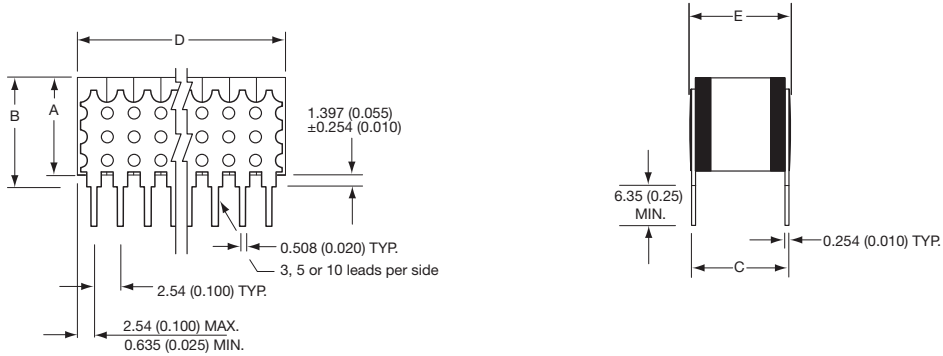

“N” STYLE LEADS

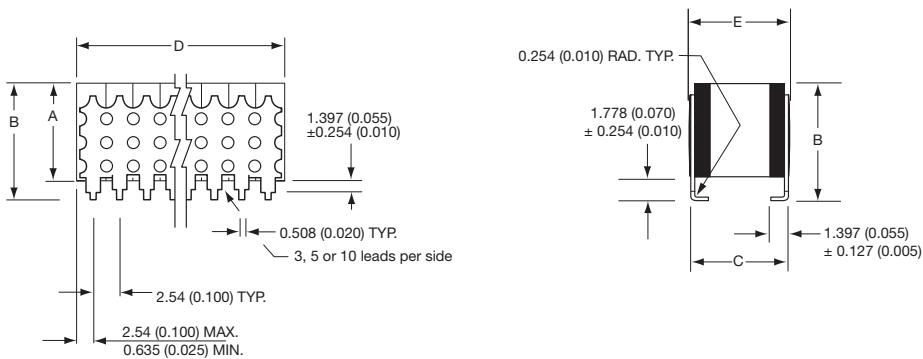

“J” STYLE LEADS

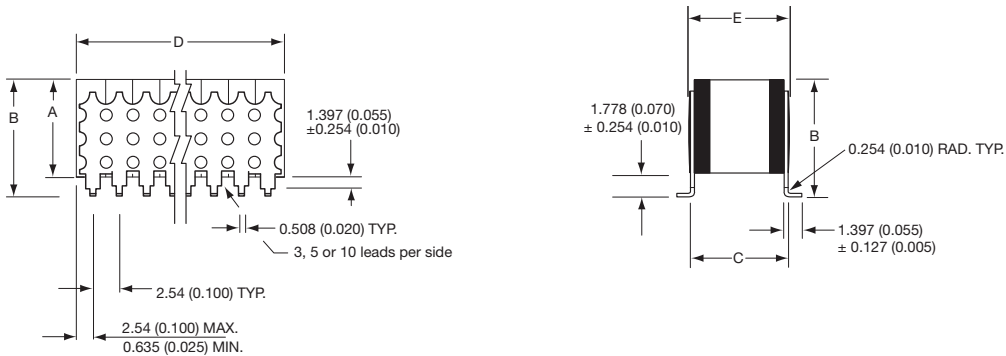

“L” STYLE LEADS

DIMENSIONS

millimeters (inches)

Style	A (max.)	B (max.)*	C ± 0.635 (± 0.025)	D (max.)	E (max.)	Lead Style	No. of Leads Per Side
RT125C***M*N03	3.56 (0.140)	5.21 (0.205)	5.08 (0.200)	10.8 (0.425)	6.35 (0.250)	N	03
RT125C***M*N05	3.56 (0.140)	5.21 (0.205)	5.08 (0.200)	15.9 (0.625)	6.35 (0.250)	N	05
RT125C***M*N10	3.56 (0.140)	5.21 (0.205)	5.08 (0.200)	27.9 (1.100)	6.35 (0.250)	N	10
RT205C***M*N03	5.59 (0.220)	7.24 (0.285)	6.35 (0.250)	9.50 (0.375)	7.62 (0.300)	N	03
RT205C***M*N05	5.59 (0.220)	7.24 (0.285)	6.35 (0.250)	14.6 (0.575)	7.62 (0.300)	N	05
RT205C***M*N10	5.59 (0.220)	7.24 (0.285)	6.35 (0.250)	27.3 (1.075)	7.62 (0.300)	N	10

*The “B” dimension is defined for the “N” Style leads. The “L” and “J” Style Leads are 0.381 (0.015) longer. The ST12 will be 5.89 (0.220), the ST20 will be 7.62 (0.300).



MH Ceramic Capacitor



Lead Free Ceramic Capacitor in Molded SM Leadframe



AVX are pleased to introduce the MH range of multi layer ceramic capacitors. The MH components are surface mount molded parts with a multi layer ceramic insert.

MH capacitors combine the ceramic attributes of very low ESR, non polar construction, excellent high frequency behavior, excellent voltage stress capabilities and wide temperature range; with the enhanced mechanical protection of a molded case.

The MH range provides a lead free solution to customers who have previously been unable to use large case ceramic capacitors because of mechanical stressing concerns.

HOW TO ORDER

MH	V	1	1	C	225	M	A	T	2	A
MH Series	Case Size see table below	MLCC Count	Voltage 3 = 25V 5 = 50V 1 = 100V	Dielectric C = X7R	Capacitance Code (In pF) 2 Sig. Digits + Number of Zeros	Capacitance Tolerance K = ±10% M = ±20%	Failure Rate A = Not Applicable	Terminations T = Tin Plated	Packaging 2 = 7" Reel 4 = 13" Reel 6 = Waffle Pack	Special Code A = Std. Product

MH X7R TARGET RANGE

	Cap μ F	25V	50V	100V
105	1.0			
125	1.2			
155	1.5			
185	1.8			
225	2.2			
275	2.7			
335	3.3			
395	3.9			
475	4.7			
565	5.6			
685	6.8			
825	8.2			
106	10			
126	12			
156	15			
186	18			
226	22			
276	27			
336	33			
396	39			
476	47			

PACKAGING

7" Reels	400
13" Reels	1500
Waffle Pack	108

CASE DIMENSIONS: millimeters (inches)

Code	EIA Code	L±0.20 (0.008)	W+0.20 (0.008) -0.10 (0.004)	H+0.20 (0.008) -0.10 (0.004)
V	7361-38	7.30 (0.287)	6.10 (0.240)	3.45±0.30 (0.136±0.012)

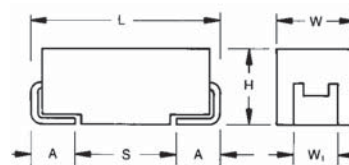

NOTICE: Specifications are subject to change without notice. Contact your nearest AVX Sales Office for the latest specifications. All statements, information and data given herein are believed to be accurate and reliable, but are presented without guarantee, warranty, or responsibility of any kind, expressed or implied. Statements or suggestions concerning possible use of our products are made without representation or warranty that any such use is free of patent infringement and are not recommendations to infringe any patent. The user should not assume that all safety measures are indicated or that other measures may not be required. Specifications are typical and may not apply to all applications.



TS 16949, ISO 14001
Certified Manufacture



SMPS Capacitors (RH Style)



RH - Surface Mount 'J' Lead Range

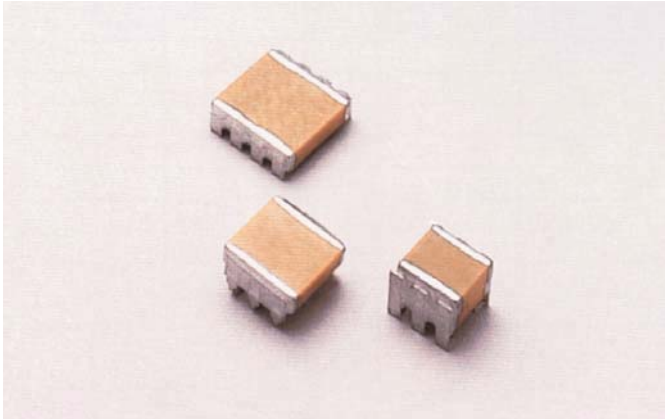

0.047 μ F to 47.0 μ F Low ESR/ESL
 25V to 500 VDC X7R Dielectric
 -55°C to +125°C

This range of uncoated MLC capacitors are processed for input and output filter capacitors in high frequency DC-DC convertor applications above 10 Watts e.g. telecomms and instrumentation, where high volume and low cost is required. These products are available in surface mount 'J' leaded versions and can be supplied in bulk and tape/reel packaging.

ELECTRICAL SPECIFICATIONS

Temperature Coefficient CECC 30 000, (4.24.1)
 X7R: C Temperature Characteristic - \pm 15%, -55°C to +125°C

Capacitance Test
 Measured at 1 VRMS max at 1KHz

Dissipation Factor 25°C
 2.5% max at 1KHz, 1 VRMS max

Insulation Resistance 25°C
 100K megohms or 1000 megohms- μ F, whichever is less

Dielectric Withstanding Voltage 25°C (Flash Test)
 250% rated voltage for 5 seconds with 50 mA max charging current. (500 Volt units @ 150% rated voltage)

Life Test (1000 hrs) CECC 30 000 (4.23)
 200% rated voltage at +125°C.
 (500 Volt units @ 120% rated voltage)

Thermal Shock IEC 68.2.14
 -55°C to +125°C, 5 cycles

Resistance to Solder Heat IEC 68.2.20

Typical ESR (m Ω) 3 μ F, 100V X7R	
ESR @ 100KHz	17
ESR @ 500KHz	12
ESR @ 1MHz	14

DIMENSIONS

millimeters (inches)

Style	L max	W max	H max	S \pm 0.1 (\pm 0.004)	h	No. of leads per side
RH21	7.62 (0.300)	5.40 (0.213)	4.60 (0.181)	2.50 (0.098)	1.50 \pm 0.30 (0.059 \pm 0.012)	2
RH22	7.62 (0.300)	5.40 (0.213)	7.50 (0.295)	2.50 (0.098)	1.50 \pm 0.30 (0.059 \pm 0.012)	2
RH31	7.62 (0.300)	7.00 (0.270)	5.08 (0.200)	5.08 (0.200)	1.78 \pm 0.25 (0.070 \pm 0.010)	3
RH32	7.62 (0.300)	7.00 (0.270)	8.13 (0.320)	5.08 (0.200)	1.78 \pm 0.25 (0.070 \pm 0.010)	3
RH41	9.20 (0.362)	8.70 (0.342)	4.90 (0.192)	5.08 (0.200)	1.60 \pm 0.10 (0.062 \pm 0.004)	3
RH42	9.20 (0.362)	8.70 (0.342)	8.20 (0.323)	5.08 (0.200)	1.60 \pm 0.10 (0.062 \pm 0.004)	3
RH51	10.7 (0.421)	10.7 (0.421)	4.90 (0.192)	7.62 (0.300)	1.60 \pm 0.10 (0.062 \pm 0.004)	4
RH52	10.7 (0.421)	10.7 (0.421)	8.20 (0.323)	7.62 (0.300)	1.60 \pm 0.10 (0.062 \pm 0.004)	4
RH61	14.9 (0.586)	13.6 (0.535)	4.90 (0.192)	10.2 (0.400)	1.60 \pm 0.10 (0.062 \pm 0.004)	5
RH62	14.9 (0.586)	13.6 (0.535)	8.20 (0.323)	10.2 (0.400)	1.60 \pm 0.10 (0.062 \pm 0.004)	5

DIMENSIONS millimeters (inches)

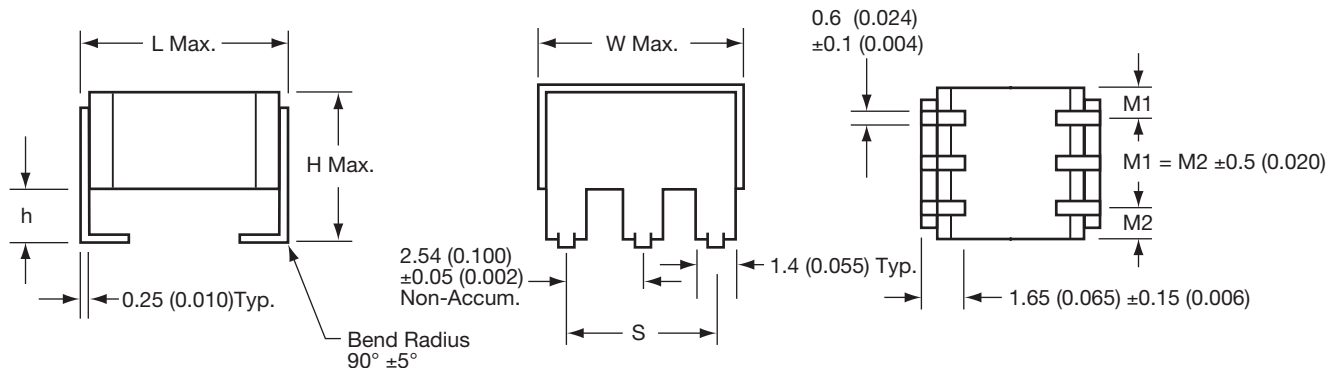

SMPS Capacitors (RH Style)



RH - Surface Mount 'J' Lead Range

X7R STABLE DIELECTRIC

Cap μ F	RH21/RH22 Style					RH31/RH32 Style					RH41/RH42 Style				RH51/RH52 Style				RH61/RH62 Style			
	25	50	100	200	500	50	100	200	500	50	100	200	500	50	100	200	500	50	100	200	500	
0.047																						
0.056																						
0.068									RH31													
0.082																						
0.1																						
0.12																						
0.15									RH32				RH41									
0.18																						
0.22																						
0.27									RH31				RH42									
0.33																						
0.39																						
0.47													RH41									
0.56									RH32													
0.68																						
0.78																						
0.82																						
1									RH31													
1.2																						
1.5									RH31													
1.8													RH41									
2.2																						
2.7																						
3																						
3.3																						
3.9																						
4.4																						
4.7																						
5.6																						
6.8																						
8.2																						
10																						
12																						
15																						
18																						
22																						
27																						
33																						
39																						
47																						

For availability of further parts in the RH21/RH22 Series, contact manufacturing.

PACKAGING

Style	Qty/Reel 13"	Max. Qty/Waffle Pack
RH21	800	270
RH22	500	270
RH31	800	108
RH32	500	108
RH41	800	108
RH42	see note	100
RH51	750	88
RH52	see note	88
RH61	500	42
RH62	see note	42

Note: T&R is not yet available. Contact manufacturing for further information as this will be available in the future.

HOW TO ORDER

RH	31	5	C	225	M	A	3	0	A	3
Style Code (see table above)	Size Code	Voltage Code 3 = 25V 5 = 50V 1 = 100V 2 = 200V 7 = 500V	Dielectric Code C = X7R	Capacitance Code (2 significant digits + no. of zeros) eg. 105 = 1 μ F 104 = 0.1 μ F	Capacitance Tolerance K = \pm 10% M = \pm 20%	Specification Code A = Non customized	Package Code 3 = Waffle Pack A = Tape & Reel	Lead Dia. Code 0 = Standard R = RoHS Compliant	Lead Space Code A = Standard	Lead Style Code 3 = 'J' Lead



SMPS Capacitors

Custom Lead Configurations

For the requirements that cannot be satisfied by standard SMPS style products (SM0-style or SM9-style), AVX offers leading edge solutions in custom lead configuration and custom packaging. Custom lead configurations offering optimum packaging, high current handling capabilities and stress relief mounting options are all possible with AVX. The custom solutions provided by AVX maintain high reliability of stacked capacitor product originally developed by AVX and historically recognized as the highest reliability product in the market. Custom packaging options provide solutions that eliminate reliability concerns in the next level assembly. These custom options provide the following benefits:

- eliminate soldering requirements altogether by providing means of electrical/mechanical connection to the circuit
- provide options for remote soldering away from large ceramic capacitor body and eliminating the risk of thermal shock (refer to photograph with soft, insulated leads soldered to the stacked capacitor using high melting point SN10 solder)

Many other innovations are available from AVX Olean Advanced Products. Let them apply these ideas to your application specific requirements. Please consult with AVX's Application Engineering staff for a custom solution that will meet demands of your program requirements.

CUSTOM LEAD CONFIGURATIONS...

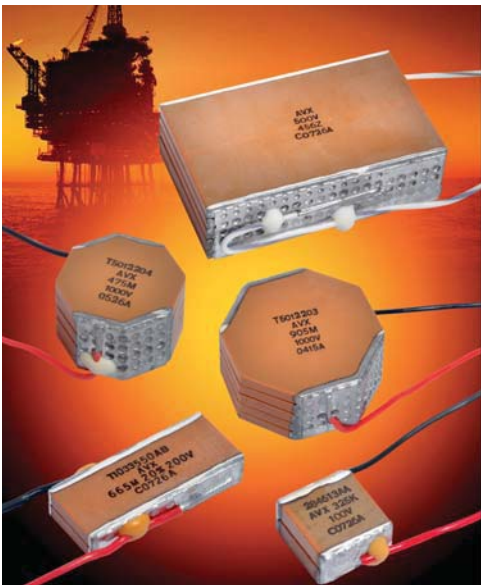

CUSTOM PACKAGING...



SMPS Capacitors

Assembly Guidelines

Reliability

AVX has been involved in numerous military and customer High Reliability programs for over 40 years.

Reliability [% Failure Rate (FR%) or Mean Time Between Failure (MTBF)] is based on the number of failures and the cumulative test hours expanded by test versus use acceleration factors. The acceleration factors are calculated according to the following relationships:

$$\text{Temperature Acceleration} = 10^{\left(\frac{T_T - T_U}{25}\right)}$$

Where:
 T_T = test temp. (°C)
 T_U = use temp. (°C)

$$\text{Voltage Acceleration} = \left(\frac{V_T}{V_U}\right)^3$$

Where:
 V_T = test voltage
 V_U = use voltage

Military Reliability levels are usually expressed in terms of rated conditions versus test conditions (generally 125°C and 2X WVDC). If actual conditions are less than rated, the reliability levels will improve significantly over rated and can be calculated by use of the above relationship for determining accelerated test hours. For example, if the actual use conditions were 75°C and 1/2 WVDC rating for a 125°C rated part, the acceleration factors are 64X for voltage and 100X for temperature. Reliabilities based on current testing can be obtained by contacting AVX.

General Processing Guidelines

Soldering

The SM styles capacitors are generally quite large relative to other types of MLC capacitors. As a result of the size, precautions must be taken before subjecting the parts to any soldering operation in order to prevent thermal shock. Preheat prior to soldering is essential. The heating rate of the SupraCap® ceramic bodies during preheat must not exceed 4°C/second. The preheat temperature must be within 50°C of the peak temperature reached by the ceramic bodies, adjacent to lead material, through the soldering process. The leads are attached to the chip stack with 10 / 88 / 2 (Sn / Pb / Ag, Solidus 268°C, Liquidus 290°C).

Vibration Specifications*

Due to the weight of the SupraCap® and the size and strength of the lead frame used, when the SupraCap® is to be used in an application where it will undergo high frequency vibration, we strongly recommend using our potted SM9 styles SupraCap®.

If other DIP styles SupraCap® are to be used in a high frequency vibration environment, the SupraCap® should be supported in some way to prevent oscillation of the capacitor assembly which will result in lead breakage. If “strapping” the SupraCap® to the board is the chosen method of support, care should be taken not to chip the ceramic or apply undue pressure so that cracking of the ceramic results.

If bonding the SupraCap® to the board with adhesive, consideration of the CTE (coefficient of thermal expansion) is necessary. A mismatch between the CTE of the ceramic and adhesive can cause the ceramic to crack during temperature cycles.

Processing Guidelines*

There are practical size limitations for MLCs which prohibit reliable direct mounting of chip capacitors larger than 2225 (.22" x .25") to a substrate. These large chips are subject to thermal shock cracking and thermal cycling solder joint fatigue. Even 1812 (.18" x .12") and 2225 chip capacitors will have solder joint failures due to mechanical fatigue after ≈ 1500 thermal cycles from 0 to 85°C on FR4 and ≈ 3000 cycles on alumina from -55 to 125°C. This is due to differences in the Coefficient of Thermal Expansion (CTE) between MLCs and substrate materials used in hybrids and surface mount assemblies. Materials used in the manufacture of all electronic components and substrates have wide ranges of CTEs as shown in Table 1.

Table 1
CTEs of Typical Components and Substrates

Material	CTE (ppm/°C)
Alloy 42	5.3
Alumina	~7
Barium Titanate Capacitor Body	10-12
Copper	17.6
Copper Clad Invar	6-7
Filled Epoxy Resin (T_R)	18-25
FR4/G-10 PC Board (X, Y)	~18
Nickel or Steel	15
Polyimide/Glass PCB (X, Y)	~12
Polyimide/Kevlar PCB (X, Y)	~7
Tantalum	6.5
Tin Lead Alloys	~27

Linear Displacement

This CTE difference translates into mechanical stress that is due to the linear displacement of substrate and component. Linear displacement is a function of ΔCTE ($\text{CTE}_{\text{sub}} - \text{CTE}_{\text{comp}}$) and the overall length of the component. Long components/ substrates have large linear displacements even with a small ΔCTE which will cause high stress in the solder joints and fatigue after a few temperature cycles. Figure 1 shows linear displacement for conditions where ΔCTE is positive and negative.

* Reference AVX Technical Information paper, “Processing Guidelines for SMPS Capacitors.”

SMPS Capacitors

Assembly Guidelines

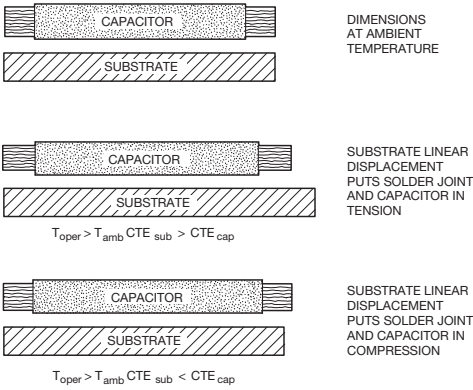

Figure 1. Linear Displacement Between Component and Substrate

General Processing Guidelines

Figure 2 shows the location of maximum stress in the solder joint due to positive and negative DCTE and linear displacement.

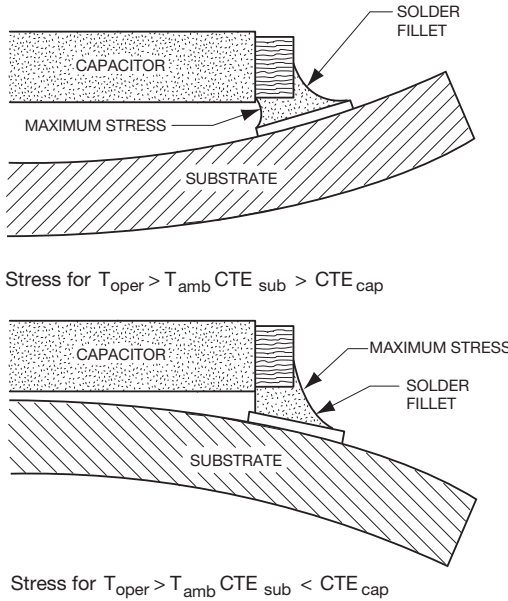

Figure 2

Stress Relief

Leadframes on larger capacitor sizes (greater than 2225) must be used to minimize mechanical stress on the solder joints during temperature cycling which is normal operation for power supplies (Figure 3). Failing solder joints increase both ESR and ESL causing an increase in ripple, noise and heat, accelerating failure.

Layout

Effective solder dams must be used to keep all molten solder on the solder lands during reflow or solder will migrate away from the land, causing opens or weak solder joints. High frequency output filters cannot use low power layout techniques such as necked down conductors because of the stringent inductance requirements.

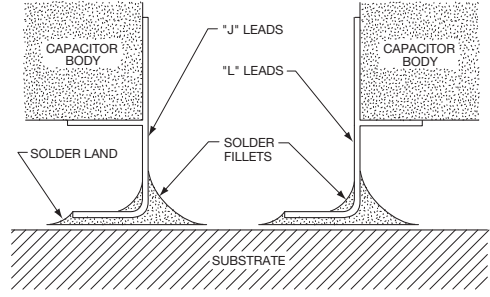

Figure 3. "J" and "L" Leadframes Mounted on Capacitors to Relieve Stress

Inductance

Adding leadframes has a small impact on component inductance but this is the price that must be paid for reliable operation over temperature. Figure 4 shows typical leadframe inductance that is added for two lead standoff distances (0.020" and 0.050") versus the number of leads along one side of SupraCap® which are specifically designed output filter capacitors for 1 MHz and above switchers. The actual inductance will be somewhat less because the leadframes flare out from the lead where the leadframe is attached to the capacitor body.

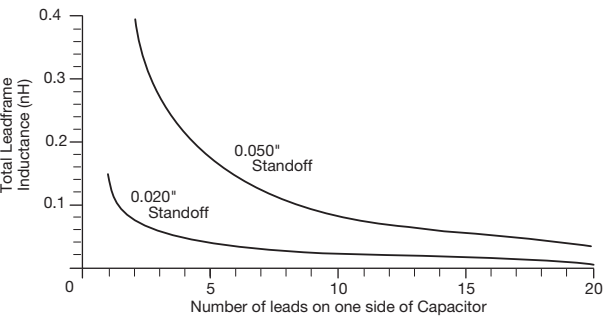

Figure 4. Number of Leads on One Side of Capacitor vs. Total Leadframe Inductance vs. Substrate Standoff Height

Very high frequency switch mode power supplies place tremendous restrictions on output filter capacitors. In addition to handling high ripple current (low ESR), ESL must approach zero nano henrys, part must be truly surface mountable and be available in new configurations to be integrated into transmission lines to further reduce inductance with load currents greater than 40A at 1 MHz and as frequencies move above 1-2 MHz.

The total inductance is the sum of each side of the part where the inductance of one side is the parallel combination of each lead in the leadframe. That inductance is given by:

$$L \text{ (nH)} = 5 \times \ell \left[\ln \left(\frac{2 \times \ell}{B+C} \right) + \frac{1}{2} \right]$$

Where ℓ = lead length in inches
 \ln = natural log
 $B+C$ = lead cross section in inches
 so $L_1 \text{ (nH)} = 2 \times L \text{ (nH)}$ where L_1 is the total inductance of the leadframe.

SMPS Capacitors (SK Style)



Commercial Radial Range

PRODUCT OFFERING – C0G, X7R AND Z5U

AVX SK styles are conformally coated MLC capacitors for input or output filtering in switch mode power supplies. They are specially processed to handle high currents and are low enough in cost for commercial SMPS application.

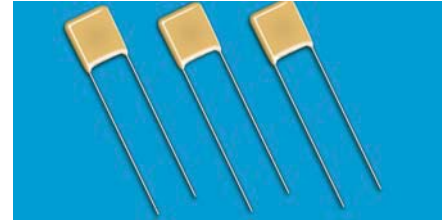

ELECTRICAL SPECIFICATIONS

Temperature Coefficient

C0G: A Temperature Coefficient - 0 ± 30 ppm/°C, -55° to +125°C

X7R: C Temperature Coefficient - $\pm 15\%$, -55° to +125°C

Z5U: E Temperature Coefficient - +22, -56%, +10° to +85°C

Capacitance Test (MIL-STD-202 Method 305)

C0G: 25°C, 1.0 ± 0.2 Vrms (open circuit voltage) at 1KHz

X7R: 25°C, 1.0 ± 0.2 Vrms (open circuit voltage) at 1KHz

Z5U: 25°C, 0.5 Vrms max (open circuit voltage) at 1KHz

Dissipation Factor 25°C

C0G: 0.15% Max @ 25°C, 1.0 ± 0.2 Vrms (open circuit voltage) at 1KHz

X7R: 2.5% Max @ 25°C, 1.0 ± 0.2 Vrms (open circuit voltage) at 1KHz

Z5U: 3.0% Max @ 25°C, 0.5 Vrms max (open circuit voltage) at 1KHz

Insulation Resistance 25°C (MIL-STD-202 Method 302)

C0G and X7R: 100K MΩ or 1000 MΩ-μF, whichever is less.

Z5U: 10K MΩ or 1000 MΩ-μF, whichever is less.

Insulation Resistance 125°C (MIL-STD-202 Method 302)

C0G and X7R: 10K MΩ or 100 MΩ-μF, whichever is less.

Z5U: 1K MΩ or 100 MΩ-μF, whichever is less.

Dielectric Withstanding Voltage 25°C (Flash Test)

C0G and X7R: 250% rated voltage for 5 seconds with 50 mA max charging current. (500 Volt units @ 750 VDC)

Z5U: 200% rated voltage for 5 seconds with 50 mA max charging current.

Life Test (1000 hrs)

C0G and X7R: 200% rated voltage at +125°C. (500 Volt units @ 600 VDC)

Z5U: 150% rated voltage at +85°C

Moisture Resistance (MIL-STD-202 Method 106)

C0G, X7R, Z5U: Ten cycles with no voltage applied.

Thermal Shock (MIL-STD-202 Method 107, Condition A)

Immersion Cycling (MIL-STD-202 Method 104, Condition B)

Resistance To Solder Heat (MIL-STD-202, Method 210, Condition B, for 20 seconds)

HOW TO ORDER

SK	01	3	E	125	Z	A	A	*
Style	Size See chart below	Voltage 25V = 3 50V = 5 100V = 1 200V = 2 500V = 7	Temperature Coefficient Z5U = E X7R = C C0G = A	Capacitance Code (2 significant digits + no. of zeros) 22 nF = 223 220 nF = 224 1 μF = 105 100 μF = 107	Capacitance Tolerance C0G: J = ±5% K = ±10% M = ±20% X7R: K = ±10% M = ±20% Z = +80, -20% Z5U: M = ±20% Z = +80, -20% P = GMV (+100, -0%)	Test Level A = Standard B = Hi-Rel*	Leads A = Tin/Lead R = RoHS Compliant	Packaging (See Note 1)

Note 1: No suffix signifies bulk packaging, which is AVX standard packaging. SK01, SK*3, SK*4, SK*5, SK*6, SK*9 & SK*0 are available taped and reel per EIA-468. Use suffix "TR1" if tape & reel is required.

Note: Capacitors with X7R and Z5U dielectrics are not intended for applications across AC supply mains or AC line filtering with polarity reversal. Contact plant for recommendations.

*Hi-Rel screening for C0G and X7R only. Screening consists of 100% Group A (B Level), Subgroup 1 per MIL-PRF-49470.

TAPE & REEL QUANTITY	
Part	Pieces
SK01	2000
SK03/SK53	1000
SK04/SK54	1000
SK05/SK55	500
SK06/SK56	500
SK07	N/A
SK08	N/A
SK09/SK59	500
SK10/SK60	400

RoHS	
Part	Available
SK01	Yes
SK03/SK53	Yes
SK04/SK54	Yes
SK05/SK55	Yes
SK06/SK56	Yes
SK07	No
SK08	No
SK09/SK59	Yes
SK10/SK60	Yes



SMPS Capacitors (SK Style)



Product Offering – C0G, X7R and Z5U

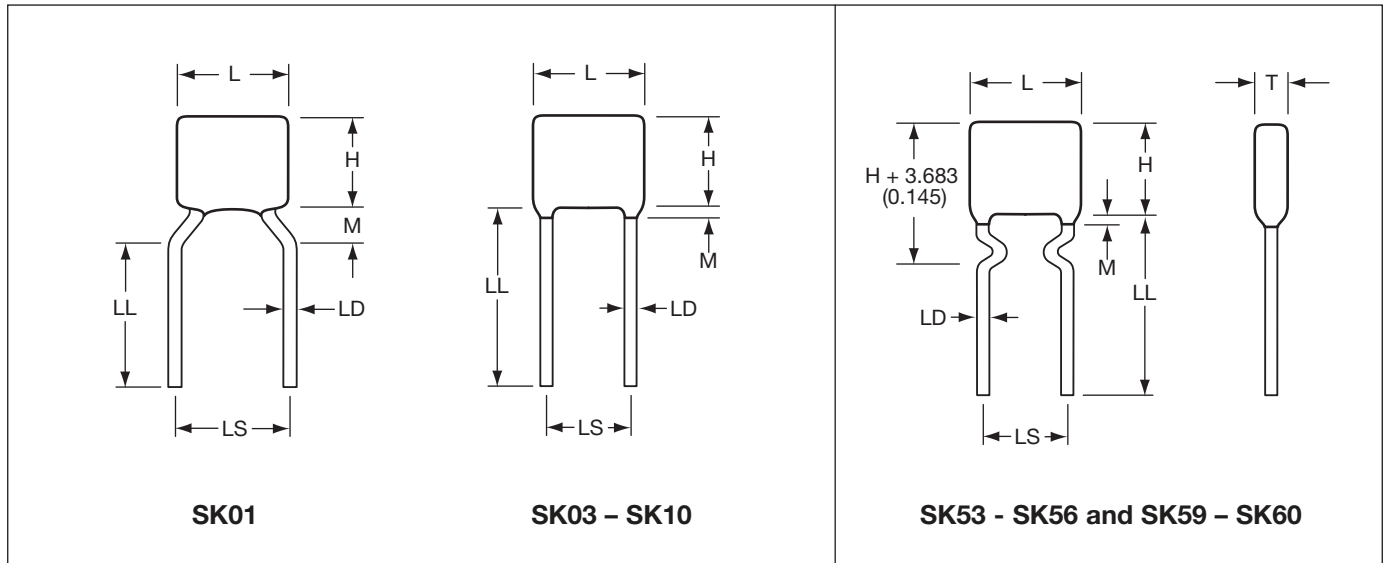

C0G Capacitance Range (µF)

Style	25 WVDC min./max.	50 WVDC min./max.	100 WVDC min./max.	200 WVDC min./max.	500 WVDC min./max.
SK01	.001/0.015	.001/0.012	.001/0.010	.0010/0.0056	.0010/0.0018
SK03/SK53	.01/0.056	.01/0.047	.01/0.039	.0010/0.022	.0010/0.0068
SK04/SK54	.01/0.12	.01/0.10	.01/0.082	.01/0.047	.001/0.015
SK05/SK55	.01/0.18	.01/0.15	.01/0.12	.01/0.068	.001/0.022
SK06/SK56	.10/0.56	.01/0.47	.01/0.39	.01/0.22	.01/0.068
SK07	.10/0.68	.01/0.56	.01/0.47	.01/0.27	.01/0.082
SK08	.82/1.20	.68/1.10	.56/0.82	.33/0.47	.10/0.15
SK09/SK59	.10/0.27	.01/0.22	.01/0.18	.01/0.10	.001/0.039
SK10/SK60	.10/0.68	.01/0.56	.01/0.47	.01/0.27	.01/0.082

X7R Capacitance Range (µF)

Style	25 WVDC min./max.	50 WVDC min./max.	100 WVDC min./max.	200 WVDC min./max.	500 WVDC min./max.
SK01	.01/0.39	.01/0.33	.01/0.27	.01/0.12	.001/0.047
SK03/SK53	.10/2.2	.10/1.8	.01/1.5	.01/0.68	.01/0.27
SK04/SK54	.10/4.7	.10/3.3	.10/2.7	.01/1.0	.01/0.47
SK05/SK55	.10/6.8	.10/6.8	.10/3.9	.10/1.8	.01/0.68
SK06/SK56	1.0/15	1.0/10	.10/5.6	.10/3.9	.10/1.5
SK07	1.0/18	1.0/14	1.0/8.2	.10/4.7	.10/2.2
SK08	22/33	15/22	10/15	5.6/8.2	2.2/3.9
SK09/SK59	.10/8.2	.10/5.6	.10/3.3	.10/2.2	.10/1.2
SK10/SK60	1.0/18	1.0/12	.10/6.8	.10/4.7	.10/2.2

Z5U Capacitance Range (µF)

Style	25 WVDC min./max.	50 WVDC min./max.	100 WVDC min./max.	200 WVDC min./max.
SK01	.10/1.2	.10/0.82	.10/0.47	.10/0.33
SK03/SK53	.10/5.6	.10/3.30	.10/2.20	.10/1.50
SK04/SK54	1.0/10.0	1.0/8.20	.10/4.70	.10/3.30
SK05/SK55	1.0/18.0	1.0/10.00	1.0/6.80	.10/4.70
SK06/SK56	1.0/47.0	1.0/39.00	1.0/22.00	1.0/15.00
SK07	1.0/68.0	1.0/47.00	1.0/27.00	1.0/18.00
SK08	82/120.0	56/100.00	33/47.00	22/33.00
SK09/SK59	1.0/27.0	1.0/18.00	1.0/10.00	1.0/6.80
SK10/SK60	1.0/56.0	1.0/39.00	1.0/22.00	1.0/18.00

DIMENSIONS

millimeters (inches)

Style	L (max.)	H (max.)	T (max.)	LS (nom.)	LD (nom.)
SK01	5.08 (0.200)	5.08 (0.200)	5.08 (0.200)	5.08 (0.200)	0.508 (0.020)
SK03/SK53	7.62 (0.300)	7.62 (0.300)	5.08 (0.200)	5.08 (0.200)	0.508 (0.020)
SK04/SK54	10.2 (0.400)	10.2 (0.400)	5.08 (0.200)	5.08 (0.200)	0.508 (0.020)
SK05/SK55	12.7 (0.500)	12.7 (0.500)	5.08 (0.200)	10.2 (0.400)	0.635 (0.025)
SK06/SK56	22.1 (0.870)	15.2 (0.600)	5.08 (0.200)	20.1 (0.790)	0.813 (0.032)
SK07	27.9 (1.100)	15.2 (0.600)	5.08 (0.200)	24.9 (0.980)	0.813 (0.032)
SK08	27.9 (1.100)	15.2 (0.600)	8.89 (0.350)	24.9 (0.980)	0.813 (0.032)
SK09/SK59	17.0 (0.670)	13.7 (0.540)	5.08 (0.200)	14.6 (0.575)	0.635 (0.025)
SK10/SK60	23.6 (0.930)	18.3 (0.720)	6.35 (0.250)	20.3 (0.800)	0.813 (0.032)

L = Length
H = Height
T = Thickness
M = Meniscus 1.52 (0.060) max.
LS = Lead Spacing Nominal ±.787 (0.031)
LL = Lead Length 50.8 (2.000) max./25.4 (1.000) min.
LD = Lead Diameter Nominal ±.050 (0.002)



SMPS Capacitors (SE Style)



Extended Commercial Radial Range

PRODUCT OFFERING – X7R

AVX SE styles offer capacitance extension to popular SK ranges. The CV product for SE-series, X7R capacitors (TCC: $\pm 15\%$ over -55 to $+125^\circ\text{C}$) compares favorably to high CV ranges offered by other suppliers in much less stable Y5U dielectric (TCC: $+22/-56\%$ over -30 to $+85^\circ\text{C}$). SE style capacitors are conformally coated and are designed for input and output filtering applications in switch mode power supplies.

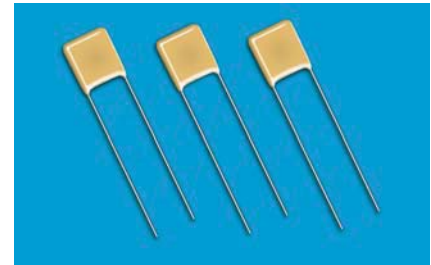

ELECTRICAL SPECIFICATIONS

Temperature Coefficient

X7R: Temperature Coefficient $\pm 15\%$, -55° to $+125^\circ\text{C}$

Capacitance Test (MIL-STD-202 Method 305)

X7R: 25°C , 1.0 ± 0.2 Vrms (open circuit voltage) at 1KHz

Dissipation Factor 25°C

X7R: 2.5% Max @ 25°C , 1.0 ± 0.2 Vrms (open circuit voltage) at 1KHz

Insulation Resistance 25°C (MIL-STD-202 Method 302)

X7R: 100K M Ω or 1000 M Ω - μF , whichever is less.

Insulation Resistance 125°C (MIL-STD-202 Method 302)

X7R: 10K M Ω or 100 M Ω - μF , whichever is less.

Dielectric Withstanding Voltage 25°C (Flash Test)

X7R: 250% rated voltage for 5 seconds with 50 mA max charging current.

Life Test (1000 hrs)

X7R: 200% rated voltage at $+125^\circ\text{C}$

Moisture Resistance (MIL-STD-202 Method 106)

X7R: Ten cycles with no voltage applied.

Thermal Shock (MIL-STD-202 Method 107, Condition A)

Immersion Cycling (MIL-STD-202 Method 104, Condition B)

Resistance To Solder Heat (MIL-STD-202, Method 210, Condition B, for 20 seconds)

HOW TO ORDER

SE	01	3	C	125	M	A	A	*
Style	Size See chart below	Voltage 25V = 3 50V = 5 100V = 1	Temperature Coefficient X7R = C	Capacitance Code (2 significant digits + no. of zeros) 22 nF = 223 220 nF = 224 1 μF = 105 100 μF = 107	Capacitance Tolerance X7R: K = $\pm 10\%$ M = $\pm 20\%$ Z = $+80, -20\%$	Test Level A = Standard B = Hi-Rel*	Leads A = Tin/Lead R = RoHS Compliant	Packaging (See Note 1)

Note 1: No suffix signifies bulk packaging, which is AVX standard packaging. Parts available tape and reel per EIA-468. Use suffix "TR1" if tape & reel is required.

Note: Capacitors with X7R dielectrics are not intended for applications across AC supply mains or AC line filtering with polarity reversal. Contact plant for recommendations.

*Hi-Rel screening consists of 100% Group A, Subgroup 1 per MIL-PRF-39014.

TAPE & REEL QUANTITY	
Part	Pieces
SE01	2000
SE03/SE53	1000
SE04/SE54	1000
SE05/SE55	500
SE06/SE56	500

RoHS	
Part	Available
SE01	Yes
SE03/SE53	Yes
SE04/SE54	Yes
SE05/SE55	Yes
SE06/SE56	Yes



SMPS Capacitors (SE Style)



Product Offering – X7R

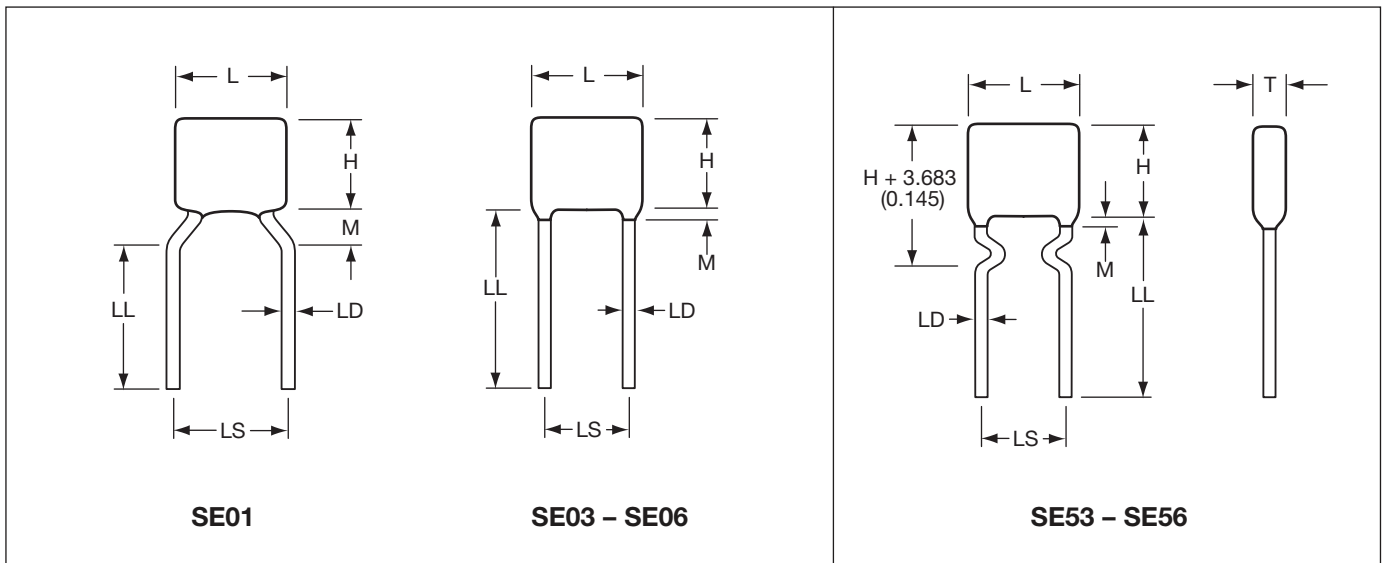

X7R Capacitance Range (μF)

Style	25 WVDC min./max.	50 WVDC min./max.	100 WVDC min./max.
SE01	0.47/1.5	0.39/1.0	0.33/0.68
SE03/SE53	2.7/6.8	2.2/4.7	1.8/3.3
SE04/SE54	5.6/12	3.9/10	3.3/6.8
SE05/SE55	8.2/18	6.8/12	4.7/10.0
SE06/SE56	18/39	12/27	6.8/15

DIMENSIONS

millimeters (inches)

Style	L (max.)	H (max.)	T (max.)	LS (nom.)	LD (nom.)
SE01	5.08 (0.200)	5.08 (0.200)	5.08 (0.200)	5.08 (0.200)	0.508 (0.020)
SE03/SE53	7.62 (0.300)	7.62 (0.300)	5.08 (0.200)	5.08 (0.200)	0.508 (0.020)
SE04/SE54	10.2 (0.400)	10.2 (0.400)	5.08 (0.200)	5.08 (0.200)	0.508 (0.020)
SE05/SE55	12.7 (0.500)	12.7 (0.500)	5.08 (0.200)	10.2 (0.400)	0.635 (0.025)
SE06/SE56	22.1 (0.870)	15.2 (0.600)	5.08 (0.200)	20.1 (0.790)	0.813 (0.032)
L = Length H = Height		T = Thickness M = Meniscus 1.52 (0.060) max.		LS = Lead Spacing Nominal ± 0.787 (0.031) LL = Lead Length 50.8 (2.000) max./25.4 (1.000 min.) LD = Lead Diameter Nominal ± 0.050 (0.002)	



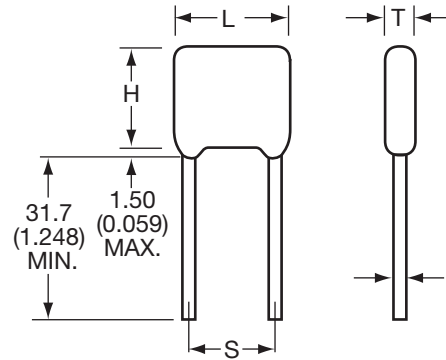

DIMENSIONS

millimeters (inches)

Size Code	Length (L) (max.)	Height (H) (max.)	Thickness (T) (max.)	Nom (t)	S ±0.4
BR40	10.16 (0.400)	11.7 (0.460)	3.81 (0.150)	0.51 (0.020)	5.08 (0.200)
BR50	12.7 (0.500)	12.7 (0.500)	5.1 (0.200)	0.64 (0.025)	10.16 (0.400)
BR84	23.6 (0.930)	17.78 (0.700)	6.35 (0.250)	0.76 (0.030)	20.32 (0.800)

CECC APPROVED RANGE

	1B/C0G CECC 30 601 801 Issue 1				2C1/X7R CECC 30 701 801 Issue 1			
	50V	100V	200V	500V	50V	100V	200V	500V
BR40	683-104	473-683	333-473	4R5-153	185-275	125-185	334-474	473-154
BR50	124-224	104-154	683-104	820-333	395-475	225-275	684-105	104-394
BR84	104-564	104-474	104-334	223-104	475-186	475-156	105-335	474-155

HOW TO ORDER

BR

Style Code

84

Size Code
See table above

1

Voltage Code
5 = 50V
1 = 100V
2 = 200V
7 = 500V

C

Dielectric Code
A = C0G
C = X7R

156

Capacitance Code
(2 significant digits + no. of zeros)

K

Capacitance Tolerance
G = ±2%
C0G only
J = ±5%
C0G only
K = ±10%
M = ±20%
P = -0 +100%

T

Specification Code
T = CECC

A

Lead Length Code
A = 31.7mm min.

Note: If tape and reel is required, add TR to the end of the part number

ESCC Qualified SMPS Capacitors



High Voltage Chip/Leaded Capacitors

HIGH VOLTAGE CHIP CAPACITORS

Capacitors, Fixed, Chip, Ceramic Dielectric, Type II, High Voltage, Based on Styles 1812 and 1825 for use in ESCC space programs, according to ESCC Generic Specification 3009 and associated Detail Specification 3009/034 as recommended by the Space Components Coordination Group. (ranges in table below)

Note: Variants 01 to 12: metallized pads

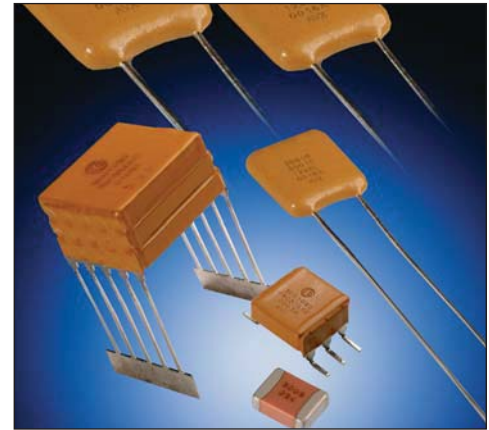

Size	Variant	Rated Voltage (kV)	Tolerance (%)	Capacitance Code (E12)
1812	01	1.0	±10	392 - 223
	02		±20	
	03	2.0	±10	152 - 182
	04		±20	
	05	3.0	±10	821 - 102
	06		±20	
1825	07	1.0	±10	273 - 563
	08		±20	
	09	2.0	±10	222 - 682
	10		±20	
	11	3.0	±10	821 - 392
	12		±20	

HOW TO ORDER

Parts should be ordered using the ESCC variant number as follows:

3009034

XX
Type Variant
(per table)

B

Test Level

C = Standard test level
B = Level C plus serialized and capacitance recorded before and after 100% burn-in.

XXX

Capacitance Code

The first two digits represent significant figures and the third digit specifies the number of zeros to follow; i.e.
102 = 1000pF
103 = 10000pF

Eg 300903401C223

HIGH VOLTAGE LEADED CAPACITORS

Capacitors, Fixed, Ceramic Dielectric, Type II, High Voltage, 1.0 to 5.0 kV, Based on Case Styles VR, CV and CH for use in ESCC space programs, according to ESCC Generic Specification 3001 and associated Detail Specification 3001/034 as recommended by the Space Components Coordination Group. (ranges in table)

Note 1: Lead Types

- a - Leaded Radial (epoxy coated)
- b - Leaded Radial (Polyurethane Varnish)
- c - Straight Dual in Line
- d - L Dual in Line

Note 2: Tolerances of ±10% and ±20% are available

Case Size	Variant	Lead Type	Capacitance Code (E12)				
			1.0kV	2.0kV	3.0kV	4.0kV	5.0kV
VR30S	01	a	392 - 203	152 - 182	821 - 102		
VR30	02	a	273 - 563	222 - 682	821 - 392		
VR40	03	a	473 - 124	822 - 153	472 - 103	182 - 222	
VR50	04	a	154 - 274	183 - 333	123 - 183	562 - 822	332 - 392
VR66	05	a	224 - 564	393 - 823	223 - 393	103 - 153	682 - 103
VR84	06	a	684 - 105	473 - 154	473 - 683	183 - 393	123 - 183
VR90	07	a	125 - 275	184 - 334	823 - 184	473 - 124	223 - 563
CV41	08	b	473 - 124	822 - 153	472 - 103	182 - 222	
CH41	09	c	473 - 124	822 - 153	472 - 103	182 - 222	
CH41	10	d	473 - 124	822 - 153	472 - 103	182 - 222	
CV51	11	b	154 - 274	183 - 333	123 - 183	562 - 822	332 - 392
CH51	12	c	154 - 274	183 - 333	123 - 183	562 - 822	332 - 392
CH51	13	d	154 - 274	183 - 333	123 - 183	562 - 822	332 - 392
CV61	14	b	224 - 564	393 - 823	223 - 393	103 - 153	682 - 103
CH61	15	c	224 - 564	393 - 823	223 - 393	103 - 153	682 - 103
CH61	16	d	224 - 564	393 - 823	223 - 393	103 - 153	682 - 103
CV76	17	b	684 - 105	473 - 154	473 - 683	183 - 393	123 - 183
CH76	18	c	684 - 105	473 - 154	473 - 683	183 - 393	123 - 183
CH76	19	d	684 - 105	473 - 154	473 - 683	183 - 393	123 - 183
CV91	20	b	125 - 275	184 - 334	823 - 184	473 - 124	223 - 563
CH91	21	c	125 - 275	184 - 334	823 - 184	473 - 124	223 - 563
CH91	22	d	125 - 275	184 - 334	823 - 184	473 - 124	223 - 563

HOW TO ORDER

Parts should be ordered using the ESCC variant number as follows:

3001034

Detail Spec Number

XX

Type Variant
(per table above)

B

Test Level
C = Standard test level
B = Level C plus serialized and capacitance recorded before and after 100% burn-in.

XXX

Capacitance Code

The first two digits represent significant figures and the third digit specifies the number of zeros to follow; i.e.
102 = 1000pF
103 = 10000pF

K

Capacitance Tolerance
K = 10%
M = 20%

X

Voltage
M = 1kV
P = 2kV
R = 3kV
S = 4kV
Z = 5kV

Eg 300103412C274KM



ESCC Qualified SMPS Capacitors



High Capacitance

HIGH CAPACITANCE LEADED CAPACITORS

Capacitors, Fixed, Ceramic Dielectric, Type II, High Capacitance, Based on Case Styles BR, CV and CH for use in ESCC space programs, according to ESCC Generic Specification 3001 and associated Detail Specification 3001/030 as recommended by the Space Components Coordination Group. (see ranges in table below)

Note 1: Lead Types

- a - Leaded Radial (epoxy coated)
- b - Leaded Radial (Polyurethane Varnish)
- c - Straight Dual in Line
- d - L Dual in Line

Note 2: Tolerances of ±10% and ±20% are available

Case Size	Variant	Figure	Capacitance Code (E12)			
			50V	100V	200V	500V
BR40	01	a	185 - 335	125 - 275	334 - 564	124 - 224
BR50	02	a	395 - 565	225 - 395	684 - 105	274 - 394
BR66	03	a	685 - 106	475 - 825	105 - 225	474 - 105
BR72	04	a	126 - 186	825 - 156	225 - 335	824 - 155
BR84	05	a	126 - 186	825 - 156	225 - 335	824 - 155
CV41	06	b	185 - 335	125 - 275	334 - 564	124 - 224
CH41	07	c	185 - 335	125 - 275	334 - 564	124 - 224
CH41	08	d	185 - 335	125 - 275	334 - 564	124 - 224
CH42	09	c	395 - 685	335 - 565	684 - 125	274 - 474
CH42	10	d	395 - 685	335 - 565	684 - 125	274 - 474
CH43	11	c	825 - 106	685 - 825	155 - 185	564 - 684
CH43	12	d	825 - 106	685 - 825	155 - 185	564 - 684
CH44	13	c	126	106	225	824 - 105
CH44	14	d	126	106	225	824 - 105
CV51	15	b	395 - 565	225 - 395	684 - 105	274 - 394
CH51	16	c	395 - 565	225 - 395	684 - 105	274 - 394
CH51	17	d	395 - 565	225 - 395	684 - 105	274 - 394
CH52	18	c	685 - 106	475 - 825	125 - 225	474 - 824
CH52	19	d	685 - 106	475 - 825	125 - 225	474 - 824
CH53	20	c	126 - 156	106 - 126	275 - 335	105 - 125
CH53	21	d	126 - 156	106 - 126	275 - 335	105 - 125
CH54	22	c	186 - 226	156	395	155
CH54	23	d	186 - 226	156	395	155
CV61	24	b	685 - 106	475 - 825	105 - 225	474 - 105
CH61	25	c	685 - 106	475 - 825	105 - 225	474 - 105
CH61	26	d	685 - 106	475 - 825	105 - 225	474 - 105
CH62	27	c	126 - 226	106 - 156	275 - 475	105 - 185
CH62	28	d	126 - 226	106 - 156	275 - 475	105 - 185
CH63	29	c	276 - 336	186 - 226	565 - 685	225 - 275
CH63	30	d	276 - 336	186 - 226	565 - 685	225 - 275
CH64	31	c	396	276 - 336	825 - 106	335
CH64	32	d	396	276 - 336	825 - 106	335
CV71	33	b	126 - 186	825 - 156	225 - 335	824 - 155
CH71	34	c	126 - 186	825 - 156	225 - 335	824 - 155
CH71	35	d	126 - 186	825 - 156	225 - 335	824 - 155
CH72	36	c	226 - 396	186 - 276	395 - 685	185 - 335
CH72	37	d	226 - 396	186 - 276	395 - 685	185 - 335

Case Size	Variant	Figure	Capacitance Code (E12)			
			50V	100V	200V	500V
CH73	38	c	476 - 566	336 - 396	825 - 106	395 - 475
CH73	39	d	476 - 566	336 - 396	825 - 106	395 - 475
CH74	40	c	686	476	126	565
CH74	41	d	686	476	126	565
CV76	42	b	126 - 186	825 - 156	225 - 335	824 - 155
CH76	43	c	126 - 186	825 - 156	225 - 335	824 - 155
CH76	44	d	126 - 186	825 - 156	225 - 335	824 - 155
CH77	45	c	226 - 396	186 - 276	395 - 685	185 - 335
CH77	46	d	226 - 396	186 - 276	395 - 685	185 - 335
CH78	47	c	476 - 566	336 - 396	825 - 106	395 - 475
CH78	48	d	476 - 566	336 - 396	825 - 106	395 - 475
CH79	49	c	686	476	126	565
CH79	50	d	686	476	126	565
CH81	51	c	156 - 226	126 - 186	225 - 395	824 - 155
CH81	52	d	156 - 226	126 - 186	225 - 395	824 - 155
CH82	53	c	276 - 476	226 - 396	475 - 825	
CH82	54	d	276 - 476	226 - 396	475 - 825	
CH83	55	c	566 - 686	476 - 566	106 - 126	
CH83	56	d	566 - 686	476 - 566	106 - 126	
CH84	57	c	826	686	156	
CH84	58	d	826	686	156	
CH86	59	c	226 - 336	156 - 276	395 - 685	155 - 225
CH86	60	d	226 - 336	156 - 276	395 - 685	155 - 225
CH87	61	c	396 - 686	336 - 566	825 - 156	
CH87	62	d	396 - 686	336 - 566	825 - 156	
CH88	63	c	826 - 107	686 - 826	186 - 226	
CH88	64	d	826 - 107	686 - 826	186 - 226	
CH89	65	c	127	107	276	
CH89	66	d	127	107	276	
CH91	67	c	396 - 476	336 - 396	825 - 106	
CH91	68	d	396 - 476	336 - 396	825 - 106	
CH92	69	c	566 - 107	476 - 826	126 - 226	
CH92	70	d	566 - 107	476 - 826	126 - 226	
CH93	71	c	127 - 157	107 - 127	276 - 336	
CH93	72	d	127 - 157	107 - 127	276 - 336	
CH94	73	c	187	157	396	
CH94	74	d	187	157	396	

HOW TO ORDER

Parts should be ordered using the ESCC variant number as follows:

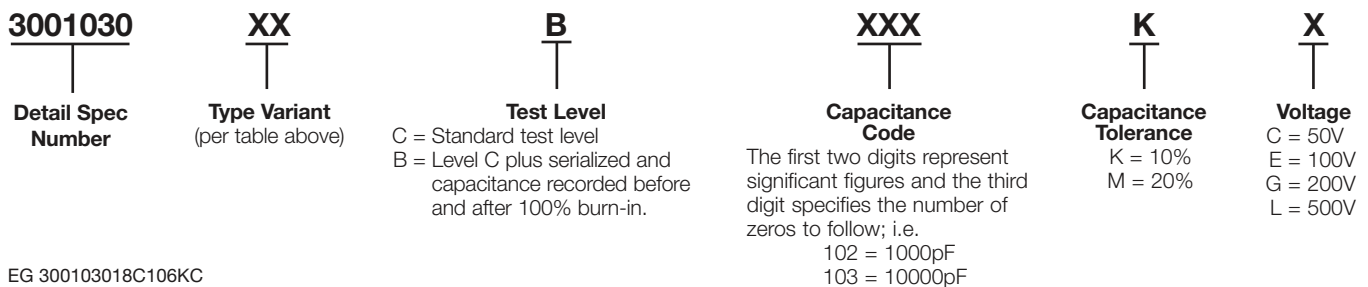

EG 300103018C106KC

Lot Acceptance Testing is available for all our ESCC qualified ranges.

- LAT 1 42 samples → 12 mechanical + 20 life test + 6 for TC + 4 for solder
- LAT 2 30 samples → 20 life test + 6 for TC + 4 for solder
- LAT 3 10 samples → 6 for TC + 4 for solder



ESCC DETAIL SPECIFICATION NO. 3009/034 PHYSICAL DIMENSIONS

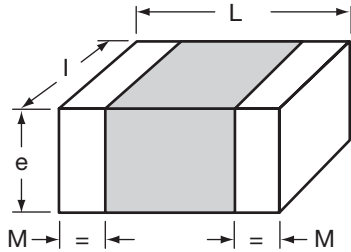

Millimeters (Inches)

Symbol	Variants 01 to 06		Variants 07 to 12	
	Min.	Max.	Min.	Max.
L	4.20 (0.165)	5.00 (0.197)	4.20 (0.165)	5.00 (0.197)
l	2.80 (0.110)	3.60 (0.142)	5.67 (0.223)	6.67 (0.263)
e	-	3.00 (0.118)	-	3.30 (0.130)
M	0.25 (0.010)	0.75 (0.030)	0.25 (0.010)	0.75 (0.030)

ESCC DETAIL SPECIFICATION NO. 3001/034 PHYSICAL DIMENSIONS – VR STYLE

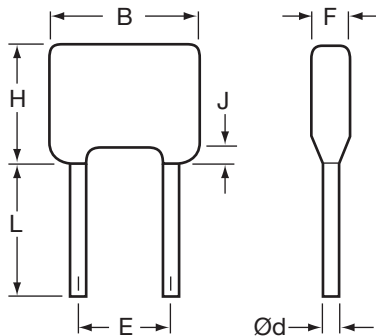

Millimeters (Inches)

Variant	Case Size	B	Ød		E		F	H	J	L
		Max.	Min.	Max.	Min.	Max.	Max.	Max.	Max.	Min.
01	VR30S	7.62 (0.300)	0.46 (0.018)	0.56 (0.022)	4.58 (0.180)	5.58 (0.220)	5.00 (0.197)	4.60 (0.181)	1.50 (0.059)	31.7 (1.248)
02	VR30	7.62 (0.300)	0.46 (0.018)	0.56 (0.022)	4.58 (0.180)	5.58 (0.220)	5.00 (0.197)	9.62 (0.379)	1.50 (0.059)	31.7 (1.248)
03	VR40	10.16 (0.400)	0.46 (0.018)	0.56 (0.022)	4.58 (0.180)	5.58 (0.220)	5.00 (0.197)	11.7 (0.461)	1.50 (0.059)	31.7 (1.248)
04	VR50	12.7 (0.500)	0.59 (0.023)	0.69 (0.027)	9.66 (0.380)	10.66 (0.420)	5.10 (0.201)	14.2 (0.559)	1.50 (0.059)	31.7 (1.248)
05	VR66	17.5 (0.689)	0.86 (0.034)	0.96 (0.038)	14.2 (0.559)	15.2 (0.598)	6.40 (0.252)	16.5 (0.650)	1.50 (0.059)	31.7 (1.248)
06	VR84	23.62 (0.930)	0.86 (0.034)	0.96 (0.038)	20.4 (0.803)	22.0 (0.866)	6.40 (0.252)	19.78 (0.779)	1.50 (0.059)	31.7 (1.248)
07	VR90	23.5 (0.925)	0.86 (0.034)	0.96 (0.038)	20.4 (0.803)	22.0 (0.866)	6.40 (0.252)	42.0 (1.654)	1.50 (0.059)	31.7 (1.248)

ESCC DETAIL SPECIFICATION NO. 3001/034 PHYSICAL DIMENSIONS – CV STYLE

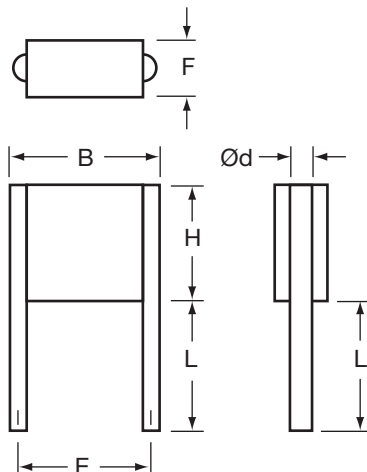

Millimeters (Inches)

Variant	Case Size	B	Ød		E		F	H	L	
		Max.	Min.	Max.	Min.	Max.	Max.	Max.	Min.	Max.
08	CV41	10.6 (0.417)	0.65 (0.026)	0.75 (0.030)	7.70 (0.303)	8.70 (0.343)	3.80 (0.150)	8.70 (0.343)	22.0 (0.866)	28.0 (1.102)
11	CV51	11.9 (0.469)	0.85 (0.033)	0.95 (0.037)	9.66 (0.380)	10.66 (0.420)	3.80 (0.150)	10.7 (0.421)	22.0 (0.866)	28.0 (1.102)
14	CV61	16.5 (0.650)	0.85 (0.033)	0.95 (0.037)	14.74 (0.580)	15.74 (0.620)	3.80 (0.150)	13.6 (0.535)	22.0 (0.866)	28.0 (1.102)
17	CV76	22.7 (0.894)	0.85 (0.033)	0.95 (0.037)	20.4 (0.803)	22.0 (0.866)	3.80 (0.150)	16.6 (0.654)	22.0 (0.866)	28.0 (1.102)
20	CV91	22.7 (0.894)	1.15 (0.045)	1.25 (0.049)	20.4 (0.803)	22.0 (0.866)	3.80 (0.150)	40.6 (1.598)	22.0 (0.866)	28.0 (1.102)

ESCC DETAIL SPECIFICATION NO. 3001/034 PHYSICAL DIMENSIONS – CH STYLE, D.I.L.

Millimeters (Inches)

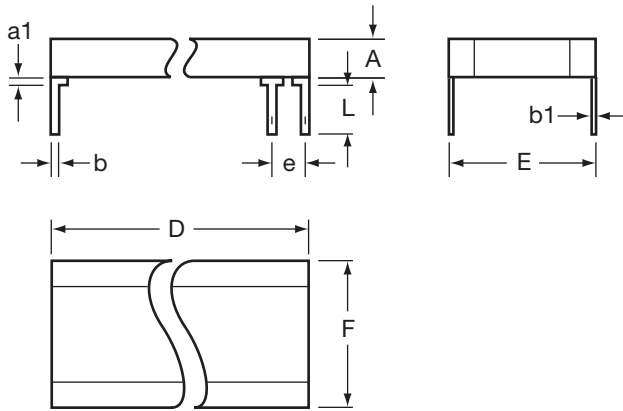

Symbol	Min.	Max.	Notes
a1	-	2.00 (0.079)	1
b	0.45 (0.018)	0.55 (0.022)	1
b1	0.204 (0.008)	0.304 (0.012)	1
e	2.49 (0.098)	2.59 (0.102)	2
L	12.0 (0.472)	14.0 (0.551)	1

Notes: 1 – All leads
2 – Each space

Variant	Case Size	A	D	E		F
		Max.	Max.	Min.	Max.	Max.
07	CH41	3.80 (0.150)	8.70 (0.343)	7.70 (0.303)	8.70 (0.343)	9.20 (0.362)
09	CH42	7.40 (0.291)	8.70 (0.343)	7.70 (0.303)	8.70 (0.343)	9.20 (0.362)
11	CH43	11.1 (0.437)	8.70 (0.343)	7.70 (0.303)	8.70 (0.343)	9.20 (0.362)
13	CH44	14.8 (0.583)	8.70 (0.343)	7.70 (0.303)	8.70 (0.343)	9.20 (0.362)
16	CH51	3.80 (0.150)	10.7 (0.421)	9.66 (0.380)	10.66 (0.420)	10.7 (0.421)
18	CH52	7.40 (0.291)	10.7 (0.421)	9.66 (0.380)	10.66 (0.420)	10.7 (0.421)
20	CH53	11.1 (0.437)	10.7 (0.421)	9.66 (0.380)	10.66 (0.420)	10.7 (0.421)
22	CH54	14.8 (0.583)	10.7 (0.421)	9.66 (0.380)	10.66 (0.420)	10.7 (0.421)
25	CH61	3.80 (0.150)	13.6 (0.535)	13.5 (0.531)	14.5 (0.571)	14.9 (0.587)
27	CH62	7.40 (0.291)	13.6 (0.535)	13.5 (0.531)	14.5 (0.571)	14.9 (0.587)
29	CH63	11.1 (0.437)	13.6 (0.535)	13.5 (0.531)	14.5 (0.571)	14.9 (0.587)
31	CH64	14.8 (0.583)	13.6 (0.535)	13.5 (0.531)	14.5 (0.571)	14.9 (0.587)
34	CH71	3.80 (0.150)	21.6 (0.850)	14.74 (0.580)	15.74 (0.620)	16.8 (0.661)
36	CH72	7.40 (0.291)	21.6 (0.850)	14.74 (0.580)	15.74 (0.620)	16.8 (0.661)
38	CH73	11.1 (0.437)	21.6 (0.850)	14.74 (0.580)	15.74 (0.620)	16.8 (0.661)
40	CH74	14.8 (0.583)	21.6 (0.850)	14.74 (0.580)	15.74 (0.620)	16.8 (0.661)
43	CH76	3.80 (0.150)	16.6 (0.654)	19.52 (0.769)	21.12 (0.831)	21.6 (0.850)
45	CH77	7.40 (0.291)	16.6 (0.654)	19.52 (0.769)	21.12 (0.831)	21.6 (0.850)
47	CH78	11.1 (0.437)	16.6 (0.654)	19.52 (0.769)	21.12 (0.831)	21.6 (0.850)
49	CH79	14.8 (0.583)	16.6 (0.654)	19.52 (0.769)	21.12 (0.831)	21.6 (0.850)
51	CH81	3.80 (0.150)	38.2 (1.504)	9.66 (0.380)	10.66 (0.420)	12.0 (0.472)
53	CH82	7.40 (0.291)	38.2 (1.504)	9.66 (0.380)	10.66 (0.420)	12.0 (0.472)
55	CH83	11.1 (0.437)	38.2 (1.504)	9.66 (0.380)	10.66 (0.420)	12.0 (0.472)
57	CH84	14.8 (0.583)	38.2 (1.504)	9.66 (0.380)	10.66 (0.420)	12.0 (0.472)
59	CH86	3.80 (0.150)	38.2 (1.504)	14.74 (0.580)	15.74 (0.620)	18.9 (0.744)
61	CH87	7.40 (0.291)	38.2 (1.504)	14.74 (0.580)	15.74 (0.620)	18.9 (0.744)
63	CH88	11.1 (0.437)	38.2 (1.504)	14.74 (0.580)	15.74 (0.620)	18.9 (0.744)
65	CH89	14.8 (0.583)	38.2 (1.504)	14.74 (0.580)	15.74 (0.620)	18.9 (0.744)
67	CH91	3.80 (0.150)	40.6 (1.598)	19.52 (0.769)	21.12 (0.831)	24.0 (0.945)
69	CH92	7.40 (0.291)	40.6 (1.598)	19.52 (0.769)	21.12 (0.831)	24.0 (0.945)
71	CH93	11.1 (0.437)	40.6 (1.598)	19.52 (0.769)	21.12 (0.831)	24.0 (0.945)
73	CH94	14.8 (0.583)	40.6 (1.598)	19.52 (0.769)	21.12 (0.831)	24.0 (0.945)

ESCC DETAIL SPECIFICATION NO. 3001/034 PHYSICAL DIMENSIONS – CH STYLE, L

Millimeters (Inches)

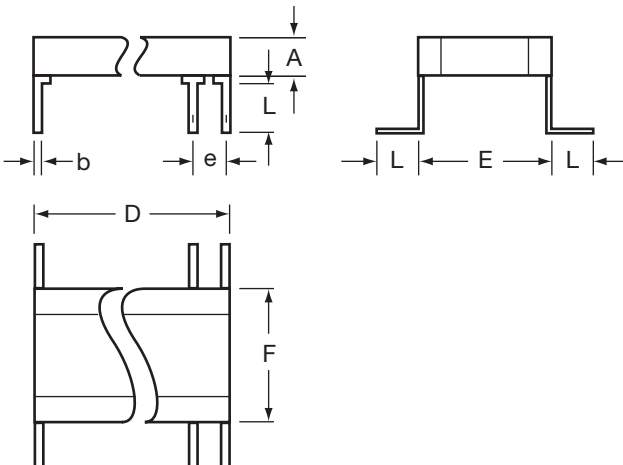

Variant	Case Size	A	D	E		F
		Max.	Max.	Min.	Max.	Max.
10	CH41	3.80 (0.150)	8.70 (0.343)	7.70 (0.303)	8.70 (0.343)	9.20 (0.362)
13	CH51	3.80 (0.150)	10.7 (0.421)	9.66 (0.380)	10.66 (0.420)	10.7 (0.421)
16	CH61	3.80 (0.150)	13.6 (0.535)	13.5 (0.531)	14.5 (0.571)	14.9 (0.587)
19	CH76	3.80 (0.150)	16.6 (0.654)	19.52 (0.769)	21.12 (0.831)	21.6 (0.850)
22	CH91	3.80 (0.150)	40.6 (1.598)	19.52 (0.769)	21.12 (0.831)	24.0 (0.945)

Symbol	Min.	Max.	Notes
b	0.45 (0.018)	0.55 (0.022)	1
e	2.49 (0.098)	2.59 (0.102)	2
L	2.04 (0.080)	3.01 (0.120)	1

Notes: 1 – All leads
2 – Each space

ESCC DETAIL SPECIFICATION NO. 3001/030 PHYSICAL DIMENSIONS – BR STYLE

Millimeters (Inches)

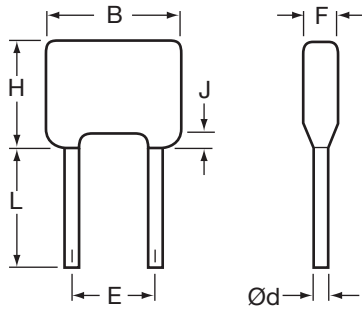

Variant	Case Size	B		Ød		E		F	H	J	L
		Max.	Min.	Max.	Min.	Max.	Max.	Max.	Max.	Min.	
01	BR40	10.16 (0.400)	0.46 (0.018)	0.56 (0.022)	4.58 (0.180)	5.58 (0.220)	5.00 (0.197)	11.7 (0.461)	1.50 (0.059)	31.7 (1.248)	
02	BR50	12.7 (0.500)	0.59 (0.023)	0.69 (0.027)	9.66 (0.380)	10.66 (0.420)	5.10 (0.201)	14.2 (0.559)	1.50 (0.059)	31.7 (1.248)	
03	BR66	17.5 (0.689)	0.86 (0.034)	0.96 (0.038)	14.2 (0.559)	15.2 (0.598)	6.40 (0.252)	16.5 (0.650)	1.50 (0.059)	31.7 (1.248)	
04	BR72	19.3 (0.760)	0.86 (0.034)	0.96 (0.038)	14.74 (0.580)	15.74 (0.620)	6.40 (0.252)	24.0 (0.945)	1.50 (0.059)	31.7 (1.248)	
05	BR84	23.62 (0.930)	0.71 (0.028)	0.81 (0.032)	18.93 (0.745)	20.83 (0.820)	6.40 (0.252)	19.78 (0.779)	1.50 (0.059)	31.7 (1.248)	

ESCC DETAIL SPECIFICATION NO. 3001/030 PHYSICAL DIMENSIONS – CV STYLE

Millimeters (Inches)

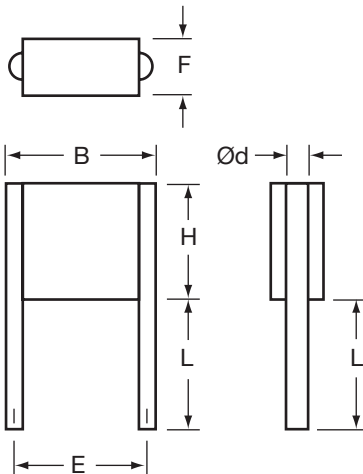

Variant	Case Size	B		Ød		E		F	H	L	
		Max.	Min.	Max.	Min.	Max.	Max.	Max.	Min.	Max.	
06	CV41	10.6 (0.417)	0.65 (0.026)	0.75 (0.030)	7.70 (0.303)	8.70 (0.343)	3.80 (0.150)	8.70 (0.343)	22.0 (0.866)	28.0 (1.102)	
15	CV51	11.9 (0.469)	0.85 (0.033)	0.95 (0.037)	9.66 (0.380)	10.66 (0.420)	3.80 (0.150)	10.7 (0.421)	22.0 (0.866)	28.0 (1.102)	
24	CV61	16.5 (0.650)	0.85 (0.033)	0.95 (0.037)	14.74 (0.580)	15.74 (0.620)	3.80 (0.150)	13.6 (0.535)	22.0 (0.866)	28.0 (1.102)	
33	CV71	17.8 (0.701)	0.85 (0.033)	0.95 (0.037)	14.74 (0.580)	15.74 (0.620)	3.80 (0.150)	21.6 (0.850)	22.0 (0.866)	28.0 (1.102)	
42	CV76	22.7 (0.894)	0.85 (0.033)	0.95 (0.037)	20.4 (0.803)	22.0 (0.866)	3.80 (0.150)	16.6 (0.654)	22.0 (0.866)	28.0 (1.102)	

ESCC DETAIL SPECIFICATION NO. 3001/030 PHYSICAL DIMENSIONS – CH STYLE, D.I.L.

Millimeters (Inches)

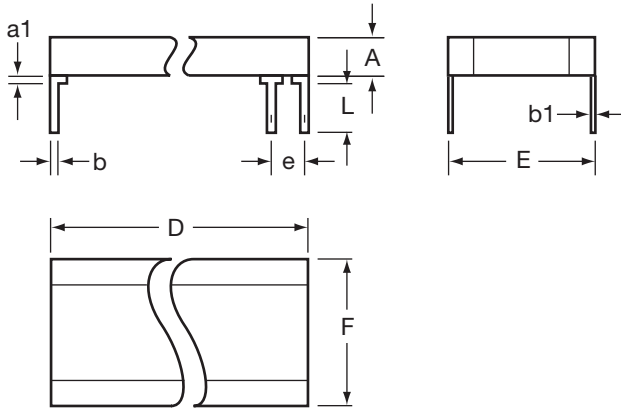

Symbol	Min.	Max.	Notes
a1	-	2.00 (0.079)	1
b	0.45 (0.018)	0.55 (0.022)	1
b1	0.204 (0.008)	0.304 (0.012)	1
e	2.49 (0.098)	2.59 (0.102)	2
L	2.04 (0.080)	3.04 (0.120)	1

Notes: 1 – All leads
2 – Each space

Variant	Case Size	A	D	E		F
		Max.	Max.	Min.	Max.	Max.
07	CH41	3.80 (0.150)	8.70 (0.343)	7.70 (0.303)	8.70 (0.343)	9.20 (0.362)
09	CH42	7.40 (0.291)	8.70 (0.343)	7.70 (0.303)	8.70 (0.343)	9.20 (0.362)
11	CH43	11.1 (0.437)	8.70 (0.343)	7.70 (0.303)	8.70 (0.343)	9.20 (0.362)
13	CH44	14.8 (0.583)	8.70 (0.343)	7.70 (0.303)	8.70 (0.343)	9.20 (0.362)
16	CH51	3.80 (0.150)	10.7 (0.421)	9.66 (0.380)	10.66 (0.420)	10.7 (0.421)
18	CH52	7.40 (0.291)	10.7 (0.421)	9.66 (0.380)	10.66 (0.420)	10.7 (0.421)
20	CH53	11.1 (0.437)	10.7 (0.421)	9.66 (0.380)	10.66 (0.420)	10.7 (0.421)
22	CH54	14.8 (0.583)	10.7 (0.421)	9.66 (0.380)	10.66 (0.420)	10.7 (0.421)
25	CH61	3.80 (0.150)	13.6 (0.535)	13.5 (0.531)	14.5 (0.571)	14.9 (0.587)
27	CH62	7.40 (0.291)	13.6 (0.535)	13.5 (0.531)	14.5 (0.571)	14.9 (0.587)
29	CH63	11.1 (0.437)	13.6 (0.535)	13.5 (0.531)	14.5 (0.571)	14.9 (0.587)
31	CH64	14.8 (0.583)	13.6 (0.535)	13.5 (0.531)	14.5 (0.571)	14.9 (0.587)
34	CH71	3.80 (0.150)	21.6 (0.850)	14.74 (0.580)	15.74 (0.620)	16.8 (0.661)
36	CH72	7.40 (0.291)	21.6 (0.850)	14.74 (0.580)	15.74 (0.620)	16.8 (0.661)
38	CH73	11.1 (0.437)	21.6 (0.850)	14.74 (0.580)	15.74 (0.620)	16.8 (0.661)
40	CH74	14.8 (0.583)	21.6 (0.850)	14.74 (0.580)	15.74 (0.620)	16.8 (0.661)
43	CH76	3.80 (0.150)	16.6 (0.654)	19.52 (0.769)	21.12 (0.831)	21.6 (0.850)
45	CH77	7.40 (0.291)	16.6 (0.654)	19.52 (0.769)	21.12 (0.831)	21.6 (0.850)
47	CH78	11.1 (0.437)	16.6 (0.654)	19.52 (0.769)	21.12 (0.831)	21.6 (0.850)
49	CH79	14.8 (0.583)	16.6 (0.654)	19.52 (0.769)	21.12 (0.831)	21.6 (0.850)
51	CH81	3.80 (0.150)	38.2 (1.504)	9.66 (0.380)	10.66 (0.420)	12.0 (0.472)
53	CH82	7.40 (0.291)	38.2 (1.504)	9.66 (0.380)	10.66 (0.420)	12.0 (0.472)
55	CH83	11.1 (0.437)	38.2 (1.504)	9.66 (0.380)	10.66 (0.420)	12.0 (0.472)
57	CH84	14.8 (0.583)	38.2 (1.504)	9.66 (0.380)	10.66 (0.420)	12.0 (0.472)
59	CH86	3.80 (0.150)	38.2 (1.504)	14.74 (0.580)	15.74 (0.620)	18.9 (0.744)
61	CH87	7.40 (0.291)	38.2 (1.504)	14.74 (0.580)	15.74 (0.620)	18.9 (0.744)
63	CH88	11.1 (0.437)	38.2 (1.504)	14.74 (0.580)	15.74 (0.620)	18.9 (0.744)
65	CH89	14.8 (0.583)	38.2 (1.504)	14.74 (0.580)	15.74 (0.620)	18.9 (0.744)
67	CH91	3.80 (0.150)	40.6 (1.598)	19.52 (0.769)	21.12 (0.831)	24.0 (0.945)
69	CH92	7.40 (0.291)	40.6 (1.598)	19.52 (0.769)	21.12 (0.831)	24.0 (0.945)
71	CH93	11.1 (0.437)	40.6 (1.598)	19.52 (0.769)	21.12 (0.831)	24.0 (0.945)
73	CH94	14.8 (0.583)	40.6 (1.598)	19.52 (0.769)	21.12 (0.831)	24.0 (0.945)

ESCC DETAIL SPECIFICATION NO. 3001/030 PHYSICAL DIMENSIONS – CH STYLE, L

Millimeters (Inches)

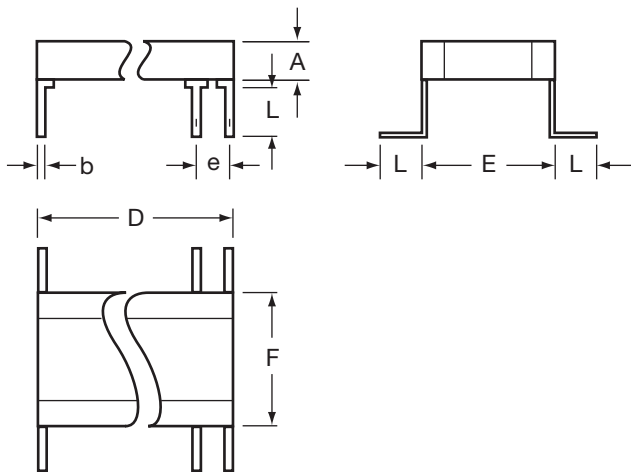

Symbol	Min.	Max.	Notes
b	0.45 (0.018)	0.55 (0.022)	1
e	2.49 (0.098)	2.59 (0.102)	2
L	2.04 (0.080)	3.04 (0.120)	1

Notes: 1 – All leads
2 – Each space

Variant	Case Size	A	D	E		F
		Max.	Max.	Min.	Max.	Max.
08	CH41	3.80 (0.150)	8.70 (0.343)	7.70 (0.303)	8.70 (0.343)	9.20 (0.362)
10	CH42	7.40 (0.291)	8.70 (0.343)	7.70 (0.303)	8.70 (0.343)	9.20 (0.362)
12	CH43	11.1 (0.437)	8.70 (0.343)	7.70 (0.303)	8.70 (0.343)	9.20 (0.362)
14	CH44	14.8 (0.583)	8.70 (0.343)	7.70 (0.303)	8.70 (0.343)	9.20 (0.362)
17	CH51	3.80 (0.150)	10.7 (0.421)	9.66 (0.380)	10.66 (0.420)	10.7 (0.421)
19	CH52	7.40 (0.291)	10.7 (0.421)	9.66 (0.380)	10.66 (0.420)	10.7 (0.421)
21	CH53	11.1 (0.437)	10.7 (0.421)	9.66 (0.380)	10.66 (0.420)	10.7 (0.421)
23	CH54	14.8 (0.583)	10.7 (0.421)	9.66 (0.380)	10.66 (0.420)	10.7 (0.421)
26	CH61	3.80 (0.150)	13.6 (0.535)	13.5 (0.531)	14.5 (0.571)	14.9 (0.587)
28	CH62	7.40 (0.291)	13.6 (0.535)	13.5 (0.531)	14.5 (0.571)	14.9 (0.587)
30	CH63	11.1 (0.437)	13.6 (0.535)	13.5 (0.531)	14.5 (0.571)	14.9 (0.587)
32	CH64	14.8 (0.583)	13.6 (0.535)	13.5 (0.531)	14.5 (0.571)	14.9 (0.587)
35	CH71	3.80 (0.150)	21.6 (0.850)	14.74 (0.580)	15.74 (0.620)	16.8 (0.661)
37	CH72	7.40 (0.291)	21.6 (0.850)	14.74 (0.580)	15.74 (0.620)	16.8 (0.661)
39	CH73	11.1 (0.437)	21.6 (0.850)	14.74 (0.580)	15.74 (0.620)	16.8 (0.661)
41	CH74	14.8 (0.583)	21.6 (0.850)	14.74 (0.580)	15.74 (0.620)	16.8 (0.661)
44	CH76	3.80 (0.150)	16.6 (0.654)	19.52 (0.769)	21.12 (0.831)	21.6 (0.850)
46	CH77	7.40 (0.291)	16.6 (0.654)	19.52 (0.769)	21.12 (0.831)	21.6 (0.850)
48	CH78	11.1 (0.437)	16.6 (0.654)	19.52 (0.769)	21.12 (0.831)	21.6 (0.850)
50	CH79	14.8 (0.583)	16.6 (0.654)	19.52 (0.769)	21.12 (0.831)	21.6 (0.850)
52	CH81	3.80 (0.150)	38.2 (1.504)	9.66 (0.380)	10.66 (0.420)	12.0 (0.472)
54	CH82	7.40 (0.291)	38.2 (1.504)	9.66 (0.380)	10.66 (0.420)	12.0 (0.472)
56	CH83	11.1 (0.437)	38.2 (1.504)	9.66 (0.380)	10.66 (0.420)	12.0 (0.472)
58	CH84	14.8 (0.583)	38.2 (1.504)	9.66 (0.380)	10.66 (0.420)	12.0 (0.472)
60	CH86	3.80 (0.150)	38.2 (1.504)	14.74 (0.580)	15.74 (0.620)	18.9 (0.744)
62	CH87	7.40 (0.291)	38.2 (1.504)	14.74 (0.580)	15.74 (0.620)	18.9 (0.744)
64	CH88	11.1 (0.437)	38.2 (1.504)	14.74 (0.580)	15.74 (0.620)	18.9 (0.744)
66	CH89	14.8 (0.583)	38.2 (1.504)	14.74 (0.580)	15.74 (0.620)	18.9 (0.744)
68	CH91	3.80 (0.150)	40.6 (1.598)	19.52 (0.769)	21.12 (0.831)	24.0 (0.945)
70	CH92	7.40 (0.291)	40.6 (1.598)	19.52 (0.769)	21.12 (0.831)	24.0 (0.945)
72	CH93	11.1 (0.437)	40.6 (1.598)	19.52 (0.769)	21.12 (0.831)	24.0 (0.945)
74	CH94	14.8 (0.583)	40.6 (1.598)	19.52 (0.769)	21.12 (0.831)	24.0 (0.945)

COG Dielectric General Specifications

Capacitance Range
100 pF to 1.2 μ F
(25°C, 1.0 \pm 0.2 Vrms (open circuit voltage)
at 1 KHz, for \leq 100 pF use 1 MHz)

Capacitance Tolerances
 \pm 5%, \pm 10%, \pm 20%

Operating Temperature Range
-55°C to +125°C

Temperature Characteristic
0 \pm 30 ppm/°C

Voltage Ratings
1000 VDC thru 5000 VDC (+125°C)

Dissipation Factor
0.15% max.
(25°C, 1.0 \pm 0.2 Vrms (open circuit voltage)
at 1 KHz, for \leq 100 pF use 1 MHz)

Insulation Resistance (+25°C, at 500V)
100K M Ω min., or 1000 M Ω - μ F min.,
whichever is less

Insulation Resistance (+125°C, at 500V)
10K M Ω min., or 100 M Ω - μ F min.,
whichever is less

Dielectric Strength
120% rated voltage, 5 seconds

Life Test
100% rated and +125°C

N1500 General Specifications

Capacitance Range
100 pF to 1.9 μ F
(25°C, 1.0 \pm 0.2 Vrms (open circuit voltage)
at 1 KHz)

Capacitance Tolerances
 \pm 5%, \pm 10%, \pm 20%

Operating Temperature Range
-55°C to +125°C

Temperature Characteristic
-1500 \pm 250 ppm/°C

Voltage Ratings
1000 VDC thru 5000 VDC (+125°C)

Dissipation Factor
0.15% max.
(25°C, 1.0 \pm 0.2 Vrms (open circuit voltage)
at 1 KHz)

Insulation Resistance (+25°C, at 500V)
100K M Ω min., or 1000 M Ω - μ F min.,
whichever is less

Insulation Resistance (+125°C, at 500V)
10K M Ω min., or 100 M Ω - μ F min.,
whichever is less

Dielectric Strength
120% rated voltage, 5 seconds

Life Test
100% rated and +125°C

X7R Dielectric General Specifications

Capacitance Range
100 pF to 15 μ F
(25°C, 1.0 \pm 0.2 Vrms (open circuit voltage)
at 1 KHz)

Capacitance Tolerances
 \pm 10%, \pm 20%, +80%, -20%

Operating Temperature Range
-55°C to +125°C

Temperature Characteristic
 \pm 15% (0 VDC)

Voltage Ratings
1000 VDC thru 5000 VDC (+125°C)

Dissipation Factor
2.5% max.
(25°C, 1.0 \pm 0.2 Vrms (open circuit voltage)
at 1 KHz)

Insulation Resistance (+25°C, at 500V)
100K M Ω min., or 1000 M Ω - μ F min.,
whichever is less

Insulation Resistance (+125°C, at 500V)
10K M Ω min., or 100 M Ω - μ F min.,
whichever is less

Dielectric Strength
120% rated voltage, 5 seconds

Life Test
100% rated and +125°C

HOW TO ORDER

AVX Styles: HV01 THRU HV06

HV	01	A	C	105	M	A	N	650
AVX Style	Size See Dimensions chart	Voltage 1K = A 2K = G 3K = H 4K = J 5K = K	Temperature Coefficient COG = A X7R = C N1500 = 4	Capacitance Code (2 significant digits + number of zeros) 10 pF = 100 100 pF = 101 1,000 pF = 102 22,000 pF = 223 220,000 pF = 224 1 μ F = 105 10 μ F = 106 100 μ F = 107	Capacitance Tolerance COG: J = \pm 5% K = \pm 10% M = \pm 20% X7R: K = \pm 10% M = \pm 20% Z = +80%, -20% N1500: J = \pm 5% K = \pm 10% M = \pm 20%	Test Level A = Does not apply	Termination N = Straight Lead J = Leads formed in L = Leads formed out P = P Style Leads Z = Z Style Leads	Height Max Dimension "A" 120 = 0.120" 240 = 0.240" 360 = 0.360" 480 = 0.480" 650 = 0.650"

Note: Capacitors with X7R dielectrics are not intended for applications across AC supply mains or AC line filtering with polarity reversal. Contact plant for recommendations.

High Voltage DIP Ledged (HV Style)



Surface Mount and Thru-Hole HV Styles

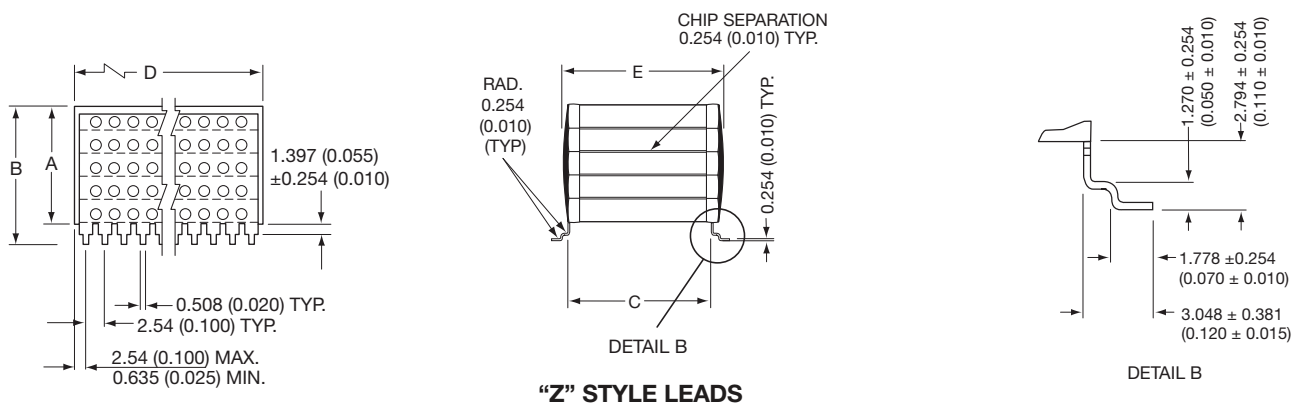
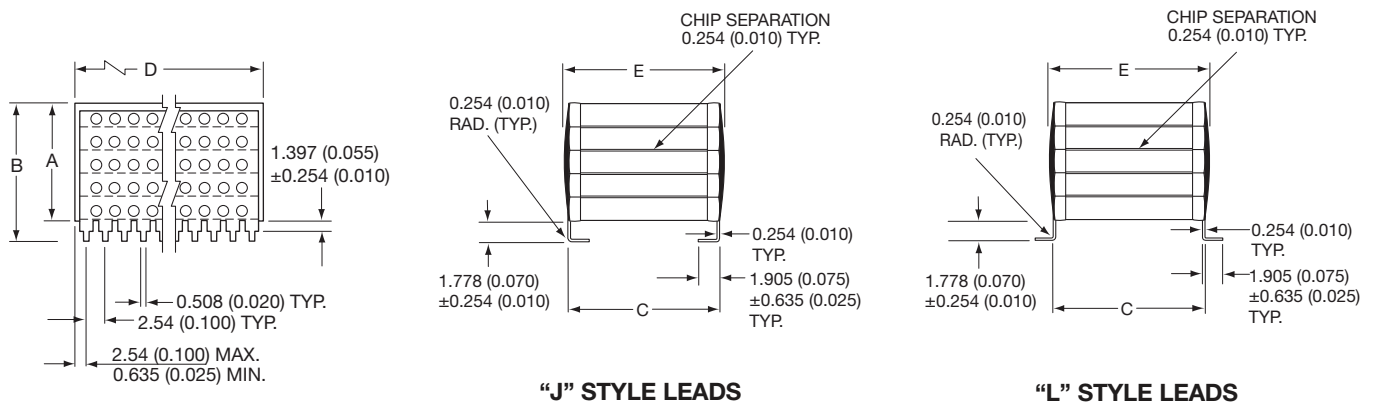
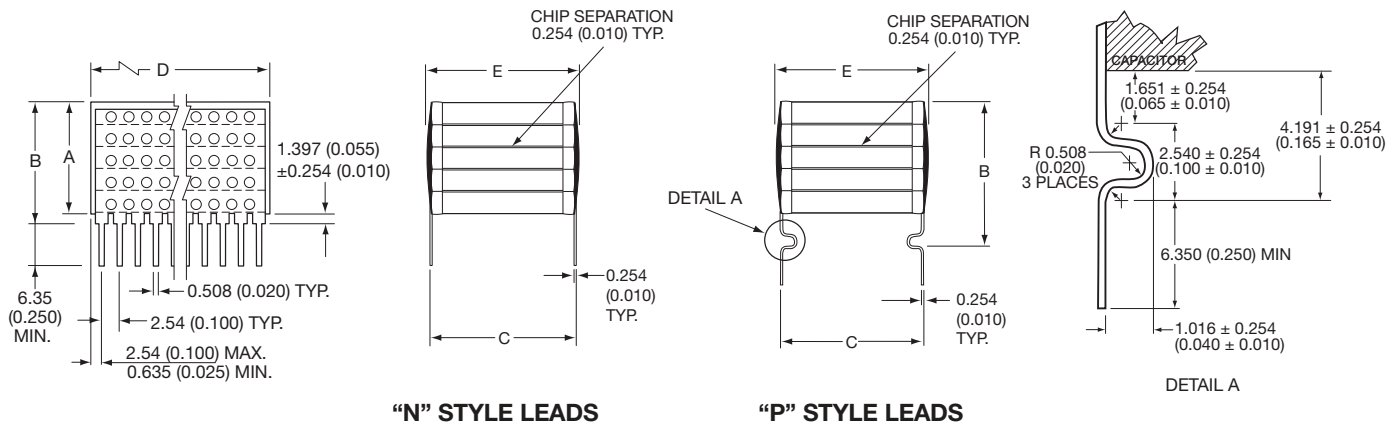

DIMENSIONS

millimeters (inches)

Style	A (max.)	B (max.)	C ±.635 (±0.025)	D ±.635 (±0.025)	E (max.)	No. of Leads per side
HV01	See page 69 for maximum "A" Dimension	For "N" Style Leads: "A" Dimension Plus 1.651 (0.065) For "J" & "L" Style Leads: "A" Dimension Plus 2.032 (0.080) For "P" Style Leads: "A" Dimension Plus 4.445 (0.175) For "Z" Style Leads: "A" Dimension Plus 3.048 (0.120)	53.3 (2.100)	10.5 (0.415)	54.9 (2.160)	4
HV02			39.1 (1.540)	20.3 (0.800)	40.7 (1.600)	8
HV03			27.2 (1.070)	10.5 (0.415)	28.2 (1.130)	4
HV04			10.2 (0.400)	10.2 (0.400)	11.2 (0.440)	4
HV05			6.35 (0.250)	6.35 (0.250)	7.62 (0.300)	3
HV06			53.3 (2.100)	29.0 (1.140)	54.9 (2.160)	11



High Voltage DIP Ledged (HV Style)



Surface Mount and Thru-Hole HV Styles

Max Capacitance (µF) Available Versus Style with Height (A) of 0.120" - 3.05mm

AVX STYLE	HV01 _____ AN120					HV02 _____ AN120					HV03 _____ AN120					HV04 _____ AN120					HV05 _____ AN120		HV06 _____ AN120				
	1KV	2KV	3KV	4KV	5KV	1KV	2KV	3KV	4KV	5KV	1KV	2KV	3KV	4KV	5KV	1KV	2KV	3KV	4KV	5KV	1KV	2KV	1KV	2KV	3KV	4KV	5KV
COG	.086	.024	.011	.0062	.0052	.120	.034	.015	.0088	.0074	.042	.013	.0058	.0030	.0024	.012	.0040	.0018	.0009	.0007	.0048	.0013	.240	.066	.028	.018	.015
N1500	.140	.042	.018	.010	.0084	.200	.058	.024	.014	.012	.068	.020	.0090	.0050	.0040	.020	.0066	.0028	.0014	.0012	.0078	.0022	.380	.100	.046	.030	.026
X7R	1.10	.260	.150	.066	.052	1.50	.360	.200	.094	.078	.520	.130	.072	.032	.024	.160	.042	---	---	---	.060	---	3.00	.700	.440	.200	.170

Max Capacitance (µF) Available Versus Style with Height (A) of 0.240" - 6.10mm

AVX STYLE	HV01 _____ AN240					HV02 _____ AN240					HV03 _____ AN240					HV04 _____ AN240					HV05 _____ AN240		HV06 _____ AN240				
	1KV	2KV	3KV	4KV	5KV	1KV	2KV	3KV	4KV	5KV	1KV	2KV	3KV	4KV	5KV	1KV	2KV	3KV	4KV	5KV	1KV	2KV	1KV	2KV	3KV	4KV	5KV
COG	.170	.048	.022	.012	.010	.240	.068	.031	.017	.015	.084	.026	.011	.0060	.0048	.025	.0082	.0036	.0018	.0014	.0096	.0027	.480	.130	.056	.036	.031
N1500	.280	.084	.036	.020	.016	.400	.110	.048	.028	.024	.130	.040	.018	.010	.0080	.040	.013	.0056	.0028	.0025	.015	.0044	.760	.210	.092	.060	.052
X7R	2.20	.520	.300	.130	.100	3.10	.720	.400	.180	.150	1.00	.270	.140	.064	.048	.330	.084	---	---	---	.120	---	6.00	1.40	.880	.400	.340

Max Capacitance (µF) Available Versus Style with Height (A) of 0.360" - 9.15mm

AVX STYLE	HV01 _____ AN360					HV02 _____ AN360					HV03 _____ AN360					HV04 _____ AN360					HV05 _____ AN360		HV06 _____ AN360				
	1KV	2KV	3KV	4KV	5KV	1KV	2KV	3KV	4KV	5KV	1KV	2KV	3KV	4KV	5KV	1KV	2KV	3KV	4KV	5KV	1KV	2KV	1KV	2KV	3KV	4KV	5KV
COG	.250	.072	.033	.018	.015	.360	.100	.047	.026	.022	.120	.039	.017	.0090	.0072	.038	.012	.0054	.0027	.0022	.014	.0040	.720	.200	.084	.055	.047
N1500	.420	.120	.055	.030	.025	.600	.170	.072	.043	.036	.200	.060	.027	.015	.012	.060	.020	.0084	.0043	.0037	.023	.0066	1.10	.310	.130	.090	.078
X7R	3.30	.780	.450	.200	.150	4.70	1.00	.600	.280	.230	1.50	.410	.210	.096	.072	.490	.120	---	---	---	.180	---	9.00	2.10	1.30	.600	.510

Max Capacitance (µF) Available Versus Style with Height (A) of 0.480" - 12.2mm

AVX STYLE	HV01 _____ AN480					HV02 _____ AN480					HV03 _____ AN480					HV04 _____ AN480					HV05 _____ AN480		HV06 _____ AN480				
	1KV	2KV	3KV	4KV	5KV	1KV	2KV	3KV	4KV	5KV	1KV	2KV	3KV	4KV	5KV	1KV	2KV	3KV	4KV	5KV	1KV	2KV	1KV	2KV	3KV	4KV	5KV
COG	.340	.096	.044	.024	.020	.480	.130	.063	.035	.030	.160	.052	.023	.012	.0096	.051	.016	.0072	.0036	.0029	.019	.0054	.960	.260	.110	.073	.062
N1500	.560	.160	.073	.040	.033	.800	.230	.096	.057	.048	.270	.080	.036	.020	.016	.080	.026	.011	.0057	.0050	.031	.0088	1.50	.420	.180	.120	.100
X7R	4.40	1.00	.600	.260	.200	6.30	1.40	.800	.370	.310	2.00	.550	.280	.120	.096	.650	.160	---	---	---	.240	---	12.0	2.80	1.70	.800	.68

Max Capacitance (µF) Available Versus Style with Height (A) of 0.650" - 16.5mm

AVX STYLE	HV01 _____ AN650					HV02 _____ AN650					HV03 _____ AN650					HV04 _____ AN650					HV05 _____ AN650		HV06 _____ AN650				
	1KV	2KV	3KV	4KV	5KV	1KV	2KV	3KV	4KV	5KV	1KV	2KV	3KV	4KV	5KV	1KV	2KV	3KV	4KV	5KV	1KV	2KV	1KV	2KV	3KV	4KV	5KV
COG	.430	.120	.056	.031	.026	.610	.170	.079	.044	.037	.210	.065	.029	.015	.012	.064	.020	.009	.0045	.0037	.024	.0068	1.20	.330	.140	.092	.078
N1500	.700	.210	.092	.050	.042	1.00	.290	.120	.072	.060	.340	.100	.045	.025	.020	.100	.033	.014	.0072	.0063	.039	.011	1.90	.530	.230	.150	.130
X7R	5.50	1.30	.750	.330	.260	7.90	1.80	1.00	.470	.390	2.60	.690	.360	.160	.120	.820	.210	---	---	---	.300	---	15.0	3.50	2.20	1.00	.850

High Voltage Leded (CH Style)



Radial, Dual-in-Line & 'L' Lead SMT

330 pF to 2.7 μ F
 1kV to 5kV
 -55°C to +125°C
 1B/COG and 2C1/X7R Dielectrics

This range of radial, dual-in-line for both through hole and surface mount products is intended for use in high voltage power supplies and voltage multiplier circuits. The multilayer ceramic construction offers excellent volumetric efficiency compared with other high voltage dielectrics. They are suitable for both high reliability and industrial applications.

ELECTRICAL SPECIFICATIONS

Temperature Coefficient CECC 30 000, (4.24.1)
 1B/COG: A Temperature Coefficient - 0 ± 30 ppm/°C
 2C1/X7R: C Temperature Characteristic - $\pm 15\%$ (0v cd)

Capacitance Test 25°C
 1B/COG: Measured at 1 VRMS max at 1KHz (1MHz <100 pF)
 2C1/X7R: Measured at 1 VRMS max at 1KHz

Dissipation Factor 25°C
 1B/COG: 0.15% max at 1KHz, 1 VRMS (1MHz for <100 pF)
 2C1/X7R: 2.5% max at 1KHz, 1 VRMS

Insulation Resistance
 1B/COG & 2C1/X7R: 100K megohms or 1000 megohms- μ F, whichever is less

Dielectric Withstanding Voltage 25°C
 130% rated voltage for 5 seconds

Life Test (1000 hrs) CECC 30000 (4.23)
 1B/COG & 2C1/X7R: 120% rated voltage at +125°C.

Aging
 1B/COG: Zero
 2C1/X7R: 2.5%/decade hour

DUAL-IN-LINE

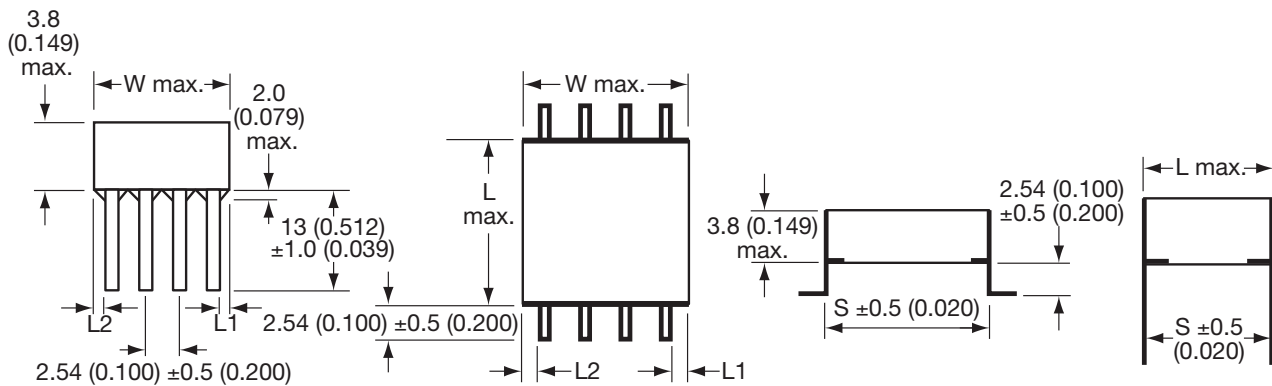

DIMENSIONS

millimeters (inches)

Style	L (max)	W (max)	S (nom)	No. of Leads per side
CH41	9.2 (0.362)	8.7 (0.342)	8.2 (0.323)	3
CH51	10.7 (0.421)	10.7 (0.421)	10.2 (0.400)	4
CH61	14.9 (0.587)	13.6 (0.535)	14.0 (0.551)	5
CH76	21.6 (0.850)	16.6 (0.654)	20.3* (0.800)	6
CH91	24.0 (0.944)	40.6 (1.598)	20.3* (0.800)	14

Lead width 0.5 (0.020)
 Lead thickness 0.254 (0.010)
 $L1 = L2 \pm 0.5 (0.020)$

*Tolerance ± 0.8

HOW TO ORDER

CH	41	A	C	104	K	A	8	0	A	7
Style Code	Size Code	Voltage Code	Dielectric Code	Capacitance Code	Capacitance Tolerance	Specification Code	Finish Code	Lead Dia. Code	Lead Space Code	Lead Style Code
	A = 1kV G = 2kV H = 3kV J = 4kV K = 5kV	A = COG C = X7R	(2 significant digits + no. of zeros) eg. 105 = 1 μ F 106 = 10 μ F 107 = 100 μ F	COG: J = $\pm 5\%$ K = $\pm 10\%$ M = $\pm 20\%$ X7R: K = $\pm 10\%$ M = $\pm 20\%$ P = +100, -0%	A = Non customized 8 = Varnish	0 = Standard A = Standard	0 = Dual in line straight 7 = Dual in line 'L' style			



High Voltage Leaded (CV Style)



Chip Assemblies

VERTICALLY MOUNTED RADIAL PRODUCT

Part Number format (CVxxxxxxxxxxA2)

Typical Part Number CV51AC154MA80A2

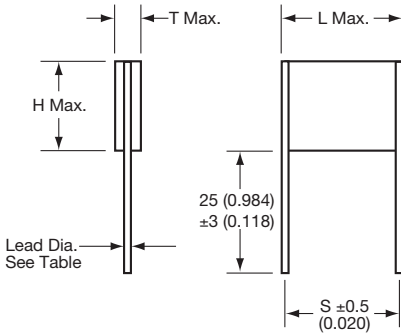

DIMENSIONS

millimeters (inches)

Style	L (max)	H (max)	T (max)	S (nom)	Lead Dia (nom)
CV41	10.6 (0.417)	8.70 (0.343)	3.80 (0.150)	8.20 (0.323)	0.70 (0.028)
CV51	11.9 (0.469)	10.7 (0.421)	3.80 (0.150)	10.2 (0.402)	0.90 (0.035)
CV61	16.5 (0.650)	13.6 (0.536)	3.80 (0.150)	15.2 (0.599)	0.90 (0.035)
CV76	22.7 (0.893)	16.6 (0.654)	3.80 (0.150)	21.2* (0.835)	0.90 (0.035)
CV91	22.7 (0.893)	40.6 (1.598)	3.80 (0.150)	21.2* (0.835)	1.20 (0.047)

*Tolerance $\pm 0.8\text{mm}$ (0.031)

HOW TO ORDER

CV

Style Code

51

Size Code

A

Voltage Code

A = 1kV
G = 2kV
H = 3kV
J = 4kV
K = 5kV

C

Dielectric Code

A = COG
C = X7R

154

Capacitance Code

(2 significant digits + no. of zeros)
eg. 105 = 1 μF
106 = 10 μF
107 = 100 μF

M

Capacitance Tolerance

COG: J = $\pm 5\%$
K = $\pm 10\%$
M = $\pm 20\%$
X7R: K = $\pm 10\%$
M = $\pm 20\%$
P = +100, -0%

A

Specification Code

A = Non customized

8

Finish Code

8 = Varnish

0

Lead Dia. Code

0 = Standard

A

Lead Space Code

A = Standard

2

Lead Style Code

High Voltage Leaded (CH/CV Style)



Chip Assemblies

1B/C0G ULTRA STABLE CERAMIC

	CV41-CH41 Styles				CV51-CH51 Styles				CV61-CH61 Styles				CV76-CH76 Styles				CV91-CH91 Styles			
Cap pF																				
330				K																
390			J	K																
470			J	K																
560			J	K																
680			J					K												
820		H	J					K												
1000		H					J	K												
1200		H					J	K												
1500		H					J					K								
1800	G				H	J						K								
2200	G				H				J	K										
2700	G				H				J						K					
3300	G				G				H	J					K					
3900	G				G				H				J	K						
4700	G				G				H				J	K						
5600	A				G				H				J							K
6800	A				G			G					H	J						K
8200	A				G			G					H						J	K
10000	A				G			G					H						J	K
12000	A			A				G					H						J	K
15000	A			A				G				G					H	J		
18000				A				G				G					H	J		
22000				A			A					G					H			
27000				A			A					G					H			
33000				A			A					G					H			
39000							A					G					G			
47000							A					A					G			
56000							A					A					G			
68000							A					A					G			
82000												A					G			
100000												A					G			
120000																	A			
150000																	A			
180000																	A			
220000																	A			
270000																	A			
330000																	A			

NB Figures in cells refer to size within ordering information

High Voltage Leaded (CH/CV Style)



Chip Assemblies

2C1/X7R STABLE CERAMIC

Cap nF	CV41-CH41 Styles			CV51-CH51 Styles			CV61-CH61 Styles			CV76-CH76 Styles			CV91-CH91 Styles		
1.2															
1.3															
1.5															
2.2															
2.7															
3.3															
3.9															
4.7															
5.6															
6.8															
8.2															
10															
12															
15															
18															
22															
27															
33															
39															
47															
56															
68															
82															
100															
120															
150															
180															
220															
270															
330															
390															
470															
560															
680															
820															
1000															
1200															
1500															
1800															
2200															
2700															

NB Figures in cells refer to size within ordering information

High Voltage MLC Radials (SV Style)



Application Information on High Voltage MLC Capacitors

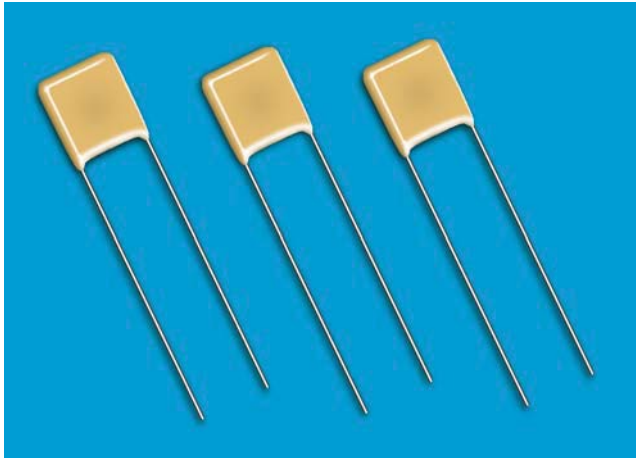

High value, low leakage and small size are difficult parameters to obtain in capacitors for high voltage systems. AVX special high voltage MLC radial leaded capacitors meet these performance characteristics. The added advantage of these capacitors lies in special internal design minimizing the electric field stresses within the MLC. These special design criteria result in significant reduction of partial discharge activity within the dielectric and having, therefore, a major impact on long-term reliability of the product. The SV high voltage radial capacitors are conformally coated with high insulation resistance, high dielectric strength epoxy eliminating the possibility of arc flashover.

The SV high voltage radial MLC designs exhibit low ESRs at high frequency. The same criteria governing the high voltage design carries the added benefits of extremely low ESR in relatively low capacitance and small packages. These capacitors are designed and are ideally suited for applications such as snubbers in high frequency power converters, resonators in SMPS, and high voltage coupling/DC blocking.

COG Dielectric General Specifications

Capacitance Range

10 pF to .15 μ F
(+25°C, 1.0 \pm 0.2 Vrms at 1kHz,
for \leq 100 pF use 1 MHz)

Capacitance Tolerances

\pm 5%; \pm 10%; \pm 20%

Operating Temperature Range

-55°C to +125°C

Temperature Characteristic

0 \pm 30 ppm/°C

Voltage Ratings

600 VDC thru 5000 VDC (+125°C)

Dissipation Factor

0.15% max.
(+25°C, 1.0 \pm 0.2 Vrms at 1kHz,
for \leq 100 pF use 1 MHz)

Insulation Resistance (+25°C, at 500V)

100K M Ω min. or 1000 M Ω - μ F min.,
whichever is less

Insulation Resistance (+125°C, at 500V)

10K M Ω min., or 100 M Ω - μ F min.,
whichever is less

Dielectric Strength

120% rated voltage, 5 seconds

Life Test

100% rated and +125°C

X7R Dielectric General Specifications

Capacitance Range

100 pF to 2.2 μ F
(+25°C, 1.0 \pm 0.2 Vrms at 1kHz)

Capacitance Tolerances

\pm 10%; \pm 20%; +80%, -20%

Operating Temperature Range

-55°C to +125°C

Temperature Characteristic

\pm 15% (0 VDC)

Voltage Ratings

600 VDC thru 5000 VDC (+125°C)

Dissipation Factor

2.5% max.
(+25°C, 1.0 \pm 0.2 Vrms at 1kHz)

Insulation Resistance (+25°C, at 500V)

100K M Ω min., or 1000 M Ω - μ F min.,
whichever is less

Insulation Resistance (+125°C, at 500V)

10K M Ω min., or 100 M Ω - μ F min.,
whichever is less

Dielectric Strength

120% rated voltage, 5 seconds

Life Test

100% rated and +125°C

High Voltage MLC Radials (SV Style)

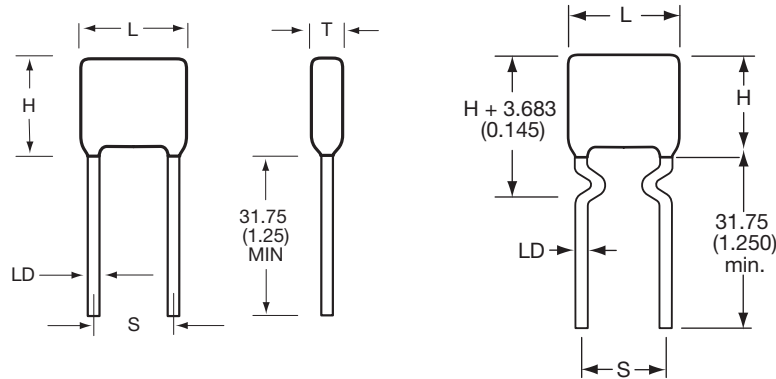

SV01 thru SV17

SV52 thru SV59 and SV63 thru SV67

HIGH VOLTAGE RADIAL LEAD HOW TO ORDER

AVX Styles: SV01 THRU SV67

SV01	A	A	102	K	A	A	*
AVX Style	Voltage	Temperature Coefficient	Capacitance Code	Capacitance Tolerance	Test Level	Leads	Packaging
	600V/630V = C 1000V = A 1500V = S 2000V = G 2500V = W 3000V = H 4000V = J 5000V = K	COG = A X7R = C	(2 significant digits + no. of zeros) Examples: 10 pF = 100 100 pF = 101 1,000 pF = 102 22,000 pF = 223 220,000 pF = 224 1 μF = 105	COG: J = ±5% K = ±10% M = ±20% X7R: K = ±10% M = ±20% Z = +80 -20%	A = Standard B = Hi-Rel*	A = Tin/Lead R = RoHS Compliant	(See Note 1)
<p>Note 1: No suffix signifies bulk packaging which is AVX standard packaging. Use suffix "TR1" if tape and reel is required. Parts are reel packaged per EIA-468.</p>							

Note: Capacitors with X7R dielectrics are not intended for applications across AC supply mains or AC line filtering with polarity reversal. Contact plant for recommendations. *Hi-Rel screening consists of 100% Group A, Subgroup 1 per MIL-PRF-49467. (Except partial discharge testing is not performed and DWV is at 120% rated voltage).

DIMENSIONS

millimeters (inches)

AVX Style	Length (L) max	Height (H) max	Thickness (T) max	Lead Spacing ±.762 (.030) (S)	LD (Nom)
SV01	6.35 (0.250)	5.59 (0.220)	5.08 (0.200)	4.32 (0.170)	0.64 (0.025)
SV02/SV52	8.13 (0.320)	7.11 (0.280)	5.08 (0.200)	5.59 (0.220)	0.64 (0.025)
SV03/SV53	9.40 (0.370)	7.62 (0.300)	5.08 (0.200)	6.99 (0.275)	0.64 (0.025)
SV04/SV54	11.4 (0.450)	5.59 (0.220)	5.08 (0.200)	7.62 (0.300)	0.64 (0.025)
SV05/SV55	11.9 (0.470)	10.2 (0.400)	5.08 (0.200)	9.52 (0.375)	0.64 (0.025)
SV06/SV56	14.0 (0.550)	7.11 (0.280)	5.08 (0.200)	10.16 (0.400)	0.64 (0.025)
SV07/SV57	14.5 (0.570)	12.7 (0.500)	5.08 (0.200)	12.1 (0.475)	0.64 (0.025)
SV08/SV58	17.0 (0.670)	15.2 (0.600)	5.08 (0.200)	14.6 (0.575)	0.64 (0.025)
SV09/SV59	19.6 (0.770)	18.3 (0.720)	5.08 (0.200)	17.1 (0.675)	0.64 (0.025)
SV10	26.7 (1.050)	12.7 (0.500)	5.08 (0.200)	22.9 (0.900)	0.64 (0.025)
SV11	31.8 (1.250)	15.2 (0.600)	5.08 (0.200)	27.9 (1.100)	0.64 (0.025)
SV12	36.8 (1.450)	18.3 (0.720)	5.08 (0.200)	33.0 (1.300)	0.64 (0.025)
SV13/SV63	7.62 (0.300)	9.14 (0.360)	5.08 (0.200)	5.08 (0.200)	0.51 (0.020)
SV14/SV64	10.2 (0.400)	11.7 (0.460)	5.08 (0.200)	5.08 (0.200)	0.51 (0.020)
SV15/SV65	12.7 (0.500)	14.2 (0.560)	5.08 (0.200)	10.2 (0.400)	0.64 (0.025)
SV16/SV66	22.1 (0.870)	16.8 (0.660)	5.08 (0.200)	20.1 (0.790)	0.81 (0.032)
SV17/SV67	23.6 (0.930)	19.8 (0.780)	6.35 (0.250)	20.3 (0.800)	0.81 (0.032)

TAPE & REEL QUANTITY	
Part	Pieces
SV01	1000
SV02/SV52	1000
SV03/SV53	1000
SV04/SV54	1000
SV05/SV55	1000
SV06/SV56	500
SV07/SV57	500
SV08/SV58	500
SV09/SV59	500
SV10	N/A
SV11	N/A
SV12	N/A
SV13/SV63	1000
SV14/SV64	1000
SV15/SV65	500
SV16/SV66	500
SV17/SV67	400

RoHS	
Part	Available
SV01	Yes
SV02/SV52	Yes
SV03/SV53	Yes
SV04/SV54	Yes
SV05/SV55	Yes
SV06/SV56	Yes
SV07/SV57	Yes
SV08/SV58	Yes
SV09/SV59	Yes
SV10	Yes
SV11	Yes
SV12	Yes
SV13/SV63	Yes
SV14/SV64	Yes
SV15/SV65	Yes
SV16/SV66	Yes
SV17/SV67	Yes



High Voltage MLC Radials (SV Style)



CAPACITANCE VALUE

C0G								
Style	600/630V min./max.	1000V min./max.	1500V min./max.	2000V min./max.	2500V min./max.	3000V min./max.	4000V min./max.	5000V min./max.
SV01	100 pF / 1500 pF	100 pF / 1000 pF	10 pF / 330 pF	10 pF / 220 pF	10 pF / 120 pF	10 pF / 82 pF	—	—
SV02/SV52	100 pF / 6800 pF	100 pF / 4700 pF	100 pF / 1500 pF	10 pF / 1000 pF	10 pF / 680 pF	10 pF / 560 pF	10 pF / 150 pF	10 pF / 100 pF
SV03/SV53	100 pF / 0.012 μF	100 pF / 8200 pF	100 pF / 2700 pF	100 pF / 1800 pF	10 pF / 1000 pF	10 pF / 680 pF	10 pF / 390 pF	10 pF / 220 pF
SV04/SV54	100 pF / 3900 pF	100 pF / 2700 pF	10 pF / 820 pF	10 pF / 560 pF	10 pF / 270 pF	10 pF / 180 pF	10 pF / 100 pF	10 pF / 68 pF
SV05/SV55	1000 pF / 0.027 μF	1000 pF / 0.018 μF	100 pF / 6800 pF	100 pF / 4700 pF	100 pF / 2700 pF	100 pF / 1500 pF	10 pF / 1000 pF	10 pF / 560 pF
SV06/SV56	100 pF / 0.012 μF	100 pF / 0.010 μF	100 pF / 3300 pF	100 pF / 2200 pF	10 pF / 1200 pF	10 pF / 820 pF	10 pF / 470 pF	10 pF / 390 pF
SV07/SV57	1000 pF / 0.056 μF	1000 pF / 0.033 μF	1000 pF / 0.015 μF	100 pF / 0.010 μF	100 pF / 5600 pF	100 pF / 3900 pF	100 pF / 2200 pF	10 pF / 1200 pF
SV08/SV58	1000 pF / 0.082 μF	1000 pF / 0.047 μF	1000 pF / 0.022 μF	1000 pF / 0.015 μF	100 pF / 0.010 μF	100 pF / 6800 pF	100 pF / 3300 pF	100 pF / 2200 pF
SV09/SV59	1000 pF / 0.150 μF	1000 pF / 0.082 μF	1000 pF / 0.039 μF	1000 pF / 0.022 μF	1000 pF / 0.015 μF	100 pF / 8200 pF	100 pF / 4700 pF	100 pF / 3300 pF
SV10	1000 pF / 0.100 μF	1000 pF / 0.056 μF	1000 pF / 0.022 μF	1000 pF / 0.012 μF	100 pF / 8200 pF	100 pF / 5600 pF	100 pF / 3300 pF	100 pF / 2200 pF
SV11	1000 pF / 0.150 μF	1000 pF / 0.082 μF	1000 pF / 0.039 μF	1000 pF / 0.022 μF	1000 pF / 0.015 μF	100 pF / 8200 pF	100 pF / 4700 pF	100 pF / 3300 pF
SV12	0.01 μF / 0.220 μF	0.01 μF / 0.15 μF	1000 pF / 0.056 μF	1000 pF / 0.033 μF	1000 pF / 0.022 μF	1000 pF / 0.015 μF	100 pF / 8200 pF	100 pF / 5600 pF
SV13/SV63	100 pF / 0.018 μF	100 pF / 0.012 μF	100 pF / 4700 pF	100 pF / 2700 pF	100 pF / 1800 pF	100 pF / 1000 pF	10 pF / 470 pF	10 pF / 390 pF
SV14/SV64	1000 pF / 0.039 μF	1000 pF / 0.022 μF	100 pF / 8200 pF	100 pF / 5600 pF	100 pF / 3300 pF	100 pF / 1800 pF	10 pF / 820 pF	10 pF / 680 pF
SV15/SV65	1000 pF / 0.056 μF	1000 pF / 0.033 μF	1000 pF / 0.015 μF	100 pF / 0.01 μF	100 pF / 5600 pF	100 pF / 3900 pF	100 pF / 2200 pF	100 pF / 1200 pF
SV16/SV66	1000 pF / 0.120 μF	1000 pF / 0.082 μF	1000 pF / 0.039 μF	1000 pF / 0.027 μF	1000 pF / 0.015 μF	100 pF / 8200 pF	100 pF / 4700 pF	100 pF / 3300 pF
SV17/SV67	1000 pF / 0.150 μF	1000 pF / 0.10 μF	1000 pF / 0.056 μF	1000 pF / 0.039 μF	1000 pF / 0.022 μF	1000 pF / 0.012 μF	100 pF / 6800 pF	100 pF / 4700 pF
X7R								
SV01	1000 pF / 0.018 μF	1000 pF / 0.012 μF	100 pF / 5600 pF	100 pF / 3900 pF	—	—	—	—
SV02/SV52	1000 pF / 0.082 μF	1000 pF / 0.047 μF	1000 pF / 0.015 μF	100 pF / 6800 pF	100 pF / 3900 pF	100 pF / 2700 pF	—	—
SV03/SV53	1000 pF / 0.180 μF	1000 pF / 0.082 μF	1000 pF / 0.018 μF	1000 pF / 0.01 μF	100 pF / 6800 pF	100 pF / 4700 pF	100 pF / 1800 pF	—
SV04/SV54	1000 pF / 0.056 μF	1000 pF / 0.033 μF	100 pF / 6800 pF	100 pF / 3900 pF	100 pF / 2200 pF	100 pF / 1800 pF	100 pF / 820 pF	—
SV05/SV55	0.01 μF / 0.470 μF	0.01 μF / 0.22 μF	1000 pF / 0.056 μF	1000 pF / 0.027 μF	1000 pF / 0.018 μF	1000 pF / 0.012 μF	100 pF / 4700 pF	—
SV06/SV56	0.01 μF / 0.180 μF	0.01 μF / 0.10 μF	1000 pF / 0.033 μF	1000 pF / 0.012 μF	100 pF / 8200 pF	100 pF / 6800 pF	100 pF / 2700 pF	100 pF / 1200 pF
SV07/SV57	0.01 μF / 0.820 μF	0.01 μF / 0.39 μF	0.01 μF / 0.10 μF	1000 pF / 0.047 μF	1000 pF / 0.033 μF	1000 pF / 0.027 μF	1000 pF / 0.01 μF	100 pF / 6800 pF
SV08/SV58	0.01 μF / 1.20 μF	0.01 μF / 0.68 μF	0.01 μF / 0.18 μF	1000 pF / 0.082 μF	1000 pF / 0.068 μF	1000 pF / 0.047 μF	1000 pF / 0.018 μF	1000 pF / 0.012 μF
SV09/SV59	0.10 μF / 1.80 μF	0.10 μF / 1.00 μF	0.01 μF / 0.27 μF	0.01 μF / 0.12 μF	0.01 μF / 0.10 μF	1000 pF / 0.068 μF	1000 pF / 0.027 μF	1000 pF / 0.018 μF
SV10	0.01 μF / 1.50 μF	0.01 μF / 0.82 μF	0.01 μF / 0.22 μF	0.01 μF / 0.10 μF	1000 pF / 0.082 μF	1000 pF / 0.056 μF	1000 pF / 0.022 μF	1000 pF / 0.022 μF
SV11	0.10 μF / 2.20 μF	0.10 μF / 1.2 μF	0.01 μF / 0.39 μF	0.01 μF / 0.18 μF	0.01 μF / 0.15 μF	0.01 μF / 0.10 μF	1000 pF / 0.039 μF	1000 pF / 0.027 μF
SV12	0.10 μF / 3.90 μF	0.10 μF / 2.20 μF	0.01 μF / 0.56 μF	0.01 μF / 0.27 μF	0.01 μF / 0.22 μF	0.01 μF / 0.15 μF	1000 pF / 0.056 μF	1000 pF / 0.033 μF
SV13/SV63	0.01 μF / 0.270 μF	0.01 μF / 0.10 μF	1000 pF / 0.033 μF	1000 pF / 0.012 μF	1000 pF / 0.01 μF	100 pF / 6800 pF	100 pF / 2700 pF	—
SV14/SV64	0.01 μF / 0.470 μF	0.01 μF / 0.18 μF	1000 pF / 0.068 μF	1000 pF / 0.022 μF	1000 pF / 0.018 μF	1000 pF / 0.015 μF	100 pF / 5600 pF	—
SV15/SV65	0.01 μF / 0.680 μF	0.01 μF / 0.33 μF	0.01 μF / 0.10 μF	1000 pF / 0.033 μF	1000 pF / 0.027 μF	1000 pF / 0.022 μF	1000 pF / 8200 pF	100 pF / 4700 pF
SV16/SV66	0.01 μF / 1.80 μF	0.01 μF / 1.0 μF	0.01 μF / 0.27 μF	0.01 μF / 0.12 μF	0.01 μF / 0.10 μF	1000 pF / 0.068 μF	1000 pF / 0.027 μF	1000 pF / 0.018 μF
SV17/SV67	0.01 μF / 2.20 μF	0.01 μF / 1.2 μF	0.01 μF / 0.39 μF	0.01 μF / 0.15 μF	0.01 μF / 0.12 μF	1000 pF / 0.082 μF	1000 pF / 0.039 μF	1000 pF / 0.027 μF

Note: Contact factory for other voltage ratings or values.

AVX IS QUALIFIED TO THE FOLLOWING DSCC DRAWINGS

Specification #	Description	Capacitance Range
87046	C0G-1000 VDC	10 pF - 0.025 μF
87043	X7R-1000 VDC	100 pF - 0.47 μF
87040	X7R-2000 VDC	100 pF - 0.22 μF
87114	C0G-3000 VDC	10 pF - 8200 pF
87047	X7R-3000 VDC	100 pF - 0.1 μF
87076	C0G-4000 VDC	10 pF - 6800 pF
89044	X7R-4000 VDC	100 pF - 0.056 μF
87077	C0G-5000 VDC	10 pF - 5600 pF
87070	X7R-5000 VDC	100 pF - 0.033 μF

These specifications require group A and B testing per MIL-PRF-49467

Note: Customers may accept, at their discretion, a certificate of compliance with group B requirements in lieu of performing group B tests.

MLC Chip Capacitors

Basic Construction

A multilayer ceramic (MLC) capacitor is a monolithic block of ceramic containing two sets of offset, interleaved planar electrodes that extend to two opposite surfaces of the ceramic dielectric. This simple structure requires a

considerable amount of sophistication, both in material and in manufacture, to produce it in the quality and quantities needed in today's electronic equipment.

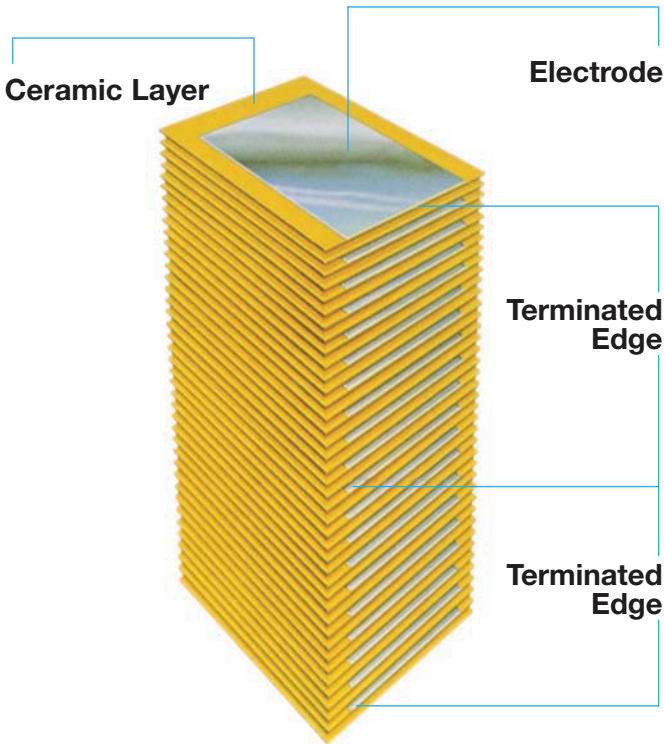

Terminations

- Standard Nickel Barrier
Lead Free Tin Plate (RoHS Compliant)
5% minimum Lead Plated
- Leach resistance to 90 seconds at 260°C
- Solderable plated for dimensional control
- Special materials as required

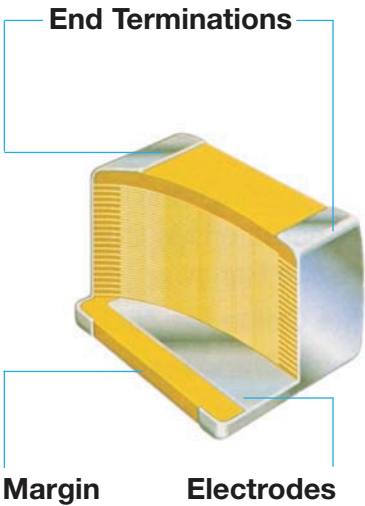

QUALITY STATEMENT

AVX focus is customer satisfaction – Customer satisfaction in the broadest sense: Products, service, price, delivery, technical support, and all the aspects of a business that impact you, the customer.

Our long term strategy is for continuous improvement which is defined by our Quality Vision 2000. This is a total quality management system developed by and supported by AVX corporate management. The foundation of QV2000 is built

upon military and commercial standards and systems including ISO9001. QV2000 is a natural extension of past quality efforts with world class techniques for ensuring a total quality environment to satisfy our customers during this decade and into the 21st century.

As your components supplier, we invite you to experience the quality, service, and commitment of AVX.

Table 1: EIA and MIL Temperature Stable and General Application Codes

EIA CODE	
Percent Capacity Change Over Temperature Range	
RS198	Temperature Range
X7	-55°C to +125°C
X5	-55°C to +85°C
Y5	-30°C to +85°C
Z5	+10°C to +85°C
Code	Percent Capacity Change
D	±3.3%
E	±4.7%
F	±7.5%
P	±10%
R	±15%
S	±22%
T	+22%, -33%
U	+22%, -56%
V	+22%, -82%

EXAMPLE – A capacitor is desired with the capacitance value at 25°C to increase no more than 7.5% or decrease no more than 7.5% from -30°C to +85°C. EIA Code will be Y5F.

MIL CODE		
Symbol	Temperature Range	
A	-55°C to +85°C	
B	-55°C to +125°C	
C	-55°C to +150°C	
Symbol	Cap. Change Zero Volts	Cap. Change Rated Volts
Q	+15%, -15%	+15%, -50%
R	+15%, -15%	+15%, -40%
W	+22%, -56%	+22%, -66%
X	+15%, -15%	+15%, -25%
Y	+30%, -70%	+30%, -80%
Z	+20%, -20%	+20%, -30%

Temperature characteristic is specified by combining range and change symbols, for example BR or AW. Specification slash sheets indicate the characteristic applicable to a given style of capacitor.

In specifying capacitance change with temperature for Class 2 materials, EIA expresses the capacitance change over an operating temperature range by a 3 symbol code. The first symbol represents the cold temperature end of the temperature range, the second represents the upper limit of the operating temperature range and the third symbol represents the capacitance change allowed over the operating temperature range. Table 1 provides a detailed explanation of the EIA system.

Effects of Voltage – Variations in voltage have little effect on Class 1 dielectric but does affect the capacitance and dissipation factor of Class 2 dielectrics. The application of DC voltage reduces both the capacitance and dissipation factor while the application of an AC voltage within a reasonable range tends to increase both capacitance and dissipation factor readings. If a high enough AC voltage is applied, eventually it will reduce capacitance just as a DC voltage will. Figure 2 shows the effects of AC voltage.

Cap. Change vs. A.C. Volts
X7R

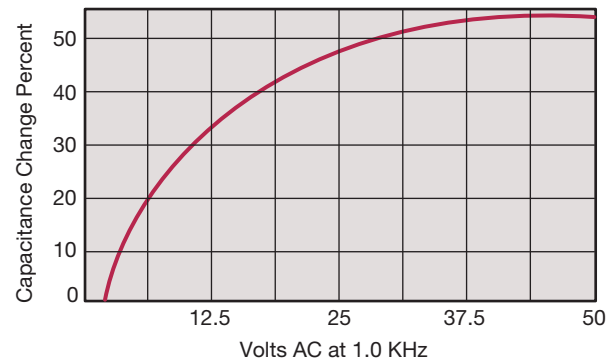

Figure 2

Capacitor specifications specify the AC voltage at which to measure (normally 0.5 or 1 VAC) and application of the wrong voltage can cause spurious readings.

Typical Cap. Change vs. Temperature
X7R

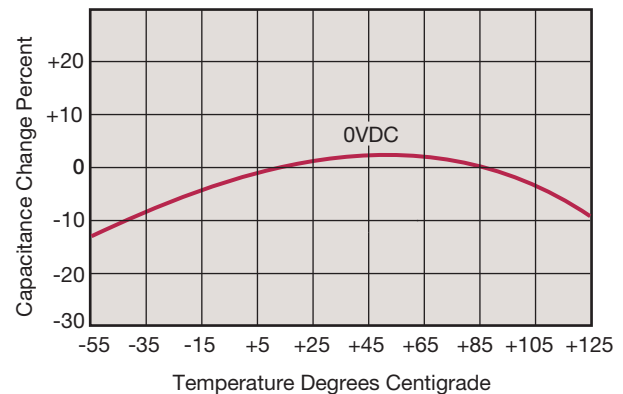

Figure 3

Effects of Time – Class 2 ceramic capacitors change capacitance and dissipation factor with time as well as temperature, voltage and frequency. This change with time is known as aging. Aging is caused by a gradual re-alignment of the crystalline structure of the ceramic and produces an exponential loss in capacitance and decrease in dissipation factor versus time. A typical curve of aging rate for semi-stable ceramics is shown in Figure 4.

If a Class 2 ceramic capacitor that has been sitting on the shelf for a period of time, is heated above its curie point, (125°C for 4 hours or 150°C for ½ hour will suffice) the part will de-age and return to its initial capacitance and dissipation factor readings. Because the capacitance changes rapidly, immediately after de-aging, the basic capacitance measurements are normally referred to a time period some-time after the de-aging process. Various manufacturers use different time bases but the most popular one is one day or twenty-four hours after “last heat.” Change in the aging curve can be caused by the application of voltage and other stresses. The possible changes in capacitance due to de-aging by heating the unit explain why capacitance changes are allowed after test, such as temperature cycling, moisture resistance, etc., in MIL specs. The application of high voltages such as dielectric withstanding voltages also tends to de-age capacitors and is why re-reading of capacitance after 12 or 24 hours is allowed in military specifications after dielectric strength tests have been performed.

Effects of Frequency – Frequency affects capacitance and impedance characteristics of capacitors. This effect is much more pronounced in high dielectric constant ceramic formulation than in low K formulations. AVX’s SpiCalci software generates impedance, ESR, series inductance, series resonant frequency and capacitance all as functions of frequency, temperature and DC bias for standard chip sizes and styles. It is available free from AVX and can be downloaded for free from AVX website: www.avx.com.



**Typical Curve of Aging Rate
X7R**

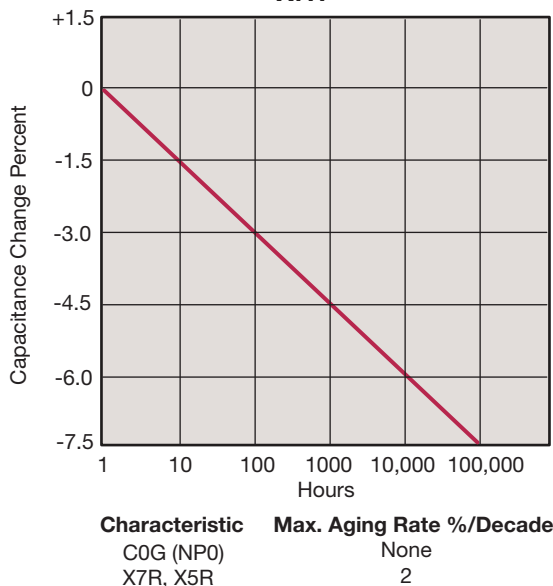

Figure 4

Effects of Mechanical Stress – High “K” dielectric ceramic capacitors exhibit some low level piezoelectric reactions under mechanical stress. As a general statement, the piezo-electric output is higher, the higher the dielectric constant of the ceramic. It is desirable to investigate this effect before using high “K” dielectrics as coupling capacitors in extremely low level applications.

Reliability – Historically ceramic capacitors have been one of the most reliable types of capacitors in use today. The approximate formula for the reliability of a ceramic capacitor is:

$$\frac{L_o}{L_t} = \left(\frac{V_t}{V_o}\right)^X \left(\frac{T_t}{T_o}\right)^Y$$

where

- L_o = operating life
- L_t = test life
- V_t = test voltage
- V_o = operating voltage
- T_t = test temperature and
- T_o = operating temperature in °C
- X, Y = see text

Historically for ceramic capacitors exponent X has been considered as 3. The exponent Y for temperature effects typically tends to run about 8.

A capacitor is a component which is capable of storing electrical energy. It consists of two conductive plates (electrodes) separated by insulating material which is called the dielectric. A typical formula for determining capacitance is:

$$C = \frac{.224 KA}{t}$$

- C** = capacitance (picofarads)
- K** = dielectric constant (Vacuum = 1)
- A** = area in square inches
- t** = separation between the plates in inches (thickness of dielectric)
- .224** = conversion constant (.0884 for metric system in cm)

Capacitance – The standard unit of capacitance is the farad. A capacitor has a capacitance of 1 farad when 1 coulomb charges it to 1 volt. One farad is a very large unit and most capacitors have values in the micro (10^{-6}), nano (10^{-9}) or pico (10^{-12}) farad level.

Dielectric Constant – In the formula for capacitance given above the dielectric constant of a vacuum is arbitrarily chosen as the number 1. Dielectric constants of other materials are then compared to the dielectric constant of a vacuum.

Dielectric Thickness – Capacitance is indirectly proportional to the separation between electrodes. Lower voltage requirements mean thinner dielectrics and greater capacitance per volume.

Area – Capacitance is directly proportional to the area of the electrodes. Since the other variables in the equation are usually set by the performance desired, area is the easiest parameter to modify to obtain a specific capacitance within a material group.

Energy Stored – The energy which can be stored in a capacitor is given by the formula:

$$E = \frac{1}{2}CV^2$$

- E** = energy in joules (watts-sec)
- V** = applied voltage
- C** = capacitance in farads

Potential Change – A capacitor is a reactive component which reacts against a change in potential across it. This is shown by the equation for the linear charge of a capacitor:

$$I_{ideal} = C \frac{dV}{dt}$$

where

- I** = Current
- C** = Capacitance
- dV/dt** = Slope of voltage transition across capacitor

Thus an infinite current would be required to instantly change the potential across a capacitor. The amount of current a capacitor can “sink” is determined by the above equation.

Equivalent Circuit – A capacitor, as a practical device, exhibits not only capacitance but also resistance and inductance. A simplified schematic for the equivalent circuit is:

- C** = Capacitance
- L** = Inductance
- R_s** = Series Resistance
- R_p** = Parallel Resistance

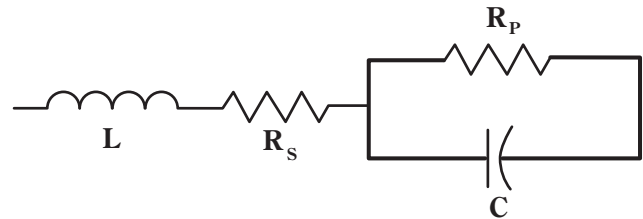

Reactance – Since the insulation resistance (R_p) is normally very high, the total impedance of a capacitor is:

$$Z = \sqrt{R_s^2 + (X_c - X_L)^2}$$

where

- Z** = Total Impedance
- R_s** = Series Resistance
- X_c** = Capacitive Reactance = $\frac{1}{2 \pi fC}$
- X_L** = Inductive Reactance = $2 \pi fL$

The variation of a capacitor's impedance with frequency determines its effectiveness in many applications.

Phase Angle – Power Factor and Dissipation Factor are often confused since they are both measures of the loss in a capacitor under AC application and are often almost identical in value. In a “perfect” capacitor the current in the capacitor will lead the voltage by 90° .

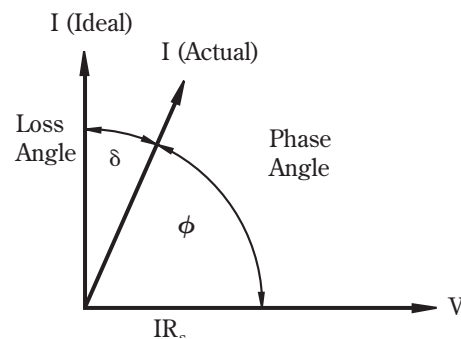

In practice the current leads the voltage by some other phase angle due to the series resistance R_s . The complement of this angle is called the loss angle and:

- Power Factor (P.F.) = $\cos \phi$ or $\sin \delta$
- Dissipation Factor (D.F.) = $\tan \delta$

for small values of δ the \tan and \sin are essentially equal which has led to the common interchangeability of the two terms in the industry.

Equivalent Series Resistance – The term E.S.R. or Equivalent Series Resistance combines all losses both series and parallel in a capacitor at a given frequency so that the equivalent circuit is reduced to a simple R-C series connection.

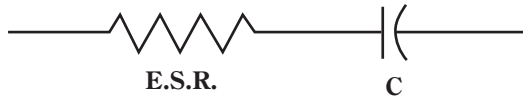

Dissipation Factor – The DF/PF of a capacitor tells what percent of the apparent power input will turn to heat in the capacitor.

$$\text{Dissipation Factor} = \frac{\text{E.S.R.}}{X_c} = (2 \pi fC) (\text{E.S.R.})$$

The watts loss are:

$$\text{Watts loss} = (2 \pi fCV^2) (\text{D.F.})$$

Very low values of dissipation factor are expressed as their reciprocal for convenience. These are called the “Q” or Quality factor of capacitors.

Parasitic Inductance – The parasitic inductance of capacitors is becoming more and more important in the decoupling of today’s high speed digital systems. The relationship between the inductance and the ripple voltage induced on the DC voltage line can be seen from the simple inductance equation:

$$V = L \frac{di}{dt}$$

The $\frac{di}{dt}$ seen in current microprocessors can be as high as 0.3 A/ns, and up to 10A/ns. At 0.3 A/ns, 100pH of parasitic inductance can cause a voltage spike of 30mV. While this does not sound very drastic, with the Vcc for microprocessors decreasing at the current rate, this can be a fairly large percentage.

Another important, often overlooked, reason for knowing the parasitic inductance is the calculation of the resonant frequency. This can be important for high frequency, by-pass capacitors, as the resonant point will give the most signal attenuation. The resonant frequency is calculated from the simple equation:

$$f_{res} = \frac{1}{2\pi\sqrt{LC}}$$

Insulation Resistance – Insulation Resistance is the resistance measured across the terminals of a capacitor and consists principally of the parallel resistance R_P shown in the equivalent circuit. As capacitance values and hence the area of dielectric increases, the I.R. decreases and hence the product ($C \times IR$ or RC) is often specified in ohm farads or more commonly megohm-microfarads. Leakage current is determined by dividing the rated voltage by IR (Ohm’s Law).

Dielectric Strength – Dielectric Strength is an expression of the ability of a material to withstand an electrical stress. Although dielectric strength is ordinarily expressed in volts, it is actually dependent on the thickness of the dielectric and thus is also more generically a function of volts/mil.

Dielectric Absorption – A capacitor does not discharge instantaneously upon application of a short circuit, but drains gradually after the capacitance proper has been discharged. It is common practice to measure the dielectric absorption by determining the “reappearing voltage” which appears across a capacitor at some point in time after it has been fully discharged under short circuit conditions.

Corona – Corona is the ionization of air or other vapors which causes them to conduct current. It is especially prevalent in high voltage units but can occur with low voltages as well where high voltage gradients occur. The energy discharged degrades the performance of the capacitor and can in time cause catastrophic failures.

REFLOW SOLDERING

Case Size	millimeters (inches)				
	D1	D2	D3	D4	D5
0805 (LD05)	3.00 (0.120)	1.00 (0.040)	1.00 (0.040)	1.00 (0.040)	1.25 (0.050)
1206 (LD06)	4.00 (0.160)	1.00 (0.040)	2.00 (0.090)	1.00 (0.040)	1.60 (0.060)
*1210 (LD10)	4.00 (0.160)	1.00 (0.040)	2.00 (0.090)	1.00 (0.040)	2.50 (0.100)
*1808 (LD08)	5.60 (0.220)	1.00 (0.040)	3.60 (0.140)	1.00 (0.040)	2.00 (0.080)
*1812 (LD12)	5.60 (0.220)	1.00 (0.040)	3.60 (0.140)	1.00 (0.040)	3.00 (0.120)
*1825 (LD13)	5.60 (0.220)	1.00 (0.040)	3.60 (0.140)	1.00 (0.040)	6.35 (0.250)
*2220 (LD20)	6.60 (0.260)	1.00 (0.040)	4.60 (0.180)	1.00 (0.040)	5.00 (0.200)
*2225 (LD14)	6.60 (0.260)	1.00 (0.040)	4.60 (0.180)	1.00 (0.040)	6.35 (0.250)
*HQCC	6.60 (0.260)	1.00 (0.040)	4.60 (0.180)	1.00 (0.040)	6.35 (0.250)
*3640 (LD40)	10.67 (0.427)	1.52 (0.060)	7.62 (0.300)	1.52 (0.060)	10.16 (0.400)
*HQCE	10.67 (0.427)	1.52 (0.060)	7.62 (0.300)	1.52 (0.060)	10.16 (0.400)

Dimensions in millimeters (inches)

*AVX recommends reflow soldering only.

Component Pad Design

Component pads should be designed to achieve good solder filets and minimize component movement during reflow soldering. Pad designs are given below for the most common sizes of multilayer ceramic capacitors for both wave and reflow soldering. The basis of these designs is:

- Pad width equal to component width. It is permissible to decrease this to as low as 85% of component width but it is not advisable to go below this.
- Pad overlap 0.5mm beneath component.
- Pad extension 0.5mm beyond components for reflow and 1.0mm for wave soldering.

WAVE SOLDERING

Case Size	D1	D2	D3	D4	D5
0805	4.00 (0.15)	1.50 (0.06)	1.00 (0.04)	1.50 (0.06)	1.25 (0.05)
1206	5.00 (0.19)	1.50 (0.06)	2.00 (0.09)	1.50 (0.06)	1.60 (0.06)

Dimensions in millimeters (inches)

Component Spacing

For wave soldering components, must be spaced sufficiently far apart to avoid bridging or shadowing (inability of solder to penetrate properly into small spaces). This is less important for reflow soldering but sufficient space must be allowed to enable rework should it be required.

Preheat & Soldering

The rate of preheat should not exceed 4°C/second to prevent thermal shock. A better maximum figure is about 2°C/second.

For capacitors size 1206 and below, with a maximum thickness of 1.25mm, it is generally permissible to allow a temperature differential from preheat to soldering of 150°C. In all other cases this differential should not exceed 100°C.

For further specific application or process advice, please consult AVX.

Cleaning

Care should be taken to ensure that the capacitors are thoroughly cleaned of flux residues especially the space beneath the capacitor. Such residues may otherwise become conductive and effectively offer a low resistance bypass to the capacitor.

Ultrasonic cleaning is permissible, the recommended conditions being 8 Watts/litre at 20-45 kHz, with a process cycle of 2 minutes vapor rinse, 2 minutes immersion in the ultrasonic solvent bath and finally 2 minutes vapor rinse.

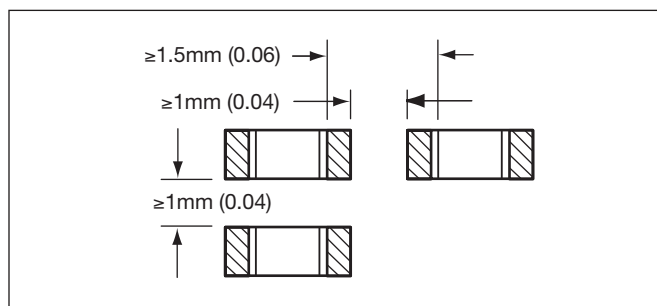

Recommended Soldering Profiles

REFLOW SOLDER PROFILES

AVX RoHS compliant products utilize termination finishes (e.g. Sn or SnAg) that are compatible with all Pb-Free soldering systems and are fully reverse compatible with SnPb soldering systems. A recommended SnPb profile is shown for comparison; for Pb-Free soldering, IPC/JEDECJ-STD-020C may be referenced. The upper line in the chart shows the maximum envelope to which products are qualified (typically 3x reflow cycles at 260°C max). The center line gives the recommended profile for optimum wettability and soldering in Pb-Free Systems.

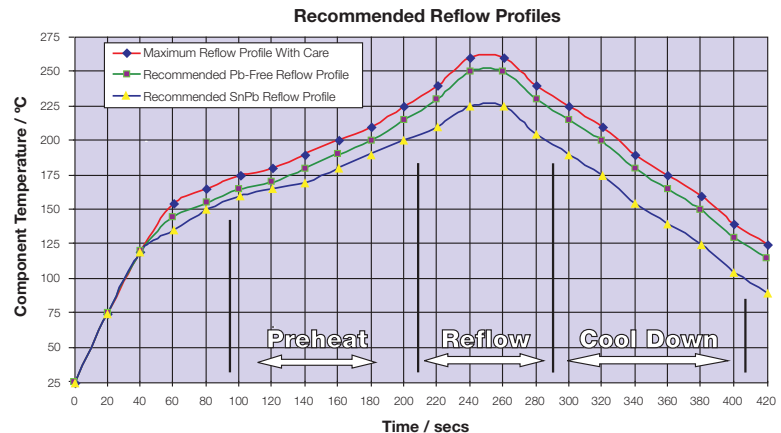

Preheat:

The pre-heat stabilizes the part and reduces the temperature differential prior to reflow. The initial ramp to 125°C may be rapid, but from that point (2-3)°C/sec is recommended to allow ceramic parts to heat uniformly and plastic encapsulated parts to stabilize through the glass transition temperature of the body (~ 180°C).

Reflow:

In the reflow phase, the maximum recommended time > 230°C is 40secs. Time at peak reflow is 10secs max.; optimum reflow is achieved at 250°C, (see wetting balance chart opposite) but products are qualified to 260°C max. Please reference individual product datasheets for maximum limits

Cool Down:

Cool down should not be forced and 6°C/sec is recommended. A slow cool down will result in a finer grain structure of the reflow solder in the solder fillet.

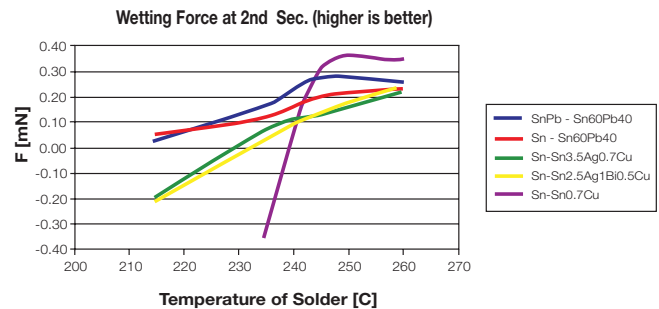

IMPORTANT NOTE: Typical Pb-Free reflow solders have a more dull and grainy appearance compared to traditional SnPb. Elevating the reflow temperature will not change this, but extending the cool down can help improve the visual appearance of the joint.

WAVE SOLDER PROFILES

For wave solder, there is no change in the recommended wave profile; all standard Pb-Free (SnCu/SnCuAg) systems operate at the same 260°C max recommended for SnPb systems.

Preheat:

This is more important for wave solder; a higher temperature preheat will reduce the thermal shock to SMD parts that are immersed (please consult individual product data sheets for SMD parts that are suited to wave solder). SMD parts should ideally be heated from the bottom-Side prior to wave. PTH (Pin through hole) parts on the topside should not be separately heated.

Wave:

250°C – 260°C recommended for optimum solderability.

Cool Down:

As with reflow solder, cool down should not be forced and 6°C/sec is recommended. Any air knives at the end of the 2nd wave should be heated.

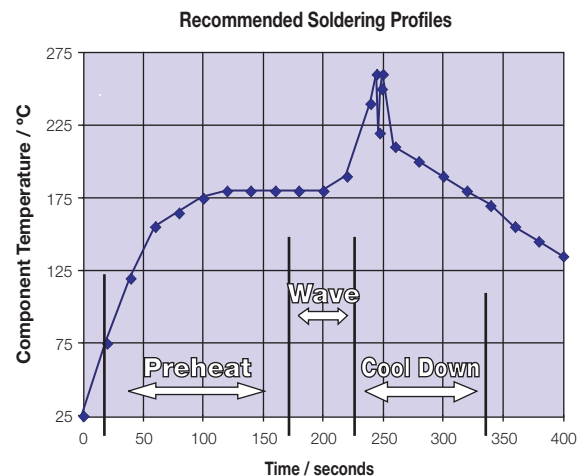

Surface Mounting Guide



MLC Chip Capacitors

APPLICATION NOTES

Storage

Good solderability is maintained for at least twelve months, provided the components are stored in their "as received" packaging at less than 40°C and 70% RH.

Solderability

Terminations to be well soldered after immersion in a 60/40 tin/lead solder bath at $235 \pm 5^\circ\text{C}$ for 2 ± 1 seconds.

Leaching

Terminations will resist leaching for at least the immersion times and conditions shown below.

Termination Type	Solder Tin/Lead/Silver	Solder Temp. °C	Immersion Time Seconds
Nickel Barrier	60/40/0	260 ± 5	30 ± 1

Recommended Soldering Profiles

Reflow

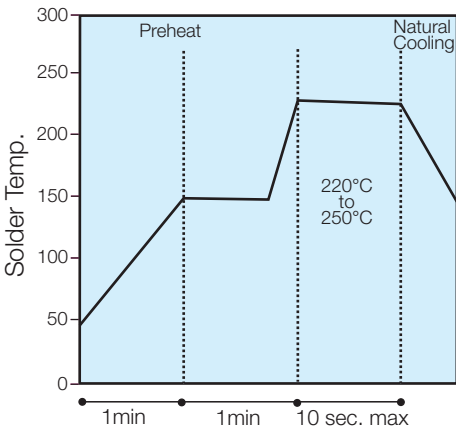

(Minimize soldering time)

Lead-Free Reflow Profile

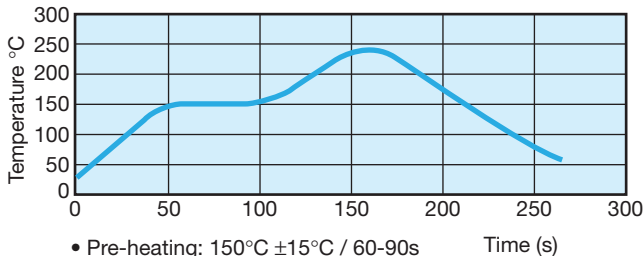

- Pre-heating: $150^\circ\text{C} \pm 15^\circ\text{C}$ / 60-90s
- Max. Peak Gradient 2.5°C/s
- Peak Temperature: $245^\circ\text{C} \pm 5^\circ\text{C}$
- Time at $>230^\circ\text{C}$: 40s Max.

Wave

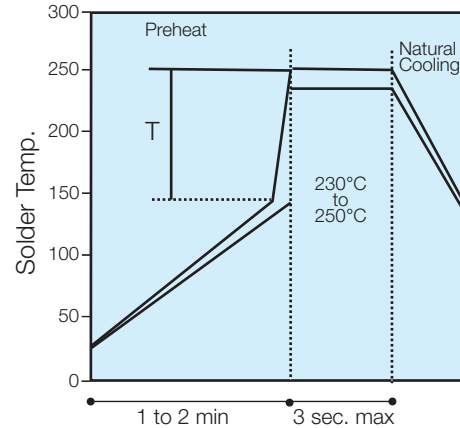

(Preheat chips before soldering)
T/maximum 150°C

Lead-Free Wave Soldering

The recommended peak temperature for lead-free wave soldering is 250°C - 260°C for 3-5 seconds. The other parameters of the profile remains the same as above.

The following should be noted by customers changing from lead based systems to the new lead free pastes.

- The visual standards used for evaluation of solder joints will need to be modified as lead free joints are not as bright as with tin-lead pastes and the fillet may not be as large.
- Resin color may darken slightly due to the increase in temperature required for the new pastes.
- Lead-free solder pastes do not allow the same self alignment as lead containing systems. Standard mounting pads are acceptable, but machine set up may need to be modified.

General

Surface mounting chip multilayer ceramic capacitors are designed for soldering to printed circuit boards or other substrates. The construction of the components is such that they will withstand the time/temperature profiles used in both wave and reflow soldering methods.

Handling

Chip multilayer ceramic capacitors should be handled with care to avoid damage or contamination from perspiration and skin oils. The use of tweezers or vacuum pick ups is strongly recommended for individual components. Bulk handling should ensure that abrasion and mechanical shock are minimized. Taped and reeled components provides the ideal medium for direct presentation to the placement machine. Any mechanical shock should be minimized during handling chip multilayer ceramic capacitors.

Preheat

It is important to avoid the possibility of thermal shock during soldering and carefully controlled preheat is therefore required. The rate of preheat should not exceed 4°C/second

MLC Chip Capacitors

and a target figure 2°C/second is recommended. Although an 80°C to 120°C temperature differential is preferred, recent developments allow a temperature differential between the component surface and the soldering temperature of 150°C (Maximum) for capacitors of 1210 size and below with a maximum thickness of 1.25mm. The user is cautioned that the risk of thermal shock increases as chip size or temperature differential increases.

Soldering

Mildly activated rosin fluxes are preferred. The minimum amount of solder to give a good joint should be used. Excessive solder can lead to damage from the stresses caused by the difference in coefficients of expansion between solder, chip and substrate. AVX terminations are suitable for all wave and reflow soldering systems. If hand soldering cannot be avoided, the preferred technique is the utilization of hot air soldering tools.

Cooling

Natural cooling in air is preferred, as this minimizes stresses within the soldered joint. When forced air cooling is used, cooling rate should not exceed 4°C/second. Quenching is not recommended but if used, maximum temperature differentials should be observed according to the preheat conditions above.

Cleaning

Flux residues may be hygroscopic or acidic and must be removed. AVX MLC capacitors are acceptable for use with all of the solvents described in the specifications MIL-STD-202 and EIA-RS-198. Alcohol based solvents are acceptable and properly controlled water cleaning systems are also acceptable. Many other solvents have been proven successful, and most solvents that are acceptable to other components on circuit assemblies are equally acceptable for use with ceramic capacitors.

POST SOLDER HANDLING

Once SMP components are soldered to the board, any bending or flexure of the PCB applies stresses to the soldered joints of the components. For leaded devices, the stresses are absorbed by the compliancy of the metal leads and generally don't result in problems unless the stress is large enough to fracture the soldered connection.

Ceramic capacitors are more susceptible to such stress because they don't have compliant leads and are brittle in nature. The most frequent failure mode is low DC resistance or short circuit. The second failure mode is significant loss of capacitance due to severing of contact between sets of the internal electrodes.

Cracks caused by mechanical flexure are very easily identified and generally take one of the following two general forms:



Type A:
Angled crack between bottom of device to top of solder joint.

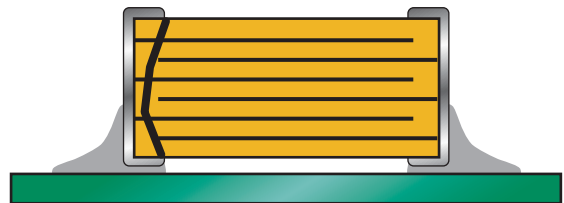

Type B:
Fracture from top of device to bottom of device.

Mechanical cracks are often hidden underneath the termination and are difficult to see externally. However, if one end termination falls off during the removal process from PCB, this is one indication that the cause of failure was excessive mechanical stress due to board warping.

MLC Chip Capacitors

COMMON CAUSES OF MECHANICAL CRACKING

The most common source for mechanical stress is board depanelization equipment, such as manual breakapart, v-cutters and shear presses. Improperly aligned or dull cutters may cause torqueing of the PCB resulting in flex stresses being transmitted to components near the board edge. Another common source of flexural stress is contact during parametric testing when test points are probed. If the PCB is allowed to flex during the test cycle, nearby ceramic capacitors may be broken.

A third common source is board to board connections at vertical connectors where cables or other PCBs are connected to the PCB. If the board is not supported during the plug/unplug cycle, it may flex and cause damage to nearby components.

Special care should also be taken when handling large (>6" on a side) PCBs since they more easily flex or warp than smaller boards.

REWORKING OF MLCs

Thermal shock is common in MLCs that are manually attached or reworked with a soldering iron. *AVX strongly recommends that any reworking of MLCs be done with hot air reflow rather than soldering irons.* It is practically impossible to cause any thermal shock in ceramic capacitors when using hot air reflow.

However direct contact by the soldering iron tip often causes thermal cracks that may fail at a later date. If rework by soldering iron is absolutely necessary, it is recommended that the wattage of the iron be less than 30 watts and the tip temperature be <math><300^{\circ}\text{C}</math>. *Rework should be performed by applying the solder iron tip to the pad and not directly contacting any part of the ceramic capacitor.*

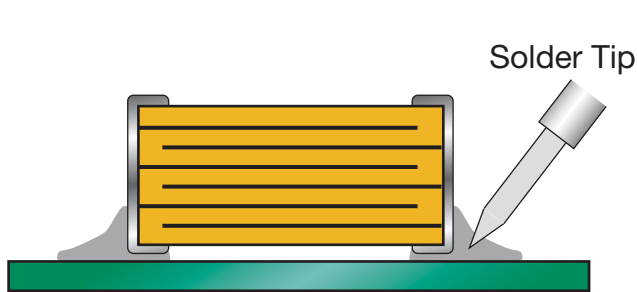

Preferred Method - No Direct Part Contact

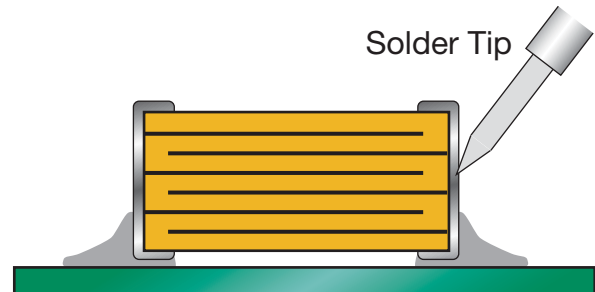

Poor Method - Direct Contact with Part

PCB BOARD DESIGN

To avoid many of the handling problems, AVX recommends that MLCs be located at least .2" away from nearest edge of board. However when this is not possible, AVX recommends that the panel be routed along the cut line, adjacent to where the MLC is located.

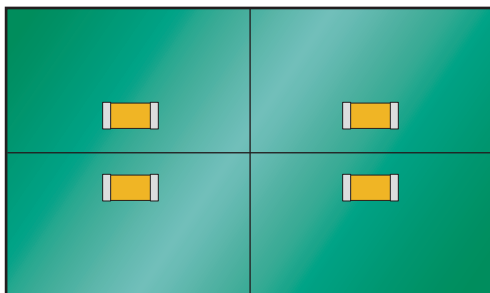

No Stress Relief for MLCs

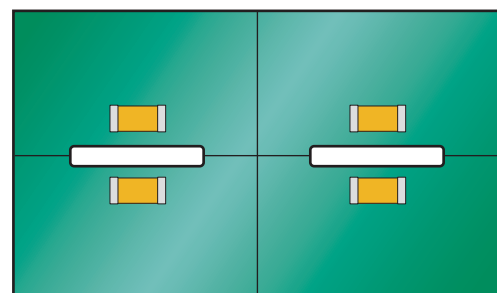

Routed Cut Line Relieves Stress on MLC

MIL-PRF-123/Chips

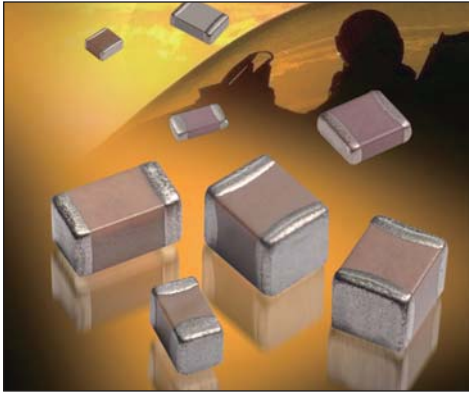

AVX Corp.'s M123 Series MIL-qualified ceramic capacitors are designed for high performance applications in BX and BR voltage levels, and for temperature stable applications in BP and BG voltage levels. The M123A10-M123A23 have been tested in accordance with MIL-PRF-123 specifications and are available in a wide range of values and tolerances.

M123 Series capacitors offer design and component engineers a proven technology for SMD processing and applications requiring space-level reliability. They are designed for use in critical frequency applications, timing circuits, and applications where absolute stability is required (BP and BG), as well as in applications where a wider capacitance variation in temperature, voltage, frequency, and life span can be tolerated (BX and BR).

HOW TO ORDER

Military Type Designation: Capacitors, Fixed, Ceramic Dielectric, (Temperature Stable and General Purpose), High Reliability

M123	A	10	BX	B	103	K	S
Mil-Spec Number	Modification Spec.	Slash Sheet Number	Temperature Characteristic	Voltage B = 50 C = 100	Capacitance Code	Capacitance Tolerance C = ±0.25pF D = ±0.5pF F = ±1% J = ±5% K = ±10%	Termination G = Silver - Nickel - Gold M = Palladium/Silver S = Silver - Nickel - Solder Coated Z = Silver - Nickel - Solder Plated (tin/lead alloy with a minimum of 4 percent lead)
			Capacitance change with reference to 25°C over temperature range -55°C to +125°C				
			Symbol	Without Voltage	With Rated DC Voltage		
			BP	0 ± 30 ppm/°C	0 ± 30 ppm/°C		
			BX	+15, -15%	+15, -25%		

DIMENSIONS

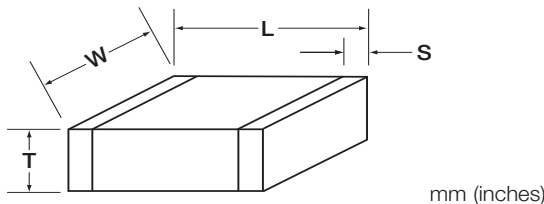

mm (inches)

(L) Length	(W) Width	(T) Thickness	(S) Termination Band
CKS51, /10, 0805 Size Chip			
2.03 (0.080) ± 0.381 (0.015)	1.27 (0.050) ± 0.381 (0.015)	0.508 (0.020) Min. 1.40 (0.055) Max.	0.508 (0.020) ± 0.254 (0.010)
CKS52, /11, 1210 Size Chip			
3.05 (0.120) ± 0.381 (0.015)	2.54 (0.100) ± 0.381 (0.015)	0.508 (0.020) Min. 1.65 (0.065) Max.	0.508 (0.020) ± 0.254 (0.010)
CKS52, /12, 1808 Size Chip			
4.57 (0.180) ± 0.381 (0.015)	2.03 (0.080) ± 0.381 (0.015)	0.508 (0.020) Min. 1.65 (0.065) Max.	0.508 (0.020) ± 0.254 (0.010)
CKS54, /13, 2225 Size Chip			
5.59 (0.220) ± 0.381 (0.015)	6.35 (0.250) ± 0.381 (0.015)	0.508 (0.020) Min. 1.78 (0.070) Max.	0.508 (0.020) ± 0.254 (0.010)
CKS55, /21, 1206 Size Chip			
3.05 (0.120) ± 0.381 (0.015)	1.52 (0.060) ± 0.381 (0.015)	0.508 (0.020) Min. 1.65 (0.065) Max.	0.508 (0.020) ± 0.254 (0.010)
CKS56, /22, 1812 Size Chip			
4.57 (0.180) ± 0.381 (0.015)	3.18 (0.125) ± 0.381 (0.015)	0.508 (0.020) Min. 2.03 (0.080) Max.	0.508 (0.020) ± 0.254 (0.010)
CKS56, /23, 1825 Size Chip			
4.57 (0.180) ± 0.381 (0.015)	6.35 (0.250) ± 0.381 (0.015)	0.508 (0.020) Min. 2.03 (0.080) Max.	0.508 (0.020) ± 0.254 (0.010)

Slash Sheet	Case Size	Dielectric	Cap Range (pF)
10	0805	BP	1.0-680
		BX	330-470,000
11	1210	BP	300-3,300
		BX	5,600-100,000
12	1808	BP	300-1,000
		BX	5,600-100,000
13	2225	BP	1,100-10,000
		BX	120,000-1,000,000
21	1206	BP	1.0-2,200
		BX	4,700-39,000
22	1812	BP	1,200-10,000
		BX	27,000-180,000
23	1825	BP	3,900-20,000
		BX	56,000-470,000



MIL-PRF-123/STYLE CKS51, -/10

Part Number 1/ (0805 Size Chip)	Capacitance pF	Capacitance Tolerance	Voltage- Temperature Limits	Rated Voltage
M123A10BP_1R0_	1.0	C,D	BP	50,100
M123A10BP_1R1_	1.1	↓	↓	↓
M123A10BP_1R2_	1.2	↓	↓	↓
M123A10BP_1R3_	1.3	↓	↓	↓
M123A10BP_1R5_	1.5	↓	↓	↓
M123A10BP_1R6_	1.6	↓	↓	↓
M123A10BP_1R8_	1.8	↓	↓	↓
M123A10BP_2R0_	2.0	↓	↓	↓
M123A10BP_2R2_	2.2	↓	↓	↓
M123A10BP_2R4_	2.4	↓	↓	↓
M123A10BP_2R7_	2.7	↓	↓	↓
M123A10BP_3R0_	3.0	↓	↓	↓
M123A10BP_3R3_	3.3	↓	↓	↓
M123A10BP_3R6_	3.6	↓	↓	↓
M123A10BP_3R9_	3.9	↓	↓	↓
M123A10BP_4R3_	4.3	↓	↓	↓
M123A10BP_4R7_	4.7	↓	↓	↓
M123A10BP_5R1_	5.1	↓	↓	↓
M123A10BP_5R6_	5.6	↓	↓	↓
M123A10BP_6R2_	6.2	↓	↓	↓
M123A10BP_6R8_	6.8	↓	↓	↓
M123A10BP_7R5_	7.5	↓	↓	↓
M123A10BP_8R2_	8.2	↓	↓	↓
M123A10BP_9R1_	9.1	↓	↓	↓
M123A10BP_100_	10	C, J, K	↓	↓
M123A10BP_110_	11	↓	↓	↓
M123A10BP_120_	12	↓	↓	↓
M123A10BP_130_	13	↓	↓	↓
M123A10BP_150_	15	↓	↓	↓
M123A10BP_160_	16	↓	↓	↓
M123A10BP_180_	18	↓	↓	↓
M123A10BP_200_	20	↓	↓	↓
M123A10BP_220_	22	↓	↓	↓
M123A10BP_240_	24	↓	↓	↓
M123A10BP_270_	27	F, J, K	↓	↓
M123A10BP_300_	30	↓	↓	↓
M123A10BP_330_	33	↓	↓	↓
M123A10BP_360_	36	↓	↓	↓
M123A10BP_390_	39	↓	↓	↓
M123A10BP_430_	43	↓	↓	↓
M123A10BP_470_	47	↓	↓	↓
M123A10BP_510_	51	↓	↓	↓
M123A10BP_560_	56	↓	↓	↓
M123A10BP_620_	62	↓	↓	↓
M123A10BP_680_	68	↓	↓	↓
M123A10BP_750_	75	F, J, K	BP	50,100

Part Number 1/ (0805 Size Chip)	Capacitance pF	Capacitance Tolerance	Voltage- Temperature Limits	Rated Voltage
M123A10BP_820_	82	F, J, K	BP	50,100
M123A10BP_910_	91	↓	↓	↓
M123A10BP_101_	100	↓	↓	↓
M123A10BP_111_	110	↓	↓	↓
M123A10BP_121_	120	↓	↓	↓
M123A10BP_131_	130	↓	↓	↓
M123A10BP_151_	150	↓	↓	↓
M123A10BP_161_	160	↓	↓	↓
M123A10BP_181_	180	↓	↓	↓
M123A10BP_201_	200	↓	↓	↓
M123A10BP_221_	220	↓	↓	↓
M123A10BP_241_	240	↓	↓	↓
M123A10BP_271_	270	↓	↓	↓
M123A10BP_301_	300	↓	↓	↓
M123A10BP_331_	330	↓	↓	↓
M123A10BP_361_	360	↓	↓	↓
M123A10BP_391_	390	↓	↓	↓
M123A10BP_431_	430	↓	↓	↓
M123A10BP_471_	470	F,J,K	BP	50,100
M123A10BPB511_	510	F,J,K	BP	50
M123A10BPB561_	560	↓	↓	↓
M123A10BPB621_	620	↓	↓	↓
M123A10BPB681_	680	F,J,K	BP	50
M123A10BX_331K_	330	K	BX	50,100
M123A10BX_391K_	390	↓	↓	↓
M123A10BX_471K_	470	↓	↓	↓
M123A10BX_561K_	560	↓	↓	↓
M123A10BX_681K_	680	↓	↓	↓
M123A10BX_821K_	820	↓	↓	↓
M123A10BX_102K_	1,000	↓	↓	↓
M123A10BX_122K_	1,200	↓	↓	↓
M123A10BX_152K_	1,500	↓	↓	↓
M123A10BX_182K_	1,800	↓	↓	↓
M123A10BX_222K_	2,200	↓	↓	↓
M123A10BX_272K_	2,700	↓	↓	↓
M123A10BX_332K_	3,300	↓	↓	↓
M123A10BX_392K_	3,900	↓	↓	↓
M123A10BX_472K_	4,700	K	BX	50,100
M123A10BXB562K_	5,600	K	BX	50
M123A10BXB682K_	6,800	↓	↓	↓
M123A10BXB822K_	8,200	↓	↓	↓
M123A10BXB103K_	10,000	↓	↓	↓
M123A10BXB123K_	12,000	↓	↓	↓
M123A10BXB153K_	15,000	↓	↓	↓
M123A10BXB183K_	18,000	K	BX	50

MIL-PRF-123/STYLE CKS52, -/11

Part Number 1/ (1210 Size Chip)	Capacitance pF	Capacitance Tolerance	Voltage- Temperature Limits	Rated Voltage
M123A11BP_301_	300	F, J, K	BP	50,100
M123A11BP_331_	330	↓	↓	↓
M123A11BP_361_	360	↓	↓	↓
M123A11BP_391_	390	↓	↓	↓
M123A11BP_431_	430	↓	↓	↓
M123A11BP_471_	470	↓	↓	↓
M123A11BP_511_	510	↓	↓	↓
M123A11BP_561_	560	↓	↓	↓
M123A11BP_621_	620	↓	↓	↓
M123A11BP_681_	680	↓	↓	↓
M123A11BP_751_	750	↓	↓	↓
M123A11BP_821_	820	↓	↓	↓
M123A11BP_911_	910	↓	↓	↓
M123A11BP_102_	1,000	↓	↓	↓
M123A11BP_112_	1,100	↓	↓	↓
M123A11BP_122_	1,200	↓	↓	↓
M123A11BP_132_	1,300	↓	↓	↓
M123A11BP_152_	1,500	↓	↓	↓
M123A11BP_162_	1,600	↓	↓	↓
M123A11BP_182_	1,800	↓	↓	↓
M123A11BP_202_	2,000	↓	↓	↓
M123A11BP_222_	2,200	F, J, K	BP	50,100

Part Number 1/ (1210 Size Chip)	Capacitance pF	Capacitance Tolerance	Voltage- Temperature Limits	Rated Voltage
M123A11BPB242_	2,400	F, J, K	BP	50
M123A11BPB272_	2,700	↓	↓	↓
M123A11BPB302_	3,000	↓	↓	↓
M123A11BPB332_	3,300	F, J, K	BP	50
M123A11BX_562_	5,600	K, M	BX	50,100
M123A11BX_682_	6,800	↓	↓	↓
M123A11BX_822_	8,200	↓	↓	↓
M123A11BX_103_	10,000	↓	↓	↓
M123A11BX_123_	12,000	↓	↓	↓
M123A11BX_153_	15,000	↓	↓	↓
M123A11BX_183_	18,000	↓	↓	↓
M123A11BX_223_	22,000	↓	↓	↓
M123A11BX_273_	27,000	K, M	BX	50,100
M123A11BxB333_	33,000	K, M	BX	50
M123A11BxB393_	39,000	↓	↓	↓
M123A11BxB473_	47,000	↓	↓	↓
M123A11BxB563_	56,000	↓	↓	↓
M123A11BxB683_	68,000	↓	↓	↓
M123A11BxB823_	82,000	↓	↓	↓
M123A11BxB104_	100,000	K, M	BX	50

MIL-PRF-123/STYLE CKS53, -/12

Part Number 1/ (1808 Size Chip)	Capacitance pF	Capacitance Tolerance	Voltage- Temperature Limits	Rated Voltage
M123A12BP_301_	300	F, J, K	BP	50,100
M123A12BP_331_	330	↓	↓	↓
M123A12BP_361_	360	↓	↓	↓
M123A12BP_391_	390	↓	↓	↓
M123A12BP_431_	430	↓	↓	↓
M123A12BP_471_	470	↓	↓	↓
M123A12BP_511_	510	↓	↓	↓
M123A12BP_561_	560	↓	↓	↓
M123A12BP_621_	620	↓	↓	↓
M123A12BP_681_	680	↓	↓	↓
M123A12BP_751_	750	↓	↓	↓
M123A12BP_821_	820	↓	↓	↓
M123A12BP_911_	910	↓	↓	↓
M123A12BP_102_	1,000	F, J, K	BP	50,100

Part Number 1/ (1808 Size Chip)	Capacitance pF	Capacitance Tolerance	Voltage- Temperature Limits	Rated Voltage
M123A12BX_562K_	5,600	K	BX	50,100
M123A12BX_682K_	6,800	↓	↓	↓
M123A12BX_822K_	8,200	↓	↓	↓
M123A12BX_103K_	10,000	↓	↓	↓
M123A12BX_123K_	12,000	↓	↓	↓
M123A12BX_153K_	15,000	↓	↓	↓
M123A12BX_183K_	18,000	↓	↓	↓
M123A12BX_223K_	22,000	↓	↓	↓
M123A12BX_273K_	27,000	↓	↓	↓
M123A12BX_333K_	33,000	K	BX	50,100
M123A12BxB393K_	39,000	↓	↓	↓
M123A12BxB473K_	47,000	↓	↓	↓
M123A12BxB563K_	56,000	↓	↓	↓
M123A12BxB683K_	68,000	↓	↓	↓
M123A12BxB823K_	82,000	↓	↓	↓
M123A12BxB104K_	100,000	K	BX	50

MIL-PRF-123/STYLE CKS54, -/13

Part Number 1/ (2225 Size Chip)	Capacitance pF	Capacitance Tolerance	Voltage- Temperature Limits	Rated Voltage
M123A13BPB112_	1,100	F, J, K	BP	50
M123A13BPB122_	1,200	↓	↓	↓
M123A13BPB132_	1,300	↓	↓	↓
M123A13BPB152_	1,500	↓	↓	↓
M123A13BPB162_	1,600	↓	↓	↓
M123A13BPB182_	1,800	↓	↓	↓
M123A13BPB202_	2,000	↓	↓	↓
M123A13BPB222_	2,200	↓	↓	↓
M123A13BPB242_	2,400	↓	↓	↓
M123A13BPB272_	2,700	↓	↓	↓
M123A13BPB302_	3,000	↓	↓	↓
M123A13BPB332_	3,300	↓	↓	↓
M123A13BPB362_	3,600	↓	↓	↓
M123A13BPB392_	3,900	↓	↓	↓
M123A13BPB432_	4,300	↓	↓	↓
M123A13BPB472_	4,700	↓	↓	↓
M123A13BPB512_	5,100	F, J, K	BP	50

Part Number 1/ (2225 Size Chip)	Capacitance pF	Capacitance Tolerance	Voltage- Temperature Limits	Rated Voltage
M123A13BPB562_	5,600	F, J, K	BP	50
M123A13BPB622_	6,200	↓	↓	↓
M123A13BPB682_	6,800	↓	↓	↓
M123A13BPB752_	7,500	↓	↓	↓
M123A13BPB822_	8,200	↓	↓	↓
M123A13BPB912_	9,100	↓	↓	↓
M123A13BPB103_	10,000	F, J, K	BP	50
M123A13BxB124K_	120,000	K	BX	50
M123A13BxB154K_	150,000	↓	↓	↓
M123A13BxB184K_	180,000	↓	↓	↓
M123A13BxB224K_	220,000	↓	↓	↓
M123A13BxB274K_	270,000	↓	↓	↓
M123A13BxB334K_	330,000	↓	↓	↓
M123A13BxB394K_	394,000	↓	↓	↓
M123A13BxB474K_	474,000	↓	↓	↓
M123A13BxB105K_	1,000,000	K	BX	50

MIL-PRF-123/STYLE CKS55, -/21

Part Number 1/ (1206 Size Chip)	Capacitance pF	Capacitance Tolerance	Voltage- Temperature Limits	Rated Voltage
M123A21BPC1R0_	1.0	B, C	BP	100
M123A21BPC1R1_	1.1	↓	↓	↓
M123A21BPC1R2_	1.2			
M123A21BPC1R3_	1.3			
M123A21BPC1R5_	1.5			
M123A21BPC1R6_	1.6			
M123A21BPC1R8_	1.8			
M123A21BPC2R0_	2.0	↓	↓	↓
M123A21BPC2R2_	2.2			
M123A21BPC2R4_	2.4			
M123A21BPC2R7_	2.7			
M123A21BPC3R0_	3.0	↓	↓	↓
M123A21BPC3R3_	3.3			
M123A21BPC3R6_	3.6			
M123A21BPC3R9_	3.9			
M123A21BPC4R3_	4.3			
M123A21BPC4R7_	4.7	↓	↓	↓
M123A21BPC5R1_	5.1			
M123A21BPC5R6_	5.6			
M123A21BPC6R2_	6.2			
M123A21BPC6R8_	6.8			
M123A21BPC7R5_	7.5			
M123A21BPC8R2_	8.2			
M123A21BPC9R1_	9.1			
		B, C, D	BP	100

Part Number 1/ (1206 Size Chip)	Capacitance pF	Capacitance Tolerance	Voltage- Temperature Limits	Rated Voltage
M123A21BPC100_	10	↓	↓	↓
M123A21BPC110_	11			
M123A21BPC120_	12			
M123A21BPC130_	13			
M123A21BPC150_	15			
M123A21BPC160_	16			
M123A21BPC180_	18			
M123A21BPC200_	20			
M123A21BPC240_	24			
M123A21BPC270_	27			
M123A21BPC330_	33			
M123A21BPC360_	36			
M123A21BPC390_	39			
M123A21BPC430_	43			
M123A21BPC470_	47			
M123A21BPC510_	51			
M123A21BPC560_	56			
M123A21BPC620_	62			
M123A21BPC680_	68			
M123A21BPC750_	75			
M123A21BPC820_	82			
M123A21BPC910_	91			
M123A21BPC101_	100	F, J, K	BP	100

MIL-PRF-123/STYLE CKS55, -/21

Part Number 1/ (1206 Size Chip)	Capacitance pF	Capacitance Tolerance	Voltage- Temperature Limits	Rated Voltage
M123A21BPC111_	110	↓	↓	↓
M123A21BPC121_	120			
M123A21BPC131_	130			
M123A21BPC151_	150			
M123A21BPC161_	160			
M123A21BPC181_	180			
M123A21BPC201_	200			
M123A21BPC221_	220			
M123A21BPC241_	240			
M123A21BPC271_	270			
M123A21BPC301_	300			
M123A21BPC331_	330			
M123A21BPC361_	360			
M123A21BPC391_	390			
M123A21BPC431_	430			
M123A21BPC471_	470			
M123A21BPC511_	510			
M123A21BPC561_	560			
M123A21BPC621_	620			
M123A21BPC681_	680			
M123A21BPC751_	750			
M123A21BPC821_	820			
M123A21BPC911_	910			
M123A21BPC102_	1,000	F, J, K	BP	100

Part Number 1/ (1206 Size Chip)	Capacitance pF	Capacitance Tolerance	Voltage- Temperature Limits	Rated Voltage
M123A21BPB112_	1,100	↓	↓	↓
M123A21BPB122_	1,200			
M123A21BPB132_	1,300			
M123A21BPB152_	1,500			
M123A21BPB162_	1,600			
M123A21BPB182_	1,800			
M123A21BPB202_	2,000			
M123A21BPB222_	2,200	F, J, K	BP	50
M123A21BXC472_	4,700	↓	↓	↓
M123A21BXC562_	5,600			
M123A21BXC682_	6,800			
M123A21BXC822_	8,200			
M123A21BXC103_	10,000			
M123A21BXC123_	12,000			
M123A21BXC153_	15,000	K, M	BX	100
M123A21BXB183_	18,000	↓	↓	↓
M123A21BXB223_	22,000			
M123A21BXB273_	27,000			
M123A21BXB333_	33,000			
M123A21BXB393_	39,000			
		K, M	BX	50

MIL-PRF-123/STYLE CKS56, -/22

Part Number 1/ (1812 Size Chip)	Capacitance pF	Capacitance Tolerance	Voltage- Temperature Limits	Rated Voltage
M123A22BPC122__	1,200	F, J, K	BP	100
M123A22BPC152__	1,500	↓	↓	↓
M123A22BPC182__	1,800	↓	↓	↓
M123A22BPC222__	2,200	↓	↓	↓
M123A22BPC242__	2,400	↓	↓	↓
M123A22BPC272__	2,700	↓	↓	↓
M123A22BPC302__	3,000	↓	↓	↓
M123A22BPC332__	3,300	↓	↓	↓
M123A22BPC362__	3,600	↓	↓	↓
M123A22BPC392__	3,900	↓	↓	↓
M123A22BPC432__	4,300	↓	↓	↓
M123A22BPC472__	4,700	F, J, K	BP	100
M123A22BPB512__	5,100	F, J, K	BP	50
M123A22BPB562__	5,600	↓	↓	↓
M123A22BPB622__	6,200	↓	↓	↓
M123A22BPB682__	6,800	↓	↓	↓
M123A22BPB752__	7,500	↓	↓	↓
M123A22BPB822__	8,200	↓	↓	↓
M123A22BPB912__	9,100	↓	↓	↓
M123A22BPB103__	10,000	F, J, K	BP	50

Part Number 1/ (1812 Size Chip)	Capacitance pF	Capacitance Tolerance	Voltage- Temperature Limits	Rated Voltage
M123A22BXC273__	27,000	K, M	BX	100
M123A22BXC333__	33,000	↓	↓	↓
M123A22BXC393__	39,000	↓	↓	↓
M123A22BXC473__	47,000	↓	↓	↓
M123A22BXC563__	56,000	K, M	BX	100
M123A22BXC823__	82,000	K, M	BX	50
M123A22BXC104__	100,000	↓	↓	↓
M123A22BXC124__	120,000	↓	↓	↓
M123A22BXC154__	150,000	↓	↓	↓
M123A22BXC184__	180,000	K, M	BX	50

MIL-PRF-123/STYLE CKS57, -/23

Part Number 1/ (1825 Size Chip)	Capacitance pF	Capacitance Tolerance	Voltage- Temperature Limits	Rated Voltage
M123A23BPC392__	3,900	F, J, K	BP	100
M123A23BPC472__	4,700	↓	↓	↓
M123A23BPC512__	5,100	↓	↓	↓
M123A23BPC562__	5,600	↓	↓	↓
M123A23BPC622__	6,200	↓	↓	↓
M123A23BPC682__	6,800	↓	↓	↓
M123A23BPC752__	7,500	↓	↓	↓
M123A23BPC822__	8,200	↓	↓	↓
M123A23BPC912__	9,100	↓	↓	↓
M123A23BPC103__	10,000	F, J, K	BP	100
M123A23BPB113__	11,000	F, J, K	BP	50
M123A23BPB123__	12,000	↓	↓	↓
M123A23BPB133__	13,000	↓	↓	↓
M123A23BPB153__	15,000	↓	↓	↓
M123A23BPB163__	16,000	↓	↓	↓
M123A23BPB183__	18,000	↓	↓	↓
M123A23BPB203__	20,000	↓	↓	↓
M123A23BPB223__	22,000	F, J, K	BP	50

Part Number 1/ (1825 Size Chip)	Capacitance pF	Capacitance Tolerance	Voltage- Temperature Limits	Rated Voltage
M123A23BXC563__	56,000	K, M	BX	100
M123A23BXC683__	68,000	↓	↓	↓
M123A23BXC823__	82,000	↓	↓	↓
M123A23BXC104__	100,000	↓	↓	↓
M123A23BXC124__	120,000	↓	↓	↓
M123A23BXC154__	150,000	K, M	BX	100
M123A23BXC184__	180,000	K, M	BX	50
M123A23BXC224__	220,000	↓	↓	↓
M123A23BXC274__	270,000	↓	↓	↓
M123A23BXC334__	330,000	↓	↓	↓
M123A23BXC394__	390,000	↓	↓	↓
M123A23BXC474__	470,000	K, M	BX	50

High Voltage MLC Chips



For 600V to 5000V Applications

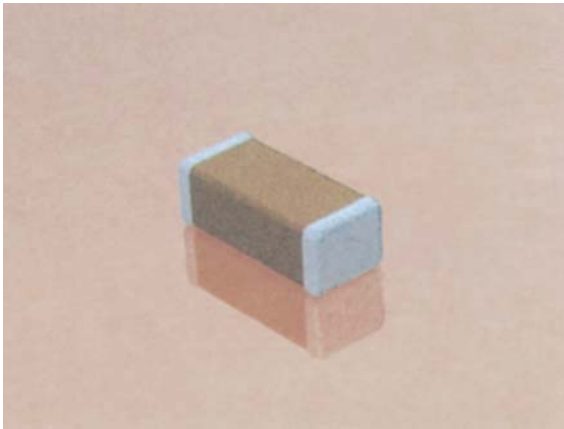

High value, low leakage and small size are difficult parameters to obtain in capacitors for high voltage systems. AVX special high voltage MLC chip capacitors meet these performance characteristics and are designed for applications such as snubbers in high frequency power converters, resonators in SMPS, and high voltage coupling/dc blocking. These high voltage chip designs exhibit low ESRs at high frequencies.

Larger physical sizes than normally encountered chips are used to make high voltage MLC chip products. Special precautions must be taken in applying these chips in surface mount assemblies. The temperature gradient during heating or cooling cycles should not exceed 4°C per second. The preheat temperature must be within 50°C of the peak temperature reached by the ceramic bodies through the soldering process. Chip sizes 1210 and larger should be reflow soldered only. Capacitors may require protective surface coating to prevent external arcing.

For 1825, 2225 and 3640 sizes, AVX offers leaded version in either thru-hole or SMT configurations (for details see section on high voltage leaded MLC chips).

NEW 630V RANGE

HOW TO ORDER

1808	A	A	271	K	A	1	1	A
AVX Style	Voltage	Temperature Coefficient	Capacitance Code (2 significant digits + no. of zeros) Examples:	Capacitance Tolerance COG: J = ±5% K = ±10% M = ±20% X7R: K = ±10% M = ±20% Z = +80%, -20%	Test Level A = Standard	Termination* 1 = Pd/Ag T = Plated Ni and Sn (RoHS Compliant)	Packaging 1 = 7" Reel** 3 = 13" Reel 9 = Bulk	Special Code A = Standard
0805	600V/630V = C	C0G = A	10 pF = 100					
1206	1000V = A	X7R = C	100 pF = 101					
1210	1500V = S		1,000 pF = 102					
1808	2000V = G		22,000 pF = 223					
1812	2500V = W		220,000 pF = 224					
1825	3000V = H		1 μF = 105					
2220	4000V = J							
2225	5000V = K							
3640								

Note: Terminations with 5% minimum lead (Pb) is available, see pages 94 and 95 for LD style. Leaded terminations are available, see pages 96 and 97.

Notes: Capacitors with X7R dielectrics are not intended for applications across AC supply mains or AC line filtering with polarity reversal. Contact plant for recommendations. Contact factory for availability of Termination and Tolerance options for Specific Part Numbers.

** The 3640 Style is not available on 7" Reels.

*** AVX offers nonstandard chip sizes. Contact factory for details.

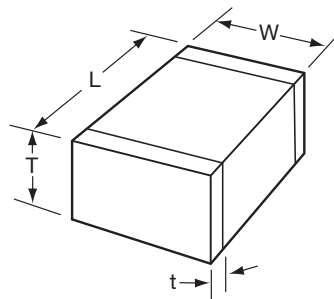

DIMENSIONS

millimeters (inches)

SIZE	0805	1206	1210*	1808*	1812*	1825*	2220*	2225*	3640*
(L) Length	2.01 ± 0.20 (0.079 ± 0.008)	3.20 ± 0.20 (0.126 ± 0.008)	3.20 ± 0.20 (0.126 ± 0.008)	4.57 ± 0.25 (0.180 ± 0.010)	4.50 ± 0.30 (0.177 ± 0.012)	4.50 ± 0.30 (0.177 ± 0.012)	5.70 ± 0.40 (0.224 ± 0.016)	5.72 ± 0.25 (0.225 ± 0.010)	9.14 ± 0.25 (0.360 ± 0.010)
(W) Width	1.25 ± 0.20 (0.049 ± 0.008)	1.60 ± 0.20 (0.063 ± 0.008)	2.50 ± 0.20 (0.098 ± 0.008)	2.03 ± 0.25 (0.080 ± 0.010)	3.20 ± 0.20 (0.126 ± 0.008)	6.40 ± 0.30 (0.252 ± 0.012)	5.00 ± 0.40 (0.197 ± 0.016)	6.35 ± 0.25 (0.250 ± 0.010)	10.2 ± 0.25 (0.400 ± 0.010)
(T) Thickness Max.	1.30 (0.051)	1.52 (0.060)	1.70 (0.067)	2.03 (0.080)	2.54 (0.100)	2.54 (0.100)	3.30 (0.130)	2.54 (0.100)	2.54 (0.100)
(t) terminal min. max.	0.50 ± 0.25 (0.020 ± 0.010)	0.25 (0.010) 0.75 (0.030)	0.25 (0.010) 0.75 (0.030)	0.25 (0.010) 1.02 (0.040)	0.25 (0.010) 1.02 (0.040)	0.25 (0.010) 1.02 (0.040)	0.25 (0.010) 1.02 (0.040)	0.25 (0.010) 1.02 (0.040)	0.76 (0.030) 1.52 (0.060)

*Reflow Soldering Only



High Voltage MLC Chips



For 600V to 5000V Applications

C0G Dielectric

Performance Characteristics

Capacitance Range	10 pF to 0.047 μ F (25°C, 1.0 \pm 0.2 Vrms at 1kHz, for \leq 1000 pF use 1 MHz)
Capacitance Tolerances	\pm 5%, \pm 10%, \pm 20%
Dissipation Factor	0.1% max. (+25°C, 1.0 \pm 0.2 Vrms, 1kHz, for \leq 1000 pF use 1 MHz)
Operating Temperature Range	-55°C to +125°C
Temperature Characteristic	0 \pm 30 ppm/°C (0 VDC)
Voltage Ratings	600, 630, 1000, 1500, 2000, 2500, 3000, 4000 & 5000 VDC (+125°C)
Insulation Resistance (+25°C, at 500 VDC)	100K M Ω min. or 1000 M Ω - μ F min., whichever is less
Insulation Resistance (+125°C, at 500 VDC)	10K M Ω min. or 100 M Ω - μ F min., whichever is less
Dielectric Strength	Minimum 120% rated voltage for 5 seconds at 50 mA max. current

HIGH VOLTAGE C0G CAPACITANCE VALUES

VOLTAGE	0805	1206	1210	1808	1812	1825	2220	2225	3640	
600/630	min.	10pF	10 pF	100 pF	100 pF	100 pF	1000 pF	1000 pF	1000 pF	1000 pF
	max.	330pF	1200 pF	2700 pF	3300 pF	5600 pF	0.012 μ F	0.012 μ F	0.018 μ F	0.047 μ F
1000	min.	10pF	10 pF	10 pF	100 pF	100 pF	100 pF	1000 pF	1000 pF	1000 pF
	max.	180pF	560 pF	1500 pF	2200 pF	3300 pF	8200 pF	0.010 μ F	0.010 μ F	0.022 μ F
1500	min.	—	10 pF	10 pF	10 pF	10 pF	100 pF	100 pF	100 pF	100 pF
	max.	—	270 pF	680 pF	820 pF	1800 pF	4700 pF	4700 pF	5600 pF	0.010 μ F
2000	min.	—	10 pF	10 pF	10 pF	10 pF	100 pF	100 pF	100 pF	100 pF
	max.	—	120 pF	270 pF	330 pF	1000 pF	1800 pF	2200 pF	2700 pF	6800 pF
2500	min.	—	—	—	10 pF	10 pF	10 pF	100 pF	100 pF	100 pF
	max.	—	—	—	180 pF	470 pF	1200 pF	1500 pF	1800 pF	3900 pF
3000	min.	—	—	—	10 pF	10 pF	10 pF	10 pF	10 pF	100 pF
	max.	—	—	—	120 pF	330 pF	820 pF	1000 pF	1200 pF	2700 pF
4000	min.	—	—	—	10 pF	10 pF	10 pF	10 pF	10 pF	100 pF
	max.	—	—	—	47 pF	150 pF	330 pF	470 pF	560 pF	1200 pF
5000	min.	—	—	—	—	—	—	10 pF	10 pF	10 pF
	max.	—	—	—	—	—	—	220 pF	270 pF	820 pF

X7R Dielectric

Performance Characteristics

Capacitance Range	10 pF to 0.56 μ F (25°C, 1.0 \pm 0.2 Vrms at 1kHz)
Capacitance Tolerances	\pm 10%; \pm 20%; +80%, -20%
Dissipation Factor	2.5% max. (+25°C, 1.0 \pm 0.2 Vrms, 1kHz)
Operating Temperature Range	-55°C to +125°C
Temperature Characteristic	\pm 15% (0 VDC)
Voltage Ratings	600, 630, 1000, 1500, 2000, 2500, 3000, 4000 & 5000 VDC (+125°C)
Insulation Resistance (+25°C, at 500 VDC)	100K M Ω min. or 1000 M Ω - μ F min., whichever is less
Insulation Resistance (+125°C, at 500 VDC)	10K M Ω min. or 100 M Ω - μ F min., whichever is less
Dielectric Strength	Minimum 120% rated voltage for 5 seconds at 50 mA max. current

HIGH VOLTAGE X7R MAXIMUM CAPACITANCE VALUES

VOLTAGE	0805	1206	1210	1808	1812	1825	2220	2225	3640	
600/630	min.	100pF	1000 pF	1000 pF	1000 pF	1000 pF	0.010 μ F	0.010 μ F	0.010 μ F	0.010 μ F
	max.	6800pF	0.022 μ F	0.056 μ F	0.068 μ F	0.120 μ F	0.270 μ F	0.270 μ F	0.330 μ F	0.560 μ F
1000	min.	100pF	100 pF	1000 pF	1000 pF	1000 pF	1000 pF	1000 pF	1000 pF	1000 pF
	max.	1500pF	6800 pF	0.015 μ F	0.018 μ F	0.039 μ F	0.100 μ F	0.120 μ F	0.150 μ F	0.220 μ F
1500	min.	—	100 pF	100 pF	100 pF	100 pF	1000 pF	1000 pF	1000 pF	1000 pF
	max.	—	2700 pF	5600 pF	6800 pF	0.015 μ F	0.056 μ F	0.056 μ F	0.068 μ F	0.100 μ F
2000	min.	—	10 pF	100 pF	100 pF	100 pF	100 pF	1000 pF	1000 pF	1000 pF
	max.	—	1500 pF	3300 pF	3300 pF	8200 pF	0.022 μ F	0.027 μ F	0.033 μ F	0.027 μ F
2500	min.	—	—	—	10 pF	10 pF	100 pF	100 pF	100 pF	1000 pF
	max.	—	—	—	2200 pF	5600 pF	0.015 μ F	0.018 μ F	0.022 μ F	0.022 μ F
3000	min.	—	—	—	10 pF	10 pF	100 pF	100 pF	100 pF	1000 pF
	max.	—	—	—	1800 pF	3900 pF	0.010 μ F	0.012 μ F	0.015 μ F	0.018 μ F
4000	min.	—	—	—	—	—	—	—	—	100 pF
	max.	—	—	—	—	—	—	—	—	6800 pF
5000	min.	—	—	—	—	—	—	—	—	100 pF
	max.	—	—	—	—	—	—	—	—	3300 pF

High Voltage MLC Chips Tin/Lead Termination "B"



For 600V to 5000V Applications

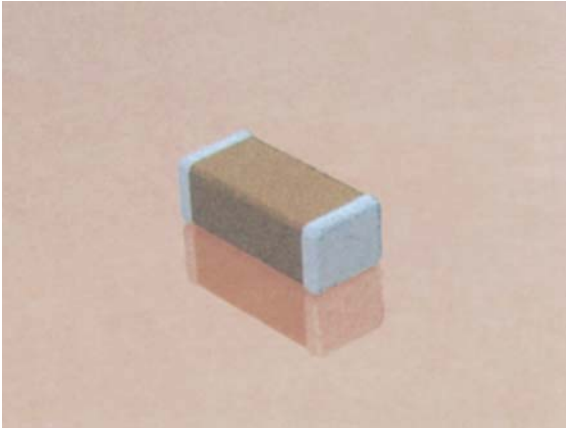

NEW 630V RANGE

AVX Corporation will support those customers for commercial and military Multilayer Ceramic Capacitors with a termination consisting of 5% minimum lead. This termination is indicated by the use of a "B" in the 12th position of the AVX Catalog Part Number. This fulfills AVX's commitment to providing a full range of products to our customers. AVX has provided in the following pages, a full range of values that we are offering in this "B" termination.

Larger physical sizes than normally encountered chips are used to make high voltage MLC chip product. Special precautions must be taken in applying these chips in surface mount assemblies. The temperature gradient during heating or cooling cycles should not exceed 4°C per second. The preheat temperature must be within 50°C of the peak temperature reached by the ceramic bodies through the soldering process. Chip sizes 1210 and larger should be reflow soldered only. Capacitors may require protective surface coating to prevent external arcing.

For 1825, 2225 and 3640 sizes, AVX offers leaded version in either thru-hole or SMT configurations (for details see section on high voltage leaded MLC chips).

HOW TO ORDER

LD08	A	A	271	K	A	B	1	A
AVX Style	Voltage	Temperature Coefficient	Capacitance Code (2 significant digits + no. of zeros) Examples: 10 pF = 100 100 pF = 101 1,000 pF = 102 22,000 pF = 223 220,000 pF = 224 1 μF = 105	Capacitance Tolerance COG: J = ±5% K = ±10% M = ±20% X7R: K = ±10% M = ±20% Z = +80%, -20%	Test Level A = Standard	Termination B = 5% Min Pb X = FLEXITERM® with 5% min. Pb*	Packaging 1 = 7" Reel** 3 = 13" Reel 9 = Bulk	Special Code A = Standard
LD05 - 0805	600V/630V = C 1000V = A	COG = A X7R = C						
LD06 - 1206	1500V = S							
LD10 - 1210	2000V = G							
LD08 - 1808	2500V = W							
LD12 - 1812	3000V = H							
LD13 - 1825	4000V = J							
LD20 - 2220	5000V = K							
LD14 - 2225								
LD40 - 3640								

Notes: Capacitors with X7R dielectrics are not intended for applications across AC supply mains or AC line filtering with polarity reversal. Contact plant for recommendations. Contact factory for availability of Termination and Tolerance options for Specific Part Numbers.

- * FLEXITERM is not available in the LD40 Style
- ** The 3640 Style is not available on 7" Reels.
- *** AVX offers nonstandard chip sizes. Contact factory for details.

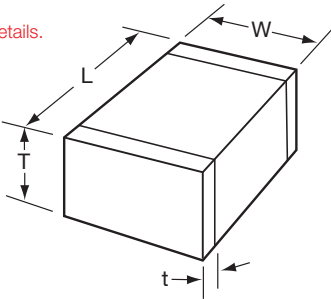

DIMENSIONS

millimeters (inches)

SIZE	LD05 (0805)	LD06 (1206)	LD10* (1210)	LD08* (1808)	LD12* (1812)	LD13* (1825)	LD20* (2220)	LD14* (2225)	LD40* (3640)
(L) Length	2.01 ± 0.20 (0.079 ± 0.008)	3.20 ± 0.20 (0.126 ± 0.008)	3.20 ± 0.20 (0.126 ± 0.008)	4.57 ± 0.25 (0.180 ± 0.010)	4.50 ± 0.30 (0.177 ± 0.012)	4.50 ± 0.30 (0.177 ± 0.012)	5.70 ± 0.40 (0.224 ± 0.016)	5.72 ± 0.25 (0.225 ± 0.010)	9.14 ± 0.25 (0.360 ± 0.010)
(W) Width	1.25 ± 0.20 (0.049 ± 0.008)	1.60 ± 0.20 (0.063 ± 0.008)	2.50 ± 0.20 (0.098 ± 0.008)	2.03 ± 0.25 (0.080 ± 0.010)	3.20 ± 0.20 (0.126 ± 0.008)	6.40 ± 0.30 (0.252 ± 0.012)	5.00 ± 0.40 (0.197 ± 0.016)	6.35 ± 0.25 (0.250 ± 0.010)	10.2 ± 0.25 (0.400 ± 0.010)
(T) Thickness Max.	1.30 (0.051)	1.52 (0.060)	1.70 (0.067)	2.03 (0.080)	2.54 (0.100)	2.54 (0.100)	3.30 (0.130)	2.54 (0.100)	2.54 (0.100)
(t) terminal min. max.	0.50 ± 0.25 (0.020 ± 0.010)	0.25 (0.010) 0.75 (0.030)	0.25 (0.010) 0.75 (0.030)	0.25 (0.010) 1.02 (0.040)	0.25 (0.010) 1.02 (0.040)	0.25 (0.010) 1.02 (0.040)	0.25 (0.010) 1.02 (0.040)	0.25 (0.010) 1.02 (0.040)	0.76 (0.030) 1.52 (0.060)

* Reflow soldering only.



High Voltage MLC Chips Tin/Lead Termination “B”



For 600V to 5000V Applications

C0G Dielectric Performance Characteristics

Capacitance Range	10 pF to 0.047 μ F (25°C, 1.0 \pm 0.2 Vrms at 1kHz, for \leq 1000 pF use 1 MHz)
Capacitance Tolerances	\pm 5%, \pm 10%, \pm 20%
Dissipation Factor	0.1% max. (+25°C, 1.0 \pm 0.2 Vrms, 1kHz, for \leq 1000 pF use 1 MHz)
Operating Temperature Range	-55°C to +125°C
Temperature Characteristic	0 \pm 30 ppm/°C (0 VDC)
Voltage Ratings	600, 630, 1000, 1500, 2000, 2500, 3000, 4000 & 5000 VDC (+125°C)
Insulation Resistance (+25°C, at 500 VDC)	100K M Ω min. or 1000 M Ω - μ F min., whichever is less
Insulation Resistance (+125°C, at 500 VDC)	10K M Ω min. or 100 M Ω - μ F min., whichever is less
Dielectric Strength	Minimum 120% rated voltage for 5 seconds at 50 mA max. current

HIGH VOLTAGE C0G CAPACITANCE VALUES

VOLTAGE	LD05 (0805)	LD06 (1206)	LD10 (1210)	LD08 (1808)	LD12 (1812)	LD13 (1825)	LD20 (2220)	LD14 (2225)	LD40 (3640)
600/630 min.	10pF	10 pF	100 pF	100 pF	100 pF	1000 pF	1000 pF	1000 pF	1000 pF
600/630 max.	330pF	1200 pF	2700 pF	3300 pF	5600 pF	0.012 μ F	0.012 μ F	0.018 μ F	0.047 μ F
1000 min.	10pF	10 pF	10 pF	100 pF	100 pF	100 pF	1000 pF	1000 pF	1000 pF
1000 max.	180pF	560 pF	1500 pF	2200 pF	3300 pF	8200 pF	0.010 μ F	0.010 μ F	0.022 μ F
1500 min.	—	10 pF	10 pF	10 pF	10 pF	100 pF	100 pF	100 pF	100 pF
1500 max.	—	270 pF	680 pF	820 pF	1800 pF	4700 pF	4700 pF	5600 pF	0.010 μ F
2000 min.	—	10 pF	10 pF	10 pF	10 pF	100 pF	100 pF	100 pF	100 pF
2000 max.	—	120 pF	270 pF	330 pF	1000 pF	1800 pF	2200 pF	2700 pF	6800 pF
2500 min.	—	—	—	10 pF	10 pF	10 pF	100 pF	100 pF	100 pF
2500 max.	—	—	—	180 pF	470 pF	1200 pF	1500 pF	1800 pF	3900 pF
3000 min.	—	—	—	10 pF	10 pF	10 pF	10 pF	10 pF	100 pF
3000 max.	—	—	—	120 pF	330 pF	820 pF	1000 pF	1200 pF	2700 pF

X7R Dielectric Performance Characteristics

Capacitance Range	10 pF to 0.56 μ F (25°C, 1.0 \pm 0.2 Vrms at 1kHz)
Capacitance Tolerances	\pm 10%; \pm 20%; +80%, -20%
Dissipation Factor	2.5% max. (+25°C, 1.0 \pm 0.2 Vrms, 1kHz)
Operating Temperature Range	-55°C to +125°C
Temperature Characteristic	\pm 15% (0 VDC)
Voltage Ratings	600, 630, 1000, 1500, 2000, 2500, 3000, 4000 & 5000 VDC (+125°C)
Insulation Resistance (+25°C, at 500 VDC)	100K M Ω min. or 1000 M Ω - μ F min., whichever is less
Insulation Resistance (+125°C, at 500 VDC)	10K M Ω min. or 100 M Ω - μ F min., whichever is less
Dielectric Strength	Minimum 120% rated voltage for 5 seconds at 50 mA max. current

HIGH VOLTAGE X7R MAXIMUM CAPACITANCE VALUES

VOLTAGE	0805	1206	1210	1808	1812	1825	2220	2225	3640
600/630 min.	100pF	1000 pF	1000 pF	1000 pF	1000 pF	0.010 μ F	0.010 μ F	0.010 μ F	0.010 μ F
600/630 max.	6800pF	0.022 μ F	0.056 μ F	0.068 μ F	0.120 μ F	0.270 μ F	0.270 μ F	0.330 μ F	0.560 μ F
1000 min.	100pF	100 pF	1000 pF	1000 pF	1000 pF	1000 pF	1000 pF	1000 pF	0.010 μ F
1000 max.	1500pF	6800 pF	0.015 μ F	0.018 μ F	0.039 μ F	0.100 μ F	0.120 μ F	0.150 μ F	0.220 μ F
1500 min.	—	100 pF	100 pF	100 pF	100 pF	1000 pF	1000 pF	1000 pF	1000 pF
1500 max.	—	2700 pF	5600 pF	6800 pF	0.015 μ F	0.056 μ F	0.056 μ F	0.068 μ F	0.100 μ F
2000 min.	—	10 pF	100 pF	100 pF	100 pF	100 pF	1000 pF	1000 pF	1000 pF
2000 max.	—	1500 pF	3300 pF	3300 pF	8200 pF	0.022 μ F	0.027 μ F	0.033 μ F	0.027 μ F
2500 min.	—	—	—	10 pF	10 pF	100 pF	100 pF	100 pF	1000 pF
2500 max.	—	—	—	2200 pF	5600 pF	0.015 μ F	0.018 μ F	0.022 μ F	0.022 μ F
3000 min.	—	—	—	10 pF	10 pF	100 pF	100 pF	100 pF	1000 pF
3000 max.	—	—	—	1800 pF	3900 pF	0.010 μ F	0.012 μ F	0.015 μ F	0.018 μ F
4000 min.	—	—	—	—	—	—	—	—	100 pF
4000 max.	—	—	—	—	—	—	—	—	6800 pF
5000 min.	—	—	—	—	—	—	—	—	100 pF
5000 max.	—	—	—	—	—	—	—	—	3300 pF

High Voltage MLC Chips FLEXITERM®



For 600V to 3000V Applications

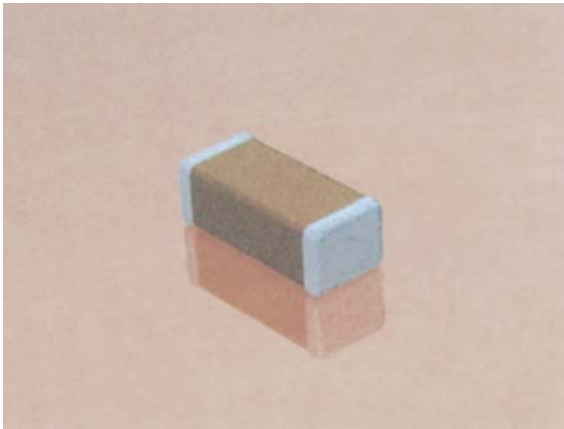

High value, low leakage and small size are difficult parameters to obtain in capacitors for high voltage systems. AVX special high voltage MLC chips capacitors meet these performance characteristics and are designed for applications such as snubbers in high frequency power converters, resonators in SMPS, and high voltage coupling/DC blocking. These high voltage chip designs exhibit low ESRs at high frequencies.

To make high voltage chips, larger physical sizes than are normally encountered are necessary. These larger sizes require that special precautions be taken in applying these chips in surface mount assemblies. In response to this, and to follow from the success of the FLEXITERM® range of low voltage parts, AVX is delighted to offer a FLEXITERM® high voltage range of capacitors, FLEXITERM®.

The FLEXITERM® layer is designed to enhance the mechanical flexure and temperature cycling performance of a standard ceramic capacitor, giving customers a solution where board flexure or temperature cycle damage are concerns.

HOW TO ORDER

1808	A	C	272	K	A	Z	1	A
AVX Style	Voltage	Temperature Coefficient	Capacitance Code (2 significant digits + no. of zeros) Examples:	Capacitance Tolerance COG: J = ±5% K = ±10% M = ±20% X7R: K = ±10% M = ±20% Z = +80%, -20%	Test Level	Termination* Z = FLEXITERM® 100% Tin (RoHS Compliant)	Packaging 1 = 7" Reel 3 = 13" Reel 9 = Bulk	Special Code A = Standard
0805	600V/630V = C 1000V = A 1500V = S 2000V = G 2500V = W 3000V = H	COG = A X7R = C	10 pF = 100 100 pF = 101 1,000 pF = 102 22,000 pF = 223 220,000 pF = 224 1 µF = 105					
1206								
1210								
1808								
1812								
1825								
2220								
2225								

Notes: Capacitors with X7R dielectrics are not intended for applications across AC supply mains or AC line filtering with polarity reversal. Contact plant for recommendations. Contact factory for availability of Termination and Tolerance options for Specific Part Numbers.

*** AVX offers nonstandard chip sizes. Contact factory for details.

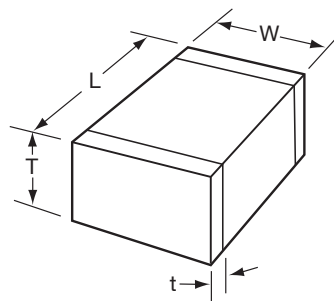

DIMENSIONS

millimeters (inches)

SIZE	0805	1206	1210*	1808*	1812*	1825*	2220*	2225*
(L) Length	2.01 ± 0.20 (0.079 ± 0.008)	3.20 ± 0.20 (0.126 ± 0.008)	3.20 ± 0.20 (0.126 ± 0.008)	4.57 ± 0.25 (0.180 ± 0.010)	4.50 ± 0.30 (0.177 ± 0.012)	4.50 ± 0.30 (0.177 ± 0.012)	5.7 ± 0.40 (0.224 ± 0.016)	5.72 ± 0.25 (0.225 ± 0.010)
(W) Width	1.25 ± 0.20 (0.049 ± 0.008)	1.60 ± 0.20 (0.063 ± 0.008)	2.50 ± 0.20 (0.098 ± 0.008)	2.03 ± 0.25 (0.080 ± 0.010)	3.20 ± 0.20 (0.126 ± 0.008)	6.40 ± 0.30 (0.252 ± 0.012)	5.0 ± 0.40 (0.197 ± 0.016)	6.35 ± 0.25 (0.250 ± 0.010)
(T) Thickness Max.	1.30 (0.051)	1.52 (0.060)	1.70 (0.067)	2.03 (0.080)	2.54 (0.100)	2.54 (0.100)	3.30 (0.130)	2.54 (0.100)
(t) terminal min. max.	0.50 ± 0.25 (0.020 ± 0.010)	0.25 (0.010) 0.75 (0.030)	0.25 (0.010) 0.75 (0.030)	0.25 (0.010) 1.02 (0.040)	0.25 (0.010) 1.02 (0.040)	0.25 (0.010) 1.02 (0.040)	0.25 (0.010) 1.02 (0.040)	0.25 (0.010) 1.02 (0.040)

*Reflow Soldering Only



High Voltage MLC Chips FLEXITERM®



For 600V to 5000V Applications

C0G Dielectric

Performance Characteristics

Capacitance Range	10 pF to 0.018 μ F (25°C, 1.0 \pm 0.2 Vrms at 1kHz, for \leq 1000 pF use 1 MHz)
Capacitance Tolerances	\pm 5%, \pm 10%, \pm 20%
Dissipation Factor	0.1% max. (+25°C, 1.0 \pm 0.2 Vrms, 1kHz, for \leq 1000 pF use 1 MHz)
Operating Temperature Range	-55°C to +125°C
Temperature Characteristic	0 \pm 30 ppm/°C (0 VDC)
Voltage Ratings	600, 630, 1000, 1500, 2000, 2500, 3000, 4000 & 5000 VDC (+125°C)
Insulation Resistance (+25°C, at 500 VDC)	100K M Ω min. or 1000 M Ω - μ F min., whichever is less
Insulation Resistance (+125°C, at 500 VDC)	10K M Ω min. or 100 M Ω - μ F min., whichever is less
Dielectric Strength	Minimum 120% rated voltage for 5 seconds at 50 mA max. current

HIGH VOLTAGE C0G CAPACITANCE VALUES

VOLTAGE	0805	1206	1210	1808	1812	1825	2220	2225
600/630 min.	10pF	10 pF	100 pF	100 pF	100 pF	1000 pF	1000 pF	1000 pF
600/630 max.	330pF	1200 pF	2700 pF	3300 pF	5600 pF	0.012 μ F	0.012 μ F	0.018 μ F
1000 min.	10pF	10 pF	10 pF	100 pF	100 pF	100 pF	1000 pF	1000 pF
1000 max.	180pF	560 pF	1500 pF	2200 pF	3300 pF	8200 pF	0.010 μ F	0.010 μ F
1500 min.	—	10 pF	10 pF	10 pF	10 pF	100 pF	100 pF	100 pF
1500 max.	—	270 pF	680 pF	820 pF	1800 pF	4700 pF	4700 pF	5600 pF
2000 min.	—	10 pF	10 pF	10 pF	10 pF	100 pF	100 pF	100 pF
2000 max.	—	120 pF	270 pF	330 pF	1000 pF	1800 pF	2200 pF	2700 pF
2500 min.	—	—	—	10 pF	10 pF	10 pF	100 pF	100 pF
2500 max.	—	—	—	180 pF	470 pF	1200 pF	1500 pF	1800 pF
3000 min.	—	—	—	10 pF	10 pF	10 pF	10 pF	10 pF
3000 max.	—	—	—	120 pF	330 pF	820 pF	1000 pF	1200 pF
4000 min.	—	—	—	10 pF	10 pF	10 pF	10 pF	10 pF
4000 max.	—	—	—	47 pF	150 pF	330 pF	470 pF	560 pF
5000 min.	—	—	—	—	—	—	10 pF	10 pF
5000 max.	—	—	—	—	—	—	220 pF	270 pF

X7R Dielectric

Performance Characteristics

Capacitance Range	10 pF to 0.33 μ F (25°C, 1.0 \pm 0.2 Vrms at 1kHz)
Capacitance Tolerances	\pm 10%; \pm 20%; +80%, -20%
Dissipation Factor	2.5% max. (+25°C, 1.0 \pm 0.2 Vrms, 1kHz)
Operating Temperature Range	-55°C to +125°C
Temperature Characteristic	\pm 15% (0 VDC)
Voltage Ratings	600, 630, 1000, 1500, 2000, 2500, 3000, 4000 & 5000 VDC (+125°C)
Insulation Resistance (+25°C, at 500 VDC)	100K M Ω min. or 1000 M Ω - μ F min., whichever is less
Insulation Resistance (+125°C, at 500 VDC)	10K M Ω min. or 100 M Ω - μ F min., whichever is less
Dielectric Strength	Minimum 120% rated voltage for 5 seconds at 50 mA max. current

HIGH VOLTAGE X7R MAXIMUM CAPACITANCE VALUES

VOLTAGE	0805	1206	1210	1808	1812	1825	2220	2225
600/630 min.	100pF	1000 pF	1000 pF	1000 pF	1000 pF	0.010 μ F	0.010 μ F	0.010 μ F
600/630 max.	6800pF	0.022 μ F	0.056 μ F	0.068 μ F	0.120 μ F	0.270 μ F	0.270 μ F	0.330 μ F
1000 min.	100pF	100 pF	1000 pF	1000 pF	1000 pF	1000 pF	1000 pF	1000 pF
1000 max.	1500pF	6800 pF	0.015 μ F	0.018 μ F	0.039 μ F	0.100 μ F	0.120 μ F	0.150 μ F
1500 min.	—	100 pF	100 pF	100 pF	100 pF	1000 pF	1000 pF	1000 pF
1500 max.	—	2700 pF	5600 pF	6800 pF	0.015 μ F	0.056 μ F	0.056 μ F	0.068 μ F
2000 min.	—	10 pF	100 pF	100 pF	100 pF	100 pF	1000 pF	1000 pF
2000 max.	—	1500 pF	3300 pF	2300 pF	8200 pF	0.022 μ F	0.027 μ F	0.033 μ F
2500 min.	—	—	—	10 pF	10 pF	100 pF	100 pF	100 pF
2500 max.	—	—	—	2200 pF	5600 pF	0.015 μ F	0.018 μ F	0.022 μ F
3000 min.	—	—	—	10 pF	10 pF	100 pF	100 pF	100 pF
3000 max.	—	—	—	1800 pF	2200 pF	0.010 pF	0.012 μ F	0.015 μ F

High Voltage MLC Ledged Chips



For 600V to 5000V Applications

HOW TO ORDER

1825	A	A	271	K	A	V	00N
AVX Style	Voltage	Temperature Coefficient	Capacitance Code (2 significant digits + no. of zeros) Examples:	Capacitance Tolerance COG: J = ±5% K = ±10% M = ±20% X7R: K = ±10% M = ±20% Z = +80%, -20%	Test Level A = Standard	Finish V = Uncoated W = Epoxy Coated	Lead Style 00N = Straight Lead 00J = Leads Formed In 00L = Leads Formed Out
1825	600V/630V = C	C0G = A	10 pF = 100				
2225	1000V = A	X7R = C	100 pF = 101				
3640	1500V = S		1,000 pF = 102				
	2000V = G		22,000 pF = 223				
	2500V = W		220,000 pF = 224				
	3000V = H						
	4000V = J						
	5000V = K						

Note: Capacitors with X7R dielectrics are not intended for applications across AC supply mains or AC line filtering with polarity reversal. Contact plant for recommendations. Capacitors may require protective surface coating to prevent external arcing.

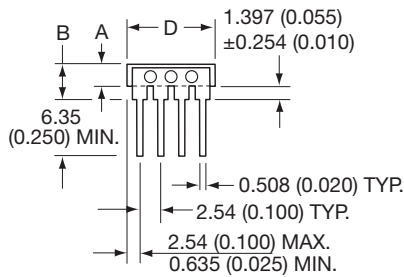

“N” STYLE LEADS

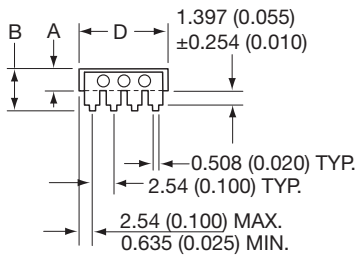
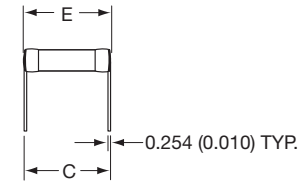

“J” STYLE LEADS

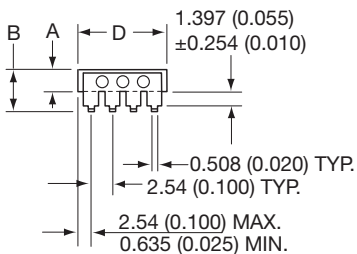
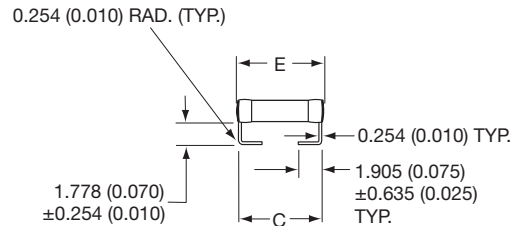

“L” STYLE LEADS

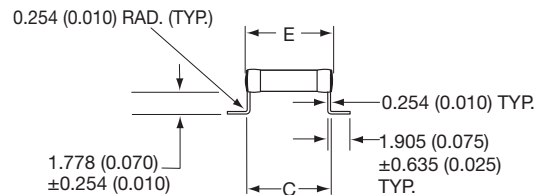

DIMENSIONS

millimeters (inches)

Style	A (max.)	B (max.)	C ±.635 (±0.025)	D ±.635 (±0.025)	E (max.)	No. of Leads per side
1825	2.54 (0.100)	For “N” Style Leads, “B” Dimension = 4.19 (0.165)	5.08 (0.200)	6.35 (0.250)	6.86 (0.270)	3
2225		For “J” & “L” Leads, “B” Dimension = 4.58 (0.180)	6.35 (0.250)	6.35 (0.250)	7.62 (0.300)	3
3640			10.2 (0.400)	10.2 (0.400)	11.2 (0.440)	4

Note: For W (Epoxy Coated) part add 0.127 (0.005) to max. and nominal dimensions A, B, D, & E



High Voltage MLC Leaded Chips



For 600V to 5000V Applications

C0G Dielectric

Performance Characteristics

Capacitance Range	10 pF to 0.047 μ F (25°C, 1.0 \pm 0.2 Vrms at 1kHz, for \leq 1000 pF use 1 MHz)
Capacitance Tolerances	\pm 5%, \pm 10%, \pm 20%
Dissipation Factor	0.15% max. (+25°C, 1.0 \pm 0.2 Vrms, 1kHz, for \leq 1000 pF use 1 MHz)
Operating Temperature Range	-55°C to +125°C
Temperature Characteristic	0 \pm 30 ppm/°C (0 VDC)
Voltage Ratings	600, 630, 1000, 1500, 2000, 2500, 3000, 4000 & 5000 VDC (+125°C)
Insulation Resistance (+25°C, at 500 VDC)	100K M Ω min. or 1000 M Ω - μ F min., whichever is less
Insulation Resistance (+125°C, at 500 VDC)	10K M Ω min. or 100 M Ω - μ F min., whichever is less
Dielectric Strength	Minimum 120% rated voltage for 5 seconds at 50 mA max. current

HIGH VOLTAGE C0G CAPACITANCE VALUES

VOLTAGE	1825	2225	3640
600/630 min.	1000 pF	1000 pF	1000 pF
600/630 max.	0.012 μ F	0.018 μ F	0.047 μ F
1000 min.	100 pF	1000 pF	1000 pF
1000 max.	8200 pF	0.010 μ F	0.022 μ F
1500 min.	100 pF	100 pF	100 pF
1500 max.	4700 pF	5600 pF	0.010 μ F
2000 min.	100 pF	100 pF	100 pF
2000 max.	1800 pF	2700 pF	6800 pF
2500 min.	10 pF	100 pF	100 pF
2500 max.	1200 pF	1800 pF	3900 pF
3000 min.	10 pF	10 pF	100 pF
3000 max.	8200 pF	1200 pF	2700 pF
4000 min.	10 pF	10 pF	100 pF
4000 max.	330 pF	560 pF	1200 pF
5000 min.	—	10 pF	10 pF
5000 max.	—	270 pF	820 pF

X7R Dielectric

Performance Characteristics

Capacitance Range	100 pF to 0.56 μ F (25°C, 1.0 \pm 0.2 Vrms at 1kHz)
Capacitance Tolerances	\pm 10%; \pm 20%; +80%, -20%
Dissipation Factor	2.5% max. (+25°C, 1.0 \pm 0.2 Vrms, 1kHz)
Operating Temperature Range	-55°C to +125°C
Temperature Characteristic	\pm 15% (0 VDC)
Voltage Ratings	600, 630, 1000, 1500, 2000, 2500, 3000, 4000 & 5000 VDC (+125°C)
Insulation Resistance (+25°C, at 500 VDC)	100K M Ω min. or 1000 M Ω - μ F min., whichever is less
Insulation Resistance (+125°C, at 500 VDC)	10K M Ω min. or 100 M Ω - μ F min., whichever is less
Dielectric Strength	Minimum 120% rated voltage for 5 seconds at 50 mA max. current

HIGH VOLTAGE X7R MAXIMUM CAPACITANCE VALUES

VOLTAGE	1825	2225	3640
600/630 min.	0.010 μ F	0.010 μ F	0.010 μ F
600/630 max.	0.270 μ F	0.330 μ F	0.560 μ F
1000 min.	1000 pF	1000 pF	0.010 μ F
1000 max.	0.100 μ F	0.150 μ F	0.220 μ F
1500 min.	1000 pF	1000 pF	1000 pF
1500 max.	0.056 μ F	0.068 μ F	0.100 μ F
2000 min.	100 pF	1000 pF	1000 pF
2000 max.	0.022 μ F	0.033 μ F	0.027 μ F
2500 min.	100 pF	100 pF	1000 pF
2500 max.	0.015 μ F	0.022 μ F	0.022 μ F
3000 min.	100 pF	100 pF	1000 pF
3000 max.	0.010 μ F	0.015 μ F	0.018 μ F
4000 min.	—	—	100 pF
4000 max.	—	—	6800 pF
5000 min.	—	—	100 pF
5000 max.	—	—	3300 pF

Hi-Q® High RF Power MLC Surface Mount Capacitors

For 600V to 7200V Applications



PRODUCT OFFERING

Hi-Q®, high RF power, surface mount MLC capacitors from AVX Corporation are characterized with ultra-low ESR and dissipation factor at high frequencies. They are designed to handle high power and high voltage levels for applications in RF power amplifiers, inductive heating, high magnetic field environments (MRI coils), medical and industrial electronics.

HOW TO ORDER

HQCC	A	A	271	J	A	T	1	A
AVX Style	Voltage	Temperature Coefficient	Capacitance Code (2 significant digits + no. of zeros) Examples: 4.7 pF = 4R7 10 pF = 100 100 pF = 101 1,000 pF = 102	Capacitance Tolerance C = ±0.25pF (<13pF) D = ±0.50pF (<25pF) F = ±1% (≥25pF) G = ±2% (≥13pF) J = ±5% K = ±10% M = ±20%	Test Level A = Standard	Termination* 1 = Pd/Ag T = Plated Ni and Sn (RoHS Compliant) J = 5% Min Pb	Packaging 1 = 7" Reel** 3 = 13" Reel 9 = Bulk	Special Code A = Standard
HQCC HQCE	600V/630V = C 1000V = A 1500V = S 2000V = G 2500V = W 3000V = H 4000V = J 5000V = K 7200V = M	COG = A						

Contact factory for availability of Termination and Tolerance options for Specific Part Numbers.
**The HQCE Style is not available on 7" reels.

DIMENSIONS millimeters (inches)

STYLE	HQCC	HQCE
(L) Length	5.84 ± 0.51 (0.230 ± 0.020)	9.4 ± 0.51 (0.370 ± 0.020)
(W) Width	6.35 ± 0.51 (0.250 ± 0.020)	9.9 ± 0.51 (0.390 ± 0.020)
(T) Thickness Max.	3.3 max. (0.130 max.)	3.3 max. (0.130 max.)
(t) terminal	0.64 ± 0.38 (0.025 ± 0.015)	0.64 ± 0.38 (0.025 ± 0.015)

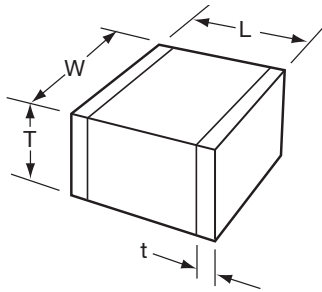

DIELECTRIC PERFORMANCE CHARACTERISTICS

Capacitance Range	3.3pF to 6,800pF (25°C, 1.0 ±0.2 Vrms at 1kHz, for ≤ 1000 pF use 1MHz)
Capacitance Tolerances	±0.25pF, ±0.50pF, ±1%, ±2%, ±5%, ±10%, ±20%
Dissipation Factor 25°C	0.1% Max (+25°C, 1.0 ±0.2 Vrms at 1kHz, for ≤ 1000 pF use 1MHz)
Operating Temperature Range	-55°C to +125°C
Temperature Characteristic	COG: 0 ± 30 ppm/°C (-55°C to +125°C)
Voltage Ratings	600, 630, 1000, 1500, 2000, 2500, 3000, 4000, 5000, 7200VDC
Insulation Resistance	100K MΩ min. @ +25°C and 500VDC 10K MΩ min. @ +125°C and 500VDC
Dielectric Strength	Minimum 120% of rated WVDC

HIGH VOLTAGE CAPACITANCE VALUES (pF)

Style	600/630 WDC min./max.	1000 WVDC min./max.	1500 WVDC min./max.	2000 WVDC min./max.	2500 WVDC min./max.	3000 WVDC min./max.	4000 WVDC min./max.	5000 WVDC min./max.	7200 WVDC min./max.
HQCC	2,200 - 2,700	1,500 - 1,800	820 - 1,200	470 - 680	330 - 390	3.3 - 270	3.3 - 6.8		
HQCE	3.3 - 6,800	3.3 - 4,700	3.3 - 2,700	3.3 - 1,800	3.3 - 1,000	3.3 - 680	3.3 - 390	3.3 - 180	3.3 - 100

Hi-Q® High RF Power Ribbon Leded MLC Capacitors

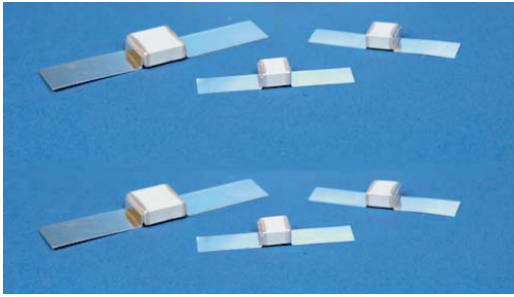

Hi-Q®, High RF Power, Ribbon Leded MLC Capacitors from AVX Corporation are characterized with ultra-low ESR and dissipation factor at high frequencies. The HQL-style parts are constructed using non-magnetic materials. They are designed to handle high power and high voltage levels for applications in RF power amplifiers, inductive heating, high magnetic field environments (MRI coils), medical and industrial electronics.

HOW TO ORDER

HQLC	A	A	271	J	A	A
AVX Style HQLC HQLE	Voltage 600V/630 = C 1000V = A 1500V = S 2000V = G 2500V = W 3000V = H 4000V = J 5000V = K 7200V = M	Temperature Coefficient COG = A	Capacitance Code (2 significant digits + no. of zeros) Examples: 4.7 pF = 4R7 10 pF = 100 100 pF = 101 1,000 pF = 102	Capacitance Tolerance C = ±0.25pF (<13pF) D = ±0.50pF (<25pF) F = ±1% (≥25pF) G = ±2% (≥13pF) J = ±5% K = ±10% M = ±20%	Test Level A = Standard	Lead Style A = Axial Ribbon M = Microstrip

Capacitance Range (pF)

Style	600/630 WVDC min./max.	1000 WVDC min./max.	1500 WVDC min./max.	2000 WVDC min./max.	2500 WVDC min./max.	3000 WVDC min./max.	4000 WVDC min./max.	5000 WVDC min./max.	7200 WVDC min./max.
HQLC	2200 - 2700	1500 - 1800	820 - 1200	470 - 680	330 - 390	3.3 - 270	3.3 - 6.8		
HQLE	3.3 - 6800	3.3 - 4700	3.3 - 2700	3.3 - 1800	3.3 - 1000	3.3 - 680	3.3 - 390	3.3 - 180	3.3 - 100

DIELECTRIC PERFORMANCE CHARACTERISTICS

Capacitance Range	3.3pF to 6,800pF (25°C, 1.0 ±0.2 Vrms at 1kHz, for ≤ 1000pF use 1MHz)
Capacitance Tolerances	±0.25pF, ±0.50pF, ±1%, ±2%, ±5%, ±10%, ±20%
Dissipation Factor	0.1% Max (+25°C, 1.0 ±0.2 Vrms at 1kHz, for ≤ 1000pF use 1MHz)
Operating Temperature Range	-55°C to +125°C
Temperature Characteristics	COG: 0 ± 30 ppm/°C (-55°C to +125°C)
Voltage Ratings	600, 630, 1000, 1500, 2000, 2500, 3000, 4000, 5000, 7200VDC
Insulation Resistance	100K MΩ min. @ +25°C and 500VDC 10K MΩ min. @ +125°C and 500VDC
Dielectric Strength	Minimum 120% of rated WVDC

Hi-Q[®] High RF Power Ribbon Ledged MLC Capacitors



Microstrip Leads (Lead Style "M")

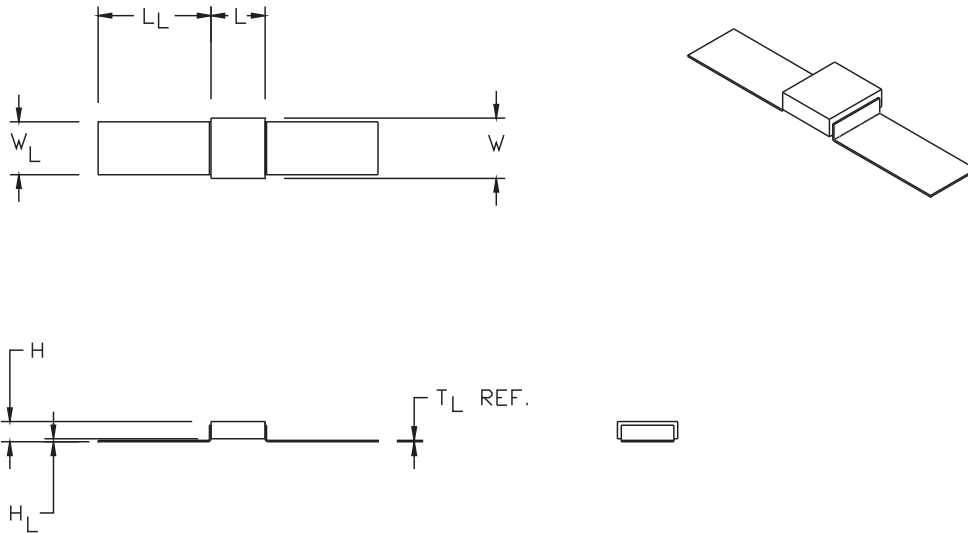

DIMENSIONS millimeters (inches)							
Unit Size	L ±0.51 (0.020)	L _L Min.	W ±0.64 (0.025)	W _L ±0.38 (0.015)	H ±0.64 (0.025)	H _L ±0.38 (0.015)	T _L Ref.
HQLC	5.72 (0.225)	12.7 (0.500)	6.35 (0.250)	6.10 (0.240)	3.68 (0.145)	0.64 (0.025)	0.10 (0.004)
HQLE	9.40 (0.370)	19.1 (0.750)	10.2 (0.400)	8.89 (0.350)	3.68 (0.145)	0.64 (0.025)	0.25 (0.010)

Note: Side to side lead alignment shall be within ±0.25 (0.010)

Axial Ribbon Leads (Lead Style "A")

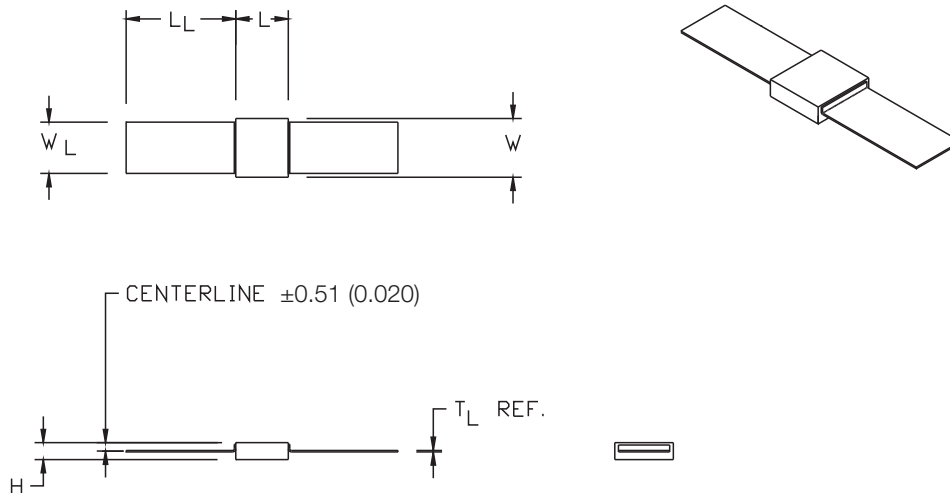

DIMENSIONS millimeters (inches)						
Unit Size	L ±0.51 (0.020)	L _L Min.	W ±0.64 (0.025)	W _L ±0.38 (0.015)	H ±0.64 (0.025)	T _L Ref.
HQLC	5.72 (0.225)	12.7 (0.500)	6.35 (0.250)	6.10 (0.240)	3.18 (0.125)	0.10 (0.004)
HQLE	9.40 (0.370)	19.1 (0.750)	10.2 (0.400)	8.89 (0.350)	3.18 (0.125)	0.25 (0.010)

Note: Side to side lead alignment shall be within ±0.25 (0.010)

Hi-Q[®] High RF Power MLC Capacitors



PERFORMANCE CHARACTERISTICS

Typical Series Resonant Frequency vs. Capacitance
HQCC and HQLC

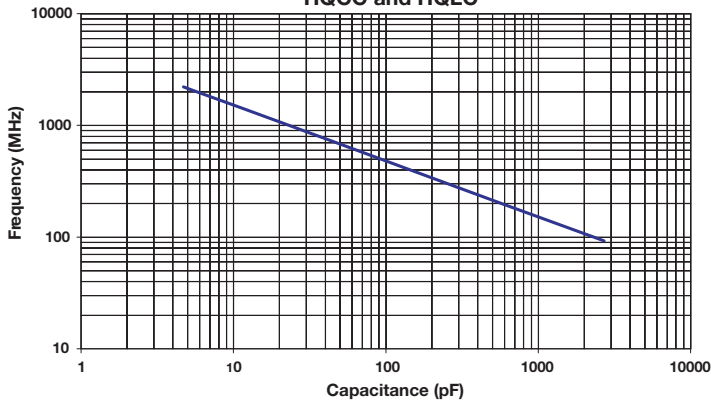

Typical ESR vs. Capacitance
HQCC and HQLC

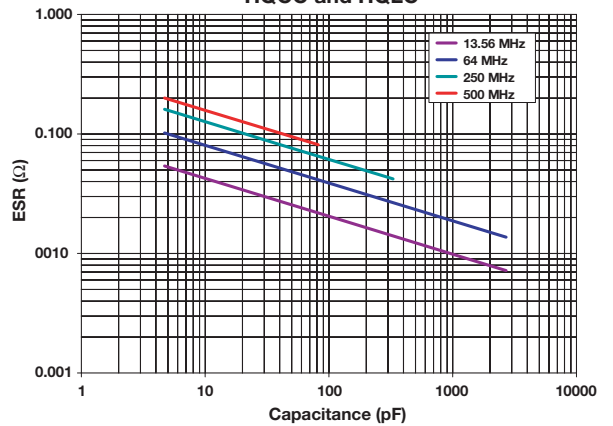

Typical Quality Factor vs. Capacitance
HQCC and HQLC

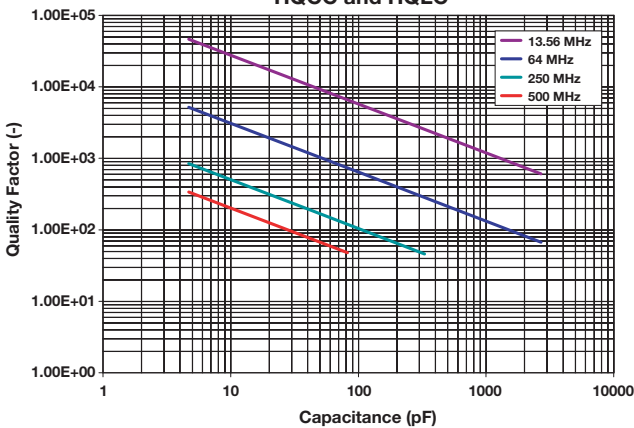

Maximum RMS Current vs. Capacitance
HQCC and HQLC

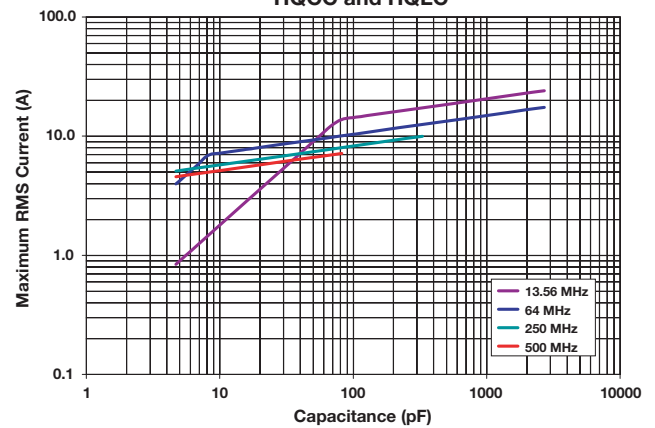

Hi-Q® High RF Power MLC Capacitors



PERFORMANCE CHARACTERISTICS

Typical Series Resonant Frequency vs. Capacitance
HQCE and HQLE

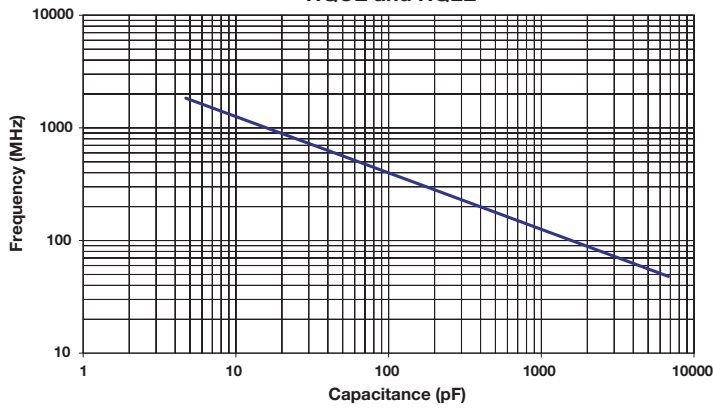

Typical ESR vs. Capacitance
HQCE and HQLE

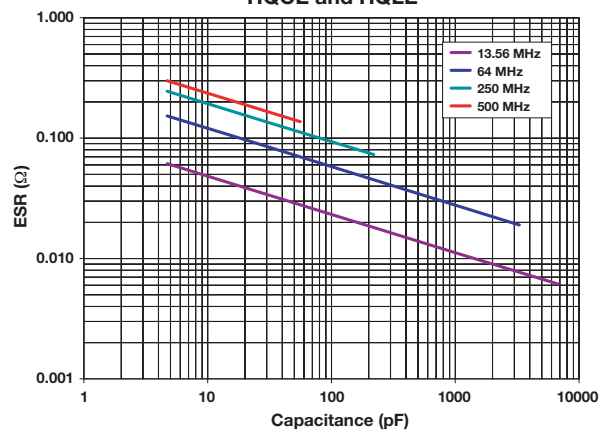

Typical Quality Factor vs. Capacitance
HQCE and HQLE

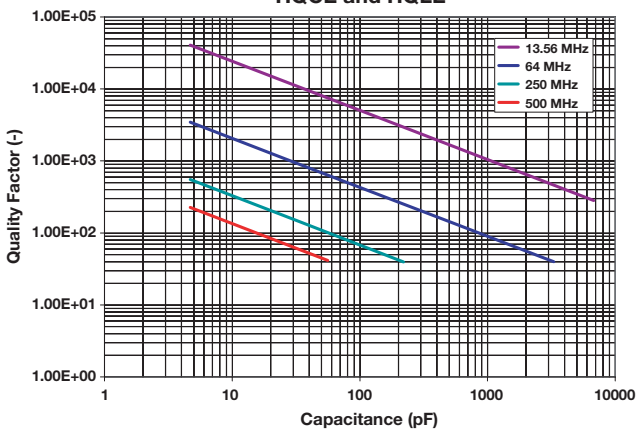

Maximum RMS Current vs. Capacitance
HQCE and HQLE

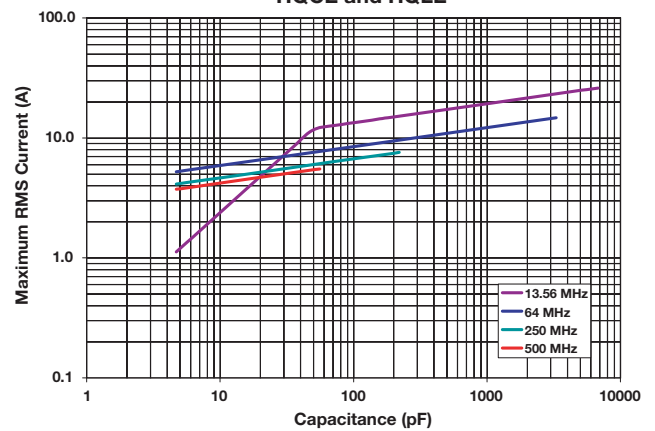

Tip & Ring

Multilayer Ceramic Chip Capacitors

AVX “Tip & Ring” or “ring detector” Multilayer Ceramic Chip Capacitors are designed as a standard telecom filter to block -48 Volts DC telephone line voltage and pass subscriber’s AC signal pulse (16 to 25Hz, 70 to 90Vrms). The typical ringing signal is seen on figure on page 106. The ringer capacitors replace large leaded film capacitors and are ideal for telecom/modem applications. Using AVX “Tip & Ring” capacitors not only saves valuable real estate on the board and reduces the weight of overall product, but also features standard surface mounting capabilities, so critical to new and compact designs.

The AVX “Tip & Ring” capacitors are offered in standard EIA sizes and standard values. They offer excellent high frequency performance, low ESR and improved temperature performance over film capacitors.

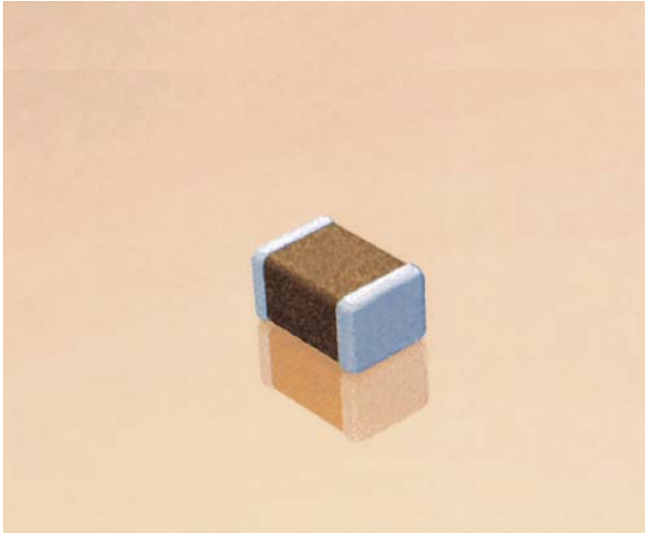

HOW TO ORDER

1812	P	C	104	K	A	T	1	A
AVX Style	Voltage	Temp Coefficient	Capacitance Code	Capacitance Tolerance	Test Level	Termination	Packaging	Special Code
0805 1206 1210 1808 1812 1825 2220 2225	250 VDC Telco Rating	X7R	(2 significant digits + no. of zeros) Examples: 1,000 pF = 102 22,000 pF = 223 220,000 pF = 224 1 μF = 105	K = ±10% M = ±20%	A = Standard	T = Plated Ni and Sn (RoHS Compliant) Z = FLEXITERM® 100% Tin (RoHS Compliant)	1 = 7" Reel 3 = 13" Reel 9 = Bulk	A = Standard

Contact factory for availability of Termination and Tolerance options for Specific Part Numbers.

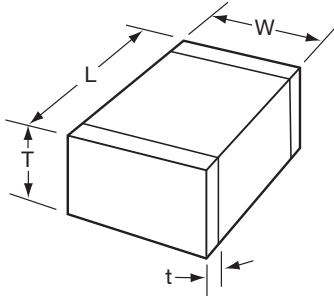

DIMENSIONS

millimeters (inches)

Style	0805	1206	1210*	1808*	1812*	1825*	2220*	2225*
(L) Length	2.01 ± 0.20 (0.079 ± 0.008)	3.20 ± 0.20 (0.126 ± 0.008)	3.2 ± 0.20 (0.126 ± 0.008)	4.57 ± 0.25 (0.180 ± 0.010)	4.50 ± 0.30 (0.177 ± 0.012)	4.50 ± 0.30 (0.177 ± 0.012)	5.60 ± 0.30 (0.220 ± 0.012)	5.60 ± 0.25 (0.220 ± 0.010)
(W)Width	1.25 ± 0.20 (0.049 ± 0.008)	1.60 ± 0.20 (0.063 ± 0.008)	2.50 ± 0.20 (0.098 ± 0.008)	2.03 ± 0.25 (0.080 ± 0.010)	3.2 ± 0.20 (0.126 ± 0.008)	6.34 ± 0.30 (0.252 ± 0.012)	5.10 ± 0.40 (0.200 ± 0.016)	6.35 ± 0.25 (0.250 ± 0.010)
(T) Thickness	1.30 max. (0.051 max.)	1.50 max. (0.059 max.)	1.78 max. (0.070 max.)	1.78 max. (0.070 max.)	2.00 max. (0.080 max.)	2.00max. (0.080 max.)	2.00 max. (0.080 max.)	2.00 max. (0.080 max.)
(t) terminal	0.50 ± 0.25 (0.020 ± 0.010)	0.50 ± 0.25 (0.020 ± 0.010)	0.50 ± 0.25 (0.020 ± 0.010)	0.63 ± 0.38 (0.025 ± 0.015)	0.63 ± 0.38 (0.025 ± 0.015)	0.63 ± 0.38 (0.025 ± 0.015)	0.63 ± 0.38 (0.025 ± 0.015)	0.63 ± 0.38 (0.025 ± 0.015)

*Reflow Soldering Only

Tip & Ring



Multilayer Ceramic Chip Capacitors

CAPACITANCE RANGE (μF)

Size	0805	1206	1210	1808	1812	1825	2220	2225
min.	0.0010	0.0010	0.0010	0.010	0.10	0.33	0.47	0.47
max.	0.027	0.082	0.22	0.27	0.47	1.0	1.0	1.2

“TIP & RING” GRAPH

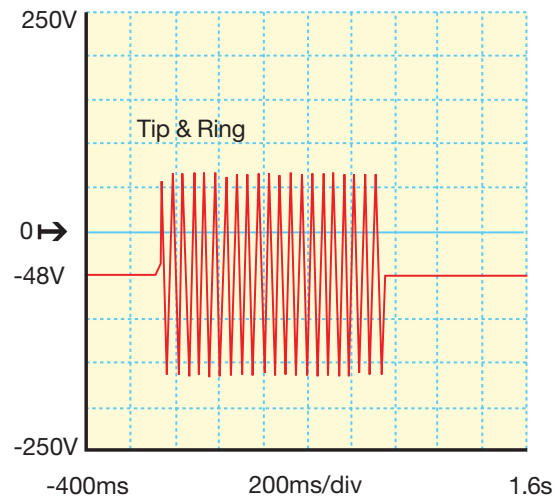

PERFORMANCE CHARACTERISTICS

Capacitance Range	1000 pF to 1.2 μF	(25°C, 1.0 \pm 0.2 Vrms at 1kHz)
Capacitance Tolerances	\pm 10%, \pm 20%	
Dissipation Factor	2.5% max.	(25°C, 1.0 \pm 0.2 Vrms at 1kHz)
Operating Temperature Range	-55°C to +125°C	
Temperature Characteristic	X7R \pm 15%	(0 VDC)
Voltage Rating	250 VDC	Telco rating
Insulation Resistance	1000 megohm-microfarad	min.
Dielectric Strength	Minimum 200% rated voltage for 5 seconds	at 50 mA max. current

Tip & Ring Tin/Lead Termination “B”



Multilayer Ceramic Chip Capacitors

AVX Corporation will support customers for commercial and military Multilayer Ceramic Capacitors with a termination consisting of 5% minimum lead. This termination is indicated by the use of a “B” in the 12th position of the AVX Catalog Part Number. This fulfills AVX’s commitment to providing a full range of products to our customers. AVX has provided in the following pages, a full range of values that we are offering in this “B” termination.

AVX “Tip & Ring” or “ring detector” Multilayer Ceramic Chip Capacitors are designed as a standard telecom filter to block -48 Volts DC telephone line voltage and pass subscriber’s AC signal pulse (16 to 25Hz, 70 to 90 VRMS). The typical ringing signal is seen on figure on page 108. The ringer capacitors replace large leaded film capacitors and are ideal for telecom/modem applications. Using AVX “Tip and Ring” capacitors not only saves valuable real estate on the board and reduces the weight of the overall product, but also features standard surface mounting capabilities, so critical to new and compact designs. The AVX “Tip & Ring” capacitors are offered in standard EIA sizes and standard values. They offer excellent high frequency performance, low ESR and improved temperature performance over film capacitors.

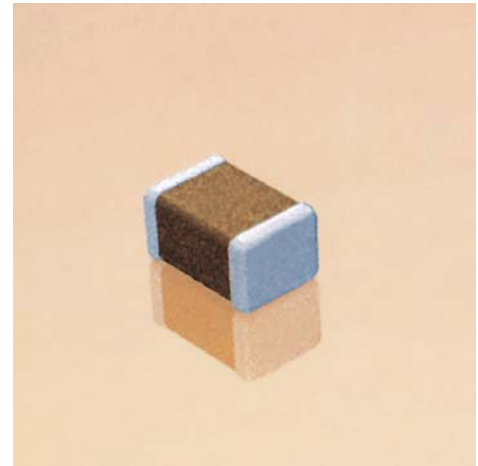

HOW TO ORDER

LD12	P	C	104	K	A	B	1	A
AVX Style	Voltage	Temperature Coefficient	Capacitance Code	Capacitance Tolerance	Test Level	Termination	Packaging	Special Code
LD05 - 0805 LD06 - 1206 LD10 - 1210 LD08 - 1808 LD12 - 1812 LD13 - 1825 LD20 - 2220 LD14 - 2225	250 VDC Telco Rating	X7R	(2 significant digits + no. of zeros) Examples: 1,000 pF = 102 22,000 pF = 223 220,000 pF = 224 1 μF = 105	K = ±10% M = ±20%	A = Standard	B = 5% Min Pb X = FLEXITERM® 5% min. Pb	1 = 7" Reel 3 = 13" Reel 9 = Bulk	A = Standard

Contact factory for availability of Termination and Tolerance options for Specific Part Numbers.

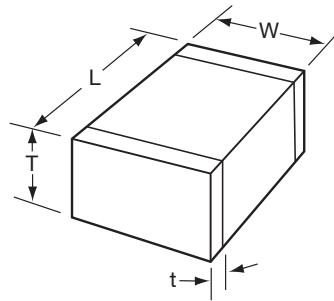

DIMENSIONS

millimeters (inches)

STYLE (SIZE)	LD05 (0805)	LD06 (1206)	LD10* (1210)	LD08* (1808)	LD12* (1812)	LD13* (1825)	LD20* (2220)	LD14* (2225)
(L) Length	2.01 ± 0.20 (0.079 ± 0.008)	3.20 ± 0.20 (0.126 ± 0.008)	3.2 ± 0.20 (0.126 ± 0.008)	4.57 ± 0.25 (0.180 ± 0.010)	4.50 ± 0.30 (0.177 ± 0.012)	4.50 ± 0.30 (0.177 ± 0.012)	5.60 ± 0.30 (0.220 ± 0.012)	5.60 ± 0.25 (0.220 ± 0.010)
(W) Width	1.25 ± 0.20 (0.049 ± 0.008)	1.60 ± 0.20 (0.063 ± 0.008)	2.50 ± 0.20 (0.098 ± 0.008)	2.03 ± 0.25 (0.080 ± 0.010)	3.2 ± 0.20 (0.126 ± 0.008)	6.34 ± 0.30 (0.252 ± 0.012)	5.10 ± 0.40 (0.200 ± 0.016)	6.35 ± 0.25 (0.250 ± 0.010)
(T) Thickness	1.30 max. (0.051 max.)	1.50 max. (0.059 max.)	1.78 max. (0.070 max.)	1.78 max. (0.070 max.)	2.00 max. (0.080 max.)	2.00 max. (0.080 max.)	2.00 max. (0.080 max.)	2.00 max. (0.080 max.)
(t) terminal	0.50 ± 0.25 (0.020 ± 0.010)	0.50 ± 0.25 (0.020 ± 0.010)	0.50 ± 0.25 (0.020 ± 0.010)	0.63 ± 0.38 (0.025 ± 0.015)	0.63 ± 0.38 (0.025 ± 0.015)	0.63 ± 0.38 (0.025 ± 0.015)	0.63 ± 0.38 (0.025 ± 0.015)	0.63 ± 0.38 (0.025 ± 0.015)

*Reflow Soldering Only



Tip & Ring Tin/Lead Termination “B”



Multilayer Ceramic Chip Capacitors

CAPACITANCE RANGE (μF)

STYLE (SIZE)	LD05 (0805)	LD06 (1206)	LD10 (1210)	LD08 (1808)	LD12 (1812)	LD13 (1825)	LD20 (2220)	LD14 (2225)
min.	0.0010	0.0010	0.0010	0.010	0.10	0.33	0.47	0.47
max.	0.027	0.082	0.22	0.27	0.47	1.0	1.0	1.2

“TIP & RING” GRAPH

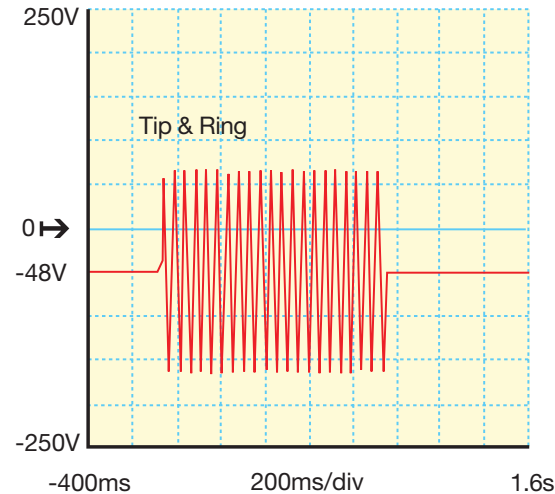

PERFORMANCE CHARACTERISTICS

Capacitance Range	1000 pF to 1.2 μF	(25°C, 1.0 \pm 0.2 Vrms at 1kHz)
Capacitance Tolerances	\pm 10%, \pm 20%	
Dissipation Factor	2.5% max. (25°C, 1.0 \pm 0.2 Vrms at 1kHz)	
Operating Temperature Range	-55°C to +125°C	
Temperature Characteristic	X7R \pm 15% (0 VDC)	
Voltage Rating	250 VDC Telco rating	
Insulation Resistance	1000 megohm-microfarad min.	
Dielectric Strength	Minimum 200% rated voltage for 5 seconds at 50 mA max. current	

AUTOMATIC INSERTION PACKAGING

TAPE & REEL QUANTITIES

All tape and reel specifications are in compliance with EIA481 or IEC-286-3.

Tape Size	8mm		12mm		24mm
Component Pitch P ₁	4.00		4.00	8.00	8.00
	0805 (LD05) 1206 (LD06) 1210 (LD10)	1808 (LD08)	1812 (LD12) 1825 (LD13) 2220 (LD20) 2225 (LD14)	HQCC	3640 (LD40) HQCE
Qty. per Reel/7" Reel	2000		2000	1000	500
Qty. per Reel/13" Reel	10,000		4000	4000	2000

Note: Lower quantity per reel may be used at the discretion of AVX.

REEL DIMENSIONS

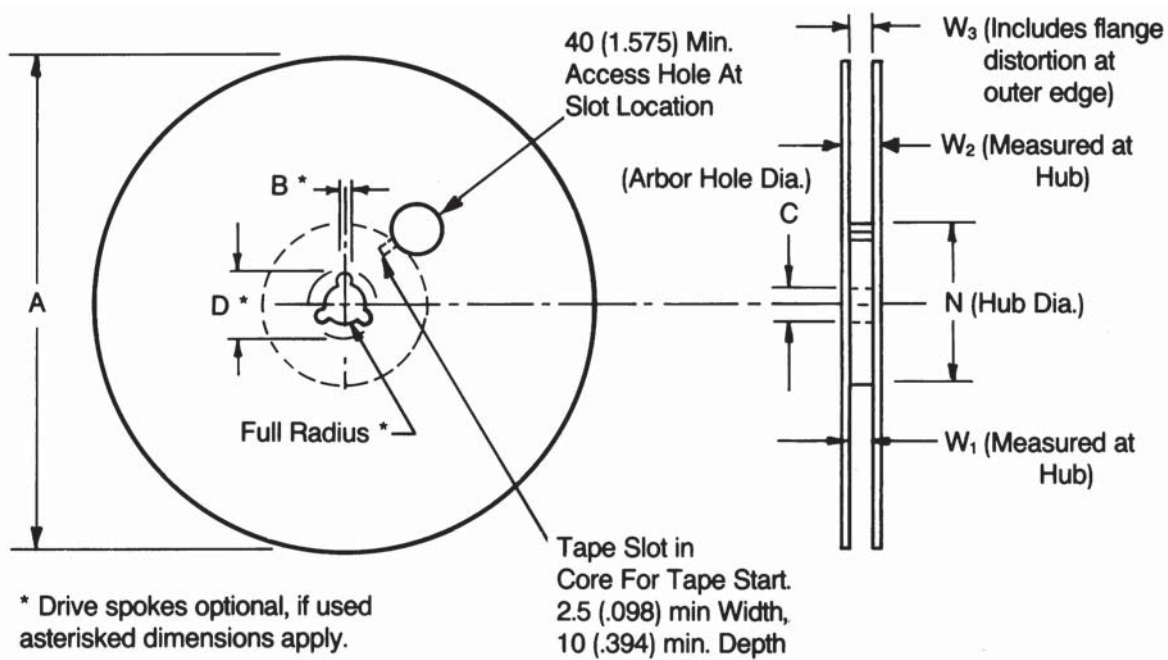

DIMENSIONS

millimeters (inches)

Tape Size	A Max.	B* Min.	C	D* Min.	N Min.	W ₁	W ₂ Max.	W ₃
8mm	330 (12.992)	1.5 (0.059)	13.0±0.20 (0.512±0.008)	20.2 (0.795)	50 (1.969)	8.4 ^{+1.5} _{-0.0} (0.331 ^{+0.059} _{-0.0})	14.4 (0.567)	7.9 Min. (0.311) 10.9 Max. (0.429)
12mm	330 (12.992)	1.5 (0.059)	13.0±0.20 (0.512±0.008)	20.2 (0.795)	50 (1.969)	12.4 ^{+2.0} _{-0.0} (0.488 ^{+0.079} _{-0.0})	18.4 (0.724)	11.9 Min. (0.469) 15.4 Max. (0.606)
24mm	360 (14.173)	1.5 (0.059)	13.0 ^{+0.5} _{-0.2} (0.512 ^{+0.020} _{-0.008})	20.2 (0.795)	60 (2.362)	24.4 ^{+2.0} _{-0.0} (0.961 ^{+0.079} _{-0.0})	30.4 (1.197)	23.9 Min. (0.941) 27.4 Max. (1.079)

Packaging of Chip Components

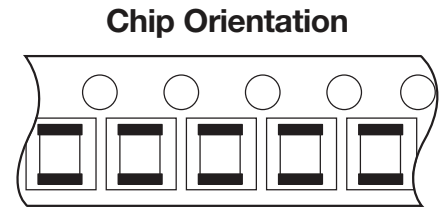
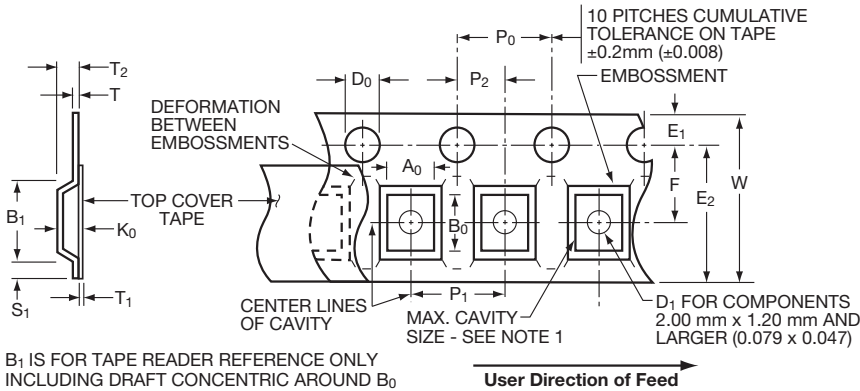

8mm, 12mm & 24mm Embossed Tape Metric Dimensions Will Govern

CONSTANT DIMENSIONS

millimeters (inches)

Tape Size	D ₀	E ₁	P ₀	S ₁ Min.	T Max.	T ₁
8mm	1.50 ^{+0.030} / _{-0.004}	1.75 ± 0.10	4.0 ± 0.10	0.60	0.60	0.10
12mm	(0.059 ^{+0.004} / _{-0.004})	(0.069 ± 0.004)	(0.157 ± 0.004)	(0.024)	(0.024)	(0.004)
24mm						Max.

VARIABLE DIMENSIONS

millimeters (inches)

Tape Size	B ₁ Max.	D ₁ Min.	E ₂ Min.	F	P ₁	P ₂	R Min. See Note 2	T ₂ Max.	W Max.	A ₀ B ₀ K ₀
8mm	4.35 (0.171)	1.00 (0.039)	6.25 (0.246)	3.50 ± 0.05 (0.138 ± 0.002)	4.00 ± 0.10 (0.157 ± 0.004)	2.00 ± 0.05 (0.079 ± 0.002)	25.0 (0.984)	2.50 (0.098)	8.30 (0.327)	See Note 1
12mm	8.20 (0.323)	1.50 (0.059)	10.25 (0.404)	5.50 ± 0.05 (0.217 ± 0.002)	4.00 ± 0.10 (0.157 ± 0.004)	2.00 ± 0.05 (0.079 ± 0.002)	30.0 (1.181)	6.50 (0.256)	12.3 (0.484)	See Note 1
12mm Double Pitch	8.20 (0.323)	1.50 (0.059)	10.25 (0.404)	5.50 ± 0.05 (0.217 ± 0.002)	8.00 ± 0.10 (0.315 ± 0.004)	2.00 ± 0.05 (0.079 ± 0.002)	30.0 (1.181)	6.50 (0.256)	12.3 (0.484)	See Note 1
24mm	20.10 (0.791)	1.50 (0.059)	22.25 (0.876)	11.5 ± 0.10 (0.453 ± 0.004)	16.00 ± 0.10 (0.630 ± 0.004)	2.00 ± 0.10 (0.079 ± 0.004)	30.0 (1.181)	12.00 (0.472)	24.3 (0.957)	See Note 1

NOTES:

- The cavity defined by A₀, B₀, and K₀ shall be configured to provide the following:
 - Surround the component with sufficient clearance such that:
 - the component does not protrude beyond the sealing plane of the cover tape.
 - the component can be removed from the cavity in a vertical direction without mechanical restriction, after the cover tape has been removed.
 - rotation of the component is limited to 20° maximum (see Sketches D & E).
 - lateral movement of the component is restricted to 0.5mm maximum (see Sketch F).
- Tape with or without components shall pass around radius "R" without damage.
- Bar code labeling (if required) shall be on the side of the reel opposite the round sprocket holes. Refer to EIA-556.
- B₁ dimension is a reference dimension for tape feeder clearance only.

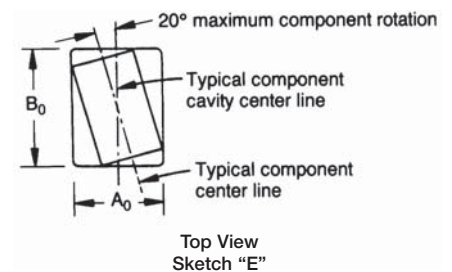
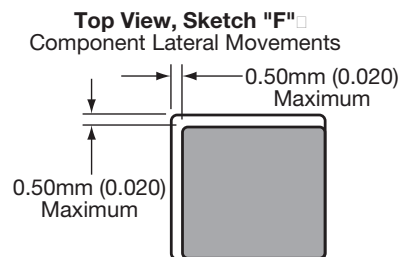
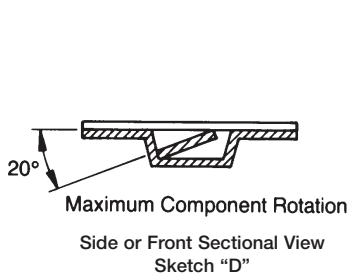

Single-In-Line Packages (SIP)



Capacitor Arrays

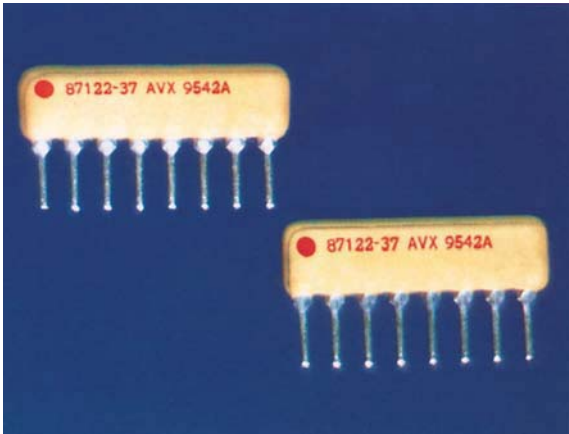

SIP-style, MLC ceramic capacitor arrays are Single-In-Line, conformally coated packages. These capacitor networks incorporate multiple capacitors into a single substrate and, therefore, offer excellent TC tracking. The utilization of SIP capacitor arrays minimizes board real estate and reduces component count in the assembly. Various circuit configurations and capacitance/voltage values are available.

Dimensions in millimeters (inches)

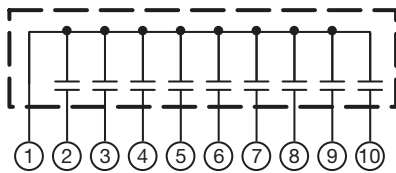
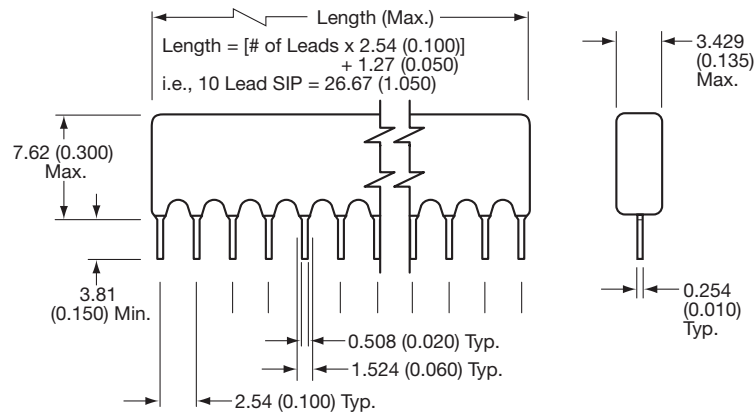

CIRCUIT CONFIGURATION "A"
ONE END LEAD GROUND

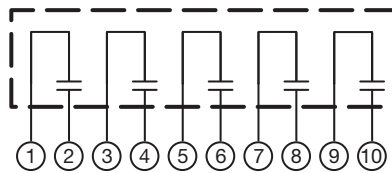

CIRCUIT CONFIGURATION "B"
ADJACENT LEAD PAIR CAPS

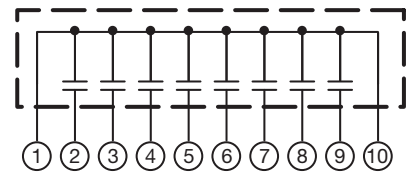

CIRCUIT CONFIGURATION "C"
BOTH END LEADS GROUND

Single-In-Line Packages (SIP)



Capacitor Arrays

HOW TO ORDER

SP	A	1	1	A	561	K	A	A
AVX Style	Circuit See Page 111 (A, B, C)	Lead Style	Voltage 50V = 5 100V = 1	Temperature Coefficient C0G = A X7R = C Z5U = E	Capacitance Code (2 significant digits + no. of zero) 10 pF = 100 100 pF = 101 1,000 pF = 102 22,000 pF = 223 220,000 pF = 224 1 μ F = 105 10 μ F = 106 100 μ F = 107	Capacitance Tolerance C0G: K = \pm 10% M = \pm 20% X7R: K = \pm 10% M = \pm 20% Z = +80%, -20% Z5U: M = \pm 20% Z = +80%, -20% P = GMV (+100, -0%)	Test Level A = Standard	Number of Leads 2 = 2 3 = 3 4 = 4 5 = 5 6 = 6 7 = 7 8 = 8 9 = 9 A = 10 B = 11 C = 12 D = 13 E = 14

*For dimensions, voltages, or capacitance values not specified, please contact factory.

Maximum Capacitance*		
	50V	100V
C0G	2200 pF	1500 pF
X7R	0.10 μ F	0.033 μ F
Z5U	0.39 μ F	0.10 μ F

AVX IS QUALIFIED TO THE FOLLOWING DSCC DRAWINGS

SPECIFICATION #	DESCRIPTION	CIRCUIT	LEADS	CAPACITANCE RANGE
87112	BX-100 VDC	A	8	1000 pF - 0.1 μ F
87116	C0G-100 VDC	A	8	10 pF - 820 pF
87119	BX-100 VDC	C	10	1000 pF - 0.1 μ F
87120	C0G-100 VDC	C	10	10 pF - 1000 pF
87122	BX-100 VDC	B	8	1000 pF - 0.1 μ F
88019	BX-100 VDC	A	10	1000 pF - 0.1 μ F
89086	C0G-100 VDC	B	8	10 pF - 820 pF

Discoidal MLC Feed-Through Capacitors and Filters



DC Style (US Preferred Sizes) / XB Style (European Preferred Sizes)
XF Style (Feed-Through Discoidal)

APPLICATION INFORMATION ON DISCOIDAL

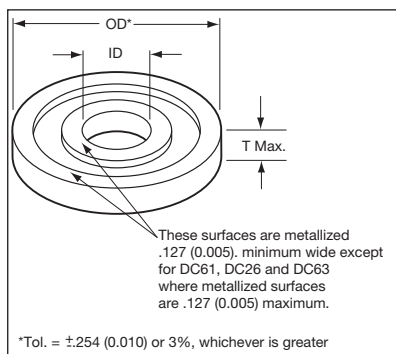
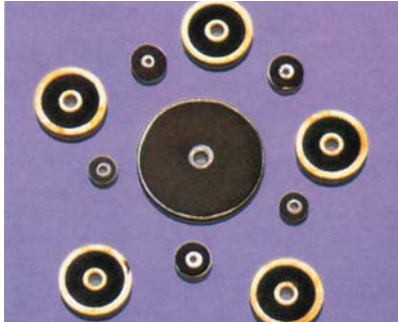

LOWEST CAPACITANCE IMPEDANCES TO GROUND

A discoidal MLC capacitor has very low impedance associated with its ground path since the signal is presented with a multi-directional path. These electrode paths, which can be as many as 100, allow for low ESR and ESL which are the major elements in impedance at high frequencies.

The assembled discoidal element or feed-thru allows signal to be fed in through a chassis or bulkhead, conditioned as it passes through the discoidal, and isolated by the chassis and discoidal from the original signal. An example of this application would be in an AFT circuit where the AC noise signal would be required to be stripped from the DC control signal. Other applications include single line EMI/RFI suppression, L-C filter construction, and coaxial shield bypass filtering.

The shape of the discoidal lends itself to filter construction. The short length allows compact construction where L-C construction is desired.

The size freedom associated with this element allows almost any inside/outside diameter combination. By allowing the inside diameter to equal the center insulator diameter of a coaxial signal line and special termination techniques, this device will allow bypass filtering of a floating shield to ground.

Discoidal capacitors are available in three temperature coefficients (C0G, X7R, Z5U) and a variety of sizes, the most standard of which appear in this catalog.

AVX's DC Series 50V, 100V, 200V, C0G and X7R parts are capable of meeting the requirements of MIL-PRF-31033.

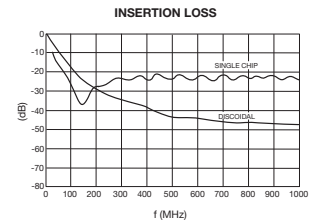

ELECTRICAL SPECIFICATIONS

Temperature Coefficient

C0G: A Temperature Coefficient - 0 ±30 ppm/°C, -55° +125°C

X7R: C Temperature Coefficient - ±15%, -55° to +125°C

Z5U: E Temperature Coefficient - +22, -56%, +10° to +85°C

Capacitance Test (MIL-STD-202 Method 305)

C0G: 25°C, 1.0±0.2 Vrms at 1KHz, for ≤100 pF use 1 MHz

X7R: 25°C, 1.0±0.2 Vrms at 1KHz

Z5U: 25°C, 0.5 Vrms max at 1KHz

Dissipation Factor 25°C

C0G: 0.15% Max @ 25°C, 1.0±0.2 Vrms at 1KHz, for ≤100 pF use 1 MHz

X7R: 2.5% Max @ 25°C, 1.0±0.2 Vrms at 1KHz

Z5U: 3.0% Max @ 25°C, 0.5 Vrms max at 1KHz

Insulation Resistance 25°C (MIL-STD-202 Method 302)

C0G and X7R: 100K MΩ or 1000 MΩ-μF, whichever is less.

Z5U: 10K MΩ or 1000 MΩ-μF, whichever is less.

Insulation Resistance 125°C (MIL-STD-202 Method 302)

C0G and X7R: 10K MΩ or 100 MΩ-μF, whichever is less.

Z5U: 1K MΩ or 100 MΩ-μF, whichever is less.

Dielectric Withstanding Voltage 25°C (Flash Test)*

C0G and X7R: 250% rated voltage for 5 seconds with 50 mA max

charging current. 500V rated units will be tested at 750 VDC

Z5U: 200% rated voltage for 5 seconds with 50 mA max charging current.

Life Test (1000 hrs)

C0G and X7R: 200% rated voltage at +125°C (500 Volt units

@ 600 VDC)

Z5U: 150% rated voltage at +85°C

Moisture Resistance (MIL-STD-202 Method 106)

C0G, X7R, Z5U: Ten cycles with no voltage applied.

Thermal Shock (MIL-STD-202 Method 107, Condition A)

Immersion Cycling (MIL-STD-202 Method 104, Condition B)

HOW TO ORDER

DC61	5	A	561	K	A	5	1	06
AVX Style	Voltage	Temperature Coefficient	Capacitance Code	Capacitance Tolerance	Test Level	Termination	Inside Diameter	Maximum Thickness
See Pages 114-116	50V = 5 100V = 1 200V = 2 500V = 7	C0G = A X7R = C Z5U = E	(2 significant digits + no. of zeros) Examples: 10 pF = 100 100 pF = 101 1,000 pF = 102 22,000 pF = 223 220,000 pF = 224 1 μF = 105	C0G: J = ±5% K = ±10% M = ±20% X7R: K = ±10% M = ±20% Z5U: M = ±20% Z = +80 -20% P = GMV	A = Standard	5 = Silver (AVX Standard)	See Pages 114-116	06 = 1.52 (0.060) 10 = 2.54 (0.100)

For dimensions, voltages or values not specified, please consult factory.



Discoidal MLC Feed-Through Capacitors and Filters



DC Style

SIZE AND CAPACITANCE SPECIFICATIONS

Dimensions: millimeters (inches)

EIA Characteristic		C0G																		
AVX Style	DC61	DC26	DC63	DC04	DC65	DC66	DC67	DC69	DC32	DC70	DC02	DC71	DC05	DC73	DC72					
Outside Diameter (OD)*	2.54 (0.100)	3.43 (0.135)	3.81 (0.150)	4.83 (0.190)	5.33 (0.210)	5.97 (0.235)	6.73 (0.265)	8.13 (0.320)	8.51 (0.335)	8.89 (0.350)	9.40 (0.370)	9.78 (0.385)	12.70 (0.500)	15.24 (0.600)	16.26 (0.640)					
Thickness Maximum (T)	1.52 (0.060)	1.52 (0.060)	1.52 (0.060)	2.54 (0.100)	2.54 (0.100)	2.54 (0.100)	2.54 (0.100)	2.54 (0.100)	2.54 (0.100)	2.54 (0.100)	2.54 (0.100)	2.54 (0.100)	2.54 (0.100)	2.54 (0.100)	2.54 (0.100)					
Inside Diameter No. (ID)	1,2	1,2,3	1,2,3,4	1,2,3	5,6,7 1,2,3,4	5,6,7 1,2,3,4	5,6,7 1,2,3,4	5,6,7 1,2,3,4	5,6,7 1,2,3,4	5,6,7 1,2,3,4	5,6,7 1,2,3,4	5,6,7 1,2,3,4	5,6,7 1,2,3,4	5,6,7 1,2,3,4	5,6,7 1,2,3,4					
Voltage	500 200 100 50	500 200 100 50	500 200 100 50	500 200 100 50	500 200 100 50	500 200 100 50	500 200 100 50	500 200 100 50	500 200 100 50	500 200 100 50	500 200 100 50	500 200 100 50	500 200 100 50	500 200 100 50	500 200 100 50					
cap. in pF	10 12 15	18 22 27	33 39 47	56 68 82	100 120 150	180 220 270	330 390 470	560 680 820	1000 1200 1500	1800 2200 2700	3300 3900 4700	5600 6800 8200	10,000 12,000 15,000	18,000 22,000 27,000	33,000 39,000 47,000	56,000 68,000 82,000	100,000 120,000 150,000	180,000 220,000 270,000	330,000 390,000 470,000	560,000 680,000

*Outside Diameter:
Tolerance is ±0.254 (0.010) or 3%
whichever is greater

Inside Diameter:		
1 = .635 ^{+0.127} _{-.051} (.025 ^{+0.005} _{-.002})	3 = .914 ^{+0.127} _{-.051} (.036 ^{+0.005} _{-.002})	5 = 1.27±.127 (0.050±.005)
2 = .762 ^{+0.127} _{-.051} (.030 ^{+0.005} _{-.002})	4 = 1.07 ^{+0.127} _{-.051} (.042 ^{+0.005} _{-.002})	6 = 1.52±.127 (0.060±.005)
		7 = 1.73±.127 (0.068±.005)



Discoidal MLC Feed-Through Capacitors and Filters



DC Style

SIZE AND CAPACITANCE SPECIFICATIONS

Dimensions: millimeters (inches)

EIA Characteristic	X7R															
AVX Style	DC61	DC26	DC63	DC04	DC65	DC66	DC67	DC69	DC32	DC70	DC02	DC71	DC05	DC73	DC72	
Outside Diameter (OD)*	2.54 (0.100)	3.43 (0.135)	3.81 (0.150)	4.83 (0.190)	5.33 (0.210)	5.97 (0.235)	6.73 (0.265)	8.13 (0.320)	8.51 (0.335)	8.89 (0.350)	9.40 (0.370)	9.78 (0.385)	12.70 (0.500)	15.24 (0.600)	16.26 (0.640)	
Thickness Maximum (T)	1.52 (0.060)	1.52 (0.060)	1.52 (0.060)	2.54 (0.100)	2.54 (0.100)	2.54 (0.100)	2.54 (0.100)	2.54 (0.100)	2.54 (0.100)	2.54 (0.100)	2.54 (0.100)	2.54 (0.100)	2.54 (0.100)	2.54 (0.100)	2.54 (0.100)	
Inside Diameter No. (ID)	1,2	1,2,3	1,2,3,4	1,2,3	5,6,7 1,2,3,4	5,6,7 1,2,3,4	5,6,7 1,2,3,4	5,6,7 1,2,3,4	5,6,7 1,2,3,4	5,6,7 1,2,3,4	5,6,7 1,2,3,4	5,6,7 1,2,3,4	5,6,7 1,2,3,4	5,6,7 1,2,3,4	5,6,7 1,2,3,4	
Voltage	500 200 100 50	500 200 100 50	500 200 100 50	500 200 100 50	500 200 100 50	500 200 100 50	500 200 100 50	500 200 100 50	500 200 100 50	500 200 100 50	500 200 100 50	500 200 100 50	500 200 100 50	500 200 100 50	500 200 100 50	
cap. in pF	56	68	82													
	100	120	150													
	180	220	270													
	330	390	470													
	560	680	820													
	1000	1200	1500													
	1800	2200	2700													
	3300	3900	4700													
	5600	6800	8200													
	10,000	12,000	15,000													
	18,000	22,000	27,000													
	33,000	39,000	47,000													
	56,000	68,000	82,000													
	100,000	120,000	150,000													
	180,000	220,000	270,000													
	330,000	390,000	470,000													
	560,000	680,000	820,000													
	1.0 μF	1.2 μF	1.5 μF													
	1.8 μF	2.2 μF	2.7 μF													
	3.3 μF	3.9 μF	6.8 μF													

*Outside Diameter:
Tolerance is ±0.254 (0.010) or 3%
whichever is greater

*Outside Diameter:			Tolerance is ±0.254 (0.010) or 3% whichever is greater			Inside Diameter:			5 = 1.27±.127 (0.050±.005)		
1 = .635	+ .127	(.025 +.005)	3 = .914	+ .127	(.036 +.005)	5 = 1.27±.127	(0.050±.005)	6 = 1.52±.127	(0.060±.005)	7 = 1.73±.127	(0.068±.005)
	- .051	(-.002)		- .051	(-.002)						
2 = .762	+ .127	(.030 +.005)	4 = 1.07	+ .127	(.042 +.005)						
	- .051	(-.002)		- .051	(-.002)						



Discoidal MLC Feed-Through Capacitors and Filters



DC Style

SIZE AND CAPACITANCE SPECIFICATIONS

Dimensions: millimeters (inches)

EIA Characteristic		Z5U														
AVX Style	DC61	DC26	DC63	DC04	DC65	DC66	DC67	DC69	DC32	DC70	DC02	DC71	DC05	DC73	DC72	
Outside Diameter (OD)*	2.54 (0.100)	3.43 (0.135)	3.81 (0.150)	4.83 (0.190)	5.33 (0.210)	5.97 (0.235)	6.73 (0.265)	8.13 (0.320)	8.51 (0.335)	8.89 (0.350)	9.40 (0.370)	9.78 (0.385)	12.70 (0.500)	15.24 (0.600)	16.26 (0.640)	
Thickness Maximum (T)	1.52 (0.060)	1.52 (0.060)	1.52 (0.060)	2.54 (0.100)	2.54 (0.100)	2.54 (0.100)	2.54 (0.100)	2.54 (0.100)	2.54 (0.100)	2.54 (0.100)	2.54 (0.100)	2.54 (0.100)	2.54 (0.100)	2.54 (0.100)	2.54 (0.100)	
Inside Diameter No. (ID)	1,2	1,2,3	1,2,3,4	1,2,3	5,6,7 1,2,3,4	5,6,7 1,2,3,4	5,6,7 1,2,3,4	5,6,7 1,2,3,4	5,6,7 1,2,3,4	5,6,7 1,2,3,4	5,6,7 1,2,3,4	5,6,7 1,2,3,4	5,6,7 1,2,3,4	5,6,7 1,2,3,4	5,6,7 1,2,3,4	
Voltage	200 100 50	200 100 50	200 100 50	200 100 50	200 100 50	200 100 50	200 100 50	200 100 50	200 100 50	200 100 50	200 100 50	200 100 50	200 100 50	200 100 50	200 100 50	
cap. in pF	1800 2200 2700															
	3300 3900 4700															
	5600 6800 8200															
	10,000 12,000 15,000															
	18,000 22,000 27,000															
	33,000 39,000 47,000															
	56,000 68,000 82,000															
	100,000 120,000 150,000															
	180,000 220,000 270,000															
	330,000 390,000 470,000															
	560,000 680,000 820,000															
	1.0 µF 1.2 µF 1.5 µF															
	1.8 µF 2.2 µF 2.7 µF															
	3.3 µF 3.9 µF 4.7 µF															
	5.6 µF 6.8 µF 8.2 µF															
	10.0 µF 12.0 µF 15.0 µF															

*Outside Diameter:
Tolerance is ±0.254 (0.010) or 3%
whichever is greater

Inside Diameter:		
1 = .635 ^{+.127} _{-.051} (.025 ^{+.005} _{-.002})	3 = .914 ^{+.127} _{-.051} (.036 ^{+.005} _{-.002})	5 = 1.27±.127 (0.050±.005)
2 = .762 ^{+.127} _{-.051} (.030 ^{+.005} _{-.002})	4 = 1.07 ^{+.127} _{-.051} (.042 ^{+.005} _{-.002})	6 = 1.52±.127 (0.060±.005)
		7 = 1.73±.127 (0.068±.005)



Discoidal MLC Feed-Through Capacitors and Filters



Discoidal XB / Feed-through XF – C0G

HOW TO ORDER

XB	06	Z	G	0104	K	--
AVX Style XB XF	Size 03 04 06 07 08 09 10 14 15	Class C = NPO Z = X7R	Voltage D = 63 E = 100 F = 160 G = 250 I = 400 J = 500 (optional)	Capacitance EIA code on 3 or 4 digits	Tolerance J = 5% K = 10% M = 20%	Packaging -- : bulk

REFERENCES

Type	Terminations	Reference	Mechanical Characteristics
	Silver palladium	XB..C•....• --	CECC 30600 MIL 11015 D Conformance to CK12 TYPE
	Tinned silver palladium	XB..C•....• MB	
	Silver palladium	XF.C•....• --	
	Tinned silver palladium	XF.C•....• MB	

DIMENSIONS

millimeters (inches)

Size	OD		ID		bm min	Ø (XF)	e	
	XB/XF	XB/XF..MB	XB	XB..MB			min	max
03	3.8 ± 0.3 (0.150 ± 0.012)	4.1 ± 0.4 (0.161 ± 0.016)	0.7 ± 0.15 (0.028 ± 0.006)	> 0.4 (> 0.016)	0.1 (0.004)	0.5 (0.020)	1	See table
04	3.8 ± 0.3 (0.150 ± 0.012)	—	1.2 ± 0.15 (0.047 ± 0.006)	—	0.1 (0.004)	—	1	on page
08	7.9 ± 0.3 (0.311 ± 0.012)	8.2 ± 0.4 (0.323 ± 0.016)	0.8 ± 0.15 (0.031 ± 0.006)	> 0.5 (> 0.020)	0.2 (0.008)	0.6 (0.024)	1	118

ELECTRICAL CHARACTERISTICS

Dielectric Class	C0G
Temperature Coefficient	0 ± 30 ppm/°C
Climatic Category	-55 / 125 / 56
Operating Temperature	-55 +125°C
Rated Voltage (U _R)	50 to 400V
Test Voltage (U _e)	2.5 U _R
Tangent of Loss Angle C < 50 pF	tg δ < 1.5 (150/C _R + 7)10 ⁻⁴
C ≥ 50 pF	tg δ < 15(10 ⁻⁴)
Insulation Resistance	Ri ≥ 100 GΩ



Discoidal MLC Feed-Through Capacitors and Filters



Discoidal XB / Feed-through XF – C0G

RATED VOLTAGE – RATED CAPACITANCES

Capacitance C_R	Size		
	03	04	08
	Rated Voltage - U_R (V)/Ur code		
	50/63	50/63	160
	D	D	F
10 pF			
15 pF			
22 pF			
33 pF			
47 pF			
68 pF			
100 pF			
150 pF			
220 pF			
330 pF			
470 pF			
680 pF			
1000 pF			
1500 pF			
2200 pF			
3300 pF			
4700 pF			
6800 pF			
10 nF			
15 nF			
22 nF			
33 nF			
47 nF			
68 nF			
100 nF			
Thickness e_{max} mm (inches)	1.4 (0.055)	1.4 (0.055)	1.8 (0.071)

- other values, please contact us
- for tinned types, add 0.5 (0.020) to e_{max}

Discoidal MLC Feed-Through Capacitors and Filters



Discoidal XB / Feed-through XF – X7R

REFERENCES

Type	Terminations	Reference	Mechanical Characteristics
	Silver palladium	XB..Z•.... --	CECC 30700 MIL 11015 D Conformance to CK12, CK13, CK14 TYPES
	Tinned silver palladium	XB..Z•....• MB	
	Silver palladium	XF..Z•.... --	
	Tinned silver palladium	XF..Z•....• MB	

DIMENSIONS

millimeters (inches)

Size	OD		XB ID	XB...MB	bm min	Ø (XF)	e	
	XB/XF	XB/XF...MB					min	max
03	3.8 ± 0.3 (0.150 ± 0.012)	4.1 ± 0.4 (0.161 ± 0.016)	0.7 ± 0.15 (0.028 ± 0.006)	> 0.4 (> 0.016)	0.1 (0.004)	0.5 (0.020)	1.0 (0.039)	See table on page 120
04	3.8 ± 0.3 (0.150 ± 0.012)	—	1.2 ± 0.15 (0.047 ± 0.006)	—	0.1 (0.004)	—	1.0 (0.039)	
06	6.4 ± 0.3 (0.252 ± 0.012)	6.7 ± 0.4 (0.264 ± 0.016)	1.7 ± 0.15 (0.067 ± 0.006)	> 0.5 (> 0.020)	0.2 (0.008)	0.6 (0.024)	1.0 (0.039)	
07	7.3 ± 0.3 (0.287 ± 0.012)	7.6 ± 0.4 (0.299 ± 0.016)	1.7 ± 0.15 (0.067 ± 0.006)	> 0.5 (> 0.020)	0.2 (0.008)	0.6 (0.024)	1.0 (0.039)	
08	7.9 ± 0.3 (0.311 ± 0.012)	8.2 ± 0.4 (0.323 ± 0.016)	0.8 ± 0.15 (0.031 ± 0.006)	> 0.5 (> 0.020)	0.2 (0.008)	0.6 (0.024)	1.0 (0.039)	
09	8.4 ± 0.4 (0.331 ± 0.016)	8.7 ± 0.5 (0.343 ± 0.020)	1.6 ± 0.3 (0.063 ± 0.012)	> 0.5 (> 0.020)	0.2 (0.008)	0.6 (0.024)	1.0 (0.039)	
10	9.6 ± 0.4 (0.378 ± 0.016)	9.9 ± 0.5 (0.390 ± 0.020)	1.2 ± 0.15 (0.047 ± 0.006)	> 0.9 (> 0.035)	0.2 (0.008)	1.0 (0.039)	1.0 (0.039)	
14	14.0 ± 0.5 (0.551 ± 0.020)	14.3 ± 0.6 (0.563 ± 0.024)	1.7 ± 0.3 (0.067 ± 0.012)	> 0.9 (> 0.035)	0.2 (0.008)	1.0 (0.039)	1.0 (0.039)	
15	15.0 ± 0.5 (0.591 ± 0.020)	15.3 ± 0.6 (0.602 ± 0.024)	2.3 ± 0.3 (0.091 ± 0.012)	> 0.9 (> 0.035)	0.2 (0.008)	1.0 (0.039)	1.0 (0.039)	

ELECTRICAL CHARACTERISTICS

Dielectric Class	X7R
Temperature Coefficient	$\Delta C/C \leq \pm 15\%$ (-55 +125°C)
Climatic Category	-55 / 125 / 56
Operating Temperature	-55 +125°C
Rated Voltage (U_R)	50 to 400V
Test Voltage (U_e)	2.5 U_R
Tangent of Loss Angle	$\text{tg } \delta \leq 250(10^{-4})$
Insulation Resistance	
C ≤ 10 nF	$R_i \geq 100 \text{ G}\Omega$
C > 10 nF	$R_i \times C \geq 1000\text{s}$

Discoidal MLC Feed-Through Capacitors and Filters



Discoidal XB / Feed-through XF – X7R

RATED VOLTAGE – RATED CAPACITANCES

Capacitance C_R	Size																									
	03-04		06			07					08-09					10					14-15					
	U _R - (V)/Code U _R																									
	50/63	50/63	100	160	250	50/63	100	160	250	400	50/63	100	160	250	400	50/63	100	160	250	400	50/63	100	160	250	400	
D	D	E	F	G	D	E	F	G	I	D	E	F	G	I	D	E	F	G	I	D	E	F	G	I		
100 pF																										
150 pF																										
220 pF																										
330 pF																										
470 pF																										
680 pF																										
1000 pF																										
1500 pF																										
2200 pF																										
3300 pF																										
4700 pF																										
6800 pF																										
10 nF																										
15 nF																										
22 nF																										
33 nF																										
47 nF																										
68 nF																										
100 nF																										
150 nF																										
220 nF																										
330 nF																										
470 nF																										
680 nF																										
1 μF																										
1.5 μF																										
2.2 μF																										
3.3 μF																										
4.7 μF																										
e _{max} mm (inches)	1.4 (0.055)	2 (0.079)	2 (0.079)	2 (0.079)	2 (0.079)	3 (0.118)	3 (0.118)	3 (0.118)	3 (0.118)	3 (0.118)	1.8 (0.071)	3 (0.118)	1.8 (0.071)	3 (0.118)	3 (0.118)	3 (0.118)	3 (0.118)	3 (0.118)	3 (0.118)	3 (0.118)	3 (0.118)	3 (0.118)	3 (0.118)	3 (0.118)	3 (0.118)	3 (0.118)

- other values, please contact us
- for tinned types, add 0.5 (0.020) to e_{max}



Filtered Arrays

XD... Type



FEATURES

- To be used beneath a connector
- Provide an EMI filtered signal line between electronic modules
- Effective insertion loss from 1MHz up to ~ 1GHz
- Surface mount compatible

HOW TO ORDER

XD	06	Z	F	0153	K	--
AVX Style XD	Size 03 06 07	Class C = NPO Z = X7R	Voltage F = 200 J = 500	Capacitance EIA code on 3 or 4 digits	Tolerance NPO F = ±1% G = ±2% J = ±5% K = ±10% X7R J = ±5% K = ±10% M = ±20%	Packaging SUFFIX Burn-in 100% 168H = T5 Burn-in 100% 48H = T3 No burn-in = --

STYLE & DIMENSIONS

		millimeters (inches)						
		TYPES	L	P	D	d	bm maxi	Thickness maxi
XD07 (4 capacitors)			7.00 ± 0.15 (0.275 ± 0.006)	2.54 (0.100)	1.70 ± 0.15 (0.067 ± 0.006)	1.00 ± 0.10 (0.039 ± 0.0039)	0.3	2mm
XD06 (4 capacitors)			6.00 ± 0.15 (0.236 ± 0.006)	2.54 (0.100)	1.70 ± 0.15 (0.067 ± 0.006)	1.00 ± 0.10 (0.039 ± 0.0039)	0.3	2mm
XD03 (2 capacitors)			6.00 x 3.00 ± 0.15 (0.236 x 0.118 ± 0.006)	2.54 (0.100)	1.70 ± 0.15 (0.067 ± 0.006)	1.0 ± 0.10 (0.039 ± 0.0039)	0.3	1.5mm

Terminations: Silver – Palladium – Platinum, on 4 or only 2 sides of the array

CAPACITANCE vs VOLTAGE TABLE

Cap. Range (each cap.)	X7R		NPO	
	200VDC	500VDC	200VDC	500VDC
XD07...	33nF → 120nF	4.7nF → 18nF	470pF → 1500pF	220pF → 620pF
XD06...	15nF → 68nF	2.2nF → 10nF	220pF → 750pF	120pF → 330pF
XD03...	8.2nF → 39nF	1nF → 4.7nF	180pF → 390pF	82pF → 180pF

ELECTRICAL CHARACTERISTICS

Dielectric Class	X7R	NPO
Temperature Coefficient	$\Delta C/C \leq \pm 15\%$ (-55 +125°C)	0 ± 30ppm/°C
Climatic Category	55 / 125 / 56	55 / 125 / 56
Rated Voltage (U_R)	200 VDC	500VDC
Test Voltage (U_e)	2 x U_R	1.5 x U_R
Tangent of Loss Angle - DF	$\text{tg } \delta \leq 250(10^{-4})$	$\text{tg } \delta \leq 15(10^{-4})$
Insulation Resistance	$C \leq 10\text{nF} = R_i \geq 100 \text{ G}\Omega$ $C > 10\text{nF} = R_i \times C \geq 1000\text{s}$	$R_i \geq 100 \text{ G}\Omega$

A Dedicated Facility / BS9100 Requirements

Baseline Products – A Selection of Options

As a matter of course, AVX maintains a level of quality control that is sufficient to guarantee whatever reliability specifications are needed. However, AVX goes further. There are over 65 quality control and inspection operations that are available as options to a customer. Any number may be requested and written into a baseline process. The abbreviated list that follows indicates the breadth and thoroughness of available Q.C. services at AVX:

- Ultrasonic Scanning
- Destructive Physical Analysis (DPA)
- X-Ray
- Bondability Testing
- Sorting and Matching to Specification Limits
- Temperature and Immersion Cycling
- Load/Humidity Life Testing
- Dye Penetration Evaluation
- 100% Ceramic Sheet Inspection
- Voltage Conditioning
- Termination Pull Testing
- Pre-encapsulation Inspection

Within the “specials” area, AVX accommodates a broad variety of customer needs. The AVX facilities are capable of developing and producing the most reliable and advanced MLCs available anywhere in the world today. Yet it is equally adept at making volume “custom” components that may differ only in

markings or lead placement from the standard catalog part.

Stretching the Limits

Advanced Products are developed to meet the extraordinary needs of specific applications. Requirements may include: low ESR, low ESL, voltages up to 10's of thousands, advanced decoupling designs for frequencies up to 10's of megahertz, temperatures up to 200°C, extremely high current discharge, ability to perform in high radiation or toxic atmospheres, or minimizing piezoelectric effect in high vibration environments.

In addition, solving customer packaging problems, aside from addressing circuit problems, is available. Special lead frames for high current or special mounting requirements are examples. Multiple ceramic chip package designs per customer requirements are also available.

Advanced Products always begin with a joint development program involving AVX and the customer. In undersea cable components, for example, capacitance and impedance ratings had to be maintained within 1% over the multi-year life of the system. In this case, Advanced Products not only met the parametric requirements of the customer, but accelerated life testing of 3,500 units indicated an average life expectancy of over 100,000 years.

Baseline Program Management

Baseline Program Management has been AVX's forte over the years. This is both a product and a service function designed to provide the customer the full capabilities of AVX in meeting their program requirements. AVX has had Baseline and Program Management in the following major systems:

- AT&T Undersea Cable
- Minuteman
- Peacekeeper
- STC Undersea Cable
- CIT Undersea Cable
- Raytheon-Hawk Missile
- Trident
- Small Missile Program
- Northrop - Peacekeeper
- Sparrow Program
- Space Station
- European Space Agency (ESA)
- Commercial Satellite Program
- Arianne 4 & 5
- EuroFighter (Typhoon)
- EH101 (Merlin)

AVX technical personnel stand ready to answer any questions and provide any information required on your programs from the most exotic Hi-Rel part to the simplest variation on a standard. Put the experience, technology and facilities of the leading company in multilayer ceramics to work for you. No other source offers the unique combination of capability and commitment to advanced application specific components.

PROCUREMENT OF COMPONENTS OF BS9100 (CH/CV RANGE 50-500V)

The manufacturing facilities have ISO9001 approval. Customers requiring BS9100 approved components are requested to follow these steps:

1. The customer shall submit a specification for the required components to AVX for approval. Once agreed a Customer Detail Specification (CDS) number will be allocated by AVX to this specification. This number with its current revision must be quoted at the time of order placement.
2. If the customer has no specification, then AVX will supply a copy of the standard CDS for the customer's approval and signature. As in 1 above, when agreed this CDS number must be quoted at order entry. In the event of agreement not being reached the component cannot be supplied to BS9100.

For assistance contact: EMAP Specification Engineering
Dept. AVX Ltd. Coleraine, Northern Ireland
Telephone ++44 (0)28703 44188, Fax ++44 (0)28703 55527

PACKAGING

Unless otherwise stated in the appropriate data sheet parts are supplied in a waffle pack.

Advanced Application Specific Products



Examples of Special Packaging and Custom Lead Configurations from Advanced Products

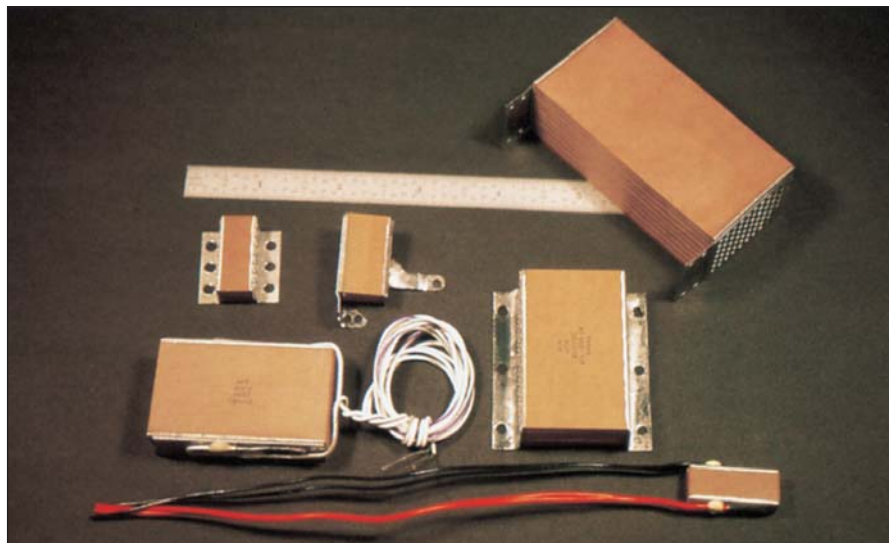

Custom Lead Configurations. . .

optimum 3D packaging, high current applications and high reliability stress relief mounting.

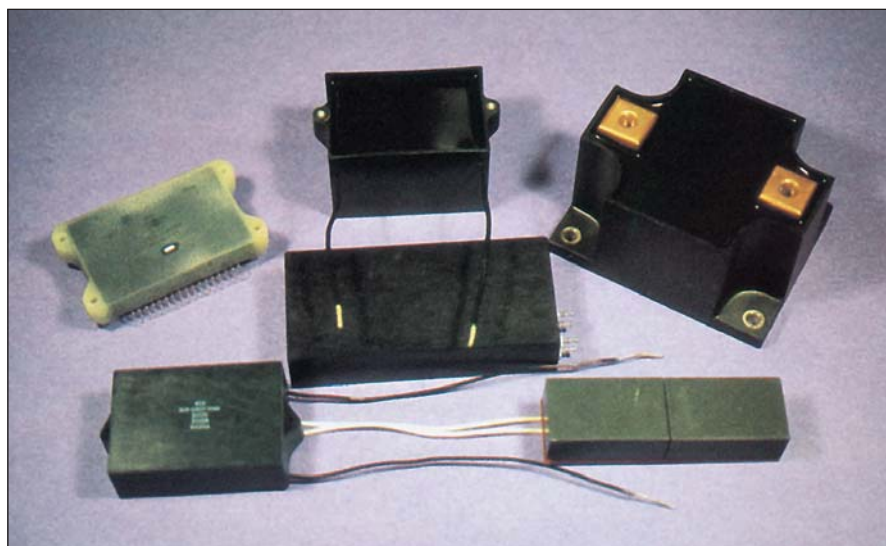

Custom Packaging. . .

eliminate reliability concerns with multiple component assembly.

Many other innovations are available from Advanced Products. Let them apply these ideas to your application specific programs.



AMERICAS

AVX Myrtle Beach, SC
Tel: 843-448-9411

AVX Northwest, WA
Tel: 360-699-8746

AVX Midwest, IN
Tel: 317-861-9184

AVX Mid/Pacific, CA
Tel: 408-988-4900

AVX Northeast, MA
Tel: 617-479-0345

AVX Southwest, CA
Tel: 949-859-9509

AVX Canada
Tel: 905-238-3151

AVX South America
Tel: +55-11-4688-1960

EUROPE

AVX Limited, England
Tel: +44-1252-770000

AVX S.A.S., France
Tel: +33-1-69-18-46-00

AVX GmbH, Germany
Tel: +49-8131-9004-0

AVX SRL, Italy
Tel: +39-02-614-571

AVX Czech Republic
Tel: +420-57-57-57-521

AVX/ELCO UK
Tel: +44-1638-675000

ELCO Europe GmbH
Tel: +49-2741-299-0

AVX S.A., Spain
Tel: +34-91-63-97-197

AVX Benelux
Tel: +31-187-489-337

ASIA-PACIFIC

**AVX/Kyocera (S) Pte Ltd.,
Singapore**
Tel: +65-6286-7555

**AVX/Kyocera, Asia, Ltd.,
Hong Kong**
Tel: +852-2363-3303

**AVX/Kyocera Yuhan Hoesa,
South Korea**
Tel: +82-2785-6504

**AVX/Kyocera HK Ltd.,
Taiwan**
Tel: +886-2-2656-0258

**AVX/Kyocera (M) Sdn Bhd,
Malaysia**
Tel: +60-4228-1190

**AVX/Kyocera International
Trading Co. Ltd.,
Shanghai**
Tel: +86-21-3255 1933

**AVX/Kyocera Asia Ltd.,
Shenzen**
Tel: +86-755-3336-0615

**AVX/Kyocera International
Trading Co. Ltd.,
Beijing**
Tel: +86-10-6588-3528

**AVX/Kyocera India
Liaison Office**
Tel: +91-80-6450-0715

ASIA-KED (KYOCERA Electronic Devices)

KED Hong Kong Ltd.
Tel: +852-2305-1080/1223

**KED Hong Kong Ltd.
Shenzen**
Tel: +86-755-3398-9600

**KED Company Ltd.
Shanghai**
Tel: +86-21-3255-1833

**KED Hong Kong Ltd.
Beijing**
Tel: +86-10-5869-4655

KED Taiwan Ltd.
Tel: +886-2-2950-0268

**KED Korea Yuhan Hoesa,
South Korea**
Tel: +82-2-783-3604/6126

**KED (S) Pte Ltd.
Singapore**
Tel: +65-6509-0328

**Kyocera Corporation
Japan**
Tel: +81-75-604-3449

Contact:



<http://www.avx.com>

S-AP0M1110-C