

Features

- Small SMD package: 2.0 x 1.2 mm (2012)^[1]
- Pin-compatible to 2012 XTAL SMD package
- Fixed 32.768 kHz output frequency
- <20 ppm frequency tolerance
- Ultra-low power: <1 μ A
- Supports coin-cell or super-cap battery backup voltages
- Vdd supply range: 1.5V to 3.63V over -40°C to +85°C
- Oscillator output eliminates external load caps
- Internal filtering eliminates external Vdd bypass cap
- NanoDrive™ programmable output swing for lowest power
- Pb-free, RoHS and REACH compliant

Applications

- Mobile Phones
- Tablets
- Health and Wellness Monitors
- Fitness Watches
- Sport Video Cams
- Wireless Keypads
- Ultra-Small Notebook PC
- Pulse-per-Second (pps) Timekeeping
- RTC Reference Clock
- Battery Management Timekeeping

Note: 1. For the smallest 32 kHz XO in CSP (1.2mm²), consider the SiT1532



Electrical Characteristics

| Parameter | Symbol | Min. | Typ. | Max. | Unit | Condition |
|---|-----------------------|------|--------|-------|-------------|---|
| Frequency and Stability | | | | | | |
| Fixed Output Frequency | F _{out} | | 32.768 | | kHz | |
| Frequency Stability | | | | | | |
| Frequency Tolerance ^[2] | F _{tol} | | | 20 | ppm | T _A = 25°C, post reflow, Vdd: 1.5V – 3.63V. |
| Frequency Stability ^[3] | F _{stab} | | | 75 | ppm | T _A = -10°C to +70°C, Vdd: 1.5V – 3.63V. |
| | | | | 100 | | T _A = -40°C to +85°C, Vdd: 1.5V – 3.63V. |
| | | | | 250 | | T _A = -10°C to +70°C, Vdd: 1.2V – 1.5V. |
| 25°C Aging | | -1 | | 1 | ppm | 1st Year |
| Supply Voltage and Current Consumption | | | | | | |
| Operating Supply Voltage | Vdd | 1.2 | | 3.63 | V | T _A = -10°C to +70°C |
| | | 1.5 | | 3.63 | V | T _A = -40°C to +85°C |
| Core Operating Current ^[4] | I _{dd} | | 0.90 | | μ A | T _A = 25°C, Vdd: 1.8V. No load |
| | | | | 1.3 | | T _A = -10°C to +70°C, Vdd max: 3.63V. No load |
| | | | | 1.4 | | T _A = -40°C to +85°C, Vdd max: 3.63V. No load |
| Output Stage Operating Current ^[4] | I _{dd_out} | | 0.065 | 0.125 | μ A/Vpp | T _A = -40°C to +85°C, Vdd: 1.5V – 3.63V. No load |
| Power-Supply Ramp | t _{Vdd_Ramp} | | | 100 | ms | T _A = -40°C to +85°C, 0 to 90% Vdd |
| Start-up Time at Power-up ^[5] | t _{start} | | 180 | 300 | ms | T _A = 25°C \pm 10°C, valid output |
| | | | | 450 | | T _A = -40°C to +70°C, valid output |
| | | | | 500 | | T _A = +85°C, valid output |
| Operating Temperature Range | | | | | | |
| Commercial Temperature | T _{use} | -10 | | 70 | °C | |
| Industrial Temperature | | -40 | | 85 | °C | |

Notes:

2. Measured peak-to-peak. Tested with Agilent 53132A frequency counter. Due to the low operating frequency, the gate time must be \geq 100 ms to ensure an accurate frequency measurement.
3. Stability is specified for two operating voltage ranges. Stability progressively degrades with supply voltage below 1.5V. Measured peak-to-peak. Inclusive of Initial Tolerance at 25°C, and variations over operating temperature, rated power supply voltage and load.
4. Core operating current does not include output driver operating current or load current. To derive total operating current (no load), add core operating current + (0.065 μ A/V) * (peak-to-peak output Voltage swing).
5. Measured from the time Vdd reaches 1.5V.

Electrical Characteristics (continued)

| Parameter | Symbol | Min. | Typ. | Max. | Unit | Condition |
|---|------------|--------|---------------|-------|-------------------|---|
| LVC MOS Output Option, $T_A = -40^\circ\text{C}$ to $+85^\circ\text{C}$, typical values are at $T_A = 25^\circ\text{C}$ | | | | | | |
| Output Rise/Fall Time | t_r, t_f | | 100 | 200 | ns | 10-90% (Vdd), 15 pF load, Vdd = 1.5V to 3.63V |
| Output Clock Duty Cycle | DC | 48 | | 52 | % | |
| Output Voltage High | VOH | 90% | | | V | Vdd: 1.5V – 3.63V. $I_{OH} = -10 \mu\text{A}$, 15 pF |
| Output Voltage Low | VOL | | | 10% | V | Vdd: 1.5V – 3.63V. $I_{OL} = 10 \mu\text{A}$, 15 pF |
| NanoDrive™ Programmable, Reduced Swing Output | | | | | | |
| Output Rise/Fall Time | t_r, t_f | | | 200 | ns | 30-70% (V_{OL}/V_{OH}), 10 pF Load |
| Output Clock Duty Cycle | DC | 48 | | 52 | % | |
| AC-coupled Programmable Output Swing | V_{sw} | | 0.20 to 0.80 | | V | SiT1533 does not internally AC-couple. This output description is intended for a receiver that is AC-coupled. See Table 2 for acceptable NanoDrive swing options. Vdd: 1.5V – 3.63V, 10 pF Load, $I_{OH} / I_{OL} = \pm 0.2 \mu\text{A}$. |
| DC-Biased Programmable Output Voltage High Range | VOH | | 0.60 to 1.225 | | V | Vdd: 1.5V – 3.63V. $I_{OH} = -0.2 \mu\text{A}$, 10 pF Load. See Table 1 for acceptable V_{OH}/V_{OL} setting levels. |
| DC-Biased Programmable Output Voltage Low Range | VOL | | 0.35 to 0.80 | | V | Vdd: 1.5V – 3.63V. $I_{OL} = 0.2 \mu\text{A}$, 10 pF Load. See Table 1 for acceptable V_{OH}/V_{OL} setting levels. |
| Programmable Output Voltage Swing Tolerance | | -0.055 | | 0.055 | V | $T_A = -40^\circ\text{C}$ to $+85^\circ\text{C}$, Vdd = 1.5V to 3.63V. |
| Period Jitter | T_{jitt} | | 35 | | ns _{RMS} | Cycles = 10,000, $T_A = 25^\circ\text{C}$, Vdd = 1.5V – 3.63V |

Pin Configuration

| SMD Pin | Symbol | I/O | Functionality |
|---------|---------|---------------------|--|
| 1 | NC | No Connect | No Connect. Will not respond to any input signal. When interfacing to an MCU's XTAL input pins, this pin is typically connected to the receiving IC's X Out pin. In this case, the SiT1533 will not be affected by the signal on this pin. If not interfacing to an XTAL oscillator, leave pin 1 floating (no connect). |
| 2 | GND | Power Supply Ground | Connect to ground. All GND pins must be connected to power supply ground. |
| 3 | CLK Out | OUT | Oscillator clock output. When interfacing to an MCU's XTAL, the CLK Out is typically connected to the receiving IC's X IN pin. The SiT1533 oscillator output includes an internal driver. As a result, the output swing and operation is not dependent on capacitive loading. This makes the output much more flexible, layout independent, and robust under changing environmental and manufacturing conditions. |
| 4 | Vdd | Power Supply | Connect to power supply $1.5\text{V} \leq V_{dd} \leq 3.63\text{V}$ for operation over -40°C to $+85^\circ\text{C}$ temperature range. Under normal operating conditions, Vdd does not require external bypass/decoupling capacitor(s). Internal power supply filtering will reject more than $\pm 150 \text{ mV/pp}$ with frequency components through 10 MHz. Contact factory for applications that require a wider operating supply voltage range. |

SMD Package (Top View)

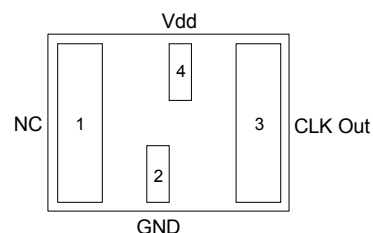

System Block Diagram

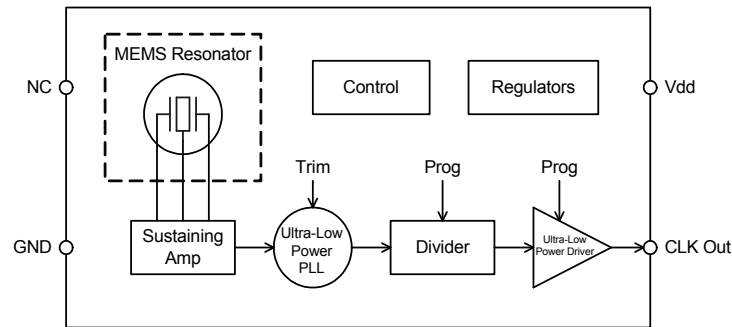

Figure 1.

Absolute Maximum

Attempted operation outside the absolute maximum ratings may cause permanent damage to the part. Actual performance of the IC is only guaranteed within the operational specifications, not at absolute maximum ratings.

| Parameter | Test Condition | Value | Unit |
|--|----------------------------------|----------------|------|
| Continuous Power Supply Voltage Range (Vdd) | | -0.5 to 3.63 | V |
| Short Duration Maximum Power Supply Voltage (Vdd) | ≤30 minutes, over -40°C to +85°C | 4.0 | V |
| Continuous Maximum Operating Temperature Range | Vdd = 1.5V - 3.63V | 105 | °C |
| Short Duration Maximum Operating Temperature Range | Vdd = 1.5V - 3.63V, ≤30 mins | 125 | °C |
| Human Body Model ESD Protection | HBM, JESD22-A114 | 3000 | V |
| Charge-Device Model (CDM) ESD Protection | JESD220C101 | 750 | V |
| Machine Model (MM) ESD Protection | T _A = 25°C | 300 | V |
| Latch-up Tolerance | JESD78 Compliant | | |
| Mechanical Shock Resistance | Mil 883, Method 2002 | 10,000 | g |
| Mechanical Vibration Resistance | Mil 883, Method 2007 | 70 | g |
| 2012 SMD Junction Temperature | | 150 | °C |
| Storage Temperature | | -65°C to 150°C | |

Description

The SiT1533 is an ultra-small and ultra-low power 32.768 kHz oscillator optimized for mobile and other battery-powered applications. The SiT1533 is pin-compatible and footprint compatible to existing 2012 XTALs when using the SiTime solder-pad layout (SPL). And unlike standard oscillators, the SiT1533 features NanoDrive™, a factory programmable output that reduces the voltage swing to minimize power.

The 1.2V to 3.63V operating supply voltage range makes it an ideal solution for mobile applications that incorporate a low-voltage, battery-back-up source such as a coin-cell or super-cap.

SiTime's MEMS oscillators consist of MEMS resonators and a programmable analog circuit. Our MEMS resonators are built with SiTime's unique MEMS First™ process. A key manufacturing step is EpiSeal™ during which the MEMS resonator is annealed with temperatures over 1000°C. EpiSeal creates an extremely strong, clean, vacuum chamber that encapsulates the MEMS resonator and ensures the best performance and reliability. During EpiSeal, a poly silicon cap is grown on top of the resonator cavity, which eliminates the need for additional cap wafers or other exotic packaging. As a result, SiTime's MEMS resonator die can be used like any other semiconductor die. One unique result of SiTime's MEMS First and EpiSeal manufacturing processes is the capability to integrate SiTime's MEMS die with a SOC, ASIC, microprocessor or analog die within a package to eliminate external timing components and provide a highly integrated, smaller, cheaper solution to the customer.

XTAL Footprint Compatibility (SMD Package)

The SiT1533 is a replacement to the 32 kHz XTAL in the 2.0 x 1.2 mm (2012) package. Unlike XTAL resonators, SiTime's silicon MEMS oscillators require a power supply (Vdd) and ground (GND) pin. Vdd and GND pins are conveniently placed between the two large XTAL pins. When using the SiTime Solder Pad Layout (SPL), the SiT1533 footprint is compatible with existing 32 kHz XTALs in the 2012 SMD package. Figure 2 shows the comparison between the quartz XTAL footprint and the SiTime footprint. For applications that require the smallest footprint solution, consider the SiT1532 XO available in a 1.2mm² CSP.

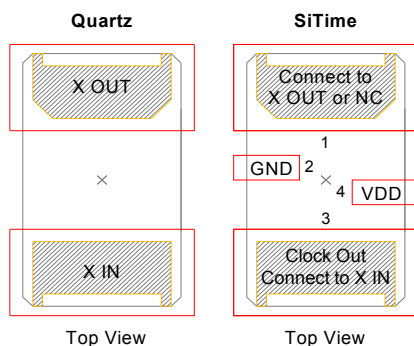

Figure 2. SiT1533 Footprint Compatibility with Quartz XTAL Footprint [6]

Note:

6. On the SiTime device, X IN is not internally connected and will not respond to any signal. It is acceptable to connect to chipset X OUT.

Frequency Stability

The SiT1533 is factory calibrated (trimmed) to guarantee frequency stability to be less than 20 ppm at room temperature and less than 100 ppm over the full -40°C to +85°C temperature range. Unlike quartz crystals that have a classic tuning fork parabola temperature curve with a 25°C turnover point, the SiT1533 temperature coefficient is extremely flat across temperature. The device maintains less than 100 ppm frequency stability over the full operating temperature range when the operating voltage is between 1.5 and 3.63V as shown in Figure 3.

Functionality is guaranteed over the 1.2V - 3.63V operating supply voltage range. However, frequency stability degrades below 1.5V and steadily degrades as it approaches the 1.2V minimum supply due to the internal regulator limitations. Between 1.2V and 1.5V, the frequency stability is 250 ppm max over temperature.

When measuring the SiT1533 output frequency with a frequency counter, it is important to make sure the counter's gate time is ≥ 100 ms. The slow frequency of a 32 kHz clock will give false readings with faster gate times.

For applications that require a wider supply voltage range >3.63V, or operating frequency below 32 kHz, see the alternative 32 kHz product options on the SiTime web site; www.sitime.com.

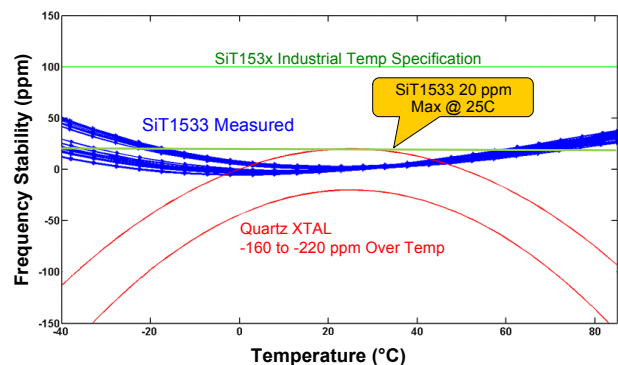

Figure 3. SiTime vs. Quartz

Power Supply Noise Immunity

The SiT1533 is an ultra-small 32 kHz oscillator. In addition to eliminating external output load capacitors common with standard XTALs, this device includes special power supply filtering and thus, eliminates the need for an external Vdd bypass-decoupling capacitor. This feature further simplifies the design and keeps the footprint as small as possible. Internal power supply filtering is designed to reject AC-noise greater than ± 150 mVpp magnitude and beyond 10 MHz frequency component.

Output Voltage

The SiT1533 has two output voltage options. One option is a standard LVCMOS output swing. The second option is the NanoDrive reduced swing output. Output swing is customer specific and programmed between 200 mV and 800 mV. For

DC-coupled applications, output V_{OH} and V_{OL} are individually factory programmed to the customers' requirement. V_{OH} programming range is between 600 mV and 1.225V in 100 mV increments. Similarly, V_{OL} programming range is between 350 mV and 800 mV. For example; a PMIC or MCU is internally 1.8V logic compatible, and requires a 1.2V V_{IH} and a 0.6V V_{IL} . Simply select SiT1533 NanoDrive factory programming code to be "D14" and the correct output thresholds will match the downstream PMIC or MCU input requirements. Interface logic will vary by manufacturer and we recommend that you review the input voltage requirements for the input interface.

For DC-biased NanoDrive output configuration, the minimum V_{OL} is limited to 350mV and the maximum allowable swing ($V_{OH} - V_{OL}$) is 750mV. For example, 1.1V V_{OH} and 400mV V_{OL} is acceptable, but 1.2V V_{OH} and 400 mV V_{OL} is not acceptable.

When the output is interfacing to an XTAL input that is internally AC-coupled, the SiT1533 output can be factory programmed to match the input swing requirements. For example, if a PMIC or MCU input is internally AC-coupled and requires an 800mV swing, then simply choose the SiT1533 NanoDrive programming code "AA8" in the part number. It is important to note that the SiT1533 does not include internal AC-coupling capacitors. Please see the *Part Number Ordering* section at the end of the datasheet for more information about the part number ordering scheme.

Power-up

The SiT1533 starts-up to a valid output frequency within 300 ms (150ms typ). To ensure the device starts-up within the specified limit, make sure the power-supply ramps-up in approximately 10 - 20 ms (to within 90% of Vdd). Start-up time is measured from the time Vdd reaches 1.5V. For applications that operate between 1.2V and 1.5V, the start-up time will be longer.

SiT1533 NanoDrive™

Figure 4 shows a typical SiT1533 output waveform (into a 10 pF load) when factory programmed for a 0.70V swing and DC bias (V_{OH}/V_{OL}) for 1.8V logic:

Example:

- NanoDrive™ part number coding: D14. Example part number: SiT1533AI-H4-D14-32.768
- $V_{OH} = 1.1V$, $V_{OL} = 0.4V$ ($V_{SW} = 0.70V$)

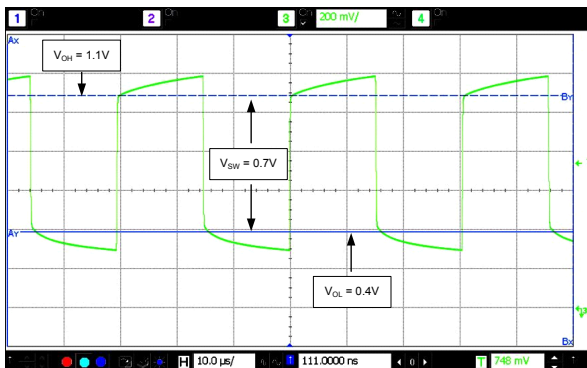

Figure 4. SiT1533AI-H4-D14-32.768 Output Waveform (10 pF load)

Table 1 shows the supported NanoDrive™ V_{OH} , V_{OL} factory programming options.

Table 1. Acceptable V_{OH}/V_{OL} NanoDrive™ Levels

| V_{OL}/V_{OH} | 1.225 | 1.100 | 1.000 | 0.900 | 0.800 | 0.700 | 0.600 |
|-----------------|-------|-------|-------|-------|-------|-------|-------|
| 0.800 | D28 | D18 | D08 | | | | |
| 0.700 | D27 | D17 | D07 | D97 | | | |
| 0.525 | D26 | D16 | D06 | D96 | D86 | | |
| 0.500 | D25 | D15 | D05 | D95 | D85 | D75 | |
| 0.400 | | D14 | D04 | D94 | D84 | D74 | D64 |
| 0.350 | | D13 | D03 | D93 | D83 | D73 | D63 |

Table 2 shows the supported AC coupled Swing levels. The "AC-coupled" terminology refers to the programming description for applications where the downstream chipset includes an internal AC-coupling capacitor, and therefore, only the output swing is important and V_{OH}/V_{OL} are not relevant.

Table 2. Acceptable AC-Coupled Swing Levels

| Swing | 0.800 | 0.700 | 0.600 | 0.500 | 0.400 | 0.300 | 0.250 | 0.200 |
|-------------|-------|-------|-------|-------|-------|-------|-------|-------|
| Output Code | AA8 | AA7 | AA6 | AA5 | AA4 | AA3 | AA2 | AA1 |

Example:

- NanoDrive part number coding: AA2. Example part number: SiT1533AI-D4-AA2-32.768
- Output voltage swing: 0.250V

The values listed in Tables 1 and -2 are nominal values at 25°C and will exhibit a tolerance of ±55 mV across Vdd and -40°C to 85°C operating temperature range.

SiT1533 Full Swing LVCMOS Output

The SiT1533 can be factory programmed to generate full-swing LVCMOS levels. Figure 5 shows the typical LVCMOS waveform ($V_{dd} = 1.8V$) at room temperature into a 15 pF load.

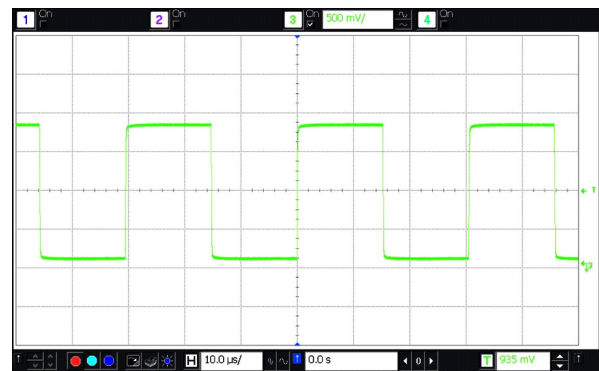

Figure 5. LVCMOS Waveform ($V_{dd} = 1.8V$) into 15 pF Load

Example:

- LVCMOS output part number coding is always DCC
- Example part number: SiT1533AI-H4-DCC-32.768

Calculating Load Current

No Load Supply Current

When calculating no-load power for the SiT1533, the core and output driver components need to be added. Since the output voltage swing can be programmed for reduced swing between 250 mV and 800 mV, the output driver current is variable. Therefore, no-load operating supply current is broken into two sections; core and output driver. The equation is as follows:

$$\text{Total Supply Current (no load)} = I_{\text{dd Core}} + (65\text{nA/V})(V_{\text{out_pp}})$$

Example 1: Full-swing LVCMOS

- Vdd = 1.8V
- Idd Core = 900nA (typ)
- Vout_pp = 1.8V (LVCMOS)

$$\text{Supply Current} = 900\text{nA} + (65\text{nA/V})(1.8\text{V}) = 1017\text{nA}$$

Example 2: NanoDrive™ Reduced Swing

- Vdd = 1.8V
- Idd Core = 900nA (typ)
- Vout_pp (Programmable) = $V_{\text{OH}} - V_{\text{OL}} = 1.1\text{V} - 0.6\text{V} = 500\text{mV}$

$$\text{Supply Current} = 900\text{nA} + (65\text{nA/V})(0.5\text{V}) = 932\text{nA}$$

Total Supply Current with Load

To calculate the total supply current, including the load, follow the equation listed below. Note the 30% reduction in power with NanoDrive™.

$$\text{Total Current} = I_{\text{dd Core}} + I_{\text{dd Output Driver}} (65\text{nA/V} \cdot V_{\text{out_pp}}) + \text{Load Current} (C \cdot V \cdot F)$$

Example 1: Full-swing LVCMOS

- Vdd = 1.8V
- Idd Core = 900nA
- Load Capacitance = 10pF
- Idd Output Driver: $(65\text{nA/V})(1.8\text{V}) = 117\text{nA}$
- Load Current: $(10\text{pF})(1.8\text{V})(32.768\text{kHz}) = 590\text{nA}$
- Total Current = $900\text{nA} + 117\text{nA} + 590\text{nA} = 1.6\mu\text{A}$

Example 2: NanoDrive™ Reduced Swing

- Vdd = 1.8V
- Idd Core = 900nA
- Load Capacitance = 10pF
- Vout_pp (Programmable): $V_{\text{OH}} - V_{\text{OL}} = 1.1\text{V} - 0.6\text{V} = 500\text{mV}$
- Idd Output Driver: $(65\text{nA/V})(0.5\text{V}) = 33\text{nA}$
- Load Current: $(10\text{pF})(0.5\text{V})(32.768\text{kHz}) = 164\text{nA}$
- Total Current = $900\text{nA} + 33\text{nA} + 164\text{nA} = 1.1\mu\text{A}$

Typical Operating Curves

($T_A = 25^\circ\text{C}$, $V_{dd} = 1.8\text{V}$, unless otherwise stated)

Initial Tolerance Histogram

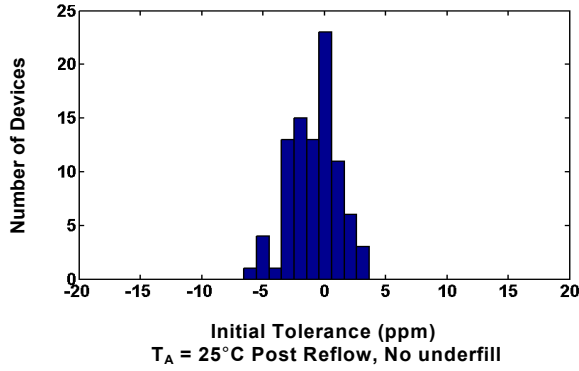

Frequency Stability Over Temperature

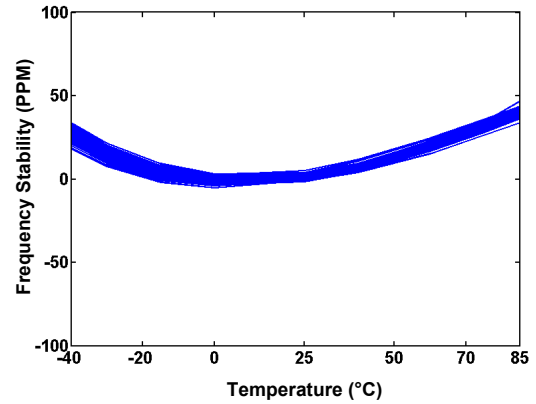

Core Current Over Temperature

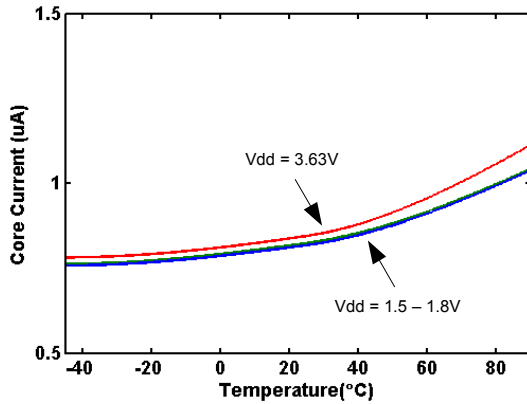

Output Stage Current Over Temperature

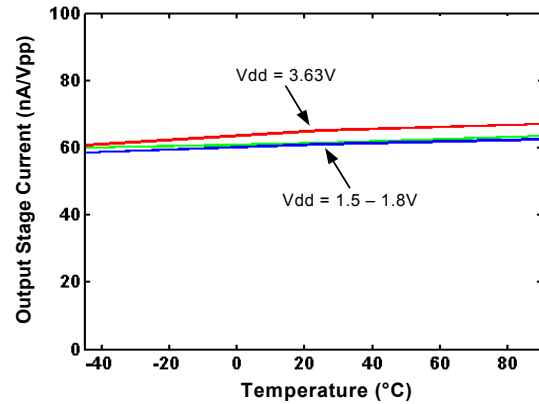

Start-up Time

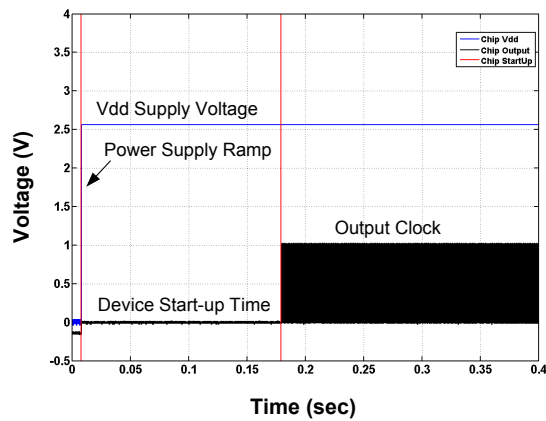

Power Supply Noise Rejection (+/-150mV Noise)

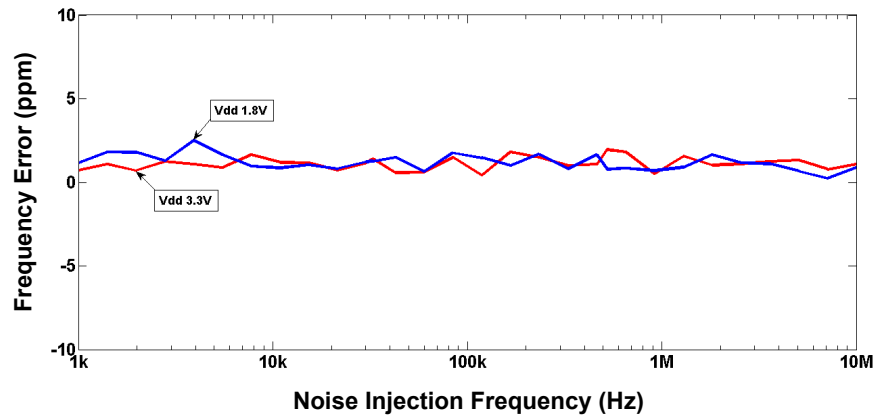

NanoDrive™ Output Waveform

($V_{OH} = 1.1V$, $V_{OL} = 0.4V$; SiT1533AI-H4-D14-32.768)

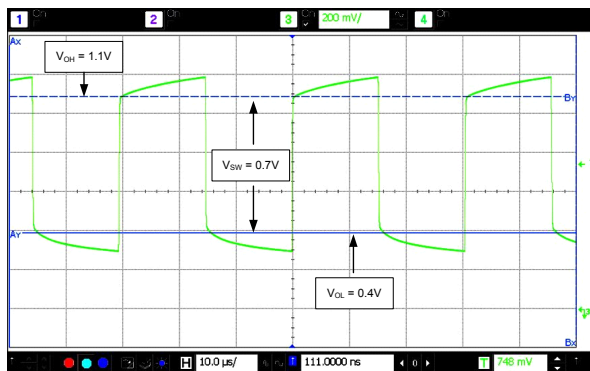

LVC MOS Output Waveform

($V_{swing} = 1.8V$, SiT1533AI-H4-DCC-32.768)

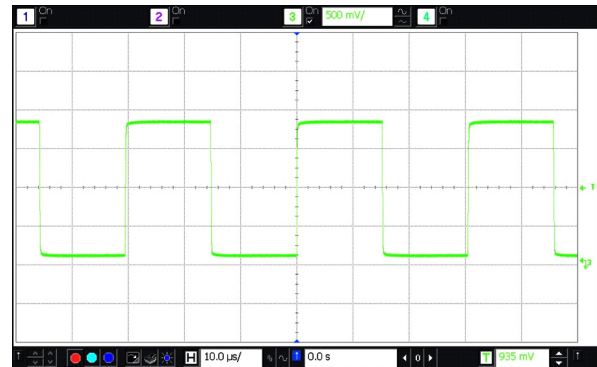

Dimensions and Patterns

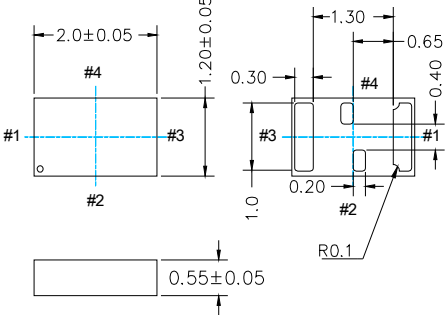
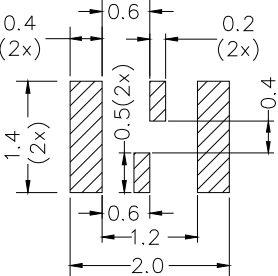
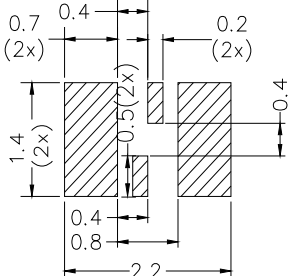
| Package Size – Dimensions (Unit: mm) ^[7] | Recommended Land Pattern (Unit: mm) | |
|---|--|--|
| <p>2.0 x 1.2 mm SMD</p>  <p>Dimensions: 2.0±0.05, 1.20±0.05, 0.30, 1.30, 0.65, 0.40, 0.20, 1.0, 0.55±0.05, R0.1. Marking locations: #1, #2, #3, #4.</p> | <p>SiTime Only SPL</p>  <p>Dimensions: 0.4 (2x), 0.6, 0.2 (2x), 1.4 (2x), 0.5 (2x), 0.4, 0.6, 1.2, 2.0.</p> | <p>XTAL Compatible SPL</p>  <p>Dimensions: 0.7 (2x), 0.4, 0.2 (2x), 1.4 (2x), 0.5 (2x), 0.4, 0.8, 2.2.</p> |

Note:

7. Top marking: Y denotes manufacturing origin and XXXX denotes manufacturing lot number. The value of "Y" will depend on the assembly location of the device.

Manufacturing Guidelines

- 1) No Ultrasonic Cleaning: Do not subject the SiT1533 to an ultrasonic cleaning environment. Permanent damage or long term reliability issues to the MEMS structure may occur.
- 2) For additional manufacturing guidelines and marking/tape-reel instructions, click on the following link: http://www.sitime.com/component/docman/doc_download/243-manufacturing-notes-for-sitime-oscillators

Ordering Information

Part number characters in blue represent the customer specific options. The other characters in the part number are fixed. Here are guidelines to select the correct output voltage. These are only suggestions and specific chipsets may require different output voltage settings.

- 1) For XTAL replacement applications that will keep the chipset oscillator enabled, configure the NanoDrive™ output for a swing similar to the XTAL, approximately 250mV.
→ SiT1533AI-H4-AA2-32.768
- 2) For XTAL replacement applications that will disable the chipset oscillator, configure the output with one of the following:
 - For VDD = 1.8V: SiT1533AI-H4-D14-32.768
 - For VDD > 1.8V: SiT1533AI-H4-DCC-32.768

The following examples illustrate how to select the appropriate temp range and output voltage requirements:

Example 1: SiT1533AI-H4-D14-32.768

- Industrial temp & corresponding 100 ppm frequency stability. Note, 100 ppm is only available for the industrial temp range, and 75 ppm is only available for the commercial temp range.
- Output swing requirements:
 - a) "D" = DC-coupled receiver
 - b) "1" = $V_{OH} = 1.1V$
 - c) "4" = $V_{OL} = 0.4V$

Example 2: SiT1533AC-H5-AA2-32.768

- Commercial temp & corresponding 75 ppm frequency stability. Note, 100 ppm is only available for the industrial temp range, and 75 ppm is only available for the commercial temp range.
- Output swing requirements:
 - a) "A" = AC-coupled receiver
 - b) "A" = AC-coupled receiver
 - c) "2" = 250mV swing

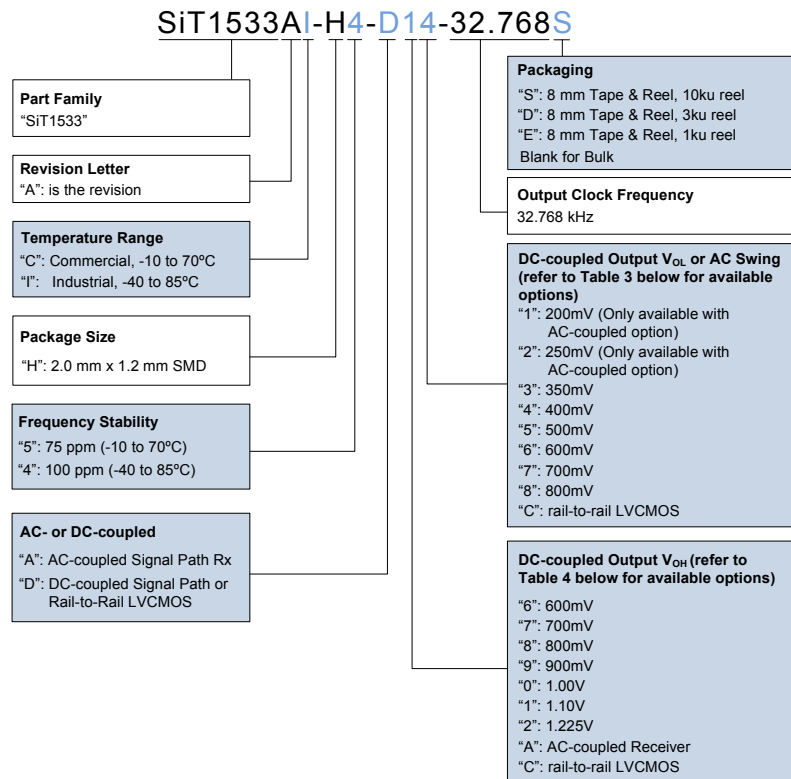

Revision History

| Version | Release Date | Change Summary |
|---------|--------------|---|
| 1.0 | 9/2/14 | Rev 0.9 Preliminary to Rev 1.0 Production Release <ul style="list-style-type: none">• Updated start-up time specification• Added typical operating plots• Removed SOT23 package option• Relabeled 25°C frequency spec as <i>frequency tolerance</i>• Added Manufacturing Guidelines section |

© SiTime Corporation 2014. The information contained herein is subject to change at any time without notice. SiTime assumes no responsibility or liability for any loss, damage or defect of a Product which is caused in whole or in part by (i) use of any circuitry other than circuitry embodied in a SiTime product, (ii) misuse or abuse including static discharge, neglect or accident, (iii) unauthorized modification or repairs which have been soldered or altered during assembly and are not capable of being tested by SiTime under its normal test conditions, or (iv) improper installation, storage, handling, warehousing or transportation, or (v) being subjected to unusual physical, thermal, or electrical stress.

Disclaimer: SiTime makes no warranty of any kind, express or implied, with regard to this material, and specifically disclaims any and all express or implied warranties, either in fact or by operation of law, statutory or otherwise, including the implied warranties of merchantability and fitness for use or a particular purpose, and any implied warranty arising from course of dealing or usage of trade, as well as any common-law duties relating to accuracy or lack of negligence, with respect to this material, any SiTime product and any product documentation. Products sold by SiTime are not suitable or intended to be used in a life support application or component, to operate nuclear facilities, or in other mission critical applications where human life may be involved or at stake. All sales are made conditioned upon compliance with the critical uses policy set forth below.

CRITICAL USE EXCLUSION POLICY
BUYER AGREES NOT TO USE SITIME'S PRODUCTS FOR ANY APPLICATION OR IN ANY COMPONENTS USED IN LIFE SUPPORT DEVICES OR TO OPERATE NUCLEAR FACILITIES OR FOR USE IN OTHER MISSION-CRITICAL APPLICATIONS OR COMPONENTS WHERE HUMAN LIFE OR PROPERTY MAY BE AT STAKE.

SiTime owns all rights, title and interest to the intellectual property related to SiTime's products, including any software, firmware, copyright, patent, or trademark. The sale of SiTime products does not convey or imply any license under patent or other rights. SiTime retains the copyright and trademark rights in all documents, catalogs and plans supplied pursuant to or ancillary to the sale of products or services by SiTime. Unless otherwise agreed to in writing by SiTime, any reproduction, modification, translation, compilation, or representation of this material shall be strictly prohibited.