



# ULTRALOW-NOISE, HIGH-PSRR, FAST, RF, 500-mA LOW-DROPOUT LINEAR REGULATORS

 Check for Samples: [TPS795xx](#)

## FEATURES

- 500-mA Low-Dropout Regulator With Enable
- Available in Fixed and Adjustable (1.2-V to 5.5-V) Versions
- High PSRR (50 dB at 10 kHz)
- Ultralow Noise (33  $\mu\text{V}_{\text{RMS}}$ , TPS79530)
- Fast Start-Up Time (50  $\mu\text{s}$ )
- Stable With a 1- $\mu\text{F}$  Ceramic Capacitor
- Excellent Load/Line Transient Response
- Low Dropout Voltage (110 mV at Full Load, TPS79530)
- 6-Pin SOT223 and 3 x 3 SON Packages

## APPLICATIONS

- RF: VCOs, Receivers, ADCs
- Audio
- Bluetooth<sup>®</sup>, Wireless LAN
- Cellular and Cordless Telephones
- Handheld Organizers, PDAs

## DESCRIPTION

The TPS795xx family of low-dropout (LDO), low-power linear voltage regulators features high power-supply rejection ratio (PSRR), ultralow noise, fast start-up, and excellent line and load transient responses in small outline, SOT223-6 and 3 x 3 SON packages. Each device in the family is stable with a small 1- $\mu\text{F}$  ceramic capacitor on the output. The family uses an advanced, proprietary BiCMOS fabrication process to yield extremely low dropout voltages (for example, 110 mV at 500 mA). Each device achieves fast start-up times (approximately 50  $\mu\text{s}$  with a 0.001- $\mu\text{F}$  bypass capacitor) while consuming very low quiescent current (265  $\mu\text{A}$ , typical). Moreover, when the device is placed in standby mode, the supply current is reduced to less than 1  $\mu\text{A}$ . The TPS79530 exhibits approximately 33  $\mu\text{V}_{\text{RMS}}$  of output voltage noise at 3-V output with a 0.1- $\mu\text{F}$  bypass capacitor. Applications with analog components that are noise-sensitive, such as portable RF electronics, benefit from the high-PSRR and low-noise features, as well as from the fast response time.

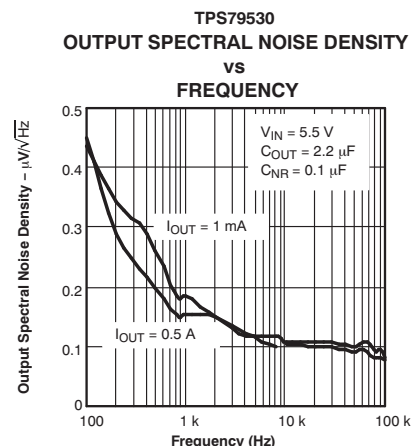
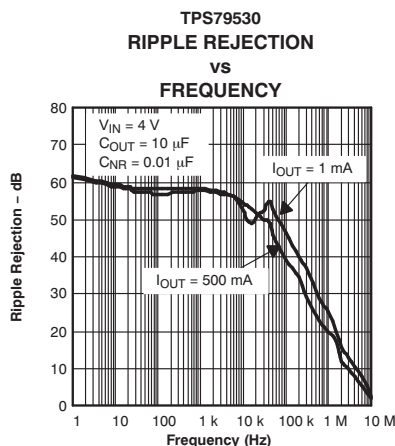
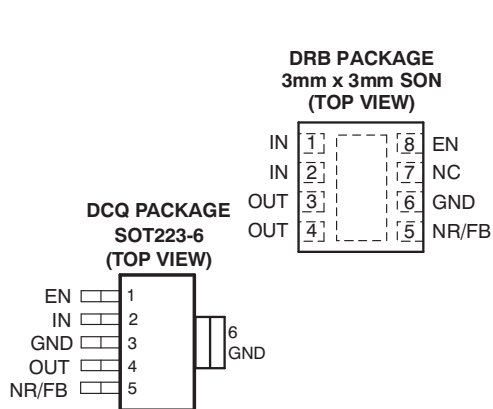

Please be aware that an important notice concerning availability, standard warranty, and use in critical applications of Texas Instruments semiconductor products and disclaimers thereto appears at the end of this data sheet.

Bluetooth is a registered trademark of Bluetooth SIG, Inc.  
All other trademarks are the property of their respective owners.



This integrated circuit can be damaged by ESD. Texas Instruments recommends that all integrated circuits be handled with appropriate precautions. Failure to observe proper handling and installation procedures can cause damage.

ESD damage can range from subtle performance degradation to complete device failure. Precision integrated circuits may be more susceptible to damage because very small parametric changes could cause the device not to meet its published specifications.

### ORDERING INFORMATION<sup>(1)</sup>

PRODUCT	V <sub>OUT</sub> <sup>(2)</sup>
TPS795xx yyy z	<b>XX</b> is nominal output voltage (for example, 28 = 2.8 V, 285 = 2.85 V, 01 = Adjustable). <b>YYY</b> is package designator. <b>Z</b> is package quantity.

- (1) For the most current package and ordering information, see the Package Option Addendum at the end of this document, or see the TI website at [www.ti.com](http://www.ti.com).
- (2) Output voltages from 1.3 V to 5.0 V in 100 mV increments are available; minimum order quantities may apply. Contact factory for details and availability.

### ABSOLUTE MAXIMUM RATINGS

over operating temperature (unless otherwise noted)<sup>(1)</sup>

	VALUE
V <sub>IN</sub> range	–0.3 V to 6 V
V <sub>EN</sub> range	–0.3 V to V <sub>IN</sub> + 0.3 V
V <sub>OUT</sub> range	6 V
Peak output current	Internally limited
ESD rating, HBM	2 kV
ESD rating, CDM	500 V
Continuous total power dissipation	See the Thermal Information Table
Junction temperature range, T <sub>J</sub>	–40°C to +150°C
Storage temperature range, T <sub>stg</sub>	–65°C to +150°C

- (1) Stresses above these ratings may cause permanent damage. Exposure to absolute maximum conditions for extended periods may degrade device reliability. These are stress ratings only, and functional operation of the device at these or any other conditions beyond those specified is not implied.

**THERMAL INFORMATION**

THERMAL METRIC <sup>(1)(2)</sup>		TPS795xx <sup>(3)</sup>		UNITS
		DRB (8 PINS)	DCQ (6 PINS)	
$\theta_{JA}$	Junction-to-ambient thermal resistance <sup>(4)</sup>	47.8	70.4	°C/W
$\theta_{JcTop}$	Junction-to-case (top) thermal resistance <sup>(5)</sup>	83	70	
$\theta_{JB}$	Junction-to-board thermal resistance <sup>(6)</sup>	n/a	n/a	
$\psi_{JT}$	Junction-to-top characterization parameter <sup>(7)</sup>	2.1	6.8	
$\psi_{JB}$	Junction-to-board characterization parameter <sup>(8)</sup>	17.8	30.1	
$\theta_{Jcbot}$	Junction-to-case (bottom) thermal resistance <sup>(9)</sup>	12.1	6.3	

- (1) For more information about traditional and new thermal metrics, see the [IC Package Thermal Metrics application report, SPRA953A](#).
- (2) For thermal estimates of this device based on PCB copper area, see the [TI PCB Thermal Calculator](#).
- (3) Thermal data for the RGW and DRC packages are derived by thermal simulations based on JEDEC-standard methodology as specified in the JESD51 series. The following assumptions are used in the simulations:
  - (a) i. DRB: The exposed pad is connected to the PCB ground layer through a 2x2 thermal via array.
  - ii. DCQ: The exposed pad is connected to the PCB ground layer through a 3x2 thermal via array.
  - (b) i. DRB: The top and bottom copper layers are assumed to have a 20% thermal conductivity of copper representing a 20% copper coverage.
  - ii. DCQ: Each of top and bottom copper layers has a dedicated pattern for 20% copper coverage.
  - (c) These data were generated with only a single device at the center of a JEDEC high-K (2s2p) board with 3in x 3in copper area. To understand the effects of the copper area on thermal performance, see the [Power Dissipation](#) and [Estimating Junction Temperature](#) sections of this data sheet.
- (4) The junction-to-ambient thermal resistance under natural convection is obtained in a simulation on a JEDEC-standard, high-K board, as specified in JESD51-7, in an environment described in JESD51-2a.
- (5) The junction-to-case (top) thermal resistance is obtained by simulating a cold plate test on the top of the package. No specific JEDEC-standard test exists, but a close description can be found in the ANSI SEMI standard G30-88.
- (6) The junction-to-board thermal resistance is obtained by simulating in an environment with a ring cold plate fixture to control the PCB temperature, as described in JESD51-8.
- (7) The junction-to-top characterization parameter,  $\psi_{JT}$ , estimates the junction temperature of a device in a real system and is extracted from the simulation data to obtain  $\theta_{JA}$  using a procedure described in JESD51-2a (sections 6 and 7).
- (8) The junction-to-board characterization parameter,  $\psi_{JB}$ , estimates the junction temperature of a device in a real system and is extracted from the simulation data to obtain  $\theta_{JA}$  using a procedure described in JESD51-2a (sections 6 and 7).
- (9) The junction-to-case (bottom) thermal resistance is obtained by simulating a cold plate test on the exposed (power) pad. No specific JEDEC standard test exists, but a close description can be found in the ANSI SEMI standard G30-88.

## ELECTRICAL CHARACTERISTICS

Over recommended operating temperature range ( $T_J = -40^\circ\text{C}$  to  $+125^\circ\text{C}$ ),  $V_{EN} = V_{IN}$ ,  $V_{IN} = V_{OUT(nom)} + 1\text{ V}^{(1)}$ ,  $I_{OUT} = 1\text{ mA}$ ,  $C_{OUT} = 10\text{ }\mu\text{F}$ ,  $C_{NR} = 0.01\text{ }\mu\text{F}$ , unless otherwise noted. Typical values are at  $+25^\circ\text{C}$ .

PARAMETER		TEST CONDITIONS	MIN	TYP	MAX	UNIT		
Input voltage, $V_{IN}^{(1)}$			2.7		5.5	V		
Internal reference, $V_{FB}$ (TPS79501)			1.200	1.225	1.250	V		
Continuous output current, $I_{OUT}$			0		500	mA		
Output voltage	Output voltage range	TPS79501	1.225		$5.5 - V_{DO}$	V		
	Accuracy	TPS79501 <sup>(2)</sup>	$0\text{ }\mu\text{A} \leq I_{OUT} \leq 500\text{ mA}$ , $V_{OUT} + 1\text{ V} \leq V_{IN} \leq 5.5\text{ V}^{(1)}$		$0.98(V_{OUT})$	$V_{OUT}$	$1.02(V_{OUT})$	V
		Fixed $V_{OUT}$	$0\text{ }\mu\text{A} \leq I_{OUT} \leq 500\text{ mA}$ , $V_{OUT} + 1\text{ V} \leq V_{IN} \leq 5.5\text{ V}^{(1)}$		-2.0		+2.0	%
Output voltage line regulation ( $\Delta V_{OUT}\%/\Delta V_{IN}$ ) <sup>(1)</sup>		$V_{OUT} + 1\text{ V} \leq V_{IN} \leq 5.5\text{ V}$		0.05	0.12	%/V		
Load regulation ( $\Delta V_{OUT}\%/\Delta I_{OUT}$ )		$0\text{ }\mu\text{A} \leq I_{OUT} \leq 500\text{ mA}$ ,		3		mV		
Dropout voltage <sup>(3)</sup> $V_{IN} = V_{OUT(nom)} - 0.1\text{ V}$	TPS79530	$I_{OUT} = 500\text{ mA}$		110	170	mV		
	TPS79533	$I_{OUT} = 500\text{ mA}$		105	160			
Output current limit		$V_{OUT} = 0\text{ V}$	2.4	2.8	4.2	A		
Ground pin current		$0\text{ }\mu\text{A} \leq I_{OUT} \leq 500\text{ mA}$		265	385	$\mu\text{A}$		
Shutdown current <sup>(4)</sup>		$V_{EN} = 0\text{ V}$ , $2.7\text{ V} \leq V_{IN} \leq 5.5\text{ V}$		0.07	1	$\mu\text{A}$		
FB pin current		$V_{FB} = 1.225\text{ V}$			1	$\mu\text{A}$		
Power-supply ripple rejection	TPS79530	$f = 100\text{ Hz}$ , $I_{OUT} = 10\text{ mA}$		59		dB		
		$f = 100\text{ Hz}$ , $I_{OUT} = 500\text{ mA}$		58				
		$f = 10\text{ kHz}$ , $I_{OUT} = 500\text{ mA}$		50				
		$f = 100\text{ kHz}$ , $I_{OUT} = 500\text{ mA}$		39				
Output noise voltage (TPS79530)	BW = 100 Hz to 100 kHz, $I_{OUT} = 500\text{ mA}$	$C_{NR} = 0.001\text{ }\mu\text{F}$		46		$\mu\text{V}_{RMS}$		
		$C_{NR} = 0.0047\text{ }\mu\text{F}$		41				
		$C_{NR} = 0.01\text{ }\mu\text{F}$		35				
		$C_{NR} = 0.1\text{ }\mu\text{F}$		33				
Time, start-up (TPS79530)	$R_L = 6\text{ }\Omega$ , $C_{OUT} = 1\text{ }\mu\text{F}$	$C_{NR} = 0.001\text{ }\mu\text{F}$		50		$\mu\text{s}$		
		$C_{NR} = 0.0047\text{ }\mu\text{F}$		75				
		$C_{NR} = 0.01\text{ }\mu\text{F}$		110				
High-level enable input voltage		$2.7\text{ V} \leq V_{IN} \leq 5.5\text{ V}$	1.7		$V_{IN}$	V		
Low-level enable input voltage		$2.7\text{ V} \leq V_{IN} \leq 5.5\text{ V}$			0.7	V		
EN pin current		$V_{EN} = 0\text{ V}$	1		1	$\mu\text{A}$		
UVLO threshold		$V_{CC}$ rising	2.25		2.65	V		
UVLO hysteresis				100		mV		

- (1) Minimum  $V_{IN}$  is 2.7 V or  $V_{OUT} + V_{DO}$ , whichever is greater.
- (2) Tolerance of external resistors not included in this specification.
- (3) Dropout is not measured for the TPS79501 and TPS79525 since minimum  $V_{IN} = 2.7\text{ V}$ .
- (4) For adjustable version, this applies only after  $V_{IN}$  is applied; then  $V_{EN}$  transitions high to low.

**FUNCTIONAL BLOCK DIAGRAM—ADJUSTABLE VERSION**

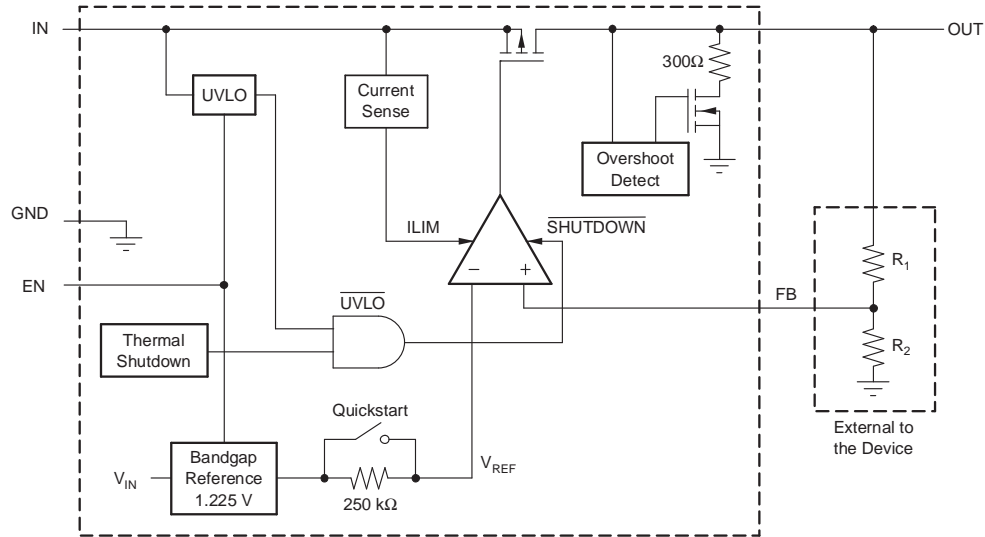

**FUNCTIONAL BLOCK DIAGRAM—FIXED VERSION**

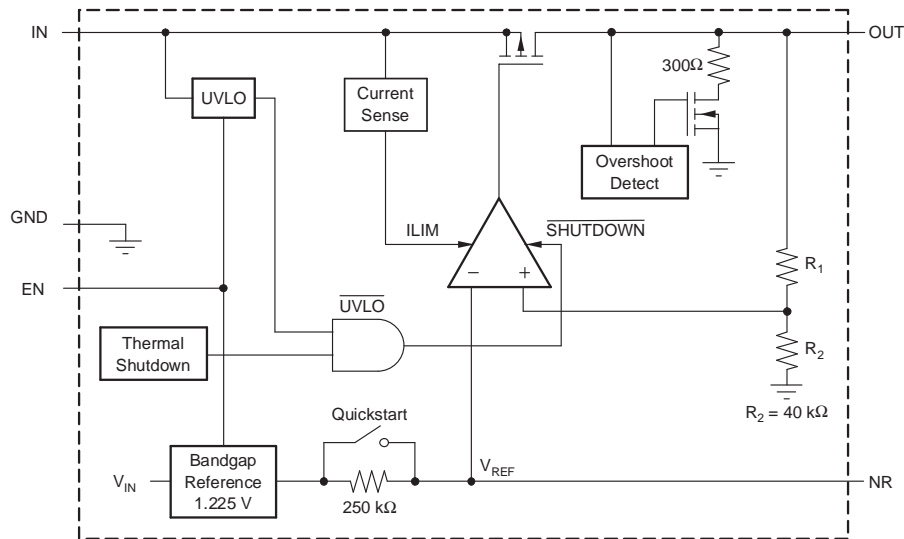
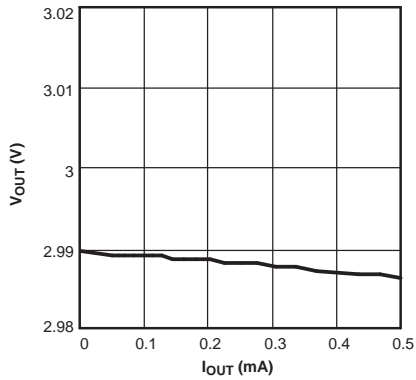

**Table 1. Terminal Functions**

NAME	SOT223 (DCQ) PIN NO.	3x3 SON (DRB) PIN NO.	DESCRIPTION
IN	2	1, 2	Unregulated input to the device
GND	3, 6	6	Regulator ground
EN	1	8	Driving the enable pin (EN) high turns on the regulator. Driving this pin low puts the regulator into shutdown mode. EN can be connected to IN if not used.
NR	5	5	Noise-reduction pin for fixed versions only. Connecting an external capacitor to this pin bypasses noise generated by the internal bandgap, which improves power-supply rejection and reduces output noise. <b>(Not available on adjustable versions.)</b>
FB	5	5	Feedback input voltage for the adjustable device. <b>(Not available on fixed voltage versions.)</b>
OUT	4	3, 4	Regulator output.
NC	–	7	Not connected

**TYPICAL CHARACTERISTICS**

**TPS79530  
OUTPUT VOLTAGE  
vs  
OUTPUT CURRENT**



**Figure 1.**

**TPS79530  
OUTPUT VOLTAGE  
vs  
JUNCTION TEMPERATURE**

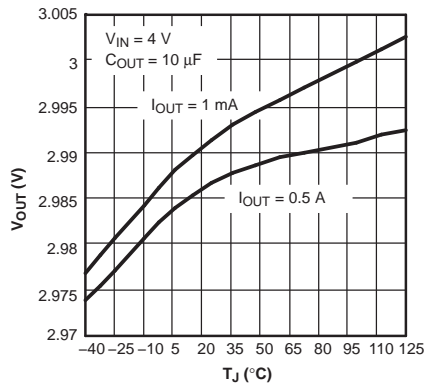

**Figure 2.**

**TPS79530  
GROUND CURRENT  
vs  
JUNCTION TEMPERATURE**

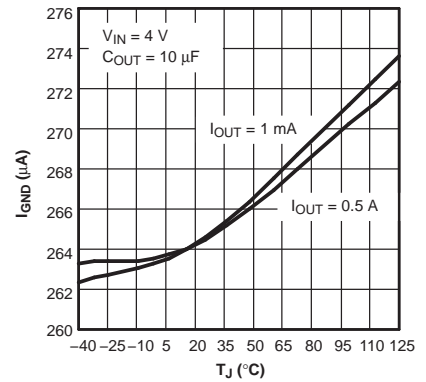

**Figure 3.**

**TPS79530  
OUTPUT SPECTRAL  
NOISE DENSITY  
vs  
FREQUENCY**

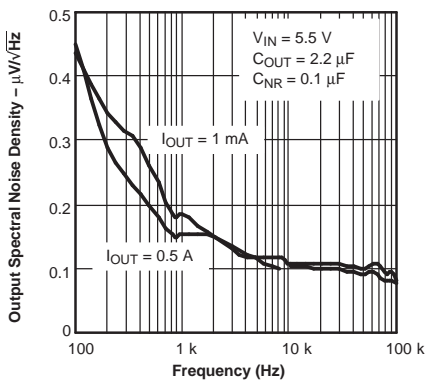

**Figure 4.**

**TPS79530  
OUTPUT SPECTRAL  
NOISE DENSITY  
vs  
FREQUENCY**

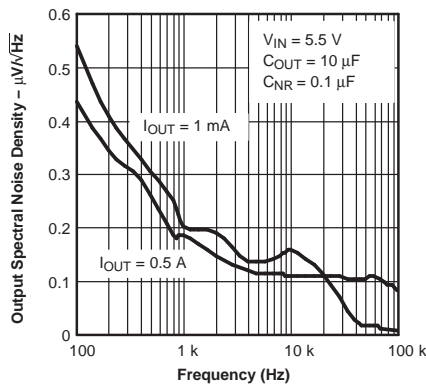

**Figure 5.**

**TPS79530  
OUTPUT SPECTRAL  
NOISE DENSITY  
vs  
FREQUENCY**

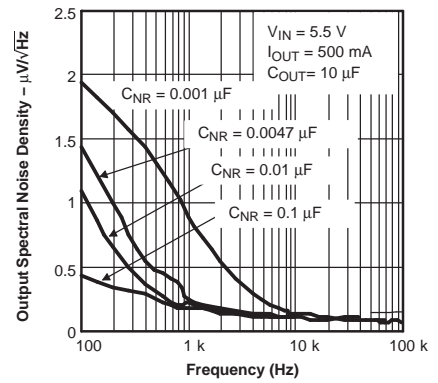

**Figure 6.**

TYPICAL CHARACTERISTICS (continued)

**TPS79530  
ROOT MEAN SQUARED  
OUTPUT NOISE  
VS  
C<sub>NR</sub>**

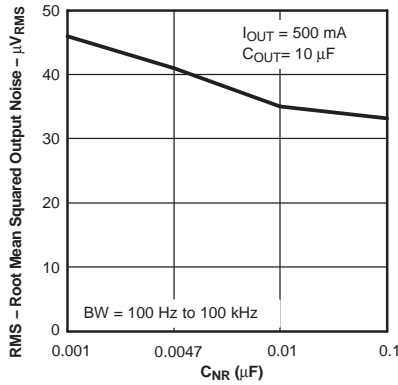

Figure 7.

**TPS79530  
DROPOUT VOLTAGE  
VS  
JUNCTION TEMPERATURE**

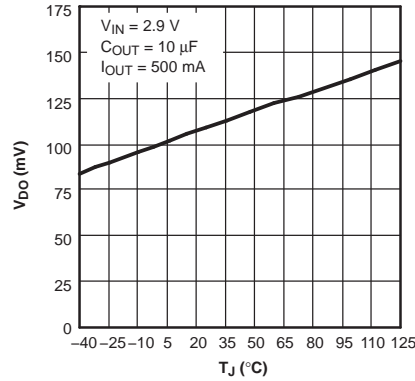

Figure 8.

**TPS79530  
RIPPLE REJECTION  
VS  
FREQUENCY**

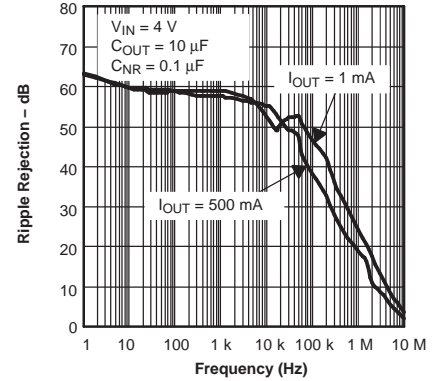

Figure 9.

**TPS79530  
RIPPLE REJECTION  
VS  
FREQUENCY**

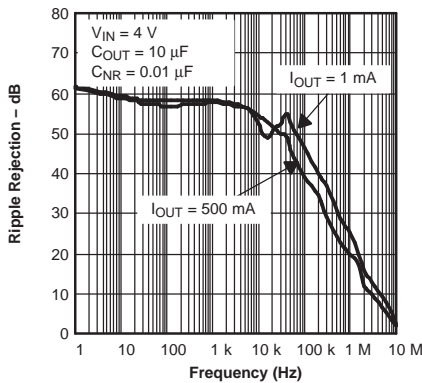

Figure 10.

**TPS79530  
RIPPLE REJECTION  
VS  
FREQUENCY**

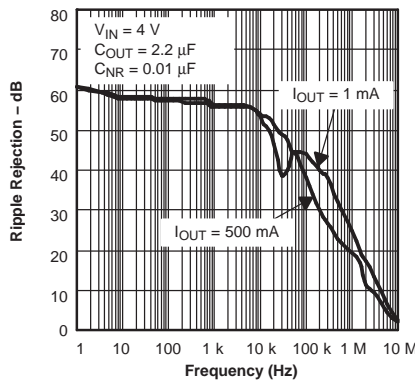

Figure 11.

**TPS79530  
RIPPLE REJECTION  
VS  
FREQUENCY**

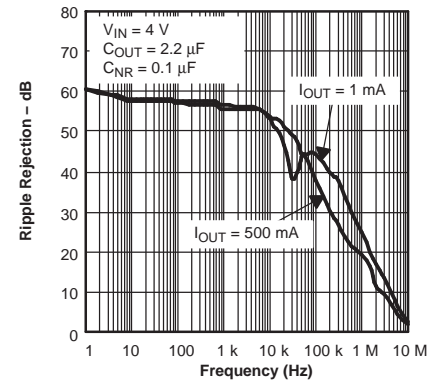

Figure 12.

**TPS79530  
START-UP TIME**

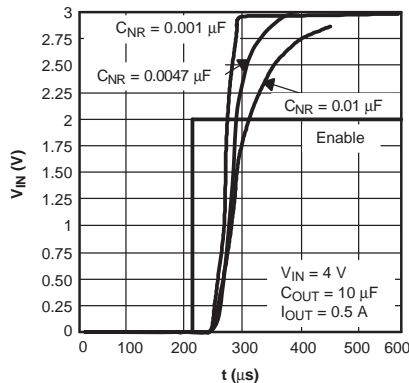

Figure 13.

**TPS79518  
LINE TRANSIENT RESPONSE**

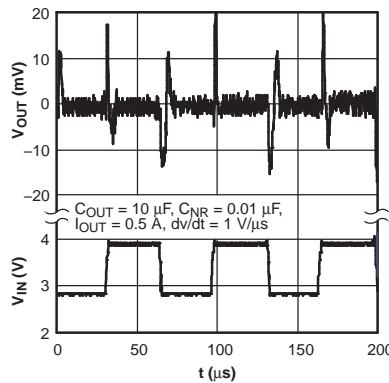

Figure 14.

**TPS79530  
LINE TRANSIENT RESPONSE**

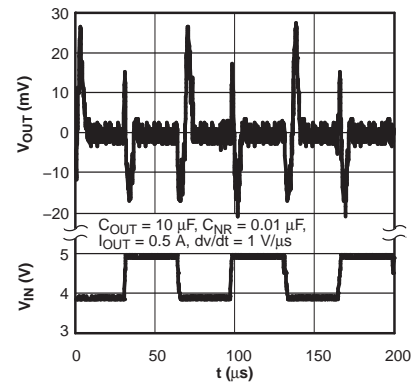

Figure 15.

**TYPICAL CHARACTERISTICS (continued)**

**TPS79530  
LOAD TRANSIENT RESPONSE**

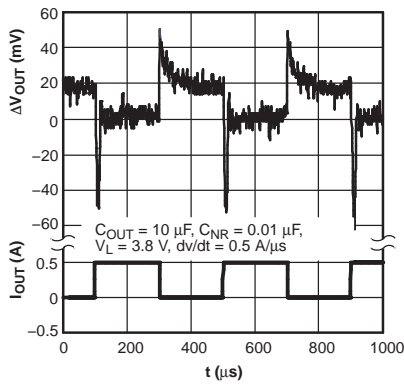

Figure 16.

**TPS79525  
POWER UP/POWER DOWN**

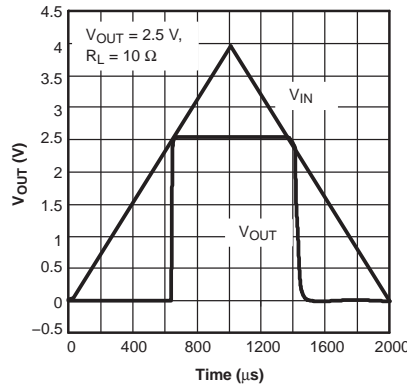

Figure 17.

**TPS79530  
DROPOUT VOLTAGE  
vs  
OUTPUT CURRENT**

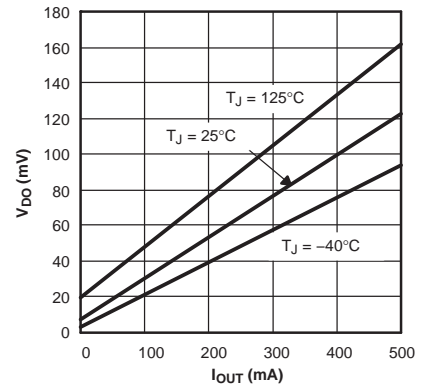

Figure 18.

**TPS79501  
DROPOUT VOLTAGE  
vs  
INPUT VOLTAGE**

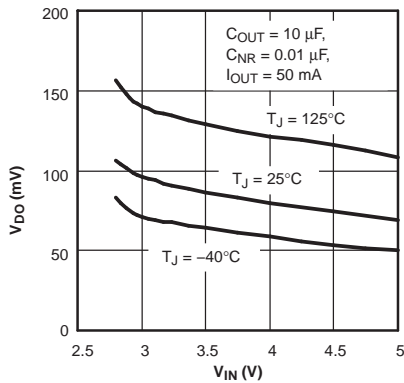

Figure 19.

**TPS79530  
TYPICAL REGIONS OF STABILITY  
EQUIVALENT SERIES RESISTANCE  
(ESR)  
vs  
OUTPUT CURRENT**

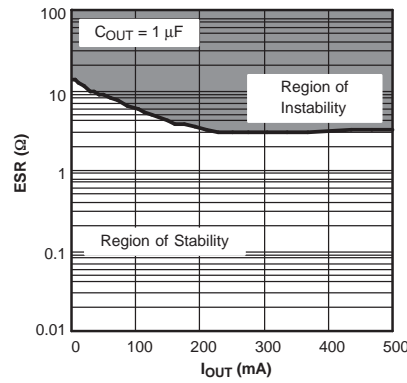

Figure 20.

**TPS79530  
TYPICAL REGIONS OF STABILITY  
EQUIVALENT SERIES RESISTANCE  
(ESR)  
vs  
OUTPUT CURRENT**

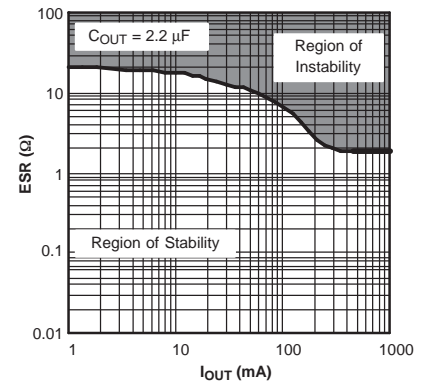

Figure 21.

**TPS79530  
TYPICAL REGIONS OF STABILITY  
EQUIVALENT SERIES RESISTANCE (ESR)  
vs  
OUTPUT CURRENT**

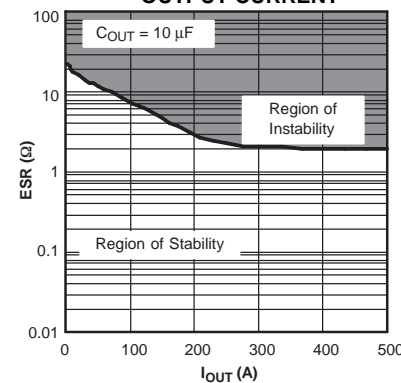

Figure 22.



## APPLICATION INFORMATION

The TPS795xx family of low-dropout (LDO) regulators has been optimized for use in noise-sensitive equipment. The device features extremely low dropout voltages, high PSRR, ultralow output noise, low quiescent current (265  $\mu\text{A}$  typical), and an enable input to reduce supply currents to less than 1  $\mu\text{A}$  when the regulator is turned off.

A typical application circuit is shown in [Figure 23](#).

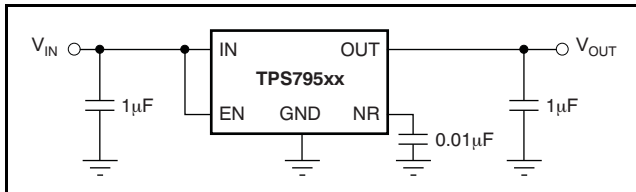

**Figure 23. Typical Application Circuit**

### EXTERNAL CAPACITOR REQUIREMENTS

Although not required, it is good analog design practice to place a 0.1 $\mu\text{F}$  to 2.2 $\mu\text{F}$  capacitor near the input of the regulator to counteract reactive input sources. A higher-value input capacitor may be necessary if large, fast-rise-time load transients are anticipated and the device is located several inches from the power source.

Like most low-dropout regulators, the TPS795xx requires an output capacitor connected between OUT and GND to stabilize the internal control loop. The minimum recommended capacitor is 1  $\mu\text{F}$ . Any 1  $\mu\text{F}$  or larger ceramic capacitor is suitable.

The internal voltage reference is a key source of noise in an LDO regulator. The TPS795xx has an NR pin which is connected to the voltage reference through a 250-k $\Omega$  internal resistor. The 250-k $\Omega$  internal resistor, in conjunction with an external bypass capacitor connected to the NR pin, creates a low-pass filter to reduce the voltage reference noise and, therefore, the noise at the regulator output. In

order for the regulator to operate properly, the current flow out of the NR pin must be at a minimum, because any leakage current creates an IR drop across the internal resistor, thus creating an output error. Therefore, the bypass capacitor must have minimal leakage current. The bypass capacitor should be no more than 0.1- $\mu\text{F}$  in order to ensure that it is fully charged during the quickstart time provided by the internal switch shown in the [Functional Block Diagram](#).

For example, the TPS79530 exhibits only 33  $\mu\text{V}_{\text{RMS}}$  of output voltage noise using a 0.1- $\mu\text{F}$  ceramic bypass capacitor and a 10- $\mu\text{F}$  ceramic output capacitor. Note that the output starts up slower as the bypass capacitance increases because of the RC time constant at the bypass pin that is created by the internal 250-k $\Omega$  resistor and external capacitor.

### BOARD LAYOUT RECOMMENDATION TO IMPROVE PSRR AND NOISE PERFORMANCE

To improve ac measurements such as PSRR, output noise, and transient response, it is recommended that the board be designed with separate ground planes for  $V_{\text{IN}}$  and  $V_{\text{OUT}}$ , with each ground plane connected only at the ground pin of the device. In addition, the ground connection for the bypass capacitor should connect directly to the ground pin of the device.

### REGULATOR MOUNTING

The tab of the SOT223-6 package is electrically connected to ground. For best thermal performance, the tab of the surface-mount version should be soldered directly to a circuit-board copper area. Increasing the copper area improves heat dissipation.

Solder pad footprint recommendations for the devices are presented in application report [SBFA015, Solder Pad Recommendations for Surface-Mount Devices](#), available from the TI web site ([www.ti.com](http://www.ti.com)).

## PROGRAMMING THE TPS79501 ADJUSTABLE LDO REGULATOR

The output voltage of the TPS79501 adjustable regulator is programmed using an external resistor divider as shown in [Figure 24](#). The output voltage is calculated using [Equation 1](#):

$$V_{\text{OUT}} = V_{\text{REF}} \times \left( 1 + \frac{R_1}{R_2} \right) \quad (1)$$

where:

- $V_{\text{REF}} = 1.2246 \text{ V}$  typ (the internal reference voltage)

Resistors  $R_1$  and  $R_2$  should be chosen for approximately 40- $\mu\text{A}$  divider current. Lower value resistors can be used for improved noise performance, but the device wastes more power. Higher values should be avoided, as leakage current at FB increases the output voltage error.

The recommended design procedure is to choose  $R_2 = 30.1 \text{ k}\Omega$  to set the divider current at 40  $\mu\text{A}$ ,  $C_1 = 15 \text{ pF}$  for stability, and then calculate  $R_1$  using [Equation 2](#):

$$R_1 = \left( \frac{V_{\text{OUT}}}{V_{\text{REF}}} - 1 \right) \times R_2 \quad (2)$$

In order to improve the stability of the adjustable version, it is suggested that a small compensation capacitor be placed between OUT and FB.

The approximate value of this capacitor can be calculated as [Equation 3](#):

$$C_1 = \frac{(3 \times 10^{-7}) \times (R_1 + R_2)}{(R_1 \times R_2)} \quad (3)$$

The suggested value of this capacitor for several resistor ratios is shown in the table within [Figure 24](#). If this capacitor is not used (such as in a unity-gain configuration), then the minimum recommended output capacitor is 2.2  $\mu\text{F}$  instead of 1  $\mu\text{F}$ .

## REGULATOR PROTECTION

The TPS795xx PMOS-pass transistor has a built-in back diode that conducts reverse current when the input voltage drops below the output voltage (for example, during power down). Current is conducted from the output to the input and is not internally limited. If extended reverse voltage operation is anticipated, external limiting might be appropriate.

The TPS795xx features internal current limiting and thermal protection. During normal operation, the TPS795xx limits output current to approximately 2.8 A. When current limiting engages, the output voltage scales back linearly until the overcurrent condition ends. While current limiting is designed to prevent gross device failure, care should be taken not to exceed the power dissipation ratings of the package. If the temperature of the device exceeds approximately +165°C, thermal protection circuitry shuts it down. Once the device has cooled down to below approximately +140°C, regulator operation resumes.

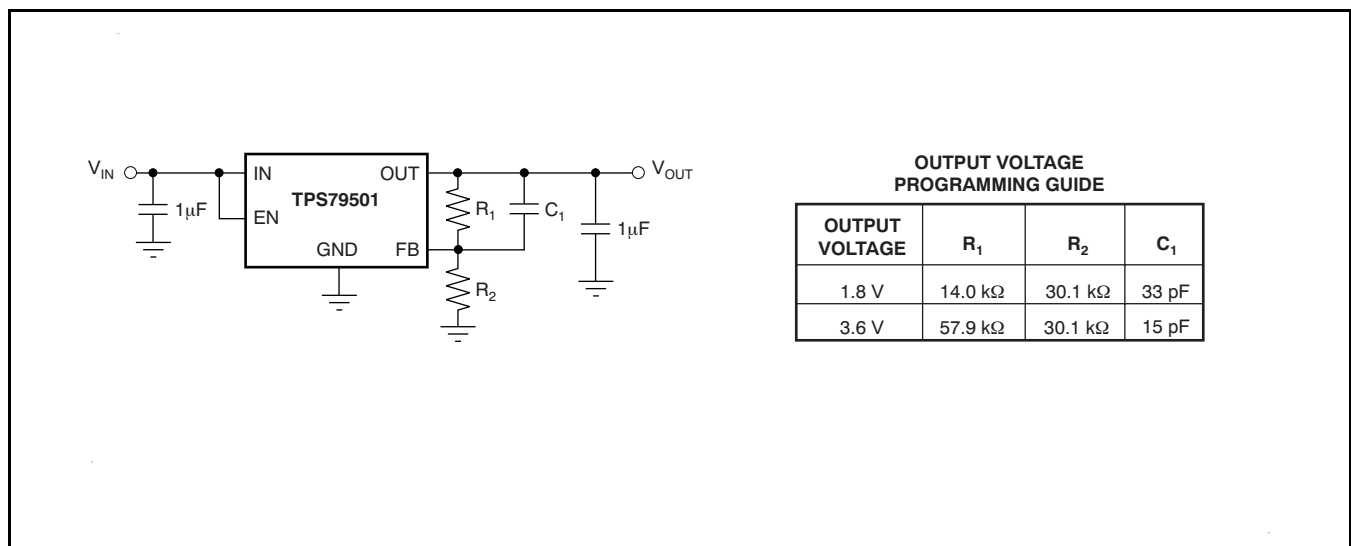

**Figure 24. TPS79501 Adjustable LDO Regulator Programming**

## THERMAL INFORMATION

### Power Dissipation

Knowing the device power dissipation and proper sizing of the thermal plane that is connected to the tab or pad is critical to avoiding thermal shutdown and ensuring reliable operation.

Power dissipation of the device depends on input voltage and load conditions and can be calculated using Equation 4:

$$P_D = (V_{IN} - V_{OUT}) \times I_{OUT} \quad (4)$$

Power dissipation can be minimized and greater efficiency can be achieved by using the lowest possible input voltage necessary to achieve the required output voltage regulation.

On the SON (DRB) package, the primary conduction path for heat is through the exposed pad to the printed circuit board (PCB). The pad can be connected to ground or be left floating; however, it should be attached to an appropriate amount of copper PCB area to ensure the device does not overheat. On the SOT-223 (DCQ) package, the primary conduction path for heat is through the tab to the PCB. The tab should be connected to ground. The maximum junction-to-ambient thermal resistance depends on the maximum ambient temperature, maximum device junction temperature, and power dissipation of the device and can be calculated using Equation 5:

$$R_{\theta JA} = \frac{(+125^{\circ}\text{C} - T_A)}{P_D} \quad (5)$$

Knowing the maximum  $R_{\theta JA}$ , the minimum amount of PCB copper area needed for appropriate heatsinking can be estimated using Figure 25.

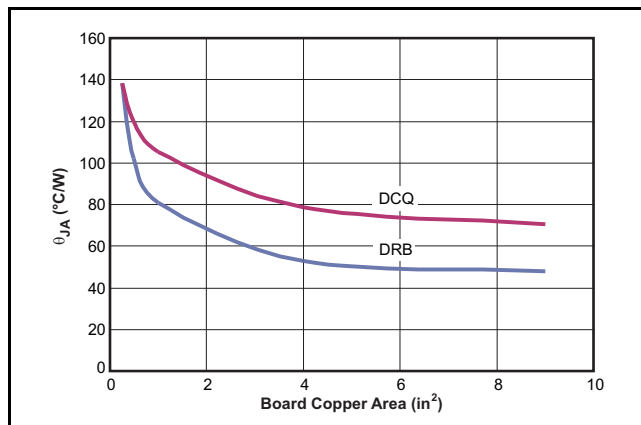

Note:  $\theta_{JA}$  value at board size of 9 in<sup>2</sup> (that is, 3 in × 3 in) is a JEDEC standard.

Figure 25.  $\theta_{JA}$  vs Board Size

Figure 25 shows the variation of  $\theta_{JA}$  as a function of ground plane copper area in the board. It is intended only as a guideline to demonstrate the effect of heat spreading in the ground plane and should not be used to estimate the thermal performance in real application environments.

**NOTE:** When the device is mounted on an application PCB, it is strongly recommended to use  $\Psi_{JT}$  and  $\Psi_{JB}$ , as explained in the [Estimating Junction Temperature](#) section.

### ESTIMATING JUNCTION TEMPERATURE

Using the thermal metrics  $\Psi_{JT}$  and  $\Psi_{JB}$ , as shown in the [Thermal Information](#) table, the junction temperature can be estimated with corresponding formulas (given in Equation 6). For backwards compatibility, an older  $\theta_{JC, Top}$  parameter is also listed.

$$\Psi_{JT}: T_J = T_T + \Psi_{JT} \cdot P_D$$

$$\Psi_{JB}: T_J = T_B + \Psi_{JB} \cdot P_D \quad (6)$$

Where  $P_D$  is the power dissipation shown by Equation 5,  $T_T$  is the temperature at the center-top of the IC package, and  $T_B$  is the PCB temperature measured 1 mm away from the IC package on the PCB surface (as Figure 27 shows).

**NOTE:** Both  $T_T$  and  $T_B$  can be measured on actual application boards using a thermo-gun (an infrared thermometer).

For more information about measuring  $T_T$  and  $T_B$ , see the application note [SBVA025, Using New Thermal Metrics](#), available for download at [www.ti.com](http://www.ti.com).

By looking at Figure 26, the new thermal metrics ( $\Psi_{JT}$  and  $\Psi_{JB}$ ) have little dependency on board size. That is, using  $\Psi_{JT}$  or  $\Psi_{JB}$  with Equation 6 is a good way to estimate  $T_J$  by simply measuring  $T_T$  or  $T_B$ , regardless of the application board size.

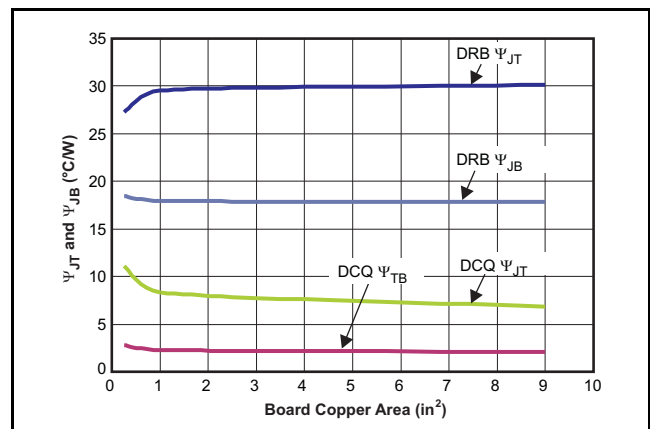

Figure 26.  $\Psi_{JT}$  and  $\Psi_{JB}$  vs Board Size

For a more detailed discussion of why TI does not recommend using  $\theta_{JC(top)}$  to determine thermal characteristics, see the application report [SBVA025](#), *Using New Thermal Metrics*, available for download at [www.ti.com](http://www.ti.com).

For further information, see the application report [SPRA953](#), *IC Package Thermal Metrics*, also available on the TI website.

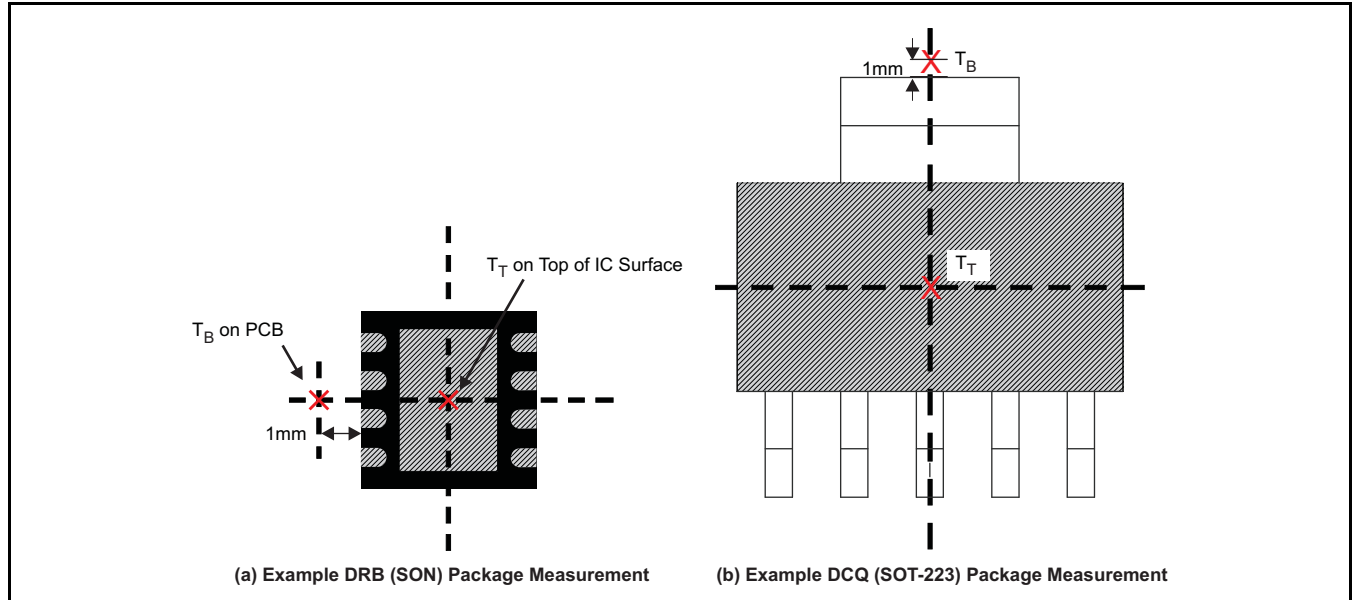

Figure 27. Measuring Point for  $T_T$  and  $T_B$

### REVISION HISTORY

NOTE: Page numbers for previous revisions may differ from page numbers in the current version.

Changes from Revision G (July, 2006) to Revision H	Page
• Replaced the <i>Dissipation Ratings</i> table with the <i>Thermal Information</i> Table .....	3
• Updated the <i>Thermal Information</i> section .....	11

**PACKAGING INFORMATION**

Orderable Device	Status (1)	Package Type	Package Drawing	Pins	Package Qty	Eco Plan (2)	Lead/Ball Finish	MSL Peak Temp (3)	Op Temp (°C)	Top-Side Markings (4)	Samples
TPS79501DCQ	ACTIVE	SOT-223	DCQ	6	78	Green (RoHS & no Sb/Br)	CU SN	Level-2-260C-1 YEAR		PS79501	<a href="#">Samples</a>
TPS79501DCQG4	ACTIVE	SOT-223	DCQ	6	78	TBD	Call TI	Call TI			<a href="#">Samples</a>
TPS79501DCQR	ACTIVE	SOT-223	DCQ	6	2500	Green (RoHS & no Sb/Br)	CU SN	Level-2-260C-1 YEAR		PS79501	<a href="#">Samples</a>
TPS79501DCQRG4	ACTIVE	SOT-223	DCQ	6		TBD	Call TI	Call TI			<a href="#">Samples</a>
TPS79501DRBR	ACTIVE	SON	DRB	8	3000	Green (RoHS & no Sb/Br)	CU NIPDAU	Level-2-260C-1 YEAR		BUH	<a href="#">Samples</a>
TPS79501DRBRG4	ACTIVE	SON	DRB	8	3000	Green (RoHS & no Sb/Br)	CU NIPDAU	Level-2-260C-1 YEAR		BUH	<a href="#">Samples</a>
TPS79501DRBT	ACTIVE	SON	DRB	8	250	Green (RoHS & no Sb/Br)	CU NIPDAU	Level-2-260C-1 YEAR		BUH	<a href="#">Samples</a>
TPS79501DRBTG4	ACTIVE	SON	DRB	8	250	Green (RoHS & no Sb/Br)	CU NIPDAU	Level-2-260C-1 YEAR		BUH	<a href="#">Samples</a>
TPS79516DCQ	ACTIVE	SOT-223	DCQ	6	78	Green (RoHS & no Sb/Br)	CU NIPDAU	Level-2-260C-1 YEAR		PS79516	<a href="#">Samples</a>
TPS79516DCQG4	ACTIVE	SOT-223	DCQ	6	78	Green (RoHS & no Sb/Br)	CU NIPDAU	Level-2-260C-1 YEAR		PS79516	<a href="#">Samples</a>
TPS79516DCQR	ACTIVE	SOT-223	DCQ	6	2500	Green (RoHS & no Sb/Br)	CU NIPDAU	Level-2-260C-1 YEAR		PS79516	<a href="#">Samples</a>
TPS79516DCQRG4	ACTIVE	SOT-223	DCQ	6	2500	Green (RoHS & no Sb/Br)	CU NIPDAU	Level-2-260C-1 YEAR		PS79516	<a href="#">Samples</a>
TPS79518DCQ	ACTIVE	SOT-223	DCQ	6	78	Green (RoHS & no Sb/Br)	CU NIPDAU	Level-2-260C-1 YEAR		PS79518	<a href="#">Samples</a>
TPS79518DCQG4	ACTIVE	SOT-223	DCQ	6	78	Green (RoHS & no Sb/Br)	CU NIPDAU	Level-2-260C-1 YEAR		PS79518	<a href="#">Samples</a>
TPS79518DCQR	ACTIVE	SOT-223	DCQ	6	2500	Green (RoHS & no Sb/Br)	CU NIPDAU	Level-2-260C-1 YEAR	-40 to 125	PS79518	<a href="#">Samples</a>
TPS79518DCQRG4	ACTIVE	SOT-223	DCQ	6	2500	Green (RoHS & no Sb/Br)	CU NIPDAU	Level-2-260C-1 YEAR	-40 to 125	PS79518	<a href="#">Samples</a>
TPS79525DCQ	ACTIVE	SOT-223	DCQ	6	78	Green (RoHS & no Sb/Br)	CU NIPDAU	Level-2-260C-1 YEAR	-40 to 125	PS79525	<a href="#">Samples</a>

Orderable Device	Status (1)	Package Type	Package Drawing	Pins	Package Qty	Eco Plan (2)	Lead/Ball Finish	MSL Peak Temp (3)	Op Temp (°C)	Top-Side Markings (4)	Samples
TPS79525DCQG4	ACTIVE	SOT-223	DCQ	6	78	Green (RoHS & no Sb/Br)	CU NIPDAU	Level-2-260C-1 YEAR	-40 to 125	PS79525	<a href="#">Samples</a>
TPS79525DCQR	ACTIVE	SOT-223	DCQ	6	2500	Green (RoHS & no Sb/Br)	CU NIPDAU	Level-2-260C-1 YEAR	-40 to 125	PS79525	<a href="#">Samples</a>
TPS79525DCQRG4	ACTIVE	SOT-223	DCQ	6	2500	Green (RoHS & no Sb/Br)	CU NIPDAU	Level-2-260C-1 YEAR	-40 to 125	PS79525	<a href="#">Samples</a>
TPS79530DCQ	ACTIVE	SOT-223	DCQ	6	78	Green (RoHS & no Sb/Br)	CU NIPDAU	Level-2-260C-1 YEAR		PS79530	<a href="#">Samples</a>
TPS79530DCQG4	ACTIVE	SOT-223	DCQ	6	78	Green (RoHS & no Sb/Br)	CU NIPDAU	Level-2-260C-1 YEAR		PS79530	<a href="#">Samples</a>
TPS79530DCQR	ACTIVE	SOT-223	DCQ	6	2500	Green (RoHS & no Sb/Br)	CU NIPDAU	Level-2-260C-1 YEAR		PS79530	<a href="#">Samples</a>
TPS79530DCQRG4	ACTIVE	SOT-223	DCQ	6	2500	Green (RoHS & no Sb/Br)	CU NIPDAU	Level-2-260C-1 YEAR		PS79530	<a href="#">Samples</a>
TPS79533DCQ	ACTIVE	SOT-223	DCQ	6	78	Green (RoHS & no Sb/Br)	CU SN	Level-2-260C-1 YEAR		PS79533	<a href="#">Samples</a>
TPS79533DCQG4	ACTIVE	SOT-223	DCQ	6	78	TBD	Call TI	Call TI			<a href="#">Samples</a>
TPS79533DCQR	ACTIVE	SOT-223	DCQ	6	2500	Green (RoHS & no Sb/Br)	CU SN	Level-2-260C-1 YEAR		PS79533	<a href="#">Samples</a>
TPS79533DCQRG4	ACTIVE	SOT-223	DCQ	6	2500	TBD	Call TI	Call TI			<a href="#">Samples</a>

(1) The marketing status values are defined as follows:

**ACTIVE:** Product device recommended for new designs.

**LIFEBUY:** TI has announced that the device will be discontinued, and a lifetime-buy period is in effect.

**NRND:** Not recommended for new designs. Device is in production to support existing customers, but TI does not recommend using this part in a new design.

**PREVIEW:** Device has been announced but is not in production. Samples may or may not be available.

**OBSOLETE:** TI has discontinued the production of the device.

(2) Eco Plan - The planned eco-friendly classification: Pb-Free (RoHS), Pb-Free (RoHS Exempt), or Green (RoHS & no Sb/Br) - please check <http://www.ti.com/productcontent> for the latest availability information and additional product content details.

**TBD:** The Pb-Free/Green conversion plan has not been defined.

**Pb-Free (RoHS):** TI's terms "Lead-Free" or "Pb-Free" mean semiconductor products that are compatible with the current RoHS requirements for all 6 substances, including the requirement that lead not exceed 0.1% by weight in homogeneous materials. Where designed to be soldered at high temperatures, TI Pb-Free products are suitable for use in specified lead-free processes.

**Pb-Free (RoHS Exempt):** This component has a RoHS exemption for either 1) lead-based flip-chip solder bumps used between the die and package, or 2) lead-based die adhesive used between the die and leadframe. The component is otherwise considered Pb-Free (RoHS compatible) as defined above.

**Green (RoHS & no Sb/Br):** TI defines "Green" to mean Pb-Free (RoHS compatible), and free of Bromine (Br) and Antimony (Sb) based flame retardants (Br or Sb do not exceed 0.1% by weight in homogeneous material)

<sup>(3)</sup> MSL, Peak Temp. -- The Moisture Sensitivity Level rating according to the JEDEC industry standard classifications, and peak solder temperature.

<sup>(4)</sup> Only one of markings shown within the brackets will appear on the physical device.

**Important Information and Disclaimer:** The information provided on this page represents TI's knowledge and belief as of the date that it is provided. TI bases its knowledge and belief on information provided by third parties, and makes no representation or warranty as to the accuracy of such information. Efforts are underway to better integrate information from third parties. TI has taken and continues to take reasonable steps to provide representative and accurate information but may not have conducted destructive testing or chemical analysis on incoming materials and chemicals. TI and TI suppliers consider certain information to be proprietary, and thus CAS numbers and other limited information may not be available for release.

In no event shall TI's liability arising out of such information exceed the total purchase price of the TI part(s) at issue in this document sold by TI to Customer on an annual basis.

**OTHER QUALIFIED VERSIONS OF TPS79501 :**

- Automotive: [TPS79501-Q1](#)

**NOTE: Qualified Version Definitions:**

- Automotive - Q100 devices qualified for high-reliability automotive applications targeting zero defects

**TAPE AND REEL INFORMATION**

**QUADRANT ASSIGNMENTS FOR PIN 1 ORIENTATION IN TAPE**

\*All dimensions are nominal

Device	Package Type	Package Drawing	Pins	SPQ	Reel Diameter (mm)	Reel Width W1 (mm)	A0 (mm)	B0 (mm)	K0 (mm)	P1 (mm)	W (mm)	Pin1 Quadrant
TPS79501DCQR	SOT-223	DCQ	6	2500	330.0	12.4	6.8	7.3	1.88	8.0	12.0	Q3
TPS79501DRBR	SON	DRB	8	3000	330.0	12.4	3.3	3.3	1.1	8.0	12.0	Q2
TPS79501DRBT	SON	DRB	8	250	180.0	12.4	3.3	3.3	1.1	8.0	12.0	Q2
TPS79516DCQR	SOT-223	DCQ	6	2500	330.0	12.4	6.8	7.3	1.88	8.0	12.0	Q3
TPS79518DCQR	SOT-223	DCQ	6	2500	330.0	12.4	6.8	7.3	1.88	8.0	12.0	Q3
TPS79525DCQR	SOT-223	DCQ	6	2500	330.0	12.4	6.8	7.3	1.88	8.0	12.0	Q3
TPS79530DCQR	SOT-223	DCQ	6	2500	330.0	12.4	6.8	7.3	1.88	8.0	12.0	Q3
TPS79533DCQR	SOT-223	DCQ	6	2500	330.0	12.4	6.8	7.3	1.88	8.0	12.0	Q3



**TAPE AND REEL BOX DIMENSIONS**

\*All dimensions are nominal

Device	Package Type	Package Drawing	Pins	SPQ	Length (mm)	Width (mm)	Height (mm)
TPS79501DCQR	SOT-223	DCQ	6	2500	358.0	335.0	35.0
TPS79501DRBR	SON	DRB	8	3000	367.0	367.0	35.0
TPS79501DRBT	SON	DRB	8	250	210.0	185.0	35.0
TPS79516DCQR	SOT-223	DCQ	6	2500	358.0	335.0	35.0
TPS79518DCQR	SOT-223	DCQ	6	2500	358.0	335.0	35.0
TPS79525DCQR	SOT-223	DCQ	6	2500	358.0	335.0	35.0
TPS79530DCQR	SOT-223	DCQ	6	2500	358.0	335.0	35.0
TPS79533DCQR	SOT-223	DCQ	6	2500	358.0	335.0	35.0

DCQ (R-PDSO-G6)

PLASTIC SMALL-OUTLINE

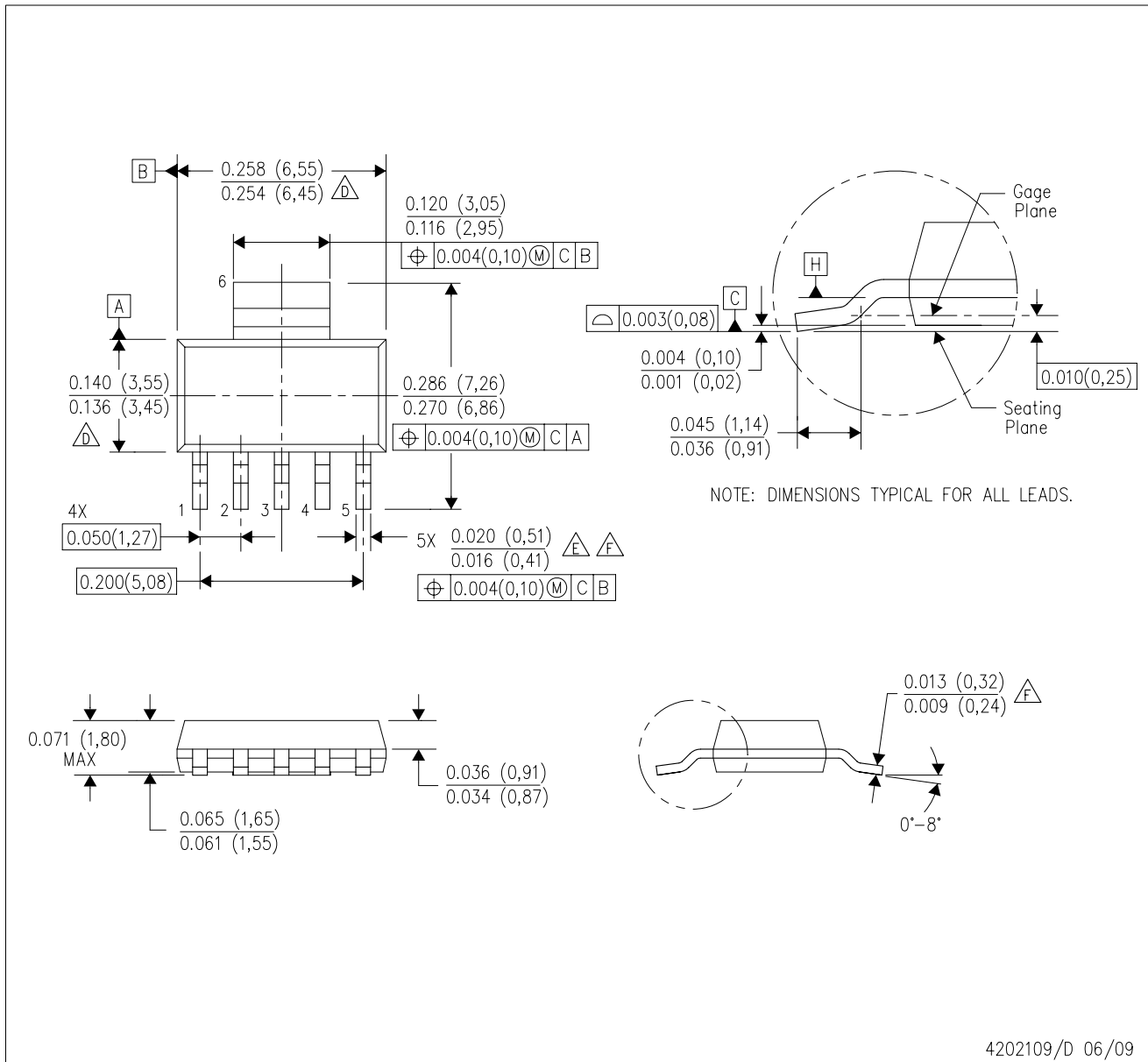

4202109/D 06/09

- NOTES:
- A. All linear dimensions are in inches (millimeters).
  - B. This drawing is subject to change without notice.
  - C. Controlling dimension in inches.
  - $\triangle D$  Body length and width dimensions are determined at the outermost extremes of the plastic body exclusive of mold flash, tie bar burrs, gate burrs, and interlead flash, but including any mismatch between the top and the bottom of the plastic body.
  - $\triangle E$  Lead width dimension does not include dambar protrusion.
  - $\triangle F$  Lead width and thickness dimensions apply to solder plated leads.
  - G. Interlead flash allow 0.008 inch max.
  - H. Gate burr/protrusion max. 0.006 inch.
  - I. Datums A and B are to be determined at Datum H.

DCQ (R-PDSO-G6)

PLASTIC SMALL OUTLINE

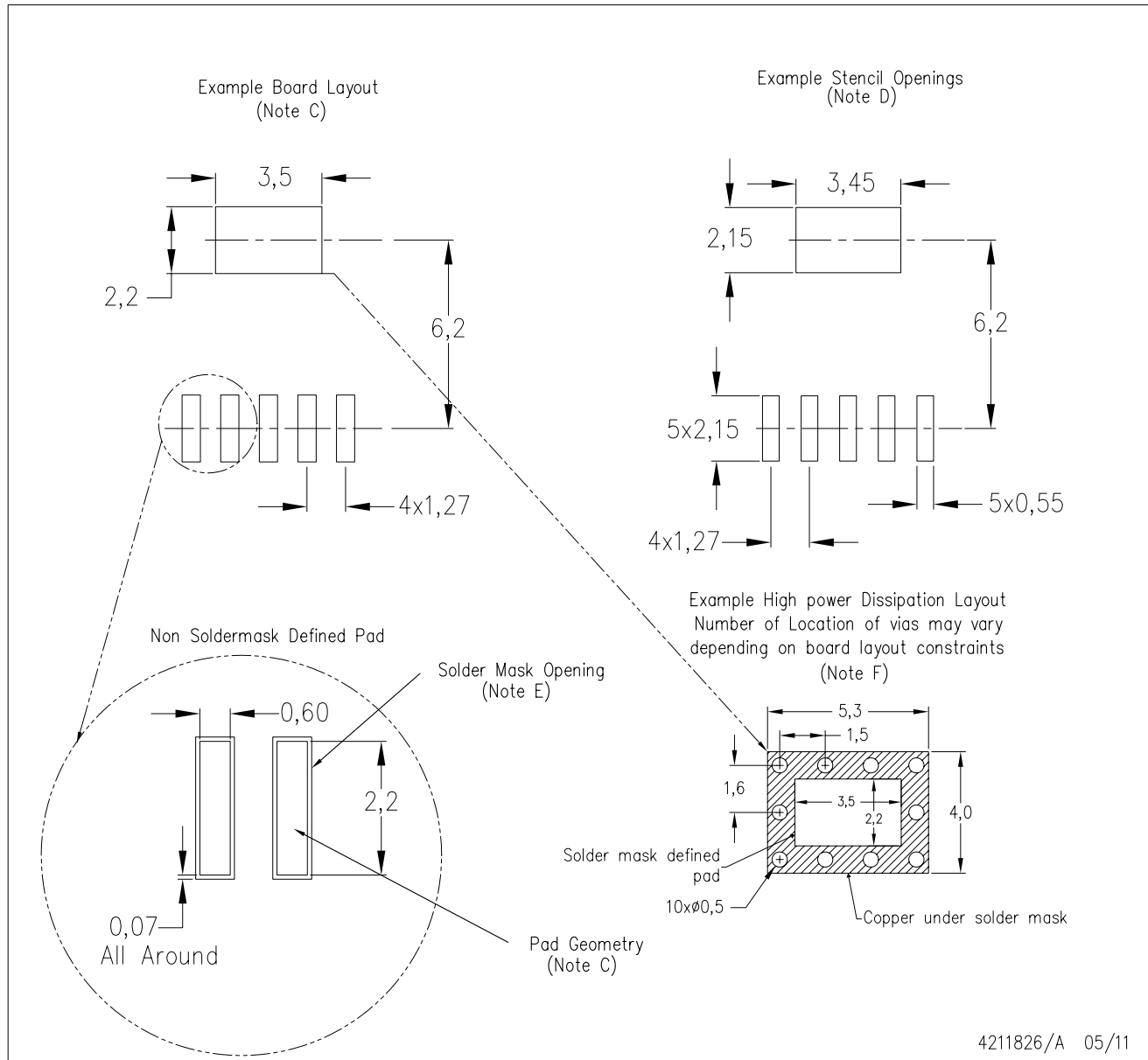

- NOTES:
- All linear dimensions are in millimeters.
  - This drawing is subject to change without notice.
  - Publication IPC-SM-782 is recommended for alternate designs.
  - Laser cutting apertures with trapezoidal walls and also rounding corners will offer better paste release. Customers should contact their board assembly site for stencil design recommendations.
  - Customers should contact their board fabrication site for solder mask tolerances between and around signal pads.
  - Please refer to the product data sheet for specific via and thermal dissipation requirements.

DRB (S-PVSON-N8)

PLASTIC SMALL OUTLINE NO-LEAD



- NOTES:
- All linear dimensions are in millimeters. Dimensioning and tolerancing per ASME Y14.5M-1994.
  - This drawing is subject to change without notice.
  - Small Outline No-Lead (SON) package configuration.
  - The package thermal pad must be soldered to the board for thermal and mechanical performance.
  - See the additional figure in the Product Data Sheet for details regarding the exposed thermal pad features and dimensions.

THERMAL INFORMATION

This package incorporates an exposed thermal pad that is designed to be attached directly to an external heatsink. The thermal pad must be soldered directly to the printed circuit board (PCB). After soldering, the PCB can be used as a heatsink. In addition, through the use of thermal vias, the thermal pad can be attached directly to the appropriate copper plane shown in the electrical schematic for the device, or alternatively, can be attached to a special heatsink structure designed into the PCB. This design optimizes the heat transfer from the integrated circuit (IC).

For information on the Quad Flatpack No-Lead (QFN) package and its advantages, refer to Application Report, QFN/SON PCB Attachment, Texas Instruments Literature No. SLUA271. This document is available at [www.ti.com](http://www.ti.com).

The exposed thermal pad dimensions for this package are shown in the following illustration.

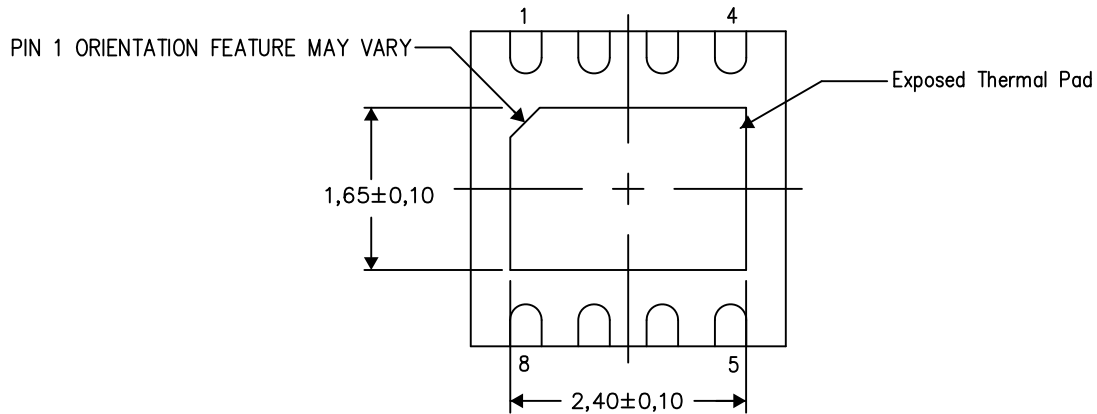

Bottom View

Exposed Thermal Pad Dimensions

4206340-3/N 09/12

NOTE: All linear dimensions are in millimeters

DRB (S-PVSON-N8)

PLASTIC SMALL OUTLINE NO-LEAD

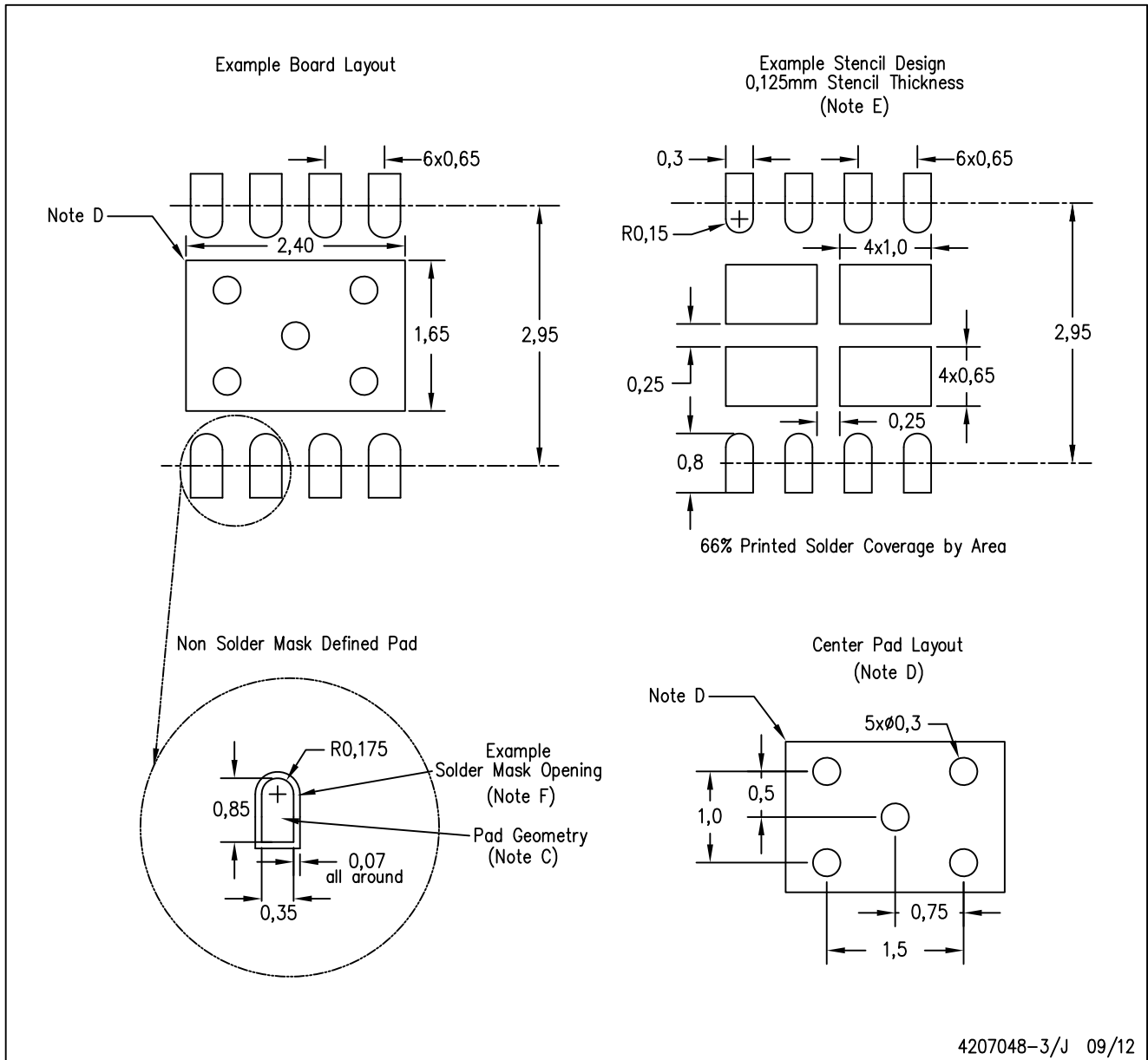

- NOTES:
- A. All linear dimensions are in millimeters.
  - B. This drawing is subject to change without notice.
  - C. Publication IPC-7351 is recommended for alternate designs.
  - D. This package is designed to be soldered to a thermal pad on the board. Refer to Application Note, QFN Packages, Texas Instruments Literature No. SLUA271, and also the Product Data Sheets for specific thermal information, via requirements, and recommended board layout. These documents are available at [www.ti.com](http://www.ti.com) <<http://www.ti.com>>.
  - E. Laser cutting apertures with trapezoidal walls and also rounding corners will offer better paste release. Customers should contact their board assembly site for stencil design recommendations. Refer to IPC 7525 for stencil design considerations.
  - F. Customers should contact their board fabrication site for solder mask tolerances.

## IMPORTANT NOTICE

Texas Instruments Incorporated and its subsidiaries (TI) reserve the right to make corrections, enhancements, improvements and other changes to its semiconductor products and services per JESD46, latest issue, and to discontinue any product or service per JESD48, latest issue. Buyers should obtain the latest relevant information before placing orders and should verify that such information is current and complete. All semiconductor products (also referred to herein as "components") are sold subject to TI's terms and conditions of sale supplied at the time of order acknowledgment.

TI warrants performance of its components to the specifications applicable at the time of sale, in accordance with the warranty in TI's terms and conditions of sale of semiconductor products. Testing and other quality control techniques are used to the extent TI deems necessary to support this warranty. Except where mandated by applicable law, testing of all parameters of each component is not necessarily performed.

TI assumes no liability for applications assistance or the design of Buyers' products. Buyers are responsible for their products and applications using TI components. To minimize the risks associated with Buyers' products and applications, Buyers should provide adequate design and operating safeguards.

TI does not warrant or represent that any license, either express or implied, is granted under any patent right, copyright, mask work right, or other intellectual property right relating to any combination, machine, or process in which TI components or services are used. Information published by TI regarding third-party products or services does not constitute a license to use such products or services or a warranty or endorsement thereof. Use of such information may require a license from a third party under the patents or other intellectual property of the third party, or a license from TI under the patents or other intellectual property of TI.

Reproduction of significant portions of TI information in TI data books or data sheets is permissible only if reproduction is without alteration and is accompanied by all associated warranties, conditions, limitations, and notices. TI is not responsible or liable for such altered documentation. Information of third parties may be subject to additional restrictions.

Resale of TI components or services with statements different from or beyond the parameters stated by TI for that component or service voids all express and any implied warranties for the associated TI component or service and is an unfair and deceptive business practice. TI is not responsible or liable for any such statements.

Buyer acknowledges and agrees that it is solely responsible for compliance with all legal, regulatory and safety-related requirements concerning its products, and any use of TI components in its applications, notwithstanding any applications-related information or support that may be provided by TI. Buyer represents and agrees that it has all the necessary expertise to create and implement safeguards which anticipate dangerous consequences of failures, monitor failures and their consequences, lessen the likelihood of failures that might cause harm and take appropriate remedial actions. Buyer will fully indemnify TI and its representatives against any damages arising out of the use of any TI components in safety-critical applications.

In some cases, TI components may be promoted specifically to facilitate safety-related applications. With such components, TI's goal is to help enable customers to design and create their own end-product solutions that meet applicable functional safety standards and requirements. Nonetheless, such components are subject to these terms.

No TI components are authorized for use in FDA Class III (or similar life-critical medical equipment) unless authorized officers of the parties have executed a special agreement specifically governing such use.

Only those TI components which TI has specifically designated as military grade or "enhanced plastic" are designed and intended for use in military/aerospace applications or environments. Buyer acknowledges and agrees that any military or aerospace use of TI components which have **not** been so designated is solely at the Buyer's risk, and that Buyer is solely responsible for compliance with all legal and regulatory requirements in connection with such use.

TI has specifically designated certain components as meeting ISO/TS16949 requirements, mainly for automotive use. In any case of use of non-designated products, TI will not be responsible for any failure to meet ISO/TS16949.

### Products

Audio	<a href="http://www.ti.com/audio">www.ti.com/audio</a>
Amplifiers	<a href="http://amplifier.ti.com">amplifier.ti.com</a>
Data Converters	<a href="http://dataconverter.ti.com">dataconverter.ti.com</a>
DLP® Products	<a href="http://www.dlp.com">www.dlp.com</a>
DSP	<a href="http://dsp.ti.com">dsp.ti.com</a>
Clocks and Timers	<a href="http://www.ti.com/clocks">www.ti.com/clocks</a>
Interface	<a href="http://interface.ti.com">interface.ti.com</a>
Logic	<a href="http://logic.ti.com">logic.ti.com</a>
Power Mgmt	<a href="http://power.ti.com">power.ti.com</a>
Microcontrollers	<a href="http://microcontroller.ti.com">microcontroller.ti.com</a>
RFID	<a href="http://www.ti-rfid.com">www.ti-rfid.com</a>
OMAP Applications Processors	<a href="http://www.ti.com/omap">www.ti.com/omap</a>
Wireless Connectivity	<a href="http://www.ti.com/wirelessconnectivity">www.ti.com/wirelessconnectivity</a>

### Applications

Automotive and Transportation	<a href="http://www.ti.com/automotive">www.ti.com/automotive</a>
Communications and Telecom	<a href="http://www.ti.com/communications">www.ti.com/communications</a>
Computers and Peripherals	<a href="http://www.ti.com/computers">www.ti.com/computers</a>
Consumer Electronics	<a href="http://www.ti.com/consumer-apps">www.ti.com/consumer-apps</a>
Energy and Lighting	<a href="http://www.ti.com/energy">www.ti.com/energy</a>
Industrial	<a href="http://www.ti.com/industrial">www.ti.com/industrial</a>
Medical	<a href="http://www.ti.com/medical">www.ti.com/medical</a>
Security	<a href="http://www.ti.com/security">www.ti.com/security</a>
Space, Avionics and Defense	<a href="http://www.ti.com/space-avionics-defense">www.ti.com/space-avionics-defense</a>
Video and Imaging	<a href="http://www.ti.com/video">www.ti.com/video</a>

### TI E2E Community

[e2e.ti.com](http://e2e.ti.com)