

- Output Swing Includes Both Supply Rails
- Low Noise . . . 15 nV/√Hz Typ at f = 1 kHz
- Low Input Bias Current . . . 1 pA Typ
- Fully Specified for Single-Supply 3-V and 5-V Operation
- Common-Mode Input Voltage Range Includes Negative Rail
- High Gain Bandwidth . . . 2 MHz at $V_{DD} = 5\text{ V}$ With 600-Ω Load
- High Slew Rate . . . 1.6 V/μs at $V_{DD} = 5\text{ V}$
- Wide Supply Voltage Range 2.7 V to 10 V
- Macromodel Included

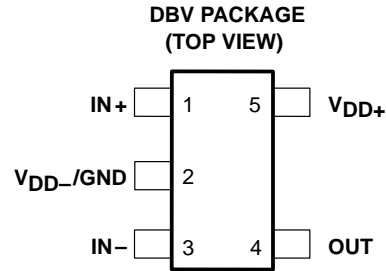

description

The TLV2231 is a single low-voltage operational amplifier available in the SOT-23 package. It offers 2 MHz of bandwidth and 1.6 V/μs of slew rate for applications requiring good ac performance. The device exhibits rail-to-rail output performance for increased dynamic range in single or split supply applications. The TLV2231 is fully characterized at 3 V and 5 V and is optimized for low-voltage applications.

The TLV2231, exhibiting high input impedance and low noise, is excellent for small-signal conditioning of high-impedance sources, such as piezoelectric transducers. Because of the micropower dissipation levels combined with 3-V operation, these devices work well in hand-held monitoring and remote-sensing applications. In addition, the rail-to-rail output feature with single- or split-supplies makes this family a great choice when interfacing with analog-to-digital converters (ADCs). The device can also drive 600-Ω loads for telecom applications.

With a total area of 5.6mm², the SOT-23 package only requires one-third the board space of the standard 8-pin SOIC package. This ultra-small package allows designers to place single amplifiers very close to the signal source, minimizing noise pick-up from long PCB traces. TI has also taken special care to provide a pinout that is optimized for board layout (see Figure 1). Both inputs are separated by GND to prevent coupling or leakage paths. The OUT and IN– terminals are on the same end of the board for providing negative feedback. Finally, gain setting resistors and the decoupling capacitor are easily placed around the package.

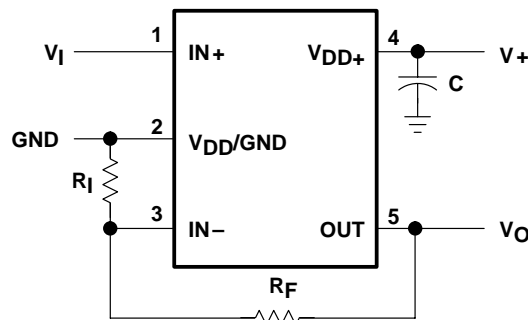

Figure 1. Typical Surface Mount Layout for a Fixed-Gain Noninverting Amplifier



Please be aware that an important notice concerning availability, standard warranty, and use in critical applications of Texas Instruments semiconductor products and disclaimers thereto appears at the end of this data sheet.

Advanced LinCMOS is a trademark of Texas Instruments.

PRODUCTION DATA information is current as of publication date. Products conform to specifications per the terms of Texas Instruments standard warranty. Production processing does not necessarily include testing of all parameters.

**TEXAS
INSTRUMENTS**

POST OFFICE BOX 655303 • DALLAS, TEXAS 75265

Copyright © 2001, Texas Instruments Incorporated

TLV2231, TLV2231Y

Advanced LinCMOS™ RAIL-TO-RAIL

LOW-POWER SINGLE OPERATIONAL AMPLIFIERS

SLOS158D – JUNE 1996 – REVISED APRIL 2001

AVAILABLE OPTIONS

T _A	V _{IO} max AT 25°C	PACKAGED DEVICES	SYMBOL	CHIP FORM‡ (Y)
		SOT-23 (DBV)†		
0°C to 70°C	3 mV	TLV2231CDBV	VAEC	TLV2231Y
-40°C to 85°C	3 mV	TLV2231IDBV	VAEI	

† The DBV package available in tape and reel only.

‡ Chip forms are tested at T_A = 25°C only.

TLV2231Y chip information

This chip, when properly assembled, displays characteristics similar to the TLV2231C. Thermal compression or ultrasonic bonding may be used on the doped-aluminum bonding pads. This chip may be mounted with conductive epoxy or a gold-silicon preform.

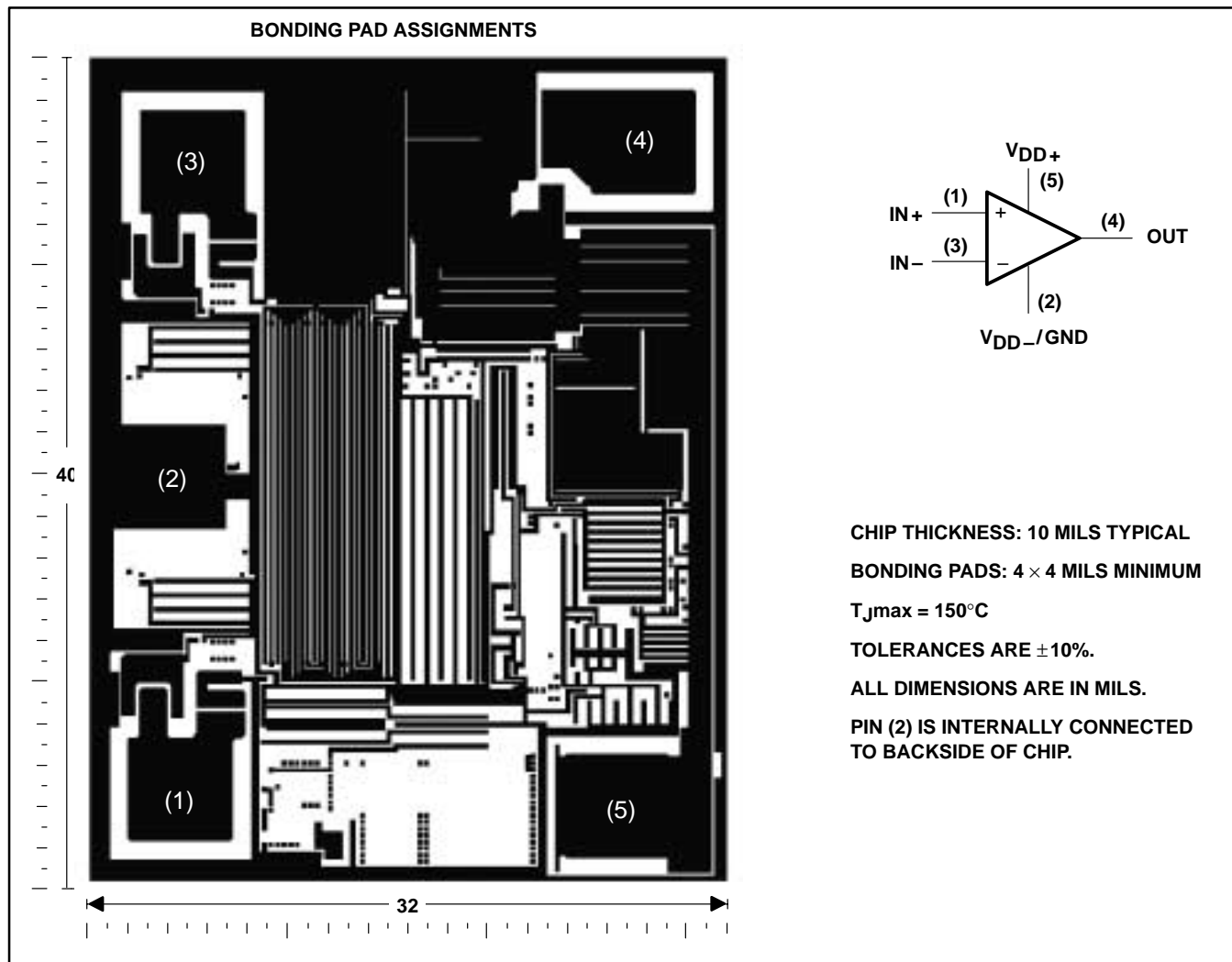

equivalent schematic

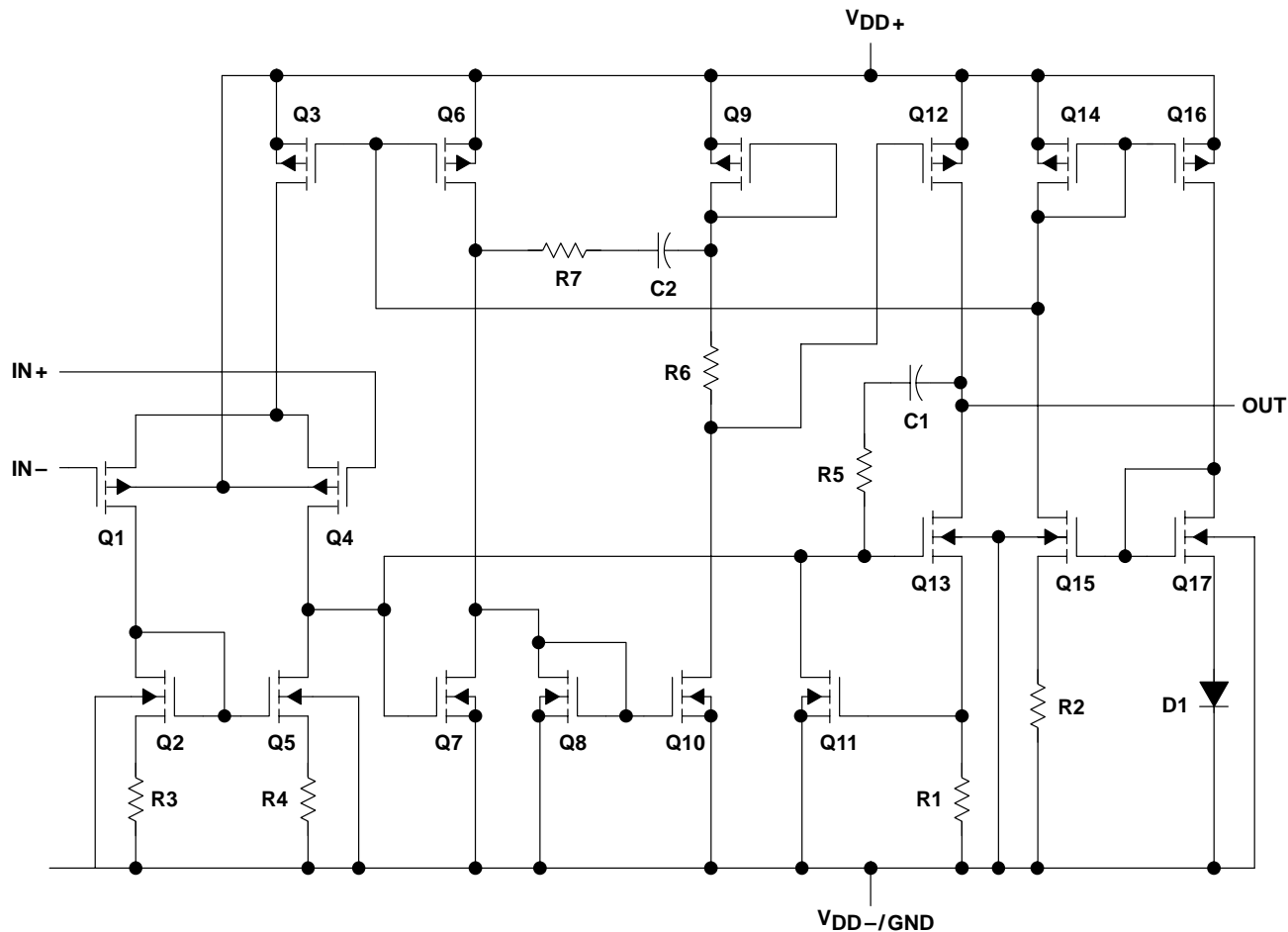

COMPONENT COUNT†	
Transistors	23
Diodes	5
Resistors	11
Capacitors	2

† Includes both amplifiers and all ESD, bias, and trim circuitry

TLV2231, TLV2231Y
Advanced LinCMOS™ RAIL-TO-RAIL
LOW-POWER SINGLE OPERATIONAL AMPLIFIERS

SLOS158D – JUNE 1996 – REVISED APRIL 2001

absolute maximum ratings over operating free-air temperature range (unless otherwise noted)†

Supply voltage, V_{DD} (see Note 1)	12 V
Differential input voltage, V_{ID} (see Note 2)	$\pm V_{DD}$
Input voltage range, V_I (any input, see Note 1)	-0.3 V to V_{DD}
Input current, I_I (each input)	± 5 mA
Output current, I_O	± 50 mA
Total current into V_{DD+}	± 50 mA
Total current out of V_{DD-}	± 50 mA
Duration of short-circuit current (at or below) 25°C (see Note 3)	unlimited
Continuous total power dissipation	See Dissipation Rating Table
Operating free-air temperature range, T_A : TLV2231C	0°C to 70°C
TLV2231I	-40°C to 85°C
Storage temperature range, T_{stg}	-65°C to 150°C
Lead temperature 1,6 mm (1/16 inch) from case for 10 seconds: DBV package	260°C

† Stresses beyond those listed under “absolute maximum ratings” may cause permanent damage to the device. These are stress ratings only, and functional operation of the device at these or any other conditions beyond those indicated under “recommended operating conditions” is not implied. Exposure to absolute-maximum-rated conditions for extended periods may affect device reliability.

- NOTES: 1. All voltage values, except differential voltages, are with respect to V_{DD-} .
 2. Differential voltages are at the noninverting input with respect to the inverting input. Excessive current flows when input is brought below $V_{DD-} - 0.3$ V.
 3. The output may be shorted to either supply. Temperature and/or supply voltages must be limited to ensure that the maximum dissipation rating is not exceeded.

DISSIPATION RATING TABLE

PACKAGE	$T_A \leq 25^\circ\text{C}$ POWER RATING	DERATING FACTOR ABOVE $T_A = 25^\circ\text{C}$	$T_A = 70^\circ\text{C}$ POWER RATING	$T_A = 85^\circ\text{C}$ POWER RATING
DBV	150 mW	1.2 mW/°C	96 mW	78 mW

recommended operating conditions

	TLV2231C		TLV2231I		UNIT
	MIN	MAX	MIN	MAX	
Supply voltage, V_{DD} (see Note 1)	2.7	10	2.7	10	V
Input voltage range, V_I	V_{DD-}	$V_{DD+} - 1.3$	V_{DD-}	$V_{DD+} - 1.3$	V
Common-mode input voltage, V_{IC}	V_{DD-}	$V_{DD+} - 1.3$	V_{DD-}	$V_{DD+} - 1.3$	V
Operating free-air temperature, T_A	0	70	-40	85	°C

NOTE 1: All voltage values, except differential voltages, are with respect to V_{DD-} .



TLV2231, TLV2231Y
Advanced LinCMOS™ RAIL-TO-RAIL
LOW-POWER SINGLE OPERATIONAL AMPLIFIERS

SLOS158D – JUNE 1996 – REVISED APRIL 2001

electrical characteristics at specified free-air temperature, $V_{DD} = 3\text{ V}$ (unless otherwise noted)

PARAMETER	TEST CONDITIONS	T_A †	TLV2231C			TLV2231I			UNIT
			MIN	TYP	MAX	MIN	TYP	MAX	
V_{IO} Input offset voltage	$V_{DD} = \pm 1.5\text{ V}$, $V_{IC} = 0$, $V_O = 0$, $R_S = 50\ \Omega$	Full range	0.75	3		0.75	3		mV
αV_{IO} Temperature coefficient of input offset voltage			0.5			0.5			$\mu\text{V}/^\circ\text{C}$
Input offset voltage long-term drift (see Note 4)		25°C	0.003			0.003			$\mu\text{V}/\text{mo}$
I_{IO} Input offset current		25°C	0.5	60		0.5	60		pA
		Full range		150			150		
I_{IB} Input bias current		25°C	1	60		1	60		pA
	Full range		150			150			
V_{ICR} Common-mode input voltage range	$R_S = 50\ \Omega$, $ V_{IO} \leq 5\text{ mV}$	25°C	0 to 2	-0.3 to 2.2		0 to 2	-0.3 to 2.2		V
		Full range	0 to 1.7			0 to 1.7			
V_{OH} High-level output voltage	$I_{OH} = -1\text{ mA}$ $I_{OH} = -2\text{ mA}$	25°C	2.87			2.87			V
		25°C	2.74			2.74			
		Full range	2			2			
V_{OL} Low-level output voltage	$V_{IC} = 1.5\text{ V}$, $I_{OL} = 50\ \mu\text{A}$ $V_{IC} = 1.5\text{ V}$, $I_{OL} = 500\ \mu\text{A}$	25°C	10			10			mV
		25°C	100			100			
		Full range	300			300			
A_{VD} Large-signal differential voltage amplification	$V_{IC} = 1.5\text{ V}$, $V_O = 1\text{ V to }2\text{ V}$	25°C	$R_L = 600\ \Omega$ ‡		1	1.6	1	1.6	V/mV
			Full range		0.3		0.3		
		25°C	$R_L = 1\text{ M}\Omega$ ‡		250		250		
r_{id} Differential input resistance		25°C	10^{12}			10^{12}			Ω
r_{ic} Common-mode input resistance		25°C	10^{12}			10^{12}			Ω
c_{ic} Common-mode input capacitance	$f = 10\text{ kHz}$	25°C	6			6			pF
z_o Closed-loop output impedance	$f = 1\text{ MHz}$, $A_V = 1$	25°C	156			156			Ω
CMRR Common-mode rejection ratio	$V_{IC} = 0\text{ to }1.7\text{ V}$, $V_O = 1.5\text{ V}$, $R_S = 50\ \Omega$	25°C	60	70		60	70		dB
		Full range	55			55			
k_{SVR} Supply voltage rejection ratio ($\Delta V_{DD} / \Delta V_{IO}$)	$V_{DD} = 2.7\text{ V to }8\text{ V}$, $V_{IC} = V_{DD}/2$, No load	25°C	70	96		70	96		dB
		Full range	70			70			
I_{DD} Supply current	$V_O = 1.5\text{ V}$, No load	25°C	750	1200		750	1200		μA
		Full range	1500			1500			

† Full range for the TLV2231C is 0°C to 70°C. Full range for the TLV2231I is -40°C to 85°C.

‡ Referenced to 1.5 V

NOTE 4: Typical values are based on the input offset voltage shift observed through 500 hours of operating life test at $T_A = 150^\circ\text{C}$ extrapolated to $T_A = 25^\circ\text{C}$ using the Arrhenius equation and assuming an activation energy of 0.96 eV.



TLV2231, TLV2231Y
Advanced LinCMOS™ RAIL-TO-RAIL
LOW-POWER SINGLE OPERATIONAL AMPLIFIERS

SLOS158D – JUNE 1996 – REVISED APRIL 2001

operating characteristics at specified free-air temperature, $V_{DD} = 3\text{ V}$

PARAMETER	TEST CONDITIONS	T_A †	TLV2231C			TLV2231I			UNIT
			MIN	TYP	MAX	MIN	TYP	MAX	
SR	Slew rate at unity gain $V_O = 1.1\text{ V to }1.9\text{ V}, R_L = 600\ \Omega\ddagger, C_L = 100\text{ pF}\ddagger$	25°C	0.75	1.25		0.75	1.25	V/ μs	
		Full range	0.5			0.5			
V_n	Equivalent input noise voltage $f = 10\text{ Hz}$ $f = 1\text{ kHz}$	25°C	105			105			nV/ $\sqrt{\text{Hz}}$
		25°C	16			16			
$V_{N(PP)}$	Peak-to-peak equivalent input noise voltage $f = 0.1\text{ Hz to }1\text{ Hz}$ $f = 0.1\text{ Hz to }10\text{ Hz}$	25°C	1.4			1.4			μV
		25°C	1.5			1.5			
I_n	Equivalent input noise current	25°C	0.6			0.6			fA/ $\sqrt{\text{Hz}}$
THD+N	$V_O = 1\text{ V to }2\text{ V}, f = 20\text{ kHz}, R_L = 600\ \Omega\ddagger$	$A_V = 1$	0.285%			0.285%			
		$A_V = 10$	7.2%			7.2%			
	$V_O = 1\text{ V to }2\text{ V}, f = 20\text{ kHz}, R_L = 600\ \Omega\§$	$A_V = 1$	0.014%			0.014%			
		$A_V = 10$	0.098%			0.098%			
		$A_V = 100$	0.13%			0.13%			
Gain-bandwidth product	$f = 10\text{ kHz}, R_L = 600\ \Omega\ddagger, C_L = 100\text{ pF}\ddagger$	25°C	1.9			1.9			MHz
BOM	Maximum output-swing bandwidth $V_{O(PP)} = 1\text{ V}, R_L = 600\ \Omega\ddagger, A_V = 1, C_L = 100\text{ pF}\ddagger$	25°C	60			60			kHz
t_s	Settling time $A_V = -1, \text{ Step} = 1\text{ V to }2\text{ V}, R_L = 600\ \Omega\ddagger, C_L = 100\text{ pF}\ddagger$	To 0.1%	0.9			0.9			μs
		To 0.01%	1.5			1.5			
ϕ_m	Phase margin at unity gain $R_L = 600\ \Omega\ddagger, C_L = 100\text{ pF}\ddagger$	25°C	50°			50°			dB
		25°C	8			8			

† Full range is -40°C to 85°C .

‡ Referenced to 1.5 V

§ Referenced to 0 V



TLV2231, TLV2231Y
Advanced LinCMOS™ RAIL-TO-RAIL
LOW-POWER SINGLE OPERATIONAL AMPLIFIERS
SLOS158D – JUNE 1996 – REVISED APRIL 2001

electrical characteristics at specified free-air temperature, $V_{DD} = 5\text{ V}$ (unless otherwise noted)

PARAMETER	TEST CONDITIONS	T_A †	TLV2231C			TLV2231I			UNIT
			MIN	TYP	MAX	MIN	TYP	MAX	
V_{IO} Input offset voltage	$V_{DD} = \pm 2.5\text{ V}$, $V_O = 0$, $V_{IC} = 0$, $R_S = 50\ \Omega$	Full range	0.71	3		0.71	3		mV
αV_{IO} Temperature coefficient of input offset voltage			0.5			0.5			$\mu\text{V}/^\circ\text{C}$
Input offset voltage long-term drift (see Note 4)		25°C	0.003			0.003			$\mu\text{V}/\text{mo}$
I_{IO} Input offset current		25°C	0.5	60		0.5	60		pA
		Full range		150			150		
I_{IB} Input bias current	25°C	1	60		1	60		pA	
	Full range		150			150			
V_{ICR} Common-mode input voltage range	$R_S = 50\ \Omega$, $ V_{IO} \leq 5\text{ mV}$	25°C	0 to 4	-0.3 to 4.2		0 to 4	-0.3 to 4.2		V
		Full range	0 to 3.7			0 to 3.7			
V_{OH} High-level output voltage	$I_{OH} = -1\text{ mA}$ $I_{OH} = -4\text{ mA}$	25°C	4.9			4.9			V
		25°C	4.6			4.6			
		Full range	4			4			
V_{OL} Low-level output voltage	$V_{IC} = 2.5\text{ V}$, $I_{OL} = 500\ \mu\text{A}$ $V_{IC} = 2.5\text{ V}$, $I_{OL} = 1\text{ mA}$	25°C	80			80		mV	
		25°C	160			160			
		Full range		500			500		
A_{VD} Large-signal differential voltage amplification	$V_{IC} = 2.5\text{ V}$, $V_O = 1\text{ V to }4\text{ V}$	25°C	$R_L = 600\ \Omega$ ‡		1	1.5	1	1.5	V/mV
			Full range		0.3		0.3		
		25°C	$R_L = 1\text{ M}\Omega$ ‡		400		400		
r_{id} Differential input resistance		25°C	10^{12}			10^{12}			Ω
r_{ic} Common-mode input resistance		25°C	10^{12}			10^{12}			Ω
c_{ic} Common-mode input capacitance	$f = 10\text{ kHz}$	25°C	6			6			pF
z_o Closed-loop output impedance	$f = 1\text{ MHz}$, $A_V = 1$	25°C	138			138			Ω
CMRR Common-mode rejection ratio	$V_{IC} = 0\text{ to }2.7\text{ V}$, $V_O = 2.5\text{ V}$, $R_S = 50\ \Omega$	25°C	60	70		60	70		dB
		Full range	55			55			
k_{SVR} Supply voltage rejection ratio ($\Delta V_{DD} / \Delta V_{IO}$)	$V_{DD} = 4.4\text{ V to }8\text{ V}$, $V_{IC} = V_{DD}/2$, No load	25°C	70	96		70	96		dB
		Full range	70			70			
I_{DD} Supply current	$V_O = 2.5\text{ V}$, No load	25°C	850	1300		850	1300		μA
		Full range		1600			1600		

† Full range for the TLV2231C is 0°C to 70°C. Full range for the TLV2231I is -40°C to 85°C.

‡ Referenced to 2.5 V

NOTE 5: Typical values are based on the input offset voltage shift observed through 500 hours of operating life test at $T_A = 150^\circ\text{C}$ extrapolated to $T_A = 25^\circ\text{C}$ using the Arrhenius equation and assuming an activation energy of 0.96 eV.



TLV2231, TLV2231Y
Advanced LinCMOS™ RAIL-TO-RAIL
LOW-POWER SINGLE OPERATIONAL AMPLIFIERS

SLOS158D – JUNE 1996 – REVISED APRIL 2001

operating characteristics at specified free-air temperature, $V_{DD} = 5\text{ V}$

PARAMETER	TEST CONDITIONS	T_A †	TLV2231C			TLV2231I			UNIT
			MIN	TYP	MAX	MIN	TYP	MAX	
SR	Slew rate at unity gain $V_O = 1.5\text{ V to }3.5\text{ V}, R_L = 600\ \Omega\ddagger, C_L = 100\text{ pF}\ddagger$	25°C	1	1.6		1	1.6	$\text{V}/\mu\text{s}$	
		Full range	0.7			0.7			
V_n	Equivalent input noise voltage $f = 10\text{ Hz}$ $f = 1\text{ kHz}$	25°C		100			100	$\text{nV}/\sqrt{\text{Hz}}$	
		25°C		15			15		
$V_{N(PP)}$	Peak-to-peak equivalent input noise voltage $f = 0.1\text{ Hz to }1\text{ Hz}$ $f = 0.1\text{ Hz to }10\text{ Hz}$	25°C		1.4			1.4	μV	
		25°C		1.5			1.5		
I_n	Equivalent input noise current	25°C		0.6			0.6	$\text{fA}/\sqrt{\text{Hz}}$	
THD+N	Total harmonic distortion plus noise $V_O = 1.5\text{ V to }3.5\text{ V}, f = 20\text{ kHz}, R_L = 600\ \Omega\ddagger$ $V_O = 1.5\text{ V to }3.5\text{ V}, f = 20\text{ kHz}, R_L = 600\ \Omega\§$	25°C		$A_V = 1$		0.409%		0.409%	
				$A_V = 10$		3.68%		3.68%	
		25°C		$A_V = 1$		0.018%		0.018%	
				$A_V = 10$		0.045%		0.045%	
				$A_V = 100$		0.116%		0.116%	
		Gain-bandwidth product	$f = 10\text{ kHz}, R_L = 600\ \Omega\ddagger, C_L = 100\text{ pF}\ddagger$	25°C		2			2
B_{OM}	Maximum output-swing bandwidth $V_{O(PP)} = 1\text{ V}, R_L = 600\ \Omega\ddagger, A_V = 1, C_L = 100\text{ pF}\ddagger$	25°C		300			300	kHz	
t_s	Settling time $A_V = -1, \text{ Step} = 1.5\text{ V to }3.5\text{ V}, R_L = 600\ \Omega\ddagger, C_L = 100\text{ pF}\ddagger$	25°C		To 0.1%		0.95		0.95	μs
				To 0.01%		2.4		2.4	
ϕ_m	Phase margin at unity gain $R_L = 600\ \Omega\ddagger, C_L = 100\text{ pF}\ddagger$	25°C		48°			48°		
		25°C		8			8	dB	
	Gain margin	25°C		8			8	dB	

† Full range is -40°C to 85°C .

‡ Referenced to 2.5 V

§ Referenced to 0 V



TLV2231, TLV2231Y
Advanced LinCMOS™ RAIL-TO-RAIL
LOW-POWER SINGLE OPERATIONAL AMPLIFIERS

SLOS158D – JUNE 1996 – REVISED APRIL 2001

electrical characteristics at $V_{DD} = 3\text{ V}$, $T_A = 25^\circ\text{C}$ (unless otherwise noted)

PARAMETER	TEST CONDITIONS	TLV2231Y			UNIT
		MIN	TYP	MAX	
V_{IO} Input offset voltage	$V_{DD} \pm \pm 1.5\text{ V}$, $R_S = 50\ \Omega$	$V_{IC} = 0$,	$V_O = 0$,	750	μV
I_{IO} Input offset current				0.5	pA
I_{IB} Input bias current				1	pA
V_{ICR} Common-mode input voltage range	$ V_{IO} \leq 5\text{ mV}$, $R_S = 50\ \Omega$			-0.3 to 2.2	V
V_{OH} High-level output voltage	$I_{OH} = -1\text{ mA}$			2.87	V
V_{OL} Low-level output voltage	$V_{IC} = 1.5\text{ V}$,	$I_{OL} = 50\ \mu\text{A}$		10	mV
	$V_{IC} = 1.5\text{ V}$,	$I_{OL} = 500\ \mu\text{A}$		100	
A_{VD} Large-signal differential voltage amplification	$V_O = 1\text{ V to }2\text{ V}$	$R_L = 600\ \Omega^\dagger$		1.6	V/mV
		$R_L = 1\text{ M}\Omega^\dagger$		250	
r_{id} Differential input resistance				10^{12}	Ω
r_{ic} Common-mode input resistance				10^{12}	Ω
C_{ic} Common-mode input capacitance	$f = 10\text{ kHz}$			6	pF
Z_o Closed-loop output impedance	$f = 1\text{ MHz}$,	$A_V = 1$		156	Ω
CMRR Common-mode rejection ratio	$V_{IC} = 0\text{ to }1.7\text{ V}$,	$V_O = 0$,	$R_S = 50\ \Omega$	60 70	dB
k_{SVR} Supply voltage rejection ratio ($\Delta V_{DD}/\Delta V_{IO}$)	$V_{DD} = 2.7\text{ V to }8\text{ V}$,	$V_{IC} = 0$,	No load	96	dB
I_{DD} Supply current	$V_O = 0$,	No load		750	μA

† Referenced to 1.5 V

electrical characteristics at $V_{DD} = 5\text{ V}$, $T_A = 25^\circ\text{C}$ (unless otherwise noted)

PARAMETER	TEST CONDITIONS	TLV2231Y			UNIT
		MIN	TYP	MAX	
V_{IO} Input offset voltage	$V_{DD} \pm \pm 1.5\text{ V}$, $R_S = 50\ \Omega$	$V_{IC} = 0$,	$V_O = 0$,	710	μV
I_{IO} Input offset current				0.5	pA
I_{IB} Input bias current				1	pA
V_{ICR} Common-mode input voltage range	$ V_{IO} \leq 5\text{ mV}$, $R_S = 50\ \Omega$			-0.3 to 4.2	V
V_{OH} High-level output voltage	$I_{OH} = -1\text{ mA}$			4.9	V
V_{OL} Low-level output voltage	$V_{IC} = 2.5\text{ V}$,	$I_{OL} = 500\ \mu\text{A}$		80	mV
	$V_{IC} = 2.5\text{ V}$,	$I_{OL} = 1\text{ mA}$		160	
A_{VD} Large-signal differential voltage amplification	$V_O = 1\text{ V to }2\text{ V}$	$R_L = 600\ \Omega^\dagger$		15	V/mV
		$R_L = 1\text{ M}\Omega^\dagger$		400	
r_{id} Differential input resistance				10^{12}	Ω
r_{ic} Common-mode input resistance				10^{12}	Ω
C_{ic} Common-mode input capacitance	$f = 10\text{ kHz}$			6	pF
Z_o Closed-loop output impedance	$f = 1\text{ MHz}$,	$A_V = 1$		138	Ω
CMRR Common-mode rejection ratio	$V_{IC} = 0\text{ to }1.7\text{ V}$,	$V_O = 0$,	$R_S = 50\ \Omega$	60 70	dB
k_{SVR} Supply voltage rejection ratio ($\Delta V_{DD}/\Delta V_{IO}$)	$V_{DD} = 2.7\text{ V to }8\text{ V}$,	$V_{IC} = 0$,	No load	96	dB
I_{DD} Supply current	$V_O = 0$,	No load		850	μA

† Referenced to 2.5 V



TYPICAL CHARACTERISTICS

Table of Graphs

		FIGURE
V_{IO}	Input offset voltage	Distribution vs Common-mode input voltage
		2, 3 4, 5
α_{VIO}	Input offset voltage temperature coefficient	Distribution
		6, 7
I_{IB}/I_{IO}	Input bias and input offset currents	vs Free-air temperature
		8
V_I	Input voltage	vs Supply voltage vs Free-air temperature
		9 10
V_{OH}	High-level output voltage	vs High-level output current
		11, 14
V_{OL}	Low-level output voltage	vs Low-level output current
		12, 13, 15
$V_{O(PP)}$	Maximum peak-to-peak output voltage	vs Frequency
		16
I_{OS}	Short-circuit output current	vs Supply voltage vs Free-air temperature
		17 18
V_O	Output voltage	vs Differential input voltage
		19, 20
A_{VD}	Differential voltage amplification	vs Load resistance
		21
A_{VD}	Large-signal differential voltage amplification	vs Frequency vs Free-air temperature
		22, 23 24, 25
z_o	Output impedance	vs Frequency
		26, 27
$CMRR$	Common-mode rejection ratio	vs Frequency vs Free-air temperature
		28 29
k_{SVR}	Supply-voltage rejection ratio	vs Frequency vs Free-air temperature
		30, 31 32
I_{DD}	Supply current	vs Supply voltage
		33
SR	Slew rate	vs Load capacitance vs Free-air temperature
		34 35
V_O	Inverting large-signal pulse response	vs Time
		36, 37
V_O	Voltage-follower large-signal pulse response	vs Time
		38, 39
V_O	Inverting small-signal pulse response	vs Time
		40, 41
V_O	Voltage-follower small-signal pulse response	vs Time
		42, 43
V_n	Equivalent input noise voltage	vs Frequency
		44, 45
	Noise voltage (referred to input)	Over a 10-second period
		46
$THD + N$	Total harmonic distortion plus noise	vs Frequency
		47
	Gain-bandwidth product	vs Free-air temperature vs Supply voltage
		48 49
	Gain margin	vs Load capacitance
		50, 51
ϕ_m	Phase margin	vs Frequency vs Load capacitance
		22, 23 52, 53
B_1	Unity-gain bandwidth	vs Load capacitance
		54, 55



TYPICAL CHARACTERISTICS

**DISTRIBUTION OF TLV2231
INPUT OFFSET VOLTAGE**

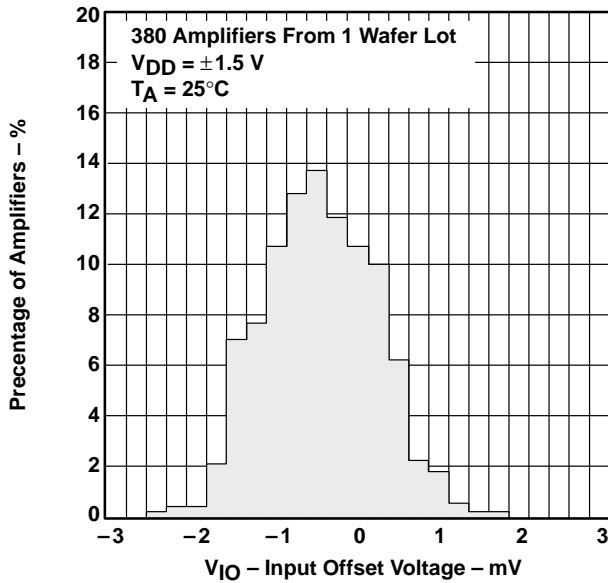

Figure 2

**DISTRIBUTION OF TLV2231
INPUT OFFSET VOLTAGE**

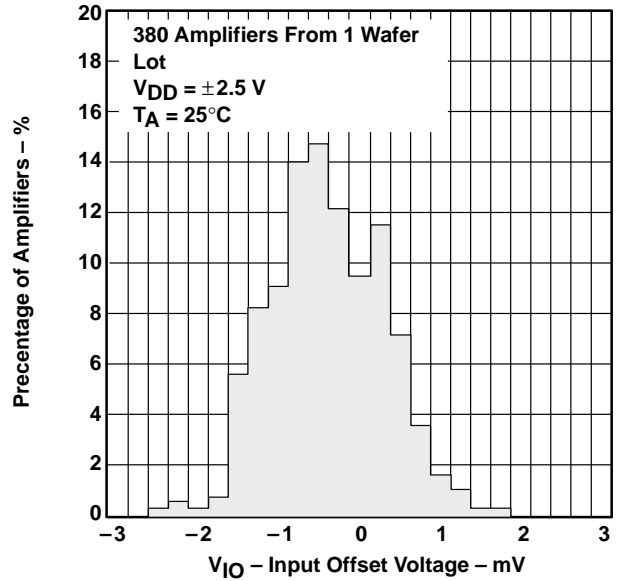

Figure 3

**INPUT OFFSET VOLTAGE†
vs
COMMON-MODE INPUT VOLTAGE**

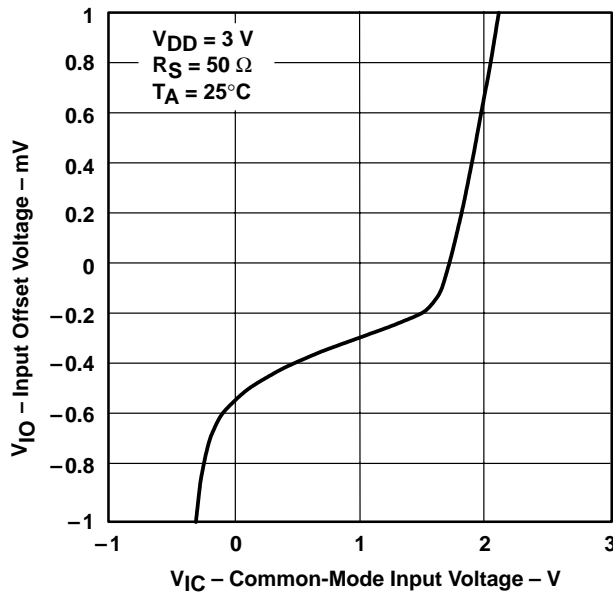

Figure 4

**INPUT OFFSET VOLTAGE†
vs
COMMON-MODE INPUT VOLTAGE**

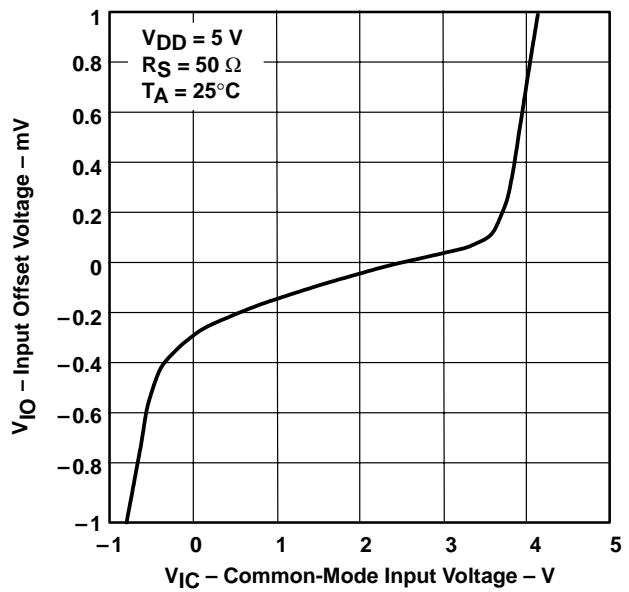

Figure 5

† For all curves where $V_{DD} = 5 \text{ V}$, all loads are referenced to 2.5 V. For all curves where $V_{DD} = 3 \text{ V}$, all loads are referenced to 1.5 V.

TYPICAL CHARACTERISTICS

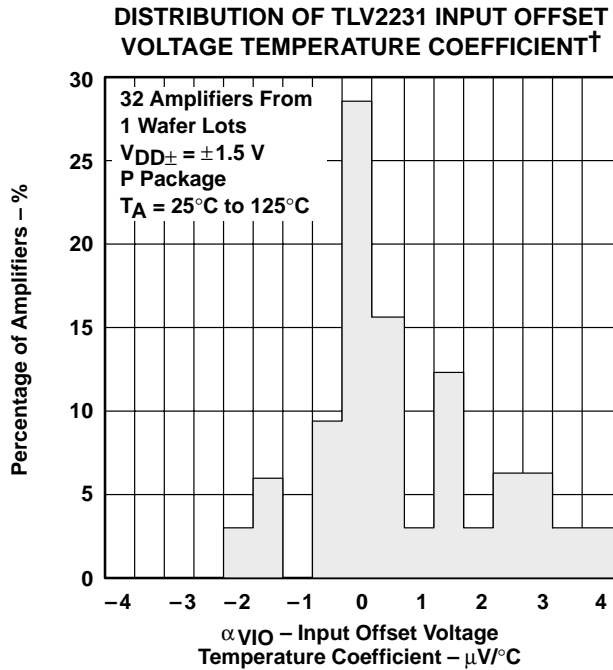

Figure 6

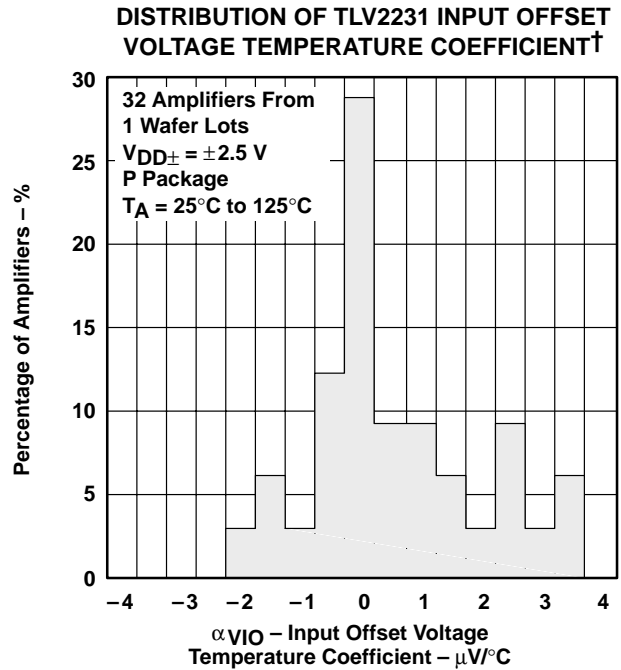

Figure 7

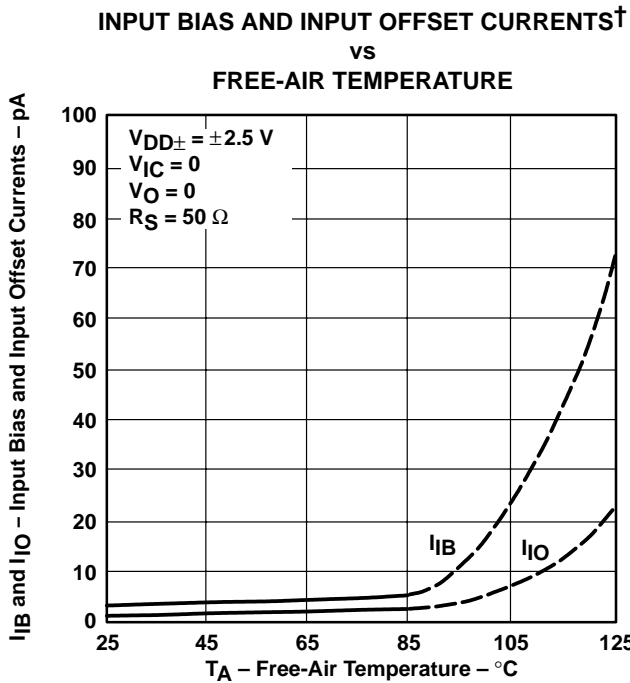

Figure 8

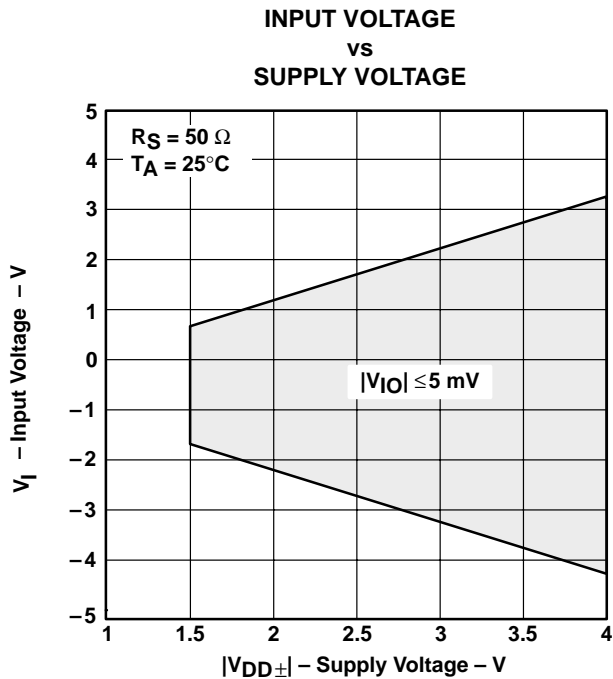

Figure 9

† Data at high and low temperatures are applicable only within the rated operating free-air temperature ranges of the various devices.

TYPICAL CHARACTERISTICS

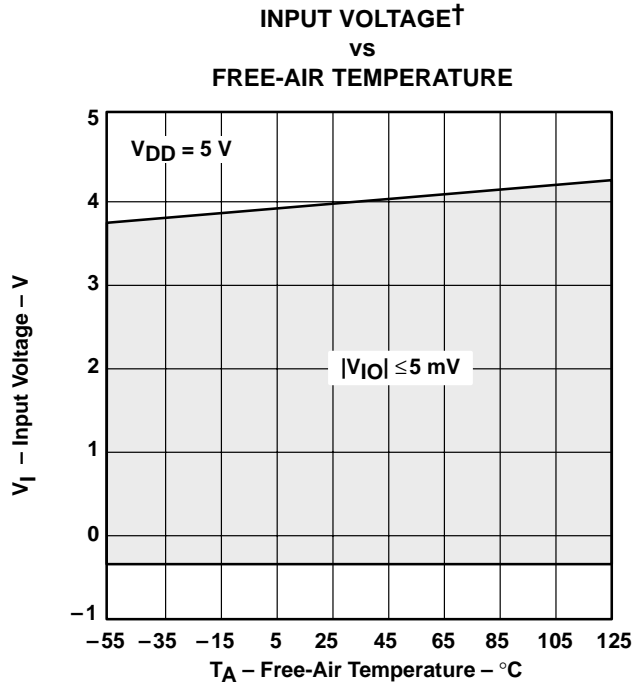

Figure 10

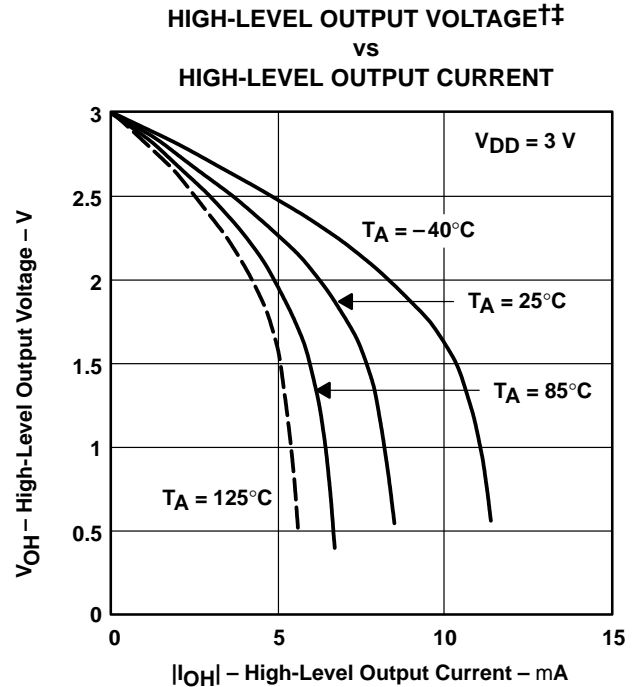

Figure 11

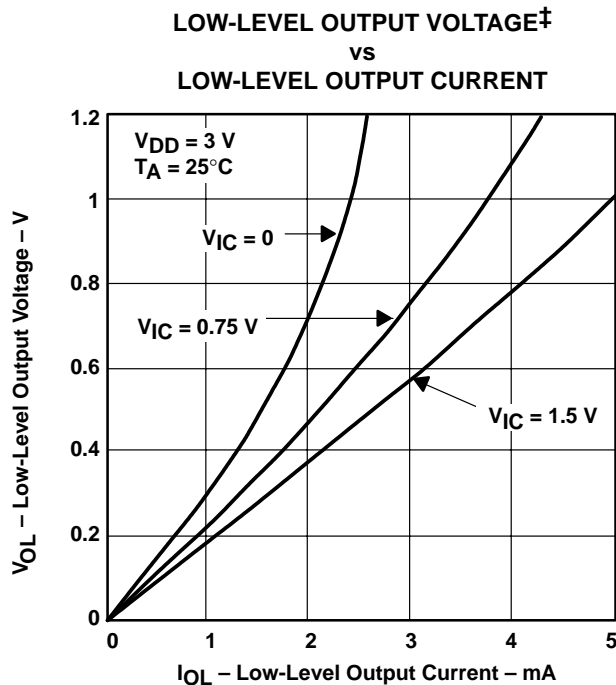

Figure 12

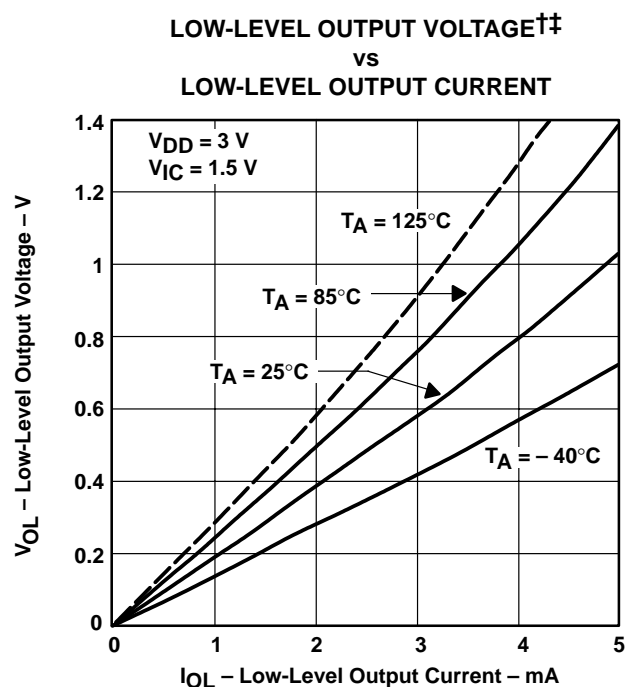

Figure 13

† Data at high and low temperatures are applicable only within the rated operating free-air temperature ranges of the various devices.

‡ For all curves where $V_{DD} = 5\text{ V}$, all loads are referenced to 2.5 V. For all curves where $V_{DD} = 3\text{ V}$, all loads are referenced to 1.5 V.

TYPICAL CHARACTERISTICS

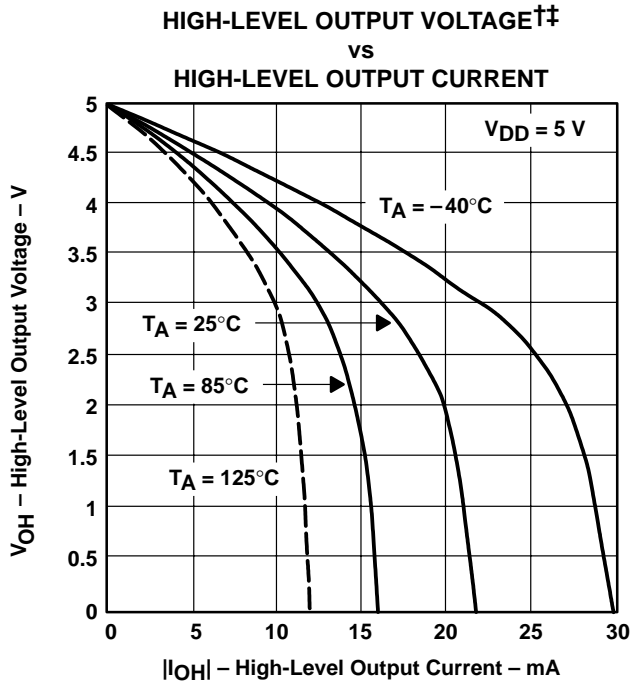

Figure 14

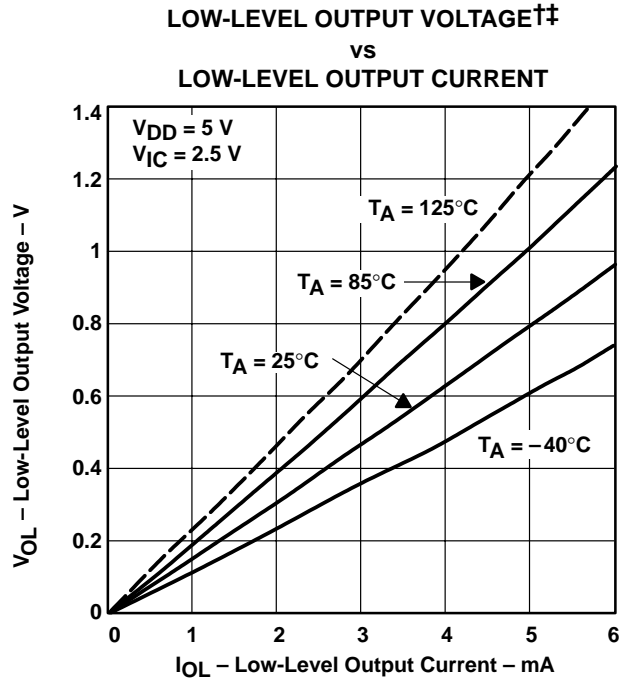

Figure 15

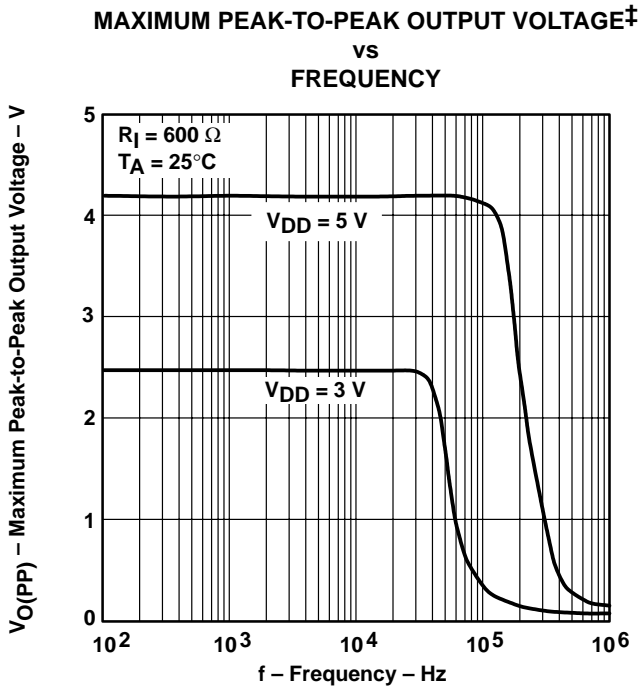

Figure 16

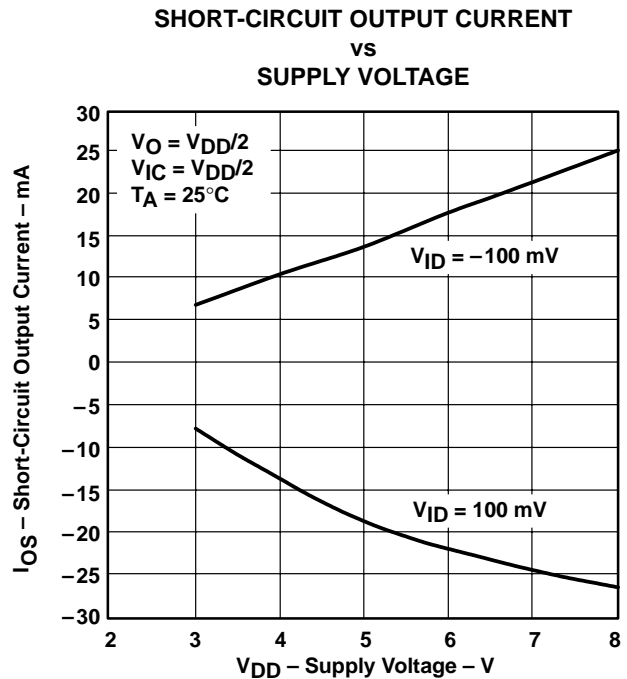
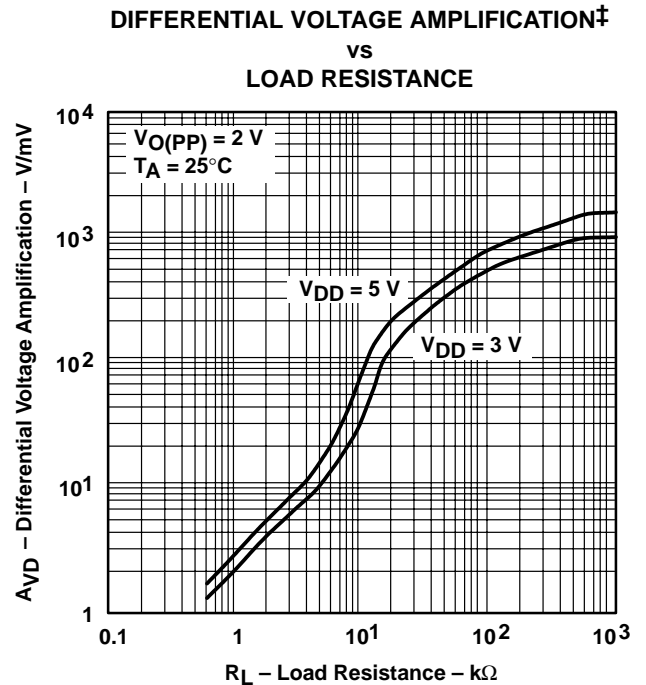
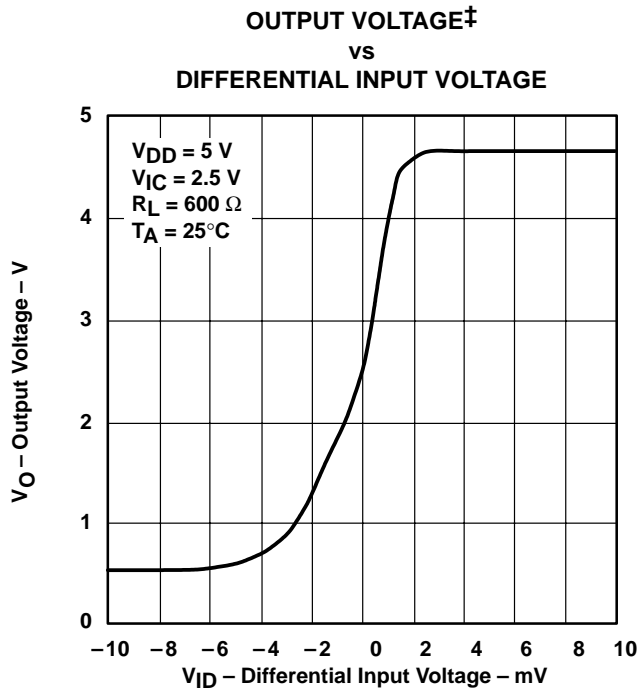
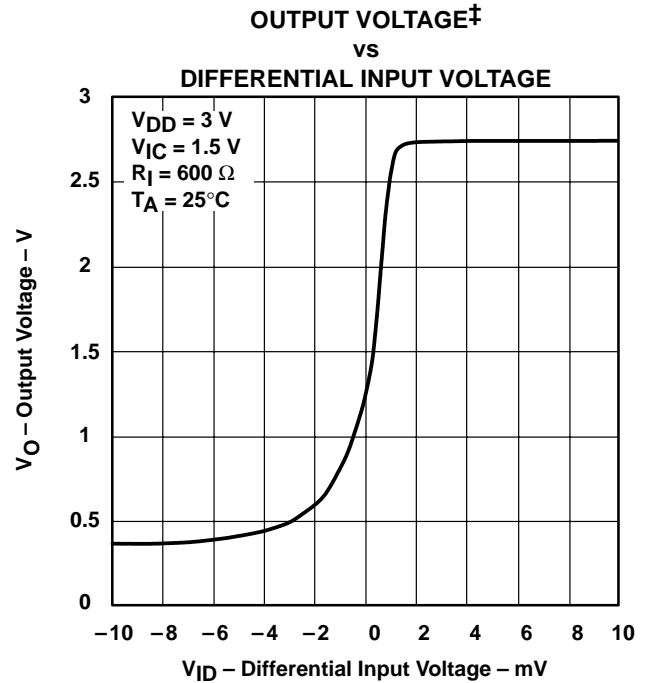
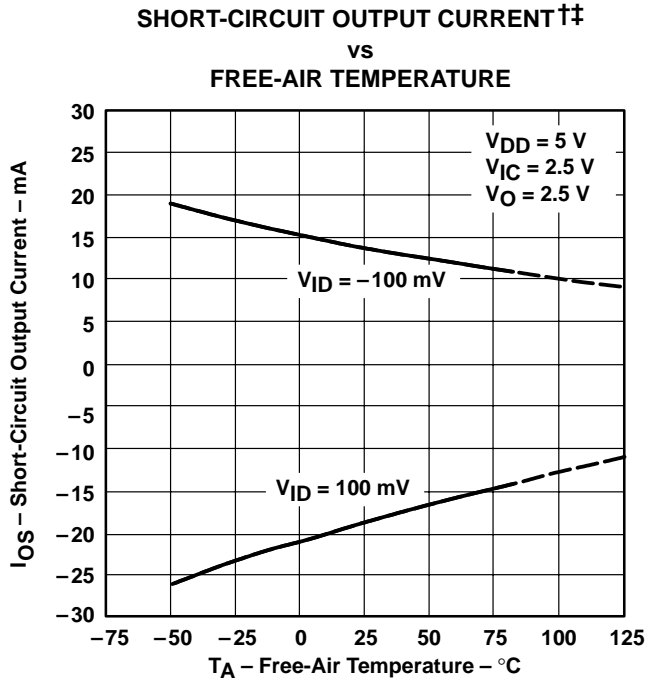

Figure 17

† Data at high and low temperatures are applicable only within the rated operating free-air temperature ranges of the various devices.
 ‡ For all curves where $V_{DD} = 5\text{ V}$, all loads are referenced to 2.5 V. For all curves where $V_{DD} = 3\text{ V}$, all loads are referenced to 1.5 V.

TYPICAL CHARACTERISTICS



† Data at high and low temperatures are applicable only within the rated operating free-air temperature ranges of the various devices.
 †† For all curves where $V_{DD} = 5\text{ V}$, all loads are referenced to 2.5 V. For all curves where $V_{DD} = 3\text{ V}$, all loads are referenced to 1.5 V.

TYPICAL CHARACTERISTICS

LARGE-SIGNAL DIFFERENTIAL VOLTAGE
 AMPLIFICATION AND PHASE MARGIN†
 vs
 FREQUENCY

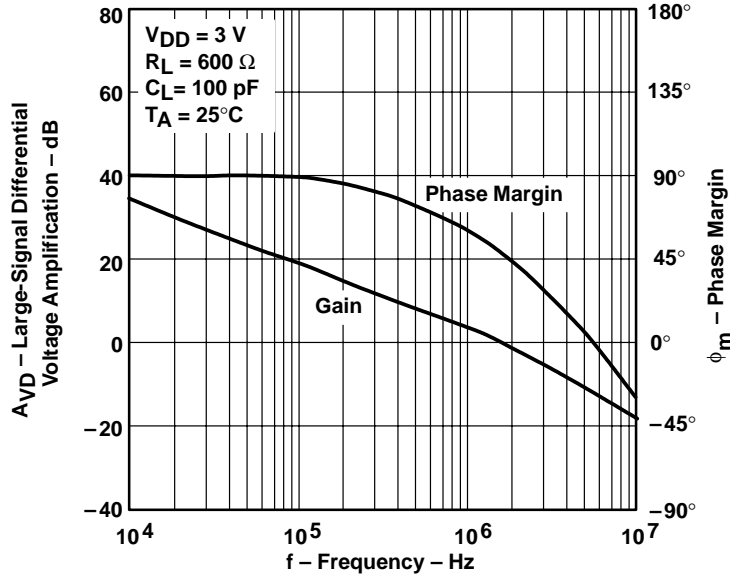

Figure 22

LARGE-SIGNAL DIFFERENTIAL VOLTAGE
 AMPLIFICATION AND PHASE MARGIN†
 vs
 FREQUENCY

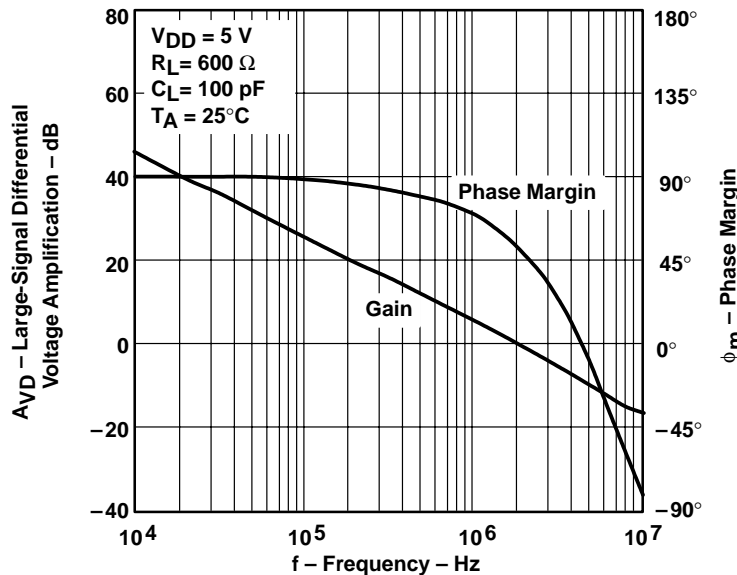
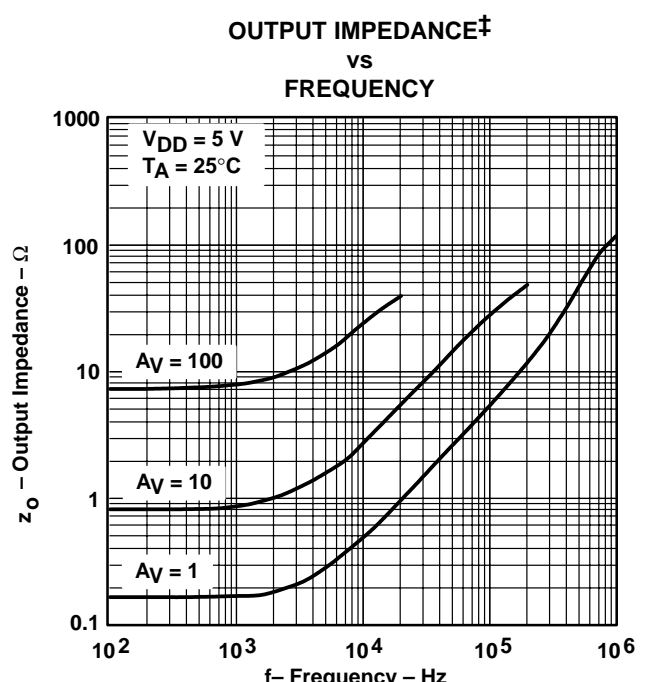
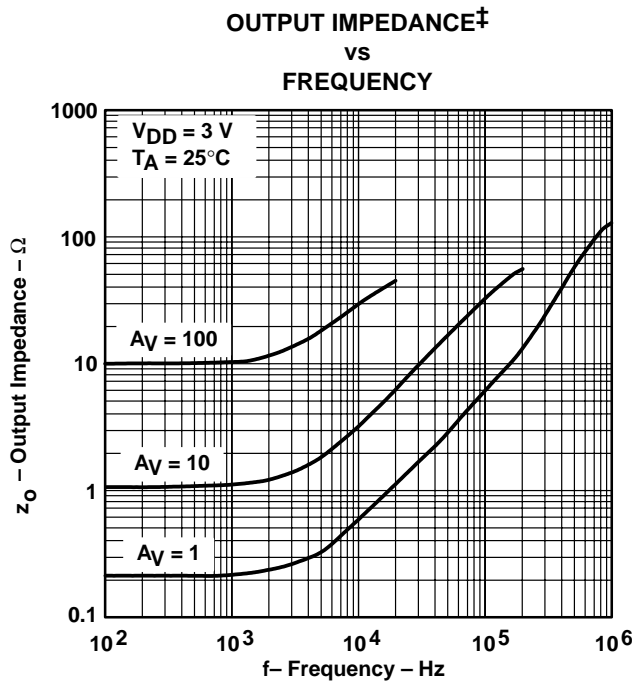
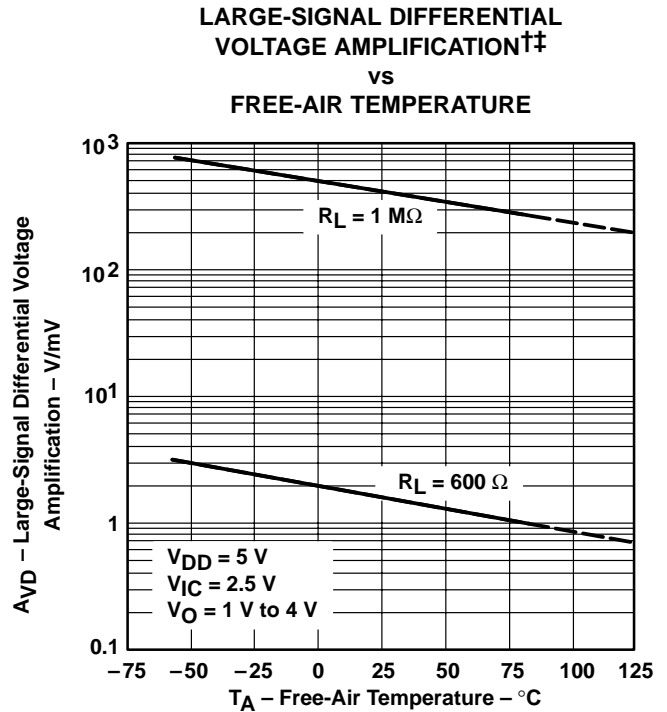
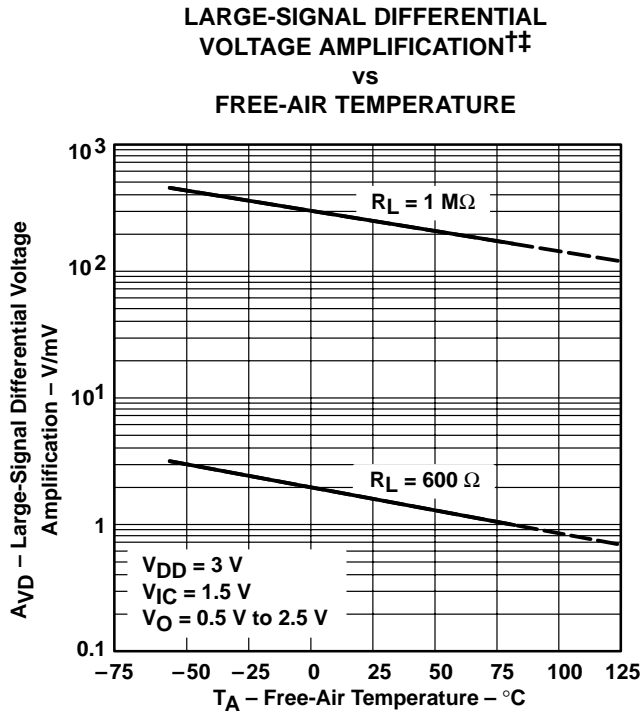

Figure 23

† For all curves where $V_{DD} = 5\text{ V}$, all loads are referenced to 2.5 V. For all curves where $V_{DD} = 3\text{ V}$, all loads are referenced to 1.5 V.

TYPICAL CHARACTERISTICS



† Data at high and low temperatures are applicable only within the rated operating free-air temperature ranges of the various devices.
 ‡ For all curves where $V_{DD} = 5\text{ V}$, all loads are referenced to 2.5 V. For all curves where $V_{DD} = 3\text{ V}$, all loads are referenced to 1.5 V.

TYPICAL CHARACTERISTICS

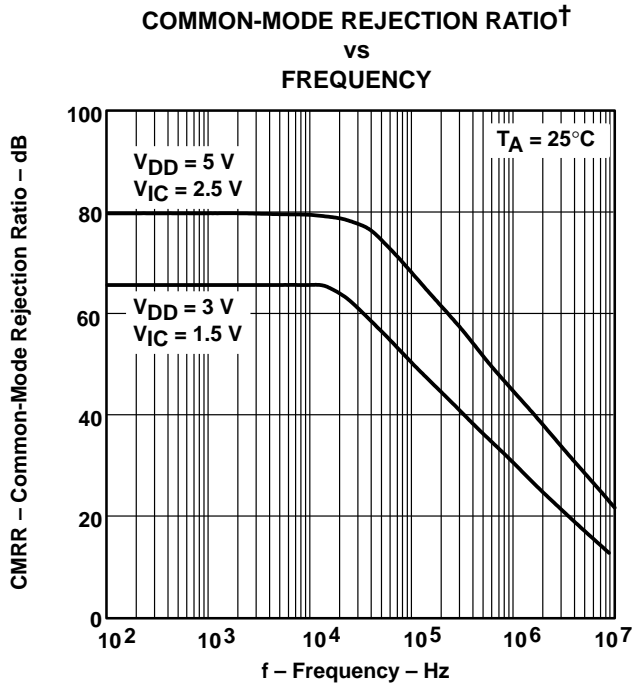

Figure 28

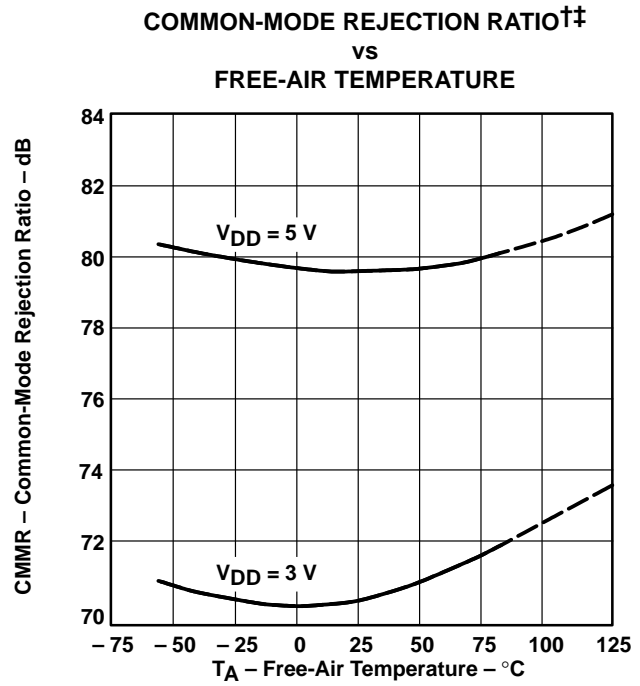

Figure 29

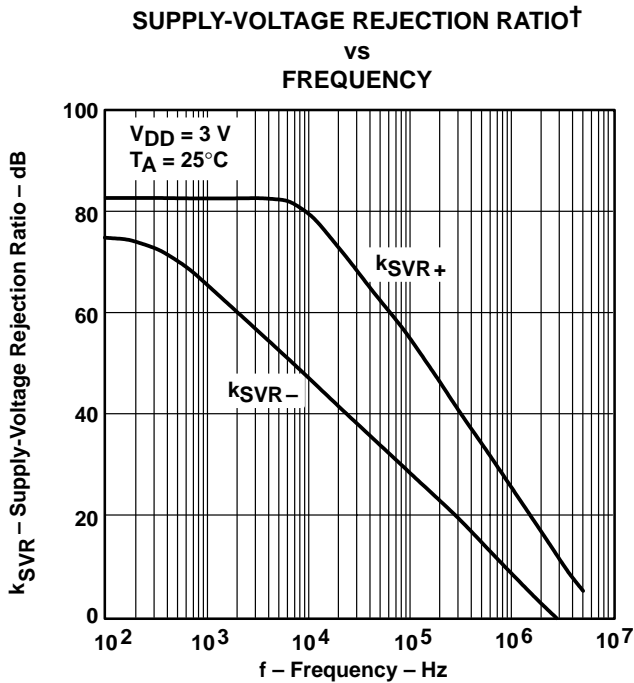

Figure 30

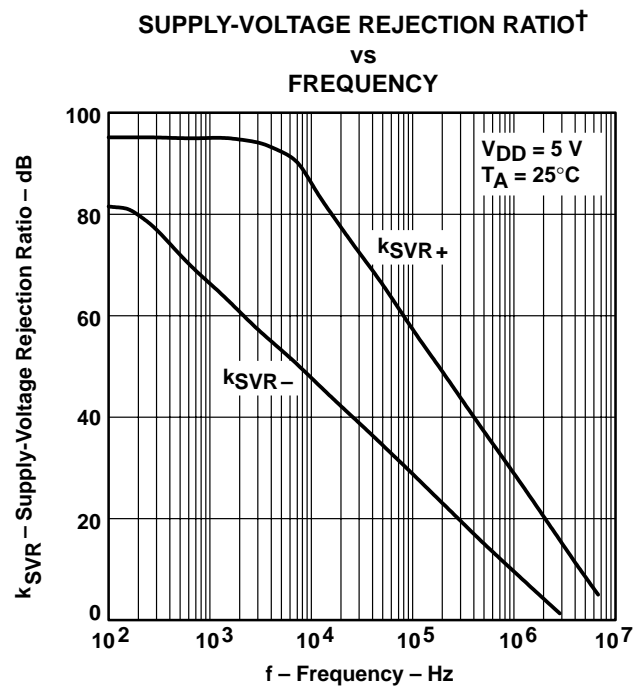
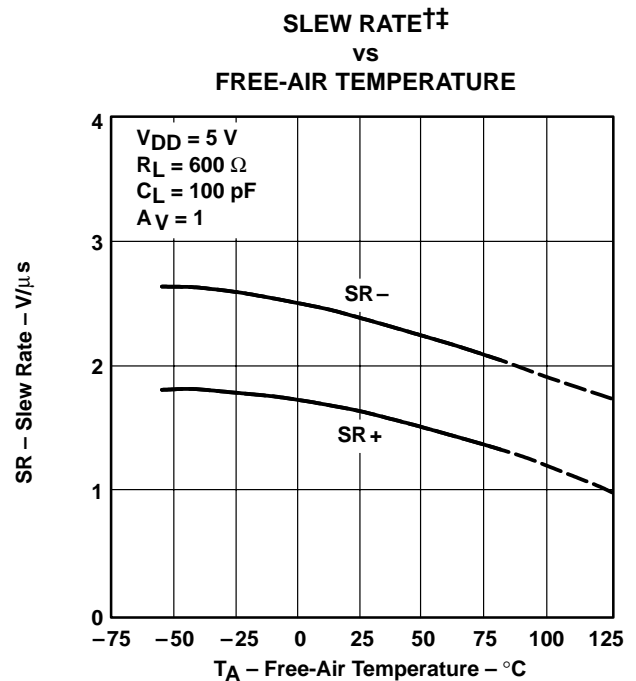
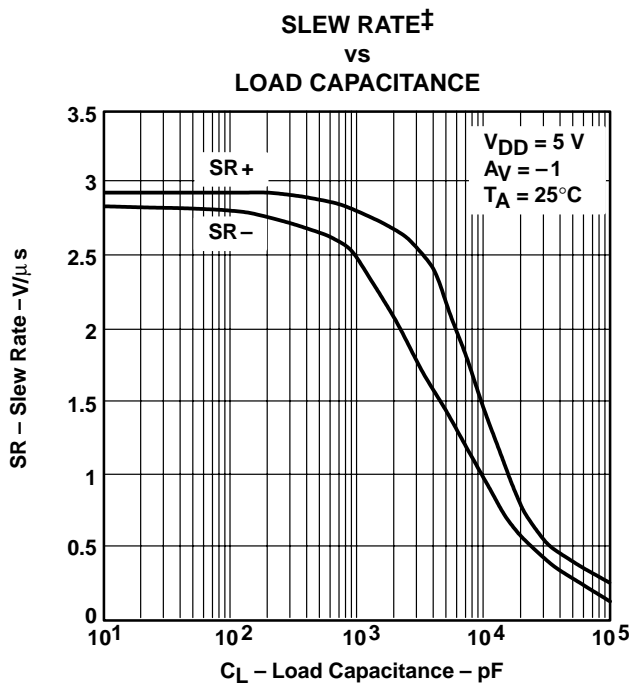
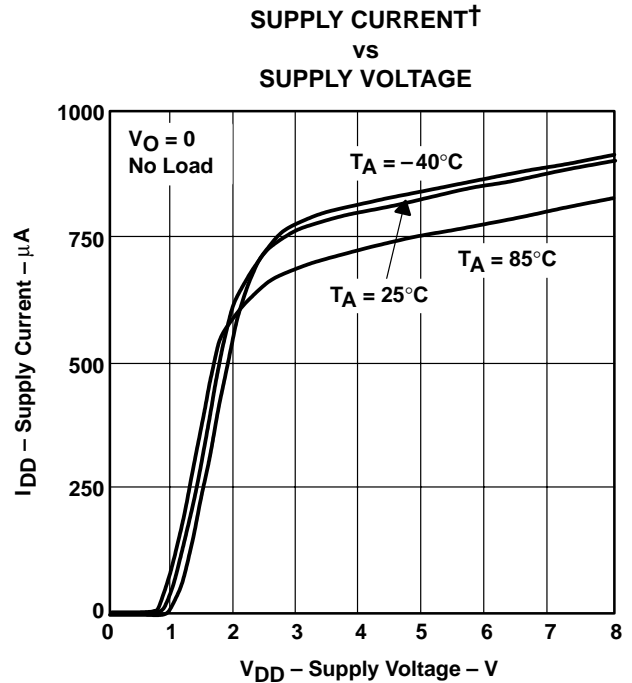
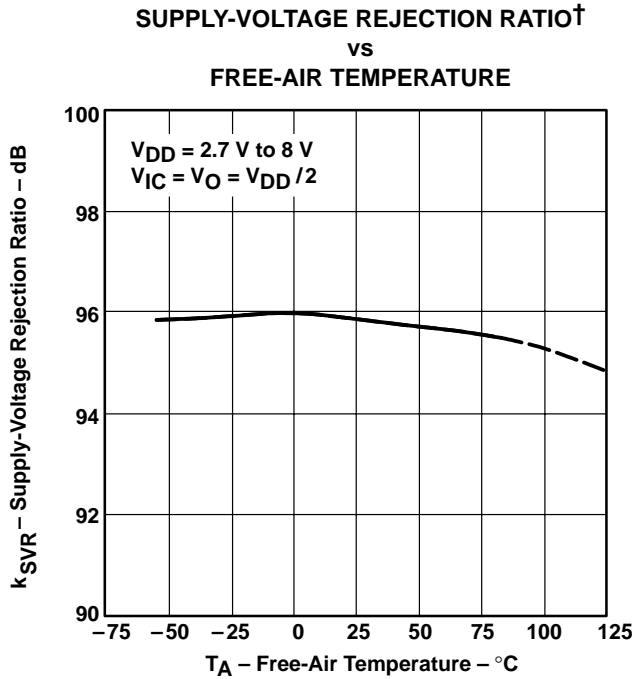

Figure 31

† For all curves where $V_{DD} = 5\text{ V}$, all loads are referenced to 2.5 V. For all curves where $V_{DD} = 3\text{ V}$, all loads are referenced to 1.5 V.
 ‡ Data at high and low temperatures are applicable only within the rated operating free-air temperature ranges of the various devices.

TYPICAL CHARACTERISTICS



† Data at high and low temperatures are applicable only within the rated operating free-air temperature ranges of the various devices.
 ‡ For all curves where $V_{DD} = 5\text{ V}$, all loads are referenced to 2.5 V. For all curves where $V_{DD} = 3\text{ V}$, all loads are referenced to 1.5 V.

TYPICAL CHARACTERISTICS

INVERTING LARGE-SIGNAL PULSE RESPONSE†

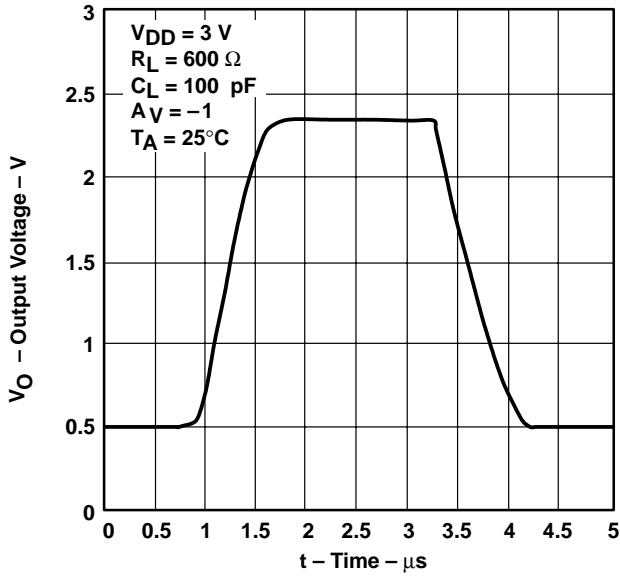

Figure 36

INVERTING LARGE-SIGNAL PULSE RESPONSE†

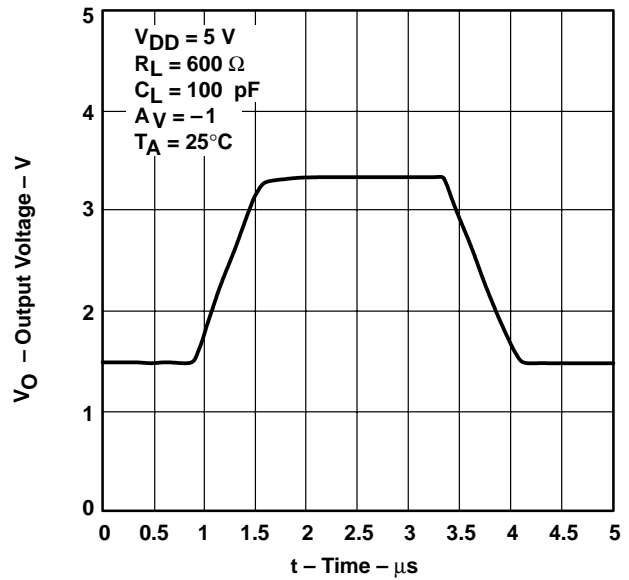

Figure 37

VOLTAGE-FOLLOWER LARGE-SIGNAL PULSE RESPONSE†

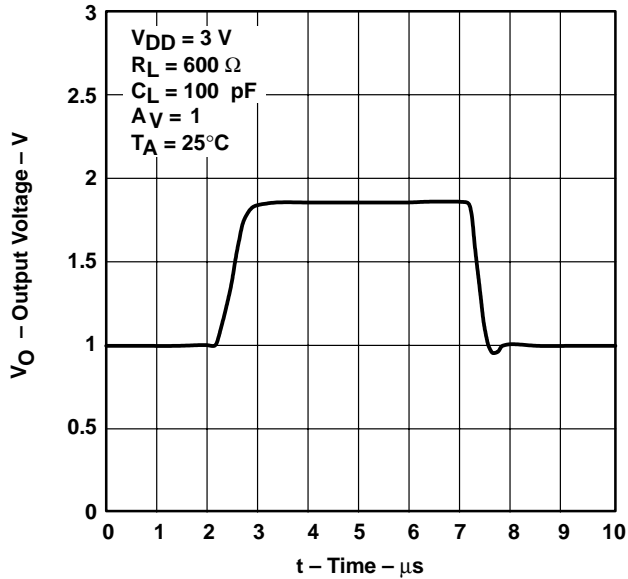

Figure 38

VOLTAGE-FOLLOWER LARGE-SIGNAL PULSE RESPONSE†

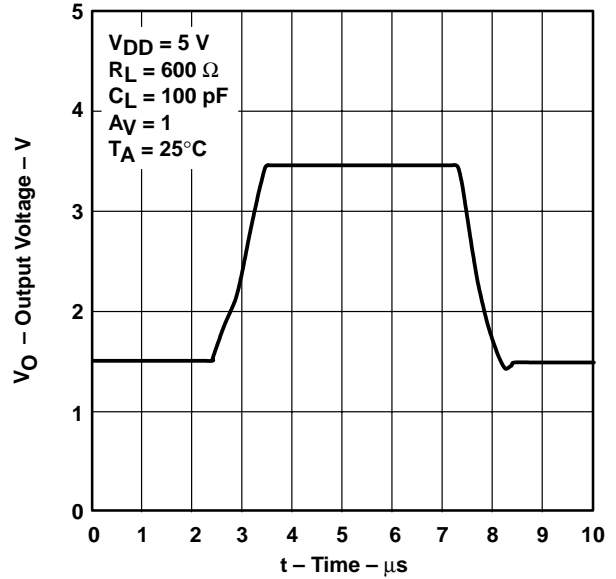

Figure 39

† For all curves where $V_{DD} = 5\text{ V}$, all loads are referenced to 2.5 V. For all curves where $V_{DD} = 3\text{ V}$, all loads are referenced to 1.5 V.

TYPICAL CHARACTERISTICS

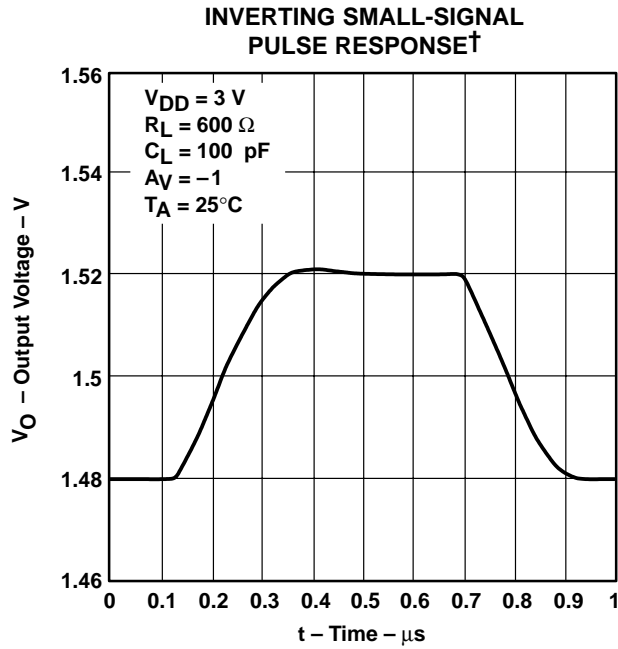

Figure 40

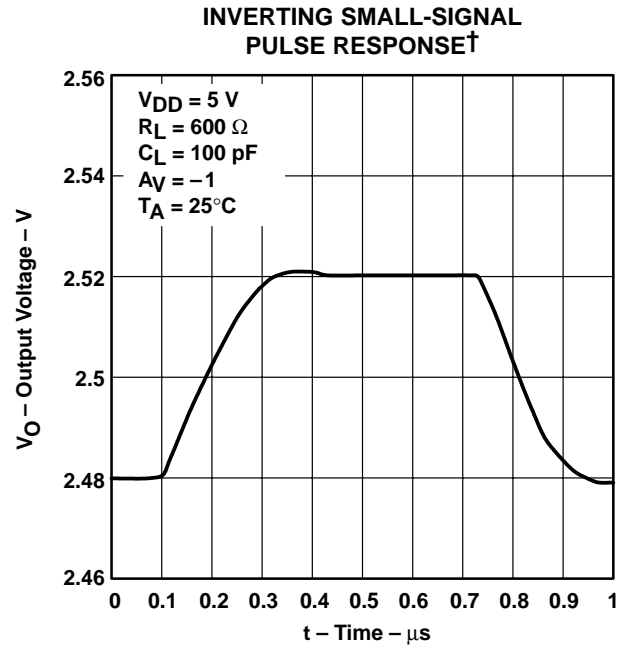

Figure 41

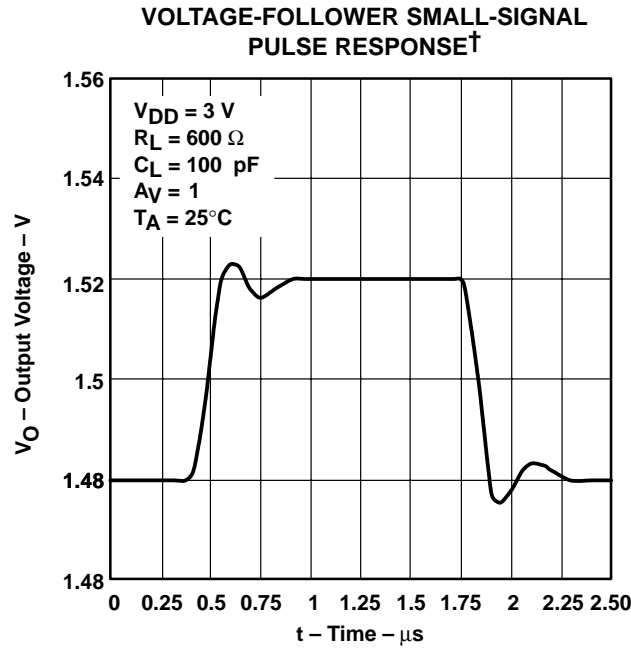

Figure 42

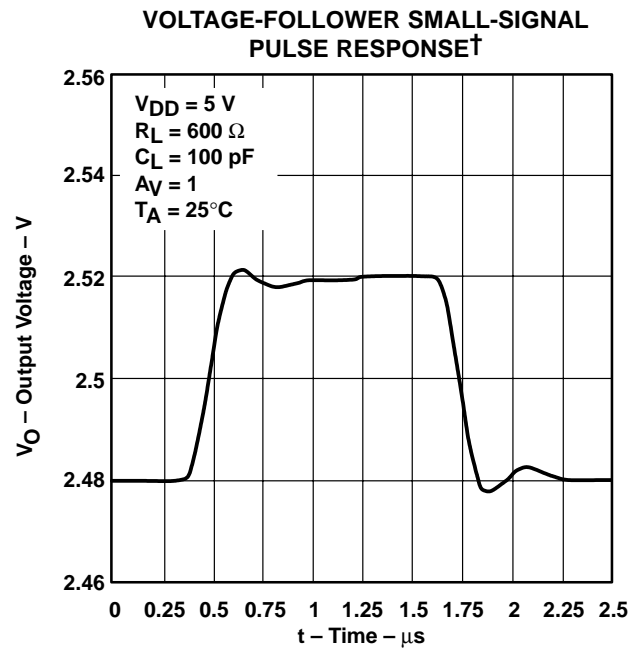

Figure 43

† For all curves where $V_{DD} = 5\text{ V}$, all loads are referenced to 2.5 V. For all curves where $V_{DD} = 3\text{ V}$, all loads are referenced to 1.5 V.

TYPICAL CHARACTERISTICS

EQUIVALENT INPUT NOISE VOLTAGE†
 VS
 FREQUENCY

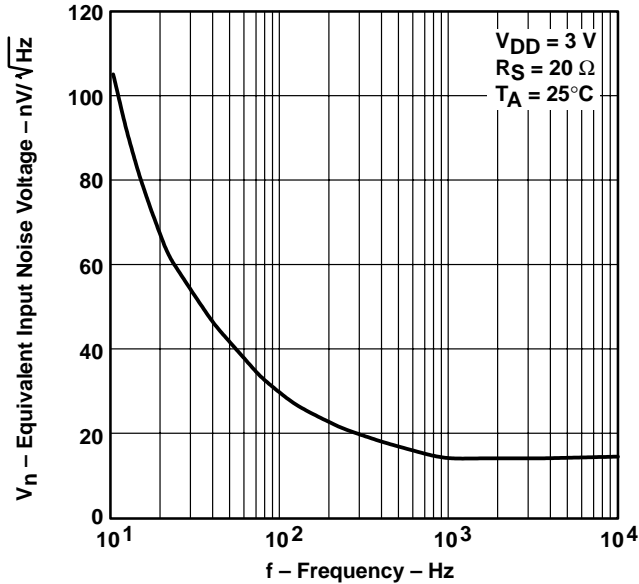

Figure 44

EQUIVALENT INPUT NOISE VOLTAGE†
 VS
 FREQUENCY

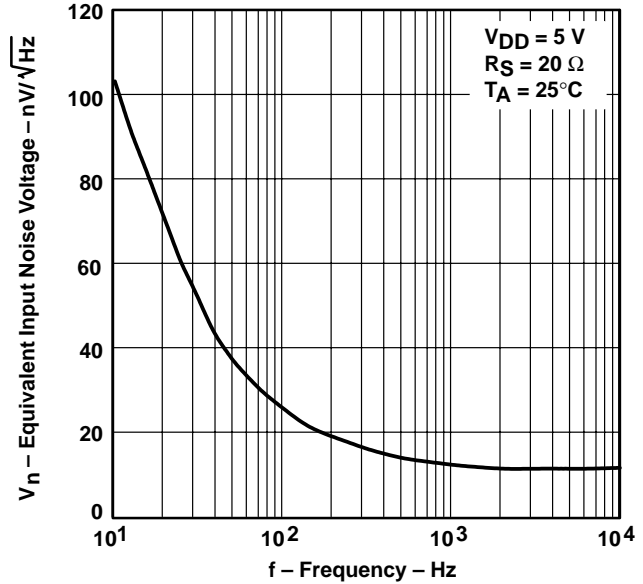

Figure 45

INPUT NOISE VOLTAGE OVER
 A 10-SECOND PERIOD†

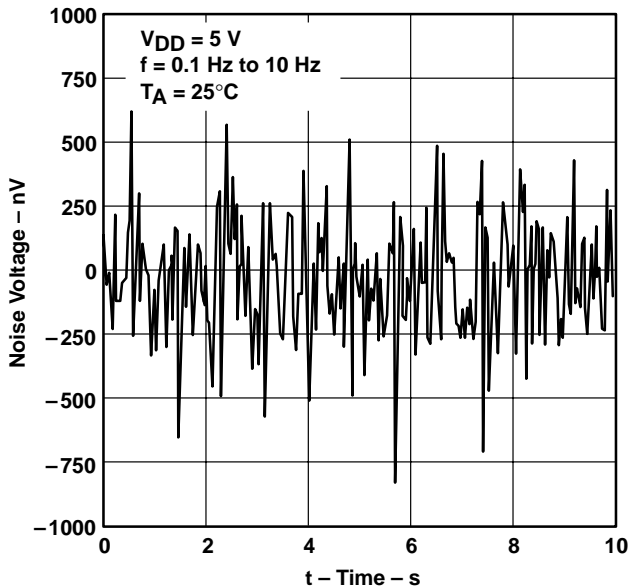

Figure 46

TOTAL HARMONIC DISTORTION PLUS NOISE†
 VS
 FREQUENCY

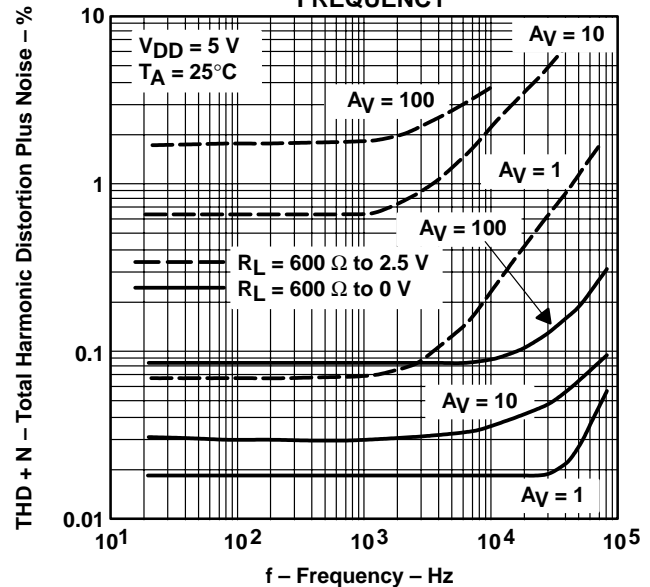

Figure 47

† For all curves where $V_{DD} = 5\text{ V}$, all loads are referenced to 2.5 V. For all curves where $V_{DD} = 3\text{ V}$, all loads are referenced to 1.5 V.

TYPICAL CHARACTERISTICS

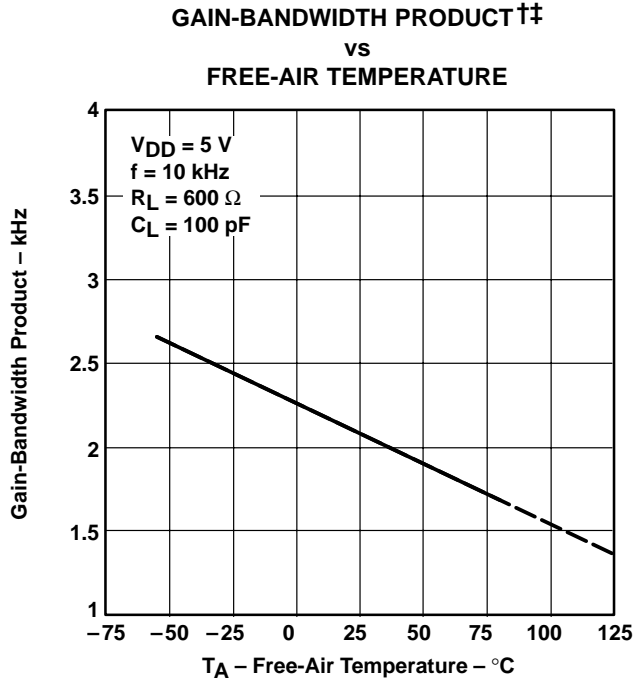

Figure 48

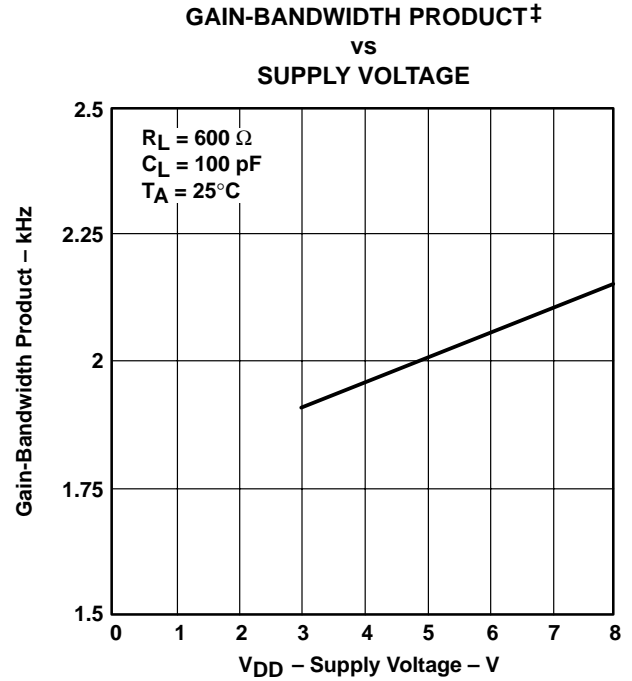

Figure 49

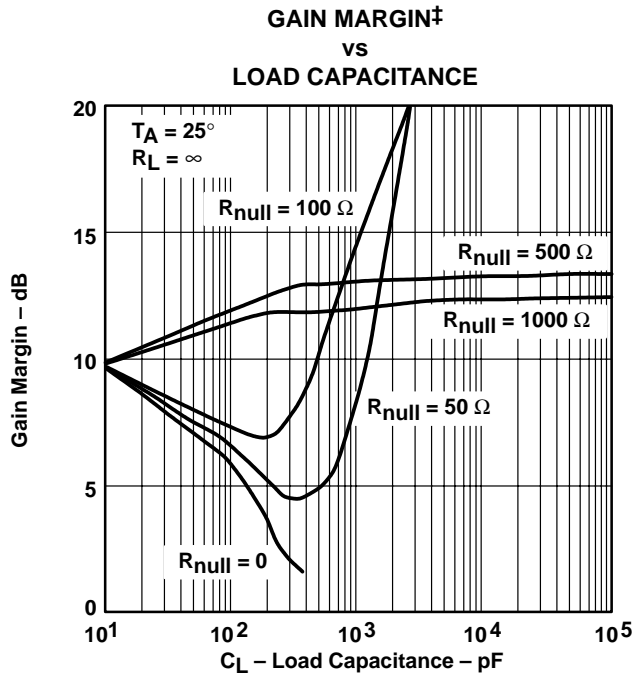

Figure 50

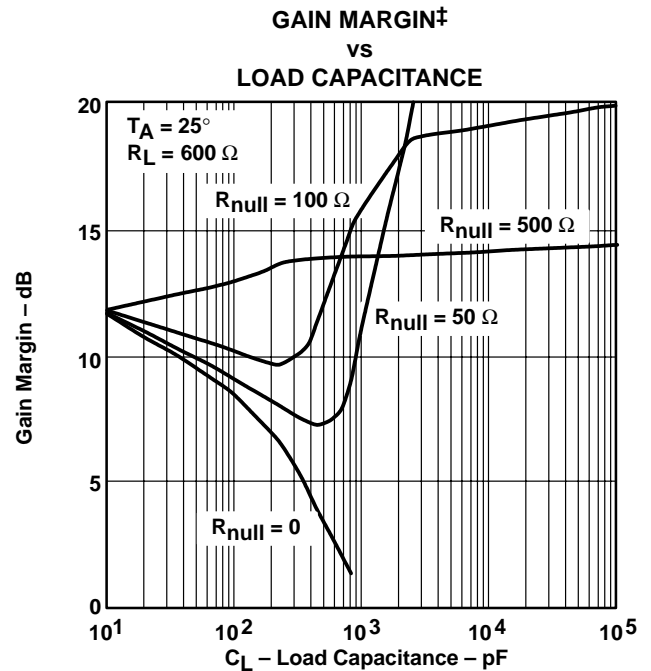

Figure 51

† Data at high and low temperatures are applicable only within the rated operating free-air temperature ranges of the various devices.

‡ For all curves where $V_{DD} = 5\text{ V}$, all loads are referenced to 2.5 V. For all curves where $V_{DD} = 3\text{ V}$, all loads are referenced to 1.5 V.

TYPICAL CHARACTERISTICS

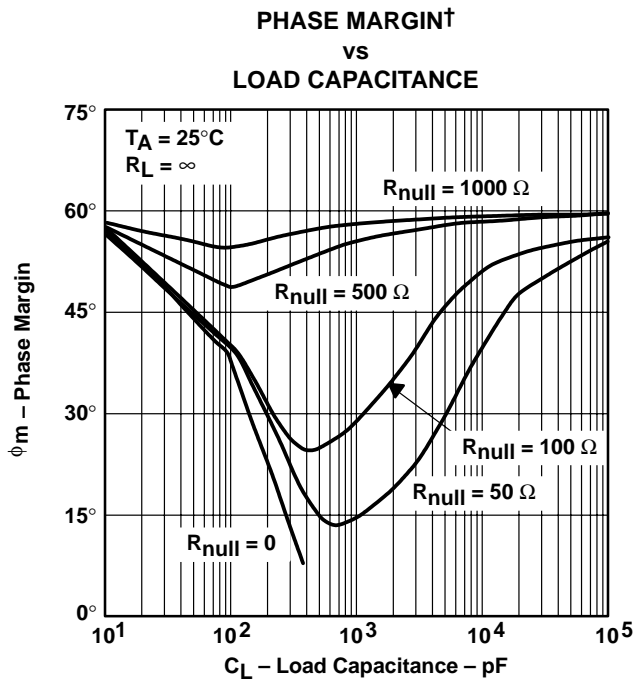

Figure 52

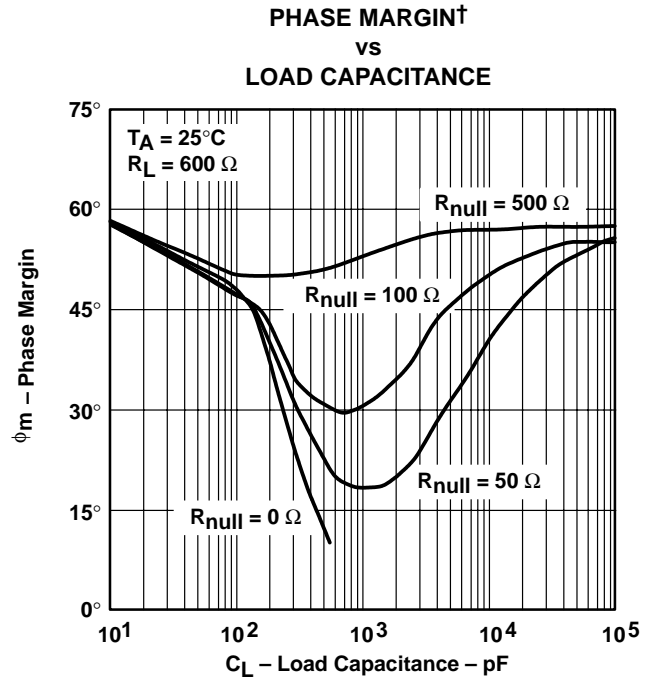

Figure 53

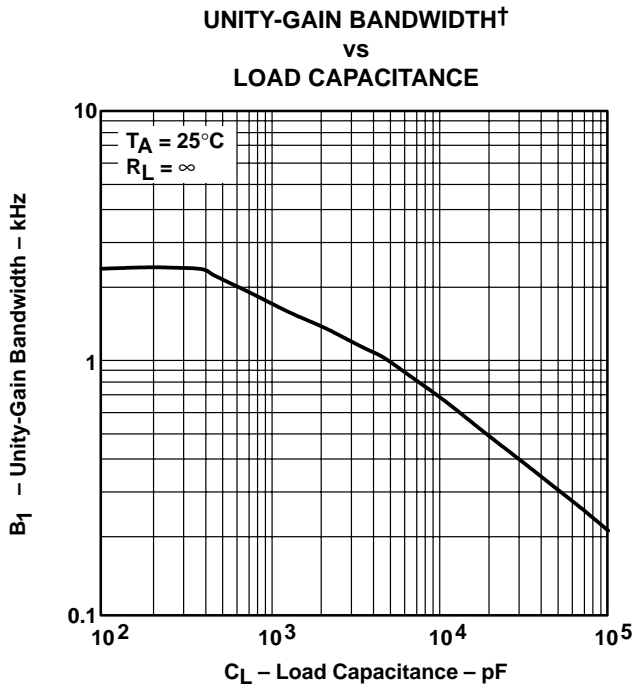

Figure 54

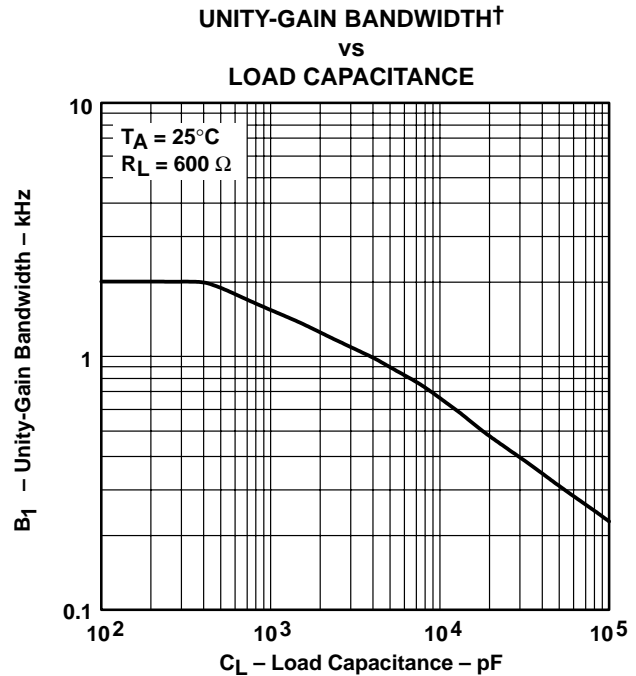

Figure 55

† For all curves where $V_{DD} = 5\text{ V}$, all loads are referenced to 2.5 V. For all curves where $V_{DD} = 3\text{ V}$, all loads are referenced to 1.5 V.

APPLICATION INFORMATION

driving large capacitive loads

The TLV2231 is designed to drive larger capacitive loads than most CMOS operational amplifiers. Figure 50 through Figure 55 illustrate its ability to drive loads greater than 100 pF while maintaining good gain and phase margins ($R_{null} = 0$).

A small series resistor (R_{null}) at the output of the device (see Figure 56) improves the gain and phase margins when driving large capacitive loads. Figure 50 through Figure 53 show the effects of adding series resistances of 50 Ω , 100 Ω , 500 Ω , and 1000 Ω . The addition of this series resistor has two effects: the first effect is that it adds a zero to the transfer function and the second effect is that it reduces the frequency of the pole associated with the output load in the transfer function.

The zero introduced to the transfer function is equal to the series resistance times the load capacitance. To calculate the approximate improvement in phase margin, equation 1 can be used.

$$\Delta\phi_{m1} = \tan^{-1} \left(2 \times \pi \times \text{UGBW} \times R_{null} \times C_L \right) \quad (1)$$

Where :

$\Delta\phi_{m1}$ = Improvement in phase margin

UGBW = Unity – gain bandwidth frequency

R_{null} = Output series resistance

C_L = Load capacitance

The unity-gain bandwidth (UGBW) frequency decreases as the capacitive load increases (see Figure 54 and Figure 55). To use equation 1, UGBW must be approximated from Figure 54 and Figure 55.

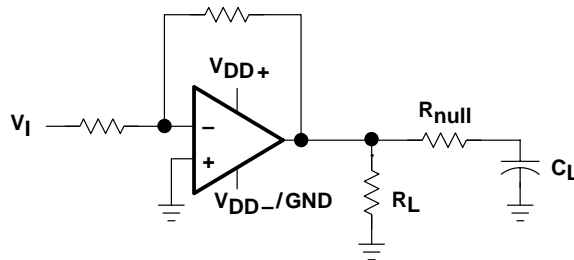

Figure 56. Series-Resistance Circuit

PACKAGING INFORMATION

Orderable Device	Status (1)	Package Type	Package Drawing	Pins	Package Qty	Eco Plan (2)	Lead finish/ Ball material (6)	MSL Peak Temp (3)	Op Temp (°C)	Device Marking (4/5)	Samples
TLV2231CDBVR	LIFEBUY	SOT-23	DBV	5	3000	RoHS & Green	NIPDAU	Level-1-260C-UNLIM	0 to 70	VAEC	
TLV2231CDBVT	LIFEBUY	SOT-23	DBV	5	250	RoHS & Green	NIPDAU	Level-1-260C-UNLIM	0 to 70	VAEC	
TLV2231IDBVR	ACTIVE	SOT-23	DBV	5	3000	RoHS & Green	NIPDAU	Level-1-260C-UNLIM	-40 to 85	VAEI	Samples
TLV2231IDBVT	LIFEBUY	SOT-23	DBV	5	250	RoHS & Green	NIPDAU	Level-1-260C-UNLIM	-40 to 85	VAEI	
TLV2231IDBVTG4	LIFEBUY	SOT-23	DBV	5	250	RoHS & Green	NIPDAU	Level-1-260C-UNLIM	-40 to 85	VAEI	

(1) The marketing status values are defined as follows:

ACTIVE: Product device recommended for new designs.

LIFEBUY: TI has announced that the device will be discontinued, and a lifetime-buy period is in effect.

NRND: Not recommended for new designs. Device is in production to support existing customers, but TI does not recommend using this part in a new design.

PREVIEW: Device has been announced but is not in production. Samples may or may not be available.

OBSELETE: TI has discontinued the production of the device.

(2) **RoHS:** TI defines "RoHS" to mean semiconductor products that are compliant with the current EU RoHS requirements for all 10 RoHS substances, including the requirement that RoHS substance do not exceed 0.1% by weight in homogeneous materials. Where designed to be soldered at high temperatures, "RoHS" products are suitable for use in specified lead-free processes. TI may reference these types of products as "Pb-Free".

RoHS Exempt: TI defines "RoHS Exempt" to mean products that contain lead but are compliant with EU RoHS pursuant to a specific EU RoHS exemption.

Green: TI defines "Green" to mean the content of Chlorine (Cl) and Bromine (Br) based flame retardants meet JS709B low halogen requirements of <=1000ppm threshold. Antimony trioxide based flame retardants must also meet the <=1000ppm threshold requirement.

(3) MSL, Peak Temp. - The Moisture Sensitivity Level rating according to the JEDEC industry standard classifications, and peak solder temperature.

(4) There may be additional marking, which relates to the logo, the lot trace code information, or the environmental category on the device.

(5) Multiple Device Markings will be inside parentheses. Only one Device Marking contained in parentheses and separated by a "-" will appear on a device. If a line is indented then it is a continuation of the previous line and the two combined represent the entire Device Marking for that device.

(6) Lead finish/Ball material - Orderable Devices may have multiple material finish options. Finish options are separated by a vertical ruled line. Lead finish/Ball material values may wrap to two lines if the finish value exceeds the maximum column width.

Important Information and Disclaimer:The information provided on this page represents TI's knowledge and belief as of the date that it is provided. TI bases its knowledge and belief on information provided by third parties, and makes no representation or warranty as to the accuracy of such information. Efforts are underway to better integrate information from third parties. TI has taken and continues to take reasonable steps to provide representative and accurate information but may not have conducted destructive testing or chemical analysis on incoming materials and chemicals. TI and TI suppliers consider certain information to be proprietary, and thus CAS numbers and other limited information may not be available for release.

In no event shall TI's liability arising out of such information exceed the total purchase price of the TI part(s) at issue in this document sold by TI to Customer on an annual basis.

TAPE AND REEL INFORMATION



QUADRANT ASSIGNMENTS FOR PIN 1 ORIENTATION IN TAPE

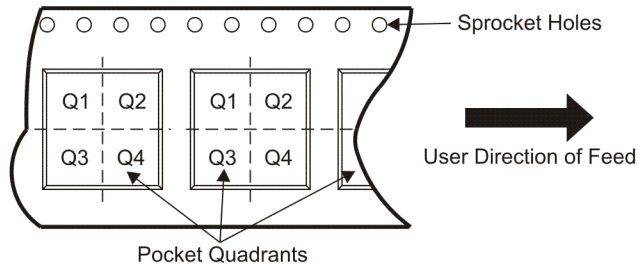

*All dimensions are nominal

Device	Package Type	Package Drawing	Pins	SPQ	Reel Diameter (mm)	Reel Width W1 (mm)	A0 (mm)	B0 (mm)	K0 (mm)	P1 (mm)	W (mm)	Pin1 Quadrant
TLV2231CDBVR	SOT-23	DBV	5	3000	180.0	9.0	3.15	3.2	1.4	4.0	8.0	Q3
TLV2231CDBVT	SOT-23	DBV	5	250	180.0	9.0	3.15	3.2	1.4	4.0	8.0	Q3
TLV2231IDBVR	SOT-23	DBV	5	3000	180.0	9.0	3.15	3.2	1.4	4.0	8.0	Q3
TLV2231IDBVT	SOT-23	DBV	5	250	180.0	9.0	3.15	3.2	1.4	4.0	8.0	Q3

TAPE AND REEL BOX DIMENSIONS



*All dimensions are nominal

Device	Package Type	Package Drawing	Pins	SPQ	Length (mm)	Width (mm)	Height (mm)
TLV2231CDBVR	SOT-23	DBV	5	3000	182.0	182.0	20.0
TLV2231CDBVT	SOT-23	DBV	5	250	182.0	182.0	20.0
TLV2231IDBVR	SOT-23	DBV	5	3000	182.0	182.0	20.0
TLV2231IDBVT	SOT-23	DBV	5	250	182.0	182.0	20.0

IMPORTANT NOTICE AND DISCLAIMER

TI PROVIDES TECHNICAL AND RELIABILITY DATA (INCLUDING DATA SHEETS), DESIGN RESOURCES (INCLUDING REFERENCE DESIGNS), APPLICATION OR OTHER DESIGN ADVICE, WEB TOOLS, SAFETY INFORMATION, AND OTHER RESOURCES "AS IS" AND WITH ALL FAULTS, AND DISCLAIMS ALL WARRANTIES, EXPRESS AND IMPLIED, INCLUDING WITHOUT LIMITATION ANY IMPLIED WARRANTIES OF MERCHANTABILITY, FITNESS FOR A PARTICULAR PURPOSE OR NON-INFRINGEMENT OF THIRD PARTY INTELLECTUAL PROPERTY RIGHTS.

These resources are intended for skilled developers designing with TI products. You are solely responsible for (1) selecting the appropriate TI products for your application, (2) designing, validating and testing your application, and (3) ensuring your application meets applicable standards, and any other safety, security, regulatory or other requirements.

These resources are subject to change without notice. TI grants you permission to use these resources only for development of an application that uses the TI products described in the resource. Other reproduction and display of these resources is prohibited. No license is granted to any other TI intellectual property right or to any third party intellectual property right. TI disclaims responsibility for, and you will fully indemnify TI and its representatives against, any claims, damages, costs, losses, and liabilities arising out of your use of these resources.

TI's products are provided subject to [TI's Terms of Sale](#) or other applicable terms available either on [ti.com](https://www.ti.com) or provided in conjunction with such TI products. TI's provision of these resources does not expand or otherwise alter TI's applicable warranties or warranty disclaimers for TI products.

TI objects to and rejects any additional or different terms you may have proposed.

Mailing Address: Texas Instruments, Post Office Box 655303, Dallas, Texas 75265
Copyright © 2023, Texas Instruments Incorporated